

**U.S. Department of Housing
and Urban Development**

Guidelines for the Evaluation and Control of Lead-Based Paint Hazards in Housing

**Office of Healthy Homes
and Lead Hazard Control
Second Edition, July 2012**



HEALTHYHOMES
Healthy Families | Healthy Children



U.S. Department of Housing and Urban Development

Guidelines for the Evaluation and Control of Lead-Based Paint Hazards in Housing

Office of Healthy Homes and Lead Hazard Control

Second Edition, July 2012



HEALTHYHOMES

Healthy Families | Healthy Children

**U.S. Department of Housing
and Urban Development**

Guidelines for the Evaluation and Control of Lead-Based Paint Hazards in Housing

**Office of Healthy Homes
and Lead Hazard Control
Second Edition, July 2012**



HEALTHYHOMES
Healthy Families | Healthy Children



Disclaimer

This document was prepared under contract to an agency of the United States Government. Neither the United States Government nor any of its employees makes any warranty, expressed or implied, or assumes any legal liability for any third party's use of, or the results of such use of, any information, product, or process discussed in this document. Mention or illustration of company or trade names or of commercial products does not constitute endorsement by the United States Government.

Acknowledgments

The U.S. Department of Housing and Urban Development thanks the many individuals who helped prepare the first and second editions of this document. Experts from the housing, public health, and environmental disciplines volunteered countless hours to provide the Nation with the best possible guidance. Due to their dedication and hard work, this document will further the effort to provide safe affordable housing and reduce childhood lead poisoning.

First Edition Contributors:

The principal author of the first edition was David E. Jacobs, of the National Center for Healthy Housing (NCHH; then the National Center for Lead-Safe Housing, or NCLSH). The contributing authors were: Scott Clark, David Cox, Gary Dewalt, Mark Farfel, Walter G. Farr, Norman Fay, Susan Guyaux, Ron Jones, Jim Keck, Barbara Leczynski, Miles Mahoney, Andrew Nelson, Pat McLaine, Sharon C. Park, Brad Prenney, Don Ryan, Bob Santucci, John Scalera, Dick Schmehl, Aaron Sussell, Ellen Tohn, Steve Weitz, and Jonathan Wilson. The members of the Federal Steering Committee were: Steve Weitz, Chair, HUD; Dave Jacobs, Secretary, NCLSH; Rick Brandes, EPA; Brion Cook, EPA; Nick Farr, NCLSH; Mark Henshall, EPA; Samuel Hodges, III, FmHA; Lewis Ligon, Jr., OSHA; Mary McKnight, NIST; Arthur Newburg, HUD; Carolyn Newton, HUD; Gary Noonan, CDC; John Schwemberger, EPA; Dianne Sheridan, EPA; Linda Walker, VA; Bill Wisner, HUD; and Hugh Wolfe, DoD. The Technical Editor was Judy LaKind. The Copy Editors were Caroline S.A. Baker, Robin Gurley, and Aspen Systems Corporation. The Graphic Designers were David L. Schmidt, Stephanie L. Melis, Grant Hutchins, and Aspen Systems Corporation. The reviewers were: Vicki Ainslie, Jim August, Tracy Barlow, Sue Binder, Karen Blume, Lynn Boulay, Dave Burgoon, David Bussard, Bruce Buxton, Patrick Connor, John Dement, Gary Dewalt, Denny Dobbin, Pierre Erville, Charles Hartwig, Karen Florini, Michael Godfrey, Andrew Goodman, Jeanne Gorman, Sharon Harper, Steve M. Hays, Ron Jones, Fred Kalvelage, John Kinateder, Barbara Leczynski, Linda Lewis, Ben Lim, Bob Lordo, Tom Matte, John McCarthy, John McCauley, Ron Menton, John Menkedick, Beth Moore, John Moran, Rick Rinehart, John Rogers, Steve Rust, Joan Ryan, Mary Ann Russ, Joe Schirmer, Thomas J. Schruben, Brad Schultz, Steve Sides, Kenn White, Neil Wilson, John Zilka, and Ralph Zumwalde. Special thanks go to Evelyne Bloomer, who contributed many hours typing and formatting the First Edition.

Second Edition Contributors:

The first draft of this Second Edition of the HUD *Guidelines for the Evaluation and Control of Lead-Based Paint Hazards in Housing* was prepared by the National Center for Healthy Housing. ICF International, Inc., provided editorial support. HUD staff completed the revision, with external reviews by Kevin Ashley, CDC; Richard Baker, Baker Environmental; Mary Jean Brown, CDC; Scott Clark, U. of Cincinnati; Gary Dewalt, QuanTech; Karl Duff, Liability Consultants, LLC; Marc Edmond, EPA; Chuck Fisher, NPS; Thomas Galassi, OSHA; Mark Henshall, EPA; David E. Jacobs, NCHH; Larry McGowan, OSHA; Rebecca L. Morley, NCHH; Ron Morony, EPA; Jackie Mosby, EPA; Aaron Sussell, CDC; Donna Thomas, USDA; Lee E. Wasserman, LEWCorp; Kenneth T. White, Consultive Services; and Jonathan Wilson, NCHH; and internal HUD reviews including those by Peter J. Ashley, Nancy Boone, Warren Friedman, Bruce P. Haber, Lee Ann Richardson, Eugene A. Pinzer, Rachel M. Riley, John B. Shumway, and Robert F. Weisberg. Atrium Environmental Health and Safety Services, LLC, and Sagetopia performed the formatting and layout of the Second Edition for posting by HUD on the HUD Healthy Homes website at www.hud.gov/offices/lead/guidelines/hudguidelines/index.cfm.

Photo Credits:

HUD gratefully acknowledges the following individuals and grantees for contributing the photographs used in this document: Aaron Sussell, Centers for Disease Control and Prevention/National Institute for Occupational Safety and Health; Department of the Interior/National Park Service; Alameda County Lead Poisoning Prevention Program; City of Burlington, VT, Community and Economic Development Office; State of California Lead Hazard Control Program; Coalition to End Childhood Lead Poisoning, Baltimore, MD; Lowell, MA, Lead Abatement Program; City of Manchester, CT, Lead Hazard Control Program; Monroe County, NY, Lead Hazard Control Program; City of Syracuse Lead Poisoning Prevention Program; State of Vermont Lead Hazard Control Program; Rex Smith, Risk Assessor, W.I.P.E., Wichita, Kansas; and John R. Zilka, Applied Systems, Inc., Aliquippa, PA.

HUD acknowledges the photographs, drawings and other information contributed by its lead hazard control grantees over the years, which greatly helped in the development of this edition of the *Guidelines*. HUD notes that the pictures reflect actual field conditions, that some of them show conditions or practices that do not meet current standards and recommendations, and that those standards and recommendations may have changed since the pictures were created and may change further over time.

Preface

The U.S. Department of Housing and Urban Development's (HUD's) *Guidelines for the Evaluation and Control of Lead-Based Paint Hazards in Housing* (the "*Guidelines*") provide detailed, comprehensive technical information on how to identify lead-based paint and related hazards in housing, and how to control such hazards safely and efficiently. The purpose of this document is to help property owners, government agencies, and private contractors sharply reduce childhood exposure to lead without unnecessarily increasing the cost of housing.

The *Guidelines* are issued pursuant to Section 1017 of the Residential Lead-Based Paint Hazard Reduction Act of 1992, which is often referred to as Title X ("title ten") because it was enacted as Title X of the Housing and Community Development Act of 1992 (Public Law 102-550). The *Guidelines* are based on the concepts, definitions, and requirements set forth by Congress in Title X.

Section 1017 requires the HUD Secretary to issue "guidelines for the conduct of *federally supported work* involving risk assessments, inspections, interim controls, and abatement of lead-based paint hazards" (emphasis added, see 42 U.S.C. 4852c). Therefore, the primary purpose of this document is to provide guidance to people involved in identifying and controlling lead-based paint hazards posed by paint, dust, and soil in housing that is associated with the Federal Government. The *Guidelines* may also be useful to individuals in housing that has no connection with the Federal government, as well as day-care centers and public buildings that exhibit conditions similar to those in residential structures.

This second edition of the *Guidelines* replaces the edition that was issued by HUD under the auspices of the Office of Healthy Homes and Lead Hazard Control (OHHLHC) in 1995. This edition of the *Guidelines* is applicable to lead hazard evaluation and control in *all* federally associated housing.

The *Guidelines* are consistent with the OHHLHC vision to "lead the nation to a future where homes are both affordable and designed, constructed, rehabilitated, and maintained in a manner that supports the health and safety of occupants," and its mission to "*reduce health and safety hazards in housing in a comprehensive and cost-effective manner, with a particular focus on protecting the health of children and other sensitive populations in low-income households.*"

The *Guidelines* complement regulations and other directives and guidelines that have been issued by HUD, the U.S. Environmental Protection Agency, the Occupational Safety and Health Administration, Consumer Product Safety Commission, National Park Service, and the Centers for Disease Control and Prevention. Other Federal agencies, as well as some State and local governments, have also issued regulations and other directives pertaining to housing under their jurisdiction. Regulations generally specify minimum requirements for: *what* must be done and *when*; training and, if applicable, certification for those conducting the work; and certain basic standards for *how* work must be done. The *Guidelines* generally provide more detailed information than regulations on *how* activities related to lead-based paint should be carried out and *why* certain measures are recommended.

While compliance with *Guidelines* is not required by law, a Federal, State, or local statute, regulation, legal agreement or other document may require that the *Guidelines*, or certain parts, be followed. Where the *Guidelines* differ from a more stringent or protective Federal, State or local regulation, the more stringent regulation must be followed.

Readers should be aware that lead hazard control is a rapidly changing field; new products, methods, procedures, and standards are introduced frequently. Therefore, the *Guidelines* will be further updated as research and experience provide new information, as technology advances, and as Federal regulations are revised.



Similarly, while the website addresses in this edition of the *Guidelines* were verified shortly before publication, some of them will change over time, and additional websites of interest will be created. If a particular site is no longer valid or is outdated, a higher-level page may be checked (e.g., starting a search at www.abcdefg.gov, when www.abcdefg.gov/hijkl is invalid or no longer useful), or a web search engine looking for the term(s) of interest may be tried.

HUD welcomes comments and suggestions on ways to improve these *Guidelines*. Please send written comments to:

Director, Office of Healthy Homes and Lead Hazard Control

U.S. Department of Housing and Urban Development

451 Seventh Street SW, Room 8236

Washington, DC 20410-3000

Lead.Regulations@HUD.gov

The introductory chapter explains further the legislative basis for the *Guidelines*, the intended readership, and the relationship of the *Guidelines* to Federal regulations. The chapter also includes a brief summary of the problem of childhood lead poisoning, an explanation of the basic concepts that underlie the methods and procedures set forth in the *Guidelines*, and a description of how the document is structured.

Table Of Contents: Guidelines 2nd Edition

ACKNOWLEDGEMENTS iii

PREFACE..... v

CHAPTERS

Chapter 1	Introduction.....	1-1
Chapter 2	Where to Go for Help – Qualifications, Roles and Resources.....	2-1
Chapter 3	Before You Begin – Planning To Control Lead Hazards	3-1
Chapter 4	Lead-Based Paint and Housing Renovation	4-1
Chapter 5	Risk Assessment and Reevaluation	5-1
Chapter 6	Ongoing Lead-Safe Maintenance	6-1
Chapter 7	Lead-Based Paint Inspection	7-1
Chapter 8	Resident Protection and Worksite Preparation.....	8-1
Chapter 9	Worker Protection	9-1
Chapter 10	Housing Waste	10-1
Chapter 11	Interim Controls.....	11-1
Chapter 12	Abatement	12-1
Chapter 13	Abatement by Encapsulation	13-1
Chapter 14	Cleaning	14-1
Chapter 15	Clearance.....	15-1
Chapter 16	Investigation and Treatment of Dwellings that House Children with Elevated Blood Lead Levels	16-1
Chapter 17	(Reserved for future use)	17-1
Chapter 18	Lead-Based Paint and Historic Preservation	18-1

GLOSSARY..... G-1

APPENDICES

Appendix 1	Units of Measure Used in the Lead-Based Paint Field.....	APP 1-1
Appendix 2	CDC’s Childhood Lead Poisoning Prevention Program.....	APP 2-1
Appendix 3	U.S. EPA Regional Offices	APP 3-1
Appendix 4	OSHA Regional Offices and State Programs	APP 4-1
Appendix 5	EPA Training, Certification and Accreditation Programs	APP 5-1
Appendix 5.1	Structured On-the-Job Training (OJT) vs. Unstructured OJT	APP 5.1-1
Appendix 6	HUD, EPA, OSHA, CPSC, and NPS Lead Paint Rules	APP 6-1
Appendix 7.1	(Reserved for future use)	APP 7.1-1



Appendix 7.2	Types of Lead-Based Paint Enclosure Systems	APP 7.2-1
Appendix 7.3	Generic Lead Based Paint Specifications	APP 7.3-1
Appendix 7.4	Guidance on Specifications for Interim Control of Soil Lead Hazards	APP 7.4-1
Appendix 8.1	Example of a Pre-Rehabilitation Risk Assessment and Limited Paint Testing Report for a Single-Family Dwelling Operated By a Small-Scale Owner.....	APP 8.1-1
Appendix 8.2	Example of a Risk Assessment Report for Large Multi-family Housing Development	APP 8.2-1
Appendix 9	Lead-Based Paint Liability Insurance	APP 9-1
Appendix 10	(Reserved for future use)	APP 10-1
Appendix 10.1	State and Territorial Hazardous Waste Management Agencies	APP 10.1-1
Appendix 11	One -Hour Waiting Period Rationale for Clearance Sampling.....	APP 11-1
Appendix 12	Statistical Rationale for Sample Sizes and Percentages Used in Guidance for Inspecting in Multi-Family Housing.....	APP 12-1
Appendix 13.1	Wipe Sampling of Settled Dust for Lead Determination	APP 13.1-1
Appendix 13.2	Paint Chip Sampling.....	APP 13.2-1
Appendix 13.3	Collecting Soil Samples for Lead Determination	APP 13.3-1
Appendix 13.4	(Reserved for future use)	APP 13.4-1
Appendix 13.5	EPA Information on Drinking Water	APP 13.5-1
Appendix 14.1	EPA-Recognized Laboratories for Analysis of Lead in Paint, Dust and Soil	APP 14.1-1
Appendix 14.2	(Reserved for future use)	APP 14.2-1
Appendix 14.3	Procedure for the Preparation of Field Spiked Wipe Samples	APP 14.3-1
Appendix 15	OSHA Lead in Construction Guidance.....	APP 15-1
Appendix 16	CDC Guidance on Lead Poisoning Prevention	APP 16-1

FIGURES

Figure 1.1	Some paints contained 50% lead and were aggressively marketed.....	1-6
Figure 1.2	Deteriorated residential paint on house trim.....	1-7
Figure 1.3	Paint deterioration	1-7
Figure 1.4	Title X’s Lead Hazard Control Framework.....	1-11
Figure 2.1	Many local health departments distribute information or conduct outreach activities at health fairs or community meetings	2-10
Figure 2.2	Risk assessors and property owners planning housing rehabilitation may find an on-site meeting facilitates communication about lead-based paint hazards on a property	2-14
Figure 3.1	Assessing the physical condition of a property.....	3-8



Figure 3.2	HUD’s American Healthy Homes Survey found that, in 2005–2006, most pre-1940 units contained some lead-based paint	3–9
Figure 3.3	Worker caulking painted surfaces as part of ongoing lead-safe maintenance.....	3–11
Figure 3.4	Units with children have a higher priority for evaluation and control than other units	3–12
Figure 3.5	Determination of Lead Hazard Control Strategy: Decision-making Logic.....	3–15
Figure 4.1	Sanding wooden floors can generate significant amounts of dust.....	4–4
Figure 4.2	Torching and burning old paint is a prohibited work practice that can generate lead fumes.....	4–6
Figure 4.3	This worksite was not properly prepared for lead-disturbing work by removing the occupant’s belongings.	4–10
Figure 4.4	HEPA vacuuming is an important step in the specialized cleaning process	4–10
Figure 5.1	Lead Hazard Screen Decision Logic.	5–12
Figure 5.2	Risk Assessor interviewing a resident.....	5–20
Figure 5.3	Record of sampling locations and floor plan sketch.	5–21
Figure 5.4	Forms of Paint Deterioration	5–25
Figure 5.4a	Peeling paint	5–25
Figure 5.4b	Alligatoring paint.....	5–25
Figure 5.4c	Blistering paint	5–25
Figure 5.5	Baseboard showing deteriorated paint less than the de minimis amounts.	5–28
Figure 5.6a	Friction hazard on stairs pre-treatment.....	5–30
Figure 5.6b	Friction hazard on stairs post-treatment.	5–30
Figure 5.7	Impact surface on door and frame.....	5–31
Figure 5.8	Chewable surface showing teeth marks on window sill.....	5–32
Figure 5.9	Soil lead hazard at dripline.....	5–32
Figure 5.10	Soil lead hazard at dripline of garage.	5–34
Figure 5.11a	Dust sampling equipment.	5–37
Figure 5.11b	Pulling a wipe from container.....	5–37
Figure 5.11c	Making first (horizontal) pass of clearance wipe.	5–37
Figure 5.11d	Folding wipe.....	5–37
Figure 5.11e	The second (vertical) pass.	5–37
Figure 5.11f	Placing the used wipe into hard container.....	5–37
Figure 5.12	Floor sampling in high traffic area near entry.	5–39
Figure 5.13	Window sill and trough.	5–40



Figure 5.14	Illustrations of window trough and interior window sill.	5–41
Figure 5.15	Example of basic dust sampling plan.....	5–43
Figure 5.16	Dust testing window sill for presence of friction hazard.....	5–44
Figure 5.17	Damage to painted surface caused by paint chip sampling.....	5–52
Figure 5.18	Baby’s bed exhibiting deteriorated paint and evidence of teeth marks.	5–53
Figure 5.19a-c	Soil sampling.	5–55
Figure 5.20	Example of targeted dwelling selection.	5–74
Figure 5.21	Example of soil hazard determination in non-play areas.	5–78
Figure 5.22	Example of lead hazard control policy.....	5–83
Figure 6.1	Visual Assessment	6–9
Figure 6.2	Opening screen from HUD's first on-line visual assessment training curriculum. Updates may occur.	6–11
Figure 6.3	An area of bare soil beneath a window with deteriorated paint.	6–14
Figure 6.4	Bare soil in Figure 6.3 covered with mulch (the window was sealed during the process of controlling the bare soil).....	6–23
Figure 6.5	Unit turnover is an excellent time to conduct the visual assessment and perform lead safe maintenance activities.	6–27
Figure 6.6	Clean up supplies.	6–32
Figure 7.1	One type of XRF instrument displays its reading of a testing combination	7–12
Figure 7.2	Child’s bed showing teeth marks in painted surface	7–21
Figure 7.3	Multi-family Decision Flowchart	7–43
Figure 7.4	Preparation to take paint chip sample	7–46
Figure 7.5	Removing paint chip sample	7–46
Figure 7.6	Damage caused by removing paint chip sample	7–47
Figure 7.7	Inspectors must operate XRFs at a safe distance from others.....	7–52
Figure 8.1	Prohibiting resident entry into work area by use of containment barrier.	8–5
Figure 8.2	EPA’s “Renovate Right” Pamphlet.	8–7
Figure 8.3	Structural deficiency.	8–8
Figure 8.4	Example of structural deficiency needing repair prior to work.....	8–8
Figure 8.5	One example of a commercial-type HEPA vacuum.	8–9
Figure 8.6	Inadequate worker protection during a large overhead paint stripping project.	8–9
Figure 8.7	Placing coffee station in the work area is an unsafe work practice.	8–9
Figure 8.8	Floor plastic in work area.	8–15
Figure 8.9	Plastic barrier between living space and work area.....	8–16



Figure 8.10	Interior warning sign.	8-17
Figure 8.11	Exterior warning sign for project shown in Figure 8.10.	8-17
Figure 8.12	Items that are too large to move should be sealed completely and taped.....	8-19
Figure 8.13	Removal and wrapping contaminated carpet.	8-20
Figure 8.14	Exterior containment of polyethylene sheeting lines the narrow walkway between two houses.	8-25
Figure 8.15	Exterior containment on building and window; ladder kept on plywood.	8-25
Figure 8.16	Example of barrier tape used as an occupant protection measure	8-26
Figure 8.17	Pre-cleaning window with HEPA vacuum.....	8-27
Figure 8.18	Sample Informed Consent Form for Residents of Housing for the Elderly.....	8-31
Figure 10.1	Separate waste into categories during work	10-4
Figure 10.2	Radiators and trim are examples of intact architectural components that are low-level lead waste.....	10-6
Figure 10.3	Concentrated lead waste.	10-8
Figure 10.4	Paint chips should be double-bagged and seams sealed.	10-8
Figure 10.5	EPA regulates disposal of hazardous waste	10-9
Figure 11.1	Moisture-Related Causes of Paint Failure	11-24
Figure 11.2	HEPA Vacuum Sanders.....	11-30
Figure 11.3	Window before and after friction treatment.....	11-35
Figure 11.4	Examples of impact and chewable surfaces	11-36
Figure 11.5	Prepare the worksite and pre-clean the window	11-37
Figure 11.6	Remove parting bead.....	11-37
Figure 11.7	Remove the bottom sash, sash weights and stops	11-38
Figure 11.8	Remove sash controls/weights.....	11-38
Figure 11.9	Window after removal of sash weights	11-38
Figure 11.10	Rebuild damaged sash with filler or putty	11-38
Figure 11.11	Wet plane edges of sash to fit new jamb liners	11-38
Figure 11.12	Vacuum window again.....	11-38
Figure 11.13	Fit sashes into jamb liners	11-39
Figure 11.14	Reinstall sash into jamb	11-39
Figure 11.15	Stabilizing paint on doors: Wet planning and wet sanding	11-40
Figure 11.16	Before and after stair treatments	11-41
Figure 11.17	Covering Stairs with Tread Guards.....	11-42



Figure 11.18	Shoe Molding Is an Acceptable Impact Surface Treatment for Baseboards.....	11-42
Figure 11.19	Corner Bead Coverings Can Be Used on Outside Corners of Walls.....	11-42
Figure 11.20	Turning a Window Sill and Trough Into a Smooth and Cleanable Surface.....	11-48
Figure 11.21	How to Use a HEPA Vacuum	11-52
Figure 11.22	Changing HEPA vacuum filter	11-54
Figure 11.23	Carpet with debris and after cleaning.....	11-58
Figure 11.24	Air vent before and after cleaning	11-59
Figure 11.25	Clean Air Vent Registers.....	11-59
Figure 11.26	Walk-Off Mats	11-60
Figure 11.27	Thorny Bushes as a Land Use Control.....	11-65
Figure 11.28	Using Fencing as an Interim Control.....	11-65
Figure 12.1	Removing and Replacing Trim: interior (left), exterior (right)	12-19
Figure 12.2	Protecting the interior of a unit for exterior window abatement	12-20
Figure 12.3	Replacement window system.....	12-20
Figure 12.4	Pre-and post-abatement interior doors	12-21
Figure 12.5	A metal railing before abatement.....	12-22
Figure 12.6	Installation of replacement siding	12-22
Figure 12.7	Certified workers are needed to replace siding when the project's intent is lead abatement.....	12-22
Figure 12.8	Line surfaces with plastic in the work area (left) and pathways (right).....	12-23
Figure 12.9	Example of a Diagram Showing the Location of Lead-Based Paint Enclosures	12-25
Figure 12.10	Installing underlayment and new flooring as a suitable LBP enclosure method.....	12-29
Figure 12.11	Enclosed stairs.....	12-30
Figure 12.12	Seal All Seams for Enclosure	12-31
Figure 12.13	Prohibited work practices (traditional abrasive blasting (left) and grinding without HEPA exhaust)	12-34
Figure 12.14	Using a heat gun to remove paint is labor-intensive.....	12-36
Figure 12.15	HEPA-filtered power tools.....	12-37
Figure 12.16	Wet scraping (left)	12-38
Figure 12.17	Scraping tools (right).....	12-38
Figure 12.18	Vacuum blasting is not often used on housing	12-39
Figure 12.19	Needle Gun with HEPA Exhaust Ventilation	12-39



Figure 12.20	Workers should wear protective clothing when using chemicals	12-40
Figure 12.21	Eye- and body-wash stations are required when working with corrosive or irritant chemicals.....	12-41
Figure 12.22	Replacing resident pathway after soil removal	12-47
Figure 12.23	Preparing to pave high traffic area.....	12-49
Figure 13.1	Encapsulating a floor with vinyl tiles	13-8
Figure 13.2	Deteriorated paint on surfaces that are unsuitable for encapsulation.	13-8
Figure 13.3	Encapsulated historic components.	13-13
Figure 13.4	Encapsulant failure.	13-21
Figure 14.1	There are many brands of HEPA vacuums on the market.....	14-8
Figure 14.2	Vacuum with a HEPA filter and special attachments.....	14-10
Figure 14.3	Sizes of HEPA vacuums and attachments.	14-11
Figure 14.4	Three-bucket cleaning system.....	14-13
Figure 14.5	HEPA vacuum and wet wash technology.	14-13
Figure 14.6	Removing large debris.	14-15
Figure 14.7	Exterior clean up.	14-16
Figure 14.8	Vacuuming the floor containment.....	14-17
Figure 14.9	Inspecting for completeness of the work performed.	14-19
Figure 14.10	The HEPA Vacuum-Wet Wash-HEPA Vacuum Cycle Helps Meet Clearance Standards.....	14-20
Figure 14.11	Wet Cycle Requires Washing All Surfaces with Suitable Detergents.	14-20
Figure 14.12	Use a Three-Bucket System and Then HEPA Vacuum Again to Minimize Recontamination	14-20
Figure 14.13	HEPA vacuum all surfaces a final time.....	14-20
Figure 15.1	Windows sealed to prevent dust migration	15-13
Figure 15.2	Visible paint chips and debris in soil	15-14
Figure 15.3	Visible dust Indicates recleaning is needed	15-19
Figure 15.4	Tracking of dust that may contain lead	15-19
Figure 15.5	Indications that children are present.....	15-26
Figure 15.6	A floor that may be tested	15-30
Figure 15.7	A windowsill and trough that may be tested	15-30
Figure 15.8	Window locations for dust sampling.....	15-31
Figure 15.9	Soil debris.....	15-34
Figure 15.10	Surfaces that may have been paint stripped.....	15-37



Figure 16.1	Health Department case managers work with parents and guardians of lead-poisoned children	16-6
Figure 16.2	Environmental investigations include sites where the child spends time	16-8
Figure 18.1	Delicate muntins and multi-pane sash on row houses	18-9
Figure 18.2	Window condition assessment.....	18-9
Figure 18.3a	Historic property before rehabilitation	18-10
Figure 18.3b	Historic property after rehabilitation.....	18-10
Figure 18.4	Wood features on historic properties	18-12
Figure 18.5	Doors to historic property before off-site stripping.....	18-13
Figure 18.5b	Doors to historic property after off-site stripping.....	18-13
Figure 18.6	Enclosure of stairs not appropriate in a historic property.....	18-14

FORMS

Form 5.0	Questionnaire for a Lead Hazard Risk Assessment of an Individual Occupied Dwelling Unit.	5-99
Form 5.1	Building Condition Form for Lead Hazard Risk Assessment.....	5-101
Form 5.2	Field Report of Visual Assessment for Lead Hazard Risk Assessment.....	5-102
Form 5.3	Field Paint Chip Sampling Form	5-103
Form 5.4a	Field Sampling Form for Dust. (Single-Surface Sampling)	5-104
Form 5.4b	Field Sampling Form for Dust. (Composite Sampling)	5-105
Form 5.5	Field Sampling Form for Soil.....	5-106
Form 5.6	Questionnaire for a Lead Hazard Risk Assessment of More Than Four Rental Dwelling Units.....	5-107
Form 5.7	Format for an Executive Summary of a Lead Hazard Risk Assessment.	5-111
Form 6.0	Report of Visual Assessment (for Ongoing Lead-Safe Maintenance).....	6-35
Form 6.1	Report of Visual Assessment of Bare Soil for Lead-Safe Maintenance	6-36
Form 6.2	Log of Visual Assessments for Ongoing Lead-Safe Maintenance	6-37
Form 6.3	Lead-Based Paint Inventory.....	6-38
Form 6.3a	Completed Lead-Based Paint Inventory for a Room/Space	6-39
Form 6.4	Lead Hazard Control Inventory	6-40
Form 6.5	Lead-Safe Maintenance Work Order.....	6-41



Lead-Based Paint Inspection Forms	After 7–61
Form 7.1	Single Family Housing LBP Testing Data Sheet – Blank
Form 7.1	Single Family Housing LBP Testing Data Sheet – Completed
Form 7.2	Calibration Check Test Results – Blank
Form 7.2	Calibration Check Test Results – Completed
Form 7.3	Substrate Correction Values – Blank
Form 7.3	Substrate Correction Values – Completed
Form 7.4	Selection of Housing Units – Blank
Form 7.4	Selection of Housing Units – Completed
Form 7.5	Multi-family Housing LBP Testing Data Sheet – Blank
Form 7.5	Multi-family Housing LBP Testing Data Sheet – Completed
Form 7.6	Multi-family Housing: Component Type Report – Blank
Form 7.6	Multi-family Housing: Component Type Report – Completed
Form 13.1	Encapsulant Patch Test Documentation..... 13–23
Form 13.2	Lead-Based Paint Encapsulation Visual Monitoring Form 13–27
Form 15.1	Visual Assessment - Lead Hazard Clearance Examination..... 15–45
Form 15.2	Field Sampling Form for Dust - Lead Hazard Clearance Examination (single-surface sampling)..... 15–46
Form 15.3	Lead Hazard Clearance Report – Completed Example 15–47
Form 15.4	Clearance Report Review Worksheet..... 15–53
Form 15.5	Clearance Report Review Worksheet – Completed Example..... 15–54
Form 16.1	Resident Questionnaire for Investigation of Children with Elevated Blood Lead Levels (EBL) 16–23

TABLES

Table 2.1	Owner Responsibilities..... 2–4
Table 3.1	Summary of Steps in Planning Lead Hazard Control Projects 3–7
Table 3.2	Housing Units with Lead-Based Paint or Significant Lead-Based Paint Hazards 3–9
Table 4.1	Similarities between Lead Hazard Control and Renovation..... 4–5
Table 5.1	Comparison of Risk Assessment, Lead Hazard Screen, Lead-Based Paint Inspection, and Combination Inspection/Risk Assessment 5–10
Table 5.2	Percentage of Housing Units with Significant Lead-Based Paint Hazards, and Percentage with Bare Soil Lead Levels in Yard > 1200 ppm, United States, 2005-2006 5–14
Table 5.3	Percentage of Component Types Coated with Lead-Based Paint, by Year of Construction, and by Interior or Exterior Location, United States, 2000 5–16



Table 5.4	Illustrative List of Painted Components*	5–27
Table 5.5	Review of Previous Lead-Based Paint Inspections.	5–50
Table 5.6	Recommended Number of Play Areas To Be Sampled.	5–57
Table 5.7	Recommended Number of Non-play Areas of Dripline/Foundation Areas.....	5–58
Table 5.8	Recommended Number of Soil Samples in Non-play Areas of the Rest of the Yard Outside of Dripline/Foundation Areas.....	5–59
Table 5.9	Risk Assessment Approach for Evaluations of Different Size.....	5–63
Table 5.10	Minimum Number of Targeted Dwellings to Be Sampled Among Similar Dwellings (random sampling may require additional units).	5–68
Table 5.11	Federal Hazard Levels for Lead Hazard Risk Assessments*	5–73
Table 5.12	Main Hazard Control Options That Could Be Identified in Risk Assessments Based on Actual Conditions.	5–87
Table 5.13	Paint-Lead Hazards.....	5–92
Table 5.14	Soil-Lead Hazards.....	5–92
Table 5.15	Dust-Lead Hazards	5–93
Table 7.1	Examples of Interior and Exterior Building Component Types.....	7–18
Table 7.2	Examples of Distinct Testing Combinations.....	7–19
Table 7.3	Number of Units to Be Tested in Multi-family Building and Developments.....	7–38
Table 8.1	Interior Worksite Preparation (Not Including Windows)	8–13
Table 11.1	Finish Coats for Paint Stabilization.....	11–32
Table 11.2	Sticky Tape Technique for Removing Loose Paint on Impact Surfaces for Owner/Occupants or Residents.....	11–43
Table 11.3	Potential Sources of Lead-Containing House Dust.....	11–46
Table 11.4	Major Dust Reservoirs and Potential Dust Traps.....	11–47
Table 11.5	Rug Cleaning Steps and Approximate Time Per 10 Square Feet.....	11–57
Table 11.6	Grasses and Their Appropriate Applications	11–66
Table 12.1	Prohibited Lead-Based Paint Abatement Methods.	12–13
Table 12.2	Comparison of Lead-Based Paint Abatement, Removal and Enclosure.	12–17
Table 12.3	Steps To Install Drywall and Fiberboard on Interior Walls.	12–27
Table 13.1	Advantages and Disadvantages of Using Encapsulants.	13–7
Table 13.2	Categories of Encapsulants.....	13–10
Table 13.3	Steps for Obtaining Proper Application and Installation of an Encapsulant System.....	13–22
Table 14.1	Summary Guidance on Cleaning Methods by Dustiness of Work and Condition of the Surface.....	14–18



Table 15.1	Recommended Minimum Number and Location of Dust Samples.	15–27
Table 15.2	Clearance Dust Standards (Single-Surface Wipe Samples).....	15–39
Table 15.3	Clearance Dust Standards (Composite Wipe Samples).	15–41
Table 15.4	Hypothetical Example of Single-Surface Clearance Dust Sampling Data.	15–41
Table 15.5	Hypothetical Example of Composite Clearance Dust Sampling Data.	15–41
Table 16.1	Summary of Recommendations for Assessment and Remediation of Residential Lead Exposure	16–10
Table 16.2	Guidelines for Questions to Ask Regarding a Child’s Environmental History.....	16–12
Table 16.3	Common Sources of Lead Exposure to Consider in an Environmental Investigation.....	16–13
Table 16.4	Published Reports of Less Common Causes of Elevated Blood Lead levels (EBLs) in Children.....	16–16

Chapter 1: Introduction

I. Legislative Basis and Relationship to Federal Programs and Regulations	1-3
A. Legislative Basis	1-3
B. Intended Audience	1-3
II. Background on Childhood Lead Poisoning, Sources of Lead in the Environment, and the Evolution of Lead Poisoning Prevention	1-4
A. Childhood Lead Poisoning	1-4
1. Health Hazards.....	1-4
2. Prevalence Rates.....	1-5
3. Highest Risk Populations	1-5
4. Health Screening	1-5
5. Updated CDC Recommendations	1-6
B. Causes of Childhood Lead Poisoning.....	1-6
1. Lead in Residential Paint.....	1-6
2. Lead-Based Paint in Housing.....	1-6
3. Lead in Surface Dust.....	1-7
4. Lead in Soil	1-7
5. Other Causes of Lead Poisoning	1-8
C. The Evolution of Prevention Approaches	1-8
1. Medical Treatment of Poisoned Children (Tertiary Treatment).....	1-8
2. Screening and Case Management Programs (Secondary Prevention).....	1-8
3. Primary Prevention.....	1-9
III. The Title X Regulatory Framework.....	1-9
A. Definition of "Lead-Based Paint Hazard"	1-9
B. Regulatory Framework for Lead Hazard Control	1-10
1. Evaluating Lead Hazards.....	1-11
2. Controlling Lead Hazards	1-12
C. Requirements To Ensure Quality Control.....	1-13
1. Training and Certification	1-13
2. Accreditation of Training Providers	1-13
3. Health-Based Standards	1-13
4. Performance Standards for Testing and Abatement Products.....	1-13
5. Laboratory Accreditation.....	1-14
D. State and Local Regulations.....	1-14
IV. Organization and Use of the Guidelines	1-14
A. Chapter Organization.....	1-14
1. Chapters 1-4: Background Information	1-14
2. Chapters 5-7: Hazard Evaluation and Ongoing Maintenance.....	1-15
3. Chapters 8-10: Preparation for the Project	1-15



4. Chapters 11-15: Hazard Control, Cleanup, and Clearance	1-15
5. Chapters 16-18: Related Issues	1-16
6. Glossary and Appendices	1-16
B. Units of Measurement	1-16
C. Federal Lead Standards	1-17
REFERENCES	1-18
FIGURES	
Figure 1.1 Some paints contained 50% lead and were aggressively marketed.....	1-6
Figure 1.2 Deteriorated residential paint on house trim.....	1-7
Figure 1.3 Paint deterioration.	1-7
Figure 1.4 Title X's Lead Hazard Control Framework	1-11

Chapter 1: Introduction

I. Legislative Basis and Relationship to Federal Programs and Regulations

A. Legislative Basis

The *Guidelines* are issued pursuant to Section 1017 of the Residential Lead-Based Paint Hazard Reduction Act of 1992, which is often referred to as Title X ("Title Ten") because it was enacted as Title X of the Housing and Community Development Act of 1992 (Public Law 102-550). The *Guidelines* are based on the concepts, definitions, and requirements set forth in Title X. Section III of this chapter describes the framework of concepts and definitions in Title X and the regulations issued pursuant to it.

As required by Section 1017, the *Guidelines* must be used for "federally supported work," which is defined in the Act as "any lead hazard evaluation or reduction activities conducted in federally owned or assisted housing or funded in whole or in part through any financial assistance program" of the Department of Housing and Urban Development, the Department of Agriculture or the Department of Veterans Affairs. The Act defines "federally owned housing" as "residential dwellings owned or managed by a Federal agency, or for which a Federal agency is a trustee or conservator." In this context, the term "Federal agency" includes HUD, the Department of Agriculture's Rural Development – Housing and Community Facilities Programs, the Savings Association Insurance Fund, the General Services Administration, the Department of Defense, the Department of Veterans Affairs, the Department of the Interior, and the Department of Transportation. The term "federally assisted housing" is defined in the Act as "residential dwellings receiving *project-based* assistance under programs including:

"(A) section 221(d)(3) or 236 of the National Housing Act;

"(B) section 1 of the Housing and Urban Development Act of 1965;

"(C) section 8 of the United States Housing Act of 1937; or

"(D) sections 502(a), 504, 514, 515, 516 and 533 of the Housing Act of 1949."

B. Intended Audience

These *Guidelines* were developed and have been revised to provide technical guidance to the many individuals and groups involved with, or affected by, lead-based paint in residential housing units, and, to the extent appropriate, child-occupied facilities (see Appendix 6) including:

- ◆ Lead-based paint abatement contractors and abatement supervisors.
- ◆ Residential renovation contractors.
- ◆ Residential painters and painting contractors.
- ◆ Building maintenance personnel.
- ◆ Lead-based paint risk assessors, paint inspectors and sampling technicians.
- ◆ Lead-based paint training providers.
- ◆ Contractor certifying or licensing agencies.

- ◆ Residential building owners and managers, including: public housing agencies and Tribally-Designated Housing Entities (TDHEs); private, nonprofit housing development organizations; and private, for-profit landlords, managers, and building owners.
- ◆ Federal agency staff, such as from HUD, EPA, CDC, USDA, GSA, DoD, VA, DOI, DOT, and other agencies that own or manage residential properties and/or child-occupied facilities.
- ◆ State and local housing and community development agencies.
- ◆ State and local health agencies.
- ◆ Architects and designers.
- ◆ Environmental laboratory personnel.
- ◆ Environmental laboratory accreditation organizations.
- ◆ Real estate agents and brokers.
- ◆ Property and casualty insurers.
- ◆ Lenders and appraisers.

These *Guidelines* are intended for use by trained and certified lead-based paint professionals. Under HUD and EPA regulations, contractors and individuals must be trained and/or certified to conduct inspections, risk assessments, lead-based paint hazard reduction activities, and clearance examinations. Firms performing renovations that disturb lead-based paint (including interim controls) must be certified in Renovation, Remodeling and Repair, and have an adequate number of Certified Renovators on each job to perform the job safely. Federal agencies have developed different resources for non-professionals, such as the “Lead Paint Safety Field Guide.” Various outreach and education documents are posted at: <http://www.epa.gov/lead/pubs/leadpbed.htm>, or may be requested by calling the National Lead Information Center at 1-800-424-LEAD (toll-free). Hearing- or speech-challenged individuals may access this number through TTY by calling the toll-free Federal Relay Service at 800-877-8339.

II. Background on Childhood Lead Poisoning, Sources of Lead in the Environment, and the Evolution of Lead Poisoning Prevention

As understanding of lead’s adverse health effects and the sources and pathways of exposure to children has improved, so has recognition of the seriousness of lead-based paint hazards.

A. Childhood Lead Poisoning

Despite steady and impressive progress in reducing blood-lead levels (BLLs) among the U.S. population, childhood lead poisoning remains a major preventable environmental health problem in the United States.

1. Health Hazards

Lead is highly toxic and affects virtually every system of the body. At high exposure levels, lead poisoning can cause convulsions, coma, and death. While adults can also suffer from excessive

lead exposures (discussed in Chapter 9), the groups most at risk are fetuses, infants, and children under age 6. At low levels, lead's neurotoxic effects have the greatest impact on children's developing brains and nervous systems, causing reductions in IQ and attention span, reading and learning disabilities, hyperactivity, and behavioral problems (Davis, 1993). These effects have been identified in many carefully conducted research studies (see the literature review in National Academy of Sciences, 1993). However, the vast majority of childhood lead poisoning cases go undiagnosed and untreated, because most poisoned children have no obvious symptoms.

2. Prevalence Rates

In October 1991, CDC formally revised its statement on *Preventing Lead Poisoning in Young Children* (CDC, 1991a), reducing its "level of concern" for childhood lead poisoning from the previous threshold of 25 micrograms/deciliter ($\mu\text{g}/\text{dL}$) to 10 $\mu\text{g}/\text{dL}$. (See section IV.B, below for a description of units of measurement for lead in blood, paint, dust, soil, air, and water.) This change was based on scientific evidence indicating that adverse health effects can occur at levels as low as 10 $\mu\text{g}/\text{dL}$. In August 2005, CDC estimated that 310,000, or 0.7%, of American children under age 6 have BLLs above 10 $\mu\text{g}/\text{dL}$ (CDC, 2005). More recent research suggests that such effects occur at levels well below 10 $\mu\text{g}/\text{dL}$ (see, e.g., the literature review in CDC ACCLPP, 2012). No blood lead threshold for adverse health effects has been identified in children.

3. Highest Risk Populations

Lead poisoning affects children across all socioeconomic strata and in all regions of the country. However, because lead-based paint hazards are most severe in older, dilapidated housing, the poor in inner cities are disproportionately affected. In many such neighborhoods over half of all young children have lead poisoning. The National Health and Nutrition Examination Survey (NHANES) reported that, in 1999-2002, non-Hispanic blacks and Mexican Americans had higher percentages of elevated BLLs than non-Hispanic whites (Schwemberger, 2005). Although the disparity in risk for BLLs greater than or equal to 10 $\mu\text{g}/\text{dL}$ by income and race are no longer statistically significant; disparities by race/ethnicity and income still persist at lower blood lead levels (Jones, 2009).

4. Health Screening

In 1990, CDC called for a phase-in of universal blood-lead testing of all young children (unless it can be shown that the community has no lead poisoning problem) because most poisoned children do not exhibit easily identifiable symptoms and virtually all children are at risk (CDC, 1991b). The Medicaid Guidelines called for all children under age 6 to be tested (CMS, 1998). In 1993, the American Academy of Pediatrics (AAP) also revised its policy to recommend the routine screening of virtually all young children under age 6 (AAP, 1993). Because lead risk varies considerably by geography, CDC in 1997 recommended that State and local health departments assess local data on lead risks and develop lead-screening recommendations for health care providers in their jurisdictions, focusing on 1- and 2-year old children (CDC, 1997). CDC updated its statement in 2005 (see the Executive Summary in Appendix 16), while the U.S. Preventive Services Task Force (convened by the CDC) found that screening in asymptomatic children has not been demonstrated to be effective in improving clinical outcomes (Risshitelli, 2006).

5. Updated CDC Recommendations

CDC recommends that sources of lead in children’s environments be controlled or eliminated before children are poisoned, i.e. “primary prevention” (CDC, 2007; CDC, 2012a). CDC “emphasize[s] the importance of environmental assessments to identify and mitigate lead hazards before children demonstrate BLLs at or higher than the reference value” and has “adopt[ed] prevention strategies to reduce environmental lead exposures in soil, dust, paint, and water before children are exposed” through action by itself and others. Various counseling, monitoring, and community-wide prevention activities are recommended at various BLLs. Given that no safe blood lead level threshold in children has been identified, in 2012 CDC eliminated the use of a “blood lead level of concern” and redoubled its primary prevention efforts that remove lead before children are exposed. (CDC, 2012a) For further information, see Chapter 16.

B. Causes of Childhood Lead Poisoning

Today, children in the United States are lead poisoned primarily through ingestion of lead-containing dust by normal hand-to-mouth and toy-to-mouth activity. Because lead is ubiquitous in industrial societies, there are many sources and pathways of lead exposure.

1. Lead in Residential Paint

The foremost cause of childhood lead poisoning in the United States today is lead-based paint and the accompanying contaminated dust and soil found in older houses (CDC, 1991b; Rabinowitz, 1985b; Jacobs, 1994). As early as 1897, lead-based paint was identified as a cause of childhood lead poisoning (Turner, 1897; Reich, 1992; Markowitz, 2000; Warren, 2002; Bellinger, 2006). Many countries prohibited the use of lead in residential paints as far back as 1922 (Rabin, 1989). Lead was a major ingredient in most interior and exterior oil house paints before 1950, with some paints containing as much as 50 percent lead by dry weight (see *Figure 1.1*). In the early 1950s, other ingredients became more popular, but some lead pigments, corrosion inhibitors, and drying agents were still used. Lead was first regulated in residential paint in 1972 at 0.5 percent and “banned” in 1978, meaning that paint could contain no more than 0.06 percent (600 parts per million) lead by dry weight (Rabin, 1989; Reich, 1992). The Consumer Product Safety Improvement Act of 2008 (Public Law 110-314) reduced the threshold to 0.009 percent (90 parts per million) lead by dry weight (CPSC, 2008).

2. Lead-Based Paint in Housing

HUD estimates that 38 million housing units have lead-based paint (Jacobs, 2002). The likelihood, extent, and concentration of lead-based paint increase with the age of the building.



FIGURE 1.1 Some paints contained 50% lead and were aggressively marketed.



FIGURE 1.2 Deteriorated residential paint on house trim.



FIGURE 1.3 Paint deterioration.

Because the greatest risk of paint deterioration is in dwellings built before 1950, older housing generally commands a higher priority for lead hazard controls (see Figures 1.2 and 1.3). (See Chapter 5 for lead-based paint prevalence data by building component type and prevalence of housing with significant lead-based paint hazards by year of construction.)

3. Lead in Surface Dust

The belief that in order to be poisoned children must eat lead-based paint chips is unfounded. The most common cause of poisoning is the ingestion – through hand-to-mouth transmission – of lead-contaminated

surface dust (Clark, 1991; Bellinger, 1991; Roberts, 1991; Chisolm, 1985; Farfel and Chisolm, 1990; Farfel, 1994a; Lanphear, 1998). HUD estimates that 15.5 million housing units have levels of lead in interior dust that exceed EPA standards (Jacobs, 2002). Lead-contaminated dust may be so fine that it cannot be seen by the naked eye. In addition, lead-contaminated dust is difficult to clean up. Leaded-dust is generated as lead-based paint deteriorates over time, is damaged by moisture, abraded on friction and impact surfaces, or disturbed in the course of renovation, repair, or abatement projects. Lead can also be tracked into homes from exterior dust and soil. Since Congress also defined lead found in dust and soil to be lead-based paint hazards, these *Guidelines* address lead in surface dust and soil as well as in paint.

4. Lead in Soil

Children can also be exposed to lead in bare soil. HUD estimates that almost 5 million housing units have levels of lead in soil that exceed EPA standards (Jacobs, 2002). The high levels of lead in soil typically come from deteriorating exterior lead-based paint around the foundation of a house (Ter Harr, 1974; Linton, 1980). The fallout of lead emissions from the combustion of leaded-automobile gasoline, lead-based paint, and industrial sources also contributes to lead levels in soil (ATSDR, 1988). In some areas high leaded-soil levels result from factory and smelter emissions or deteriorating lead-based paint on steel structures, such as bridges. Bare soil that is contaminated with lead poses a hazard to children who play in it. Lead in soil may also be tracked into a home, increasing interior levels of dust lead. These *Guidelines* address lead-contaminated soil, as well as lead-based paint and lead-contaminated dust.

5. Other Causes of Lead Poisoning

Other sources and pathways of lead poisoning in children can include drinking water, point sources (such as smelters or industrial dischargers), ceramics, toys, children's jewelry, lead brought home from a parent's workplace, imported candy and its candy wrappers, home and folk remedies, cosmetics, and hobbies (such as casting lead sinkers or toy soldiers, making stained glass, loading ammunition, and soldering). These sources may account for some children's exposure; however, for most children, paint, dust, and soil are the primary sources of lead poisoning. For additional and more recent information, go to CPSC home page, <http://www.cpsc.gov/>, look on that home page for recent news and click on "CPSC Publications." You may then click on "Find Publications by Specific Topic" to search for Lead and/or for Lead-based paint. If you click on the Spanish header to the CPSC Publications page, you may search for "plomo" in "Publicaciones en Español." You may also visit the CDC Lead Poisoning Prevention Program home page: <http://www.cdc.gov/nceh/lead/>.

C. The Evolution of Prevention Approaches

The approach to identifying and responding to lead-based paint hazards and how they poison children in American housing has evolved over the past several decades.

1. Medical Treatment of Poisoned Children (Tertiary Treatment)

During the 1940s and 1950s, deaths from childhood lead poisoning were common. Using chelation therapy (the use of drugs to excrete lead from the body), medical providers attempted to treat symptomatic cases to prevent death, with the assumption that children who survived had been cured. During the 1950s, studies in Chicago (Williams, 1952), New York City (McLaughlin, 1956), and Baltimore (Chisolm, 1956) demonstrated conclusively that children who survived serious lead poisoning were often left mentally retarded or otherwise permanently impaired (Lin-Fu, 1982). More recent chelating agents are D-penicillamine and succimer (WebMD, 2010 at <http://emedicine.medscape.com/article/815399-treatment>). Chelation therapy should only be undertaken in consultation with a medical doctor with experience in the chelation of children for lead poisoning.

2. Screening and Case Management Programs (Secondary Prevention)

Recognition of these neurological problems gave rise to expanded screening and case management programs in many cities and states. Before the late 1980's, the traditional approach to childhood lead poisoning prevention was reactive, relying on the identification of a poisoned child to trigger investigation of lead hazards in the home environment. Based on the belief that children had to eat lead-based paint chips to be poisoned, the typical response to a lead poisoning during the 1970s and early 1980s consisted of removing deteriorated lead-based paint by scraping, uncontrolled sanding, or open flame burning. Approaches differed slightly, depending on the jurisdiction. Some jurisdictions required removal of all lead-based paint below a certain height, such as 5 feet; others required only that deteriorating paint be removed. However, these traditional abatements had one common characteristic: little attention was paid to controlling, containing, and cleaning up leaded-dust. In many cases these paint removal methods actually aggravated the problem and increased lead exposures,

poisoning workers and children in the process. Several studies found that uncontrolled abatement and inadequate cleanup caused increased blood-lead levels (Farfel and Chisolm, 1990; Rabinowitz, 1985a; Amitai, 1987).

3. Primary Prevention

As knowledge about lead poisoning increased, Congress concluded that responding to poisoned children was an ineffective solution to the nationwide problem. Legislation reflected a shift toward primary prevention. During the 1980s, HUD's requirements regarding treatment of lead-based paint were similarly amended. Department-wide regulatory revisions pertaining to lead-based paint in certain programs were made in 1986, 1987 and 1988. Housing and community development regulations began to include primary prevention strategies such as requiring inspections of pre-1978 public housing and abatement during substantial rehabilitation. HUD's 1990 *Interim Guidelines for Hazard Identification and Abatement in Public and Indian Housing (Interim Guidelines)*, which evolved from the 1987 Housing and Community Development Act, emphasized the danger of lead-contaminated dust and the need for worker protection and thorough cleanup. HUD's Office of Public and Indian Housing revised its program provisions in 1991, and made important changes in 1995 to the Housing Quality Standards (HQS), which apply to Section 8 tenant-based rental assistance and certain other HUD programs. When Title X was signed in 1992, primary prevention was included in the national strategy. The first edition of the final *Guidelines* was issued in 1995 and, as a documented methodology, has been incorporated by reference into many states' lead laws. The data demonstrating that no "safe" threshold for blood lead levels in young children has been identified highlights the importance of preventing childhood exposures to lead. It confirms the need for a systematic and society-wide effort to control or eliminate lead hazards in children's environments before they are exposed. In 2005, CDC specifically focused on primary prevention and published *Preventing Lead Poisoning in Young Children* (CDC, 2005).

III. The Title X Regulatory Framework

Title X fundamentally reorganized the national approach to controlling lead-based paint hazards in housing by focusing attention on lead hazards through the establishment of new requirements for property owners as well as Federal agencies and mandating action to improve the safety and effectiveness of lead-based paint activities.

A. Definition of "Lead-Based Paint Hazard"

Title X redefined the concept of "lead-based paint hazards." Under earlier Federal legislation (Housing and Community Development Act of 1987; Public Law 100-242), a lead-based paint hazard was defined as any paint containing 1 mg/cm² or more of lead regardless of its condition or location. Title X states that a lead-based paint hazard is "any condition that causes exposure to lead from lead-contaminated dust, lead-contaminated soil, or lead-contaminated paint that is deteriorated or present in accessible surfaces, friction surfaces, or impact surfaces that would result in adverse human health effects..." (emphasis added, 42 U.S.C. 4851b(15)). Thus, under this definition, intact lead-based paint on most walls and ceilings is not considered a "hazard," although the condition of the paint should be monitored and maintained to ensure that it does not deteriorate. While most efforts to reduce lead hazards in housing will now be aimed at controlling lead-based paint hazards as defined by Title X,

Federal law makes one notable exception: in public housing and Tribally-Designated Housing Entities, all lead-based paint must be abated when the housing is modernized.

B. Regulatory Framework for Lead Hazard Control

As directed by the Congress in Title X, HUD, EPA, OSHA, and CDC have issued the following regulations and guidelines with respect to the evaluation and control of lead-based paint hazards in housing (Refer to Appendix 6):

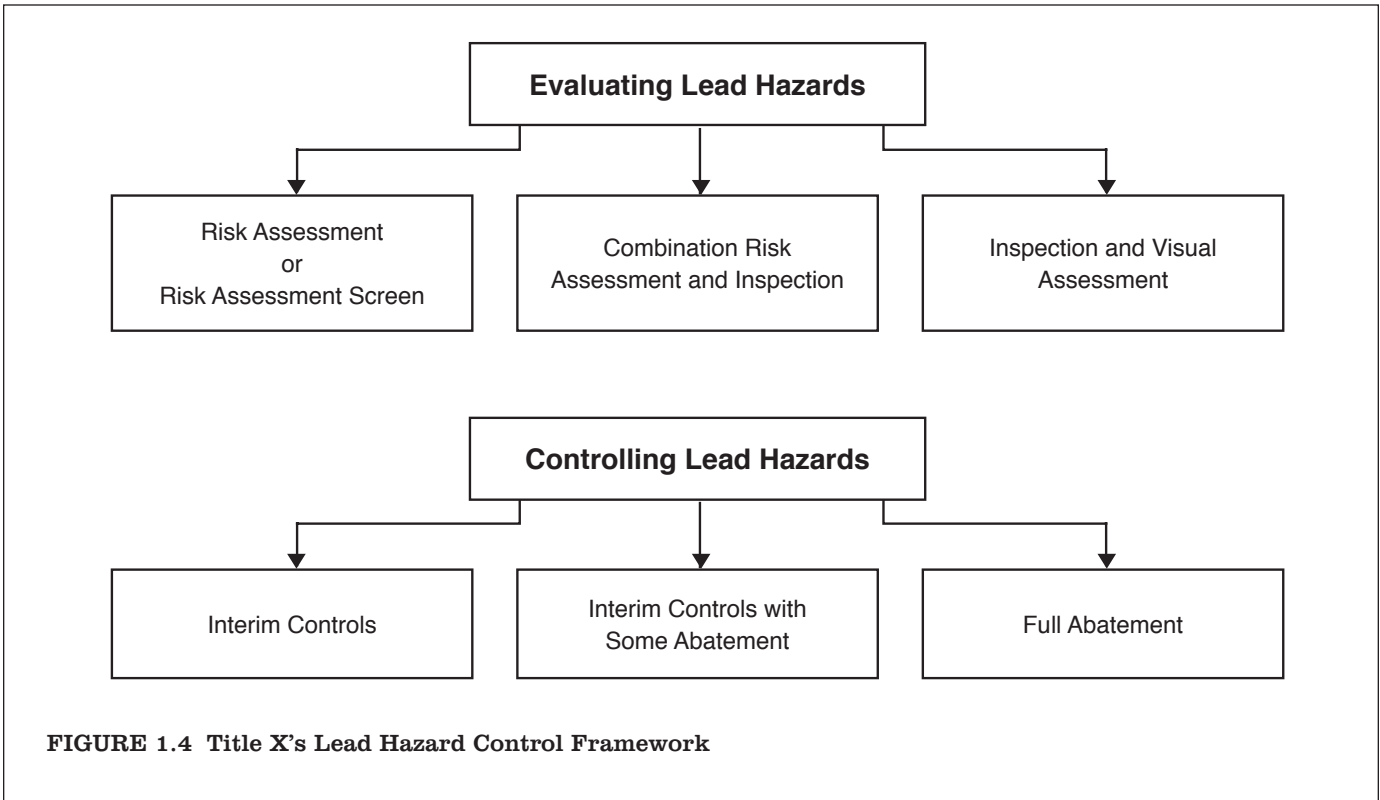
- ◆ HUD and EPA jointly: Requirements for Disclosure of Known Lead-Based Paint and/or Lead-Based Paint Hazards Upon Sale or Lease of Residential Property (HUD: 24 CFR Part 35, subpart A; EPA: 40 CFR Part 745, subpart F).
- ◆ HUD: Requirements for Notification, Evaluation and Reduction of Lead-Based Paint Hazards in Federally Owned Residential Property and Housing Receiving Federal Assistance, known as the HUD Lead Safe Housing Rule (24 CFR Part 35, subparts B-R).
- ◆ EPA: Requirements for Lead-Based Paint Activities in Target Housing and Child Occupied Facilities; Requirements for Hazard Education Before Renovation of Target Housing; Identification of Dangerous Levels of Lead; Renovation, Repair, and Painting. (40 CFR Part 745).
- ◆ OSHA: Interim Lead in Construction Standard (29 CFR 1926.62).
- ◆ CDC: CDC Response to Advisory Committee on Childhood Lead Poisoning Prevention Recommendations in "Low Level Lead Exposure Harms Children: A Renewed Call of Primary Prevention." (CDC, 2012a). Preventing Lead Poisoning in Young Children (CDC, 2005); Managing Elevated Blood Lead Levels Among Young Children (CDC, 2002); and Screening Young Children for Lead poisoning: Guidance for State and Local Public Health Officials (CDC, 1997).

These regulations and guidelines constitute the Federal regulatory framework for the evaluation and control of lead-based paint hazards in housing, as of the publication of this second edition of the *Guidelines*. Future regulations, including revisions of existing regulations, are possible; the agencies' websites should be checked for regulatory updates.

There are three Federal government initiatives that may affect the way lead-based paint issues are defined and dealt with in the future. In January 2012, an advisory committee to the CDC recommended that CDC no longer use the term "level of concern", but use a childhood blood lead level reference value of 5 µg/dL, with possible future reductions (CDC ACCLPP, 2012); CDC considered the committee's recommendations in formulating its policies, which it published on May 16, 2012 (CDC, 2012a). CDC adopted the core recommendation of eliminating the term "level of concern" from its future policies, guidance documents, and other CDC publications, and it will use a childhood blood lead level (BLL) reference value based on the 97.5th percentile of the population BLL in children ages 1-5 (5 µg/dL as of the publication of this edition of these *Guidelines*) to identify children and environments associated with lead-exposure hazards. CDC also adopted the recommendation that the reference value should be updated by CDC every four years based on the most recent population based blood lead surveys among children. CDC's response to the other recommendations is provided in their full response. At the same time, CDC also issued Fact Sheet: Blood Lead Levels in Children – Important Information for Parents, providing parents and other concerned individuals with an update on this issue (CDC, 2012b). documents.

1. Evaluating Lead Hazards

The principal lead hazard evaluation methods are 1) risk assessment or lead hazard screen, 2) risk assessment combined with lead-based paint inspection, and 3) lead-based paint inspection combined with visual assessment (see *Figure 1.4*). Alternatives to evaluation include visual assessment and the presumption that lead-based paint and/or lead-based paint hazards are present.



“Risk assessment” is an onsite investigation of a residential building for lead-based paint hazards and includes, but may not be limited to: a visual inspection; targeted environmental sampling of dust, soil, and deteriorated paint; and a report of the results that identifies acceptable abatement and interim control strategies for controlling any identified lead-based paint hazards. Risk assessments and paint inspections can be combined to provide a more comprehensive evaluation of lead hazards (see Chapters 3, 5 and 7).

“Lead hazard screen” is a limited assessment of hazards performed in accordance with the methods and standards made by the state or EPA, as appropriate. A lead hazard screen may identify the need for a follow-up risk assessment.

“Paint inspection” is a surface-by-surface investigation of all painted surfaces – interior and exterior – in common areas of multi-family buildings, as well as in dwelling units. The inspection uses portable X-ray fluorescent (XRF) analyzers and/or laboratory analysis of paint samples to determine the presence of lead-based paint, and provides a report of the results. Inspections to identify the presence of lead-based paint should not be confused with clearance examinations, risk assessments, or investigations of homes with lead-poisoned children. Adding a visual assessment will identify the presence of deteriorated paint that is a hazard.

“Visual Assessment” alone is an alternative to evaluation. Under some circumstances, such as for dwelling units occupied by families with tenant-based rental assistance or as part of ongoing lead-based paint maintenance, property owners or housing quality inspectors may conduct a visual assessment to identify any deteriorated paint, unusual amounts of visible dust, or other conditions that suggest the possible existence of lead hazards. HUD does not consider a visual assessment by itself to constitute an “evaluation” because it does not include a scientific test for the presence of lead. Nevertheless, a visual assessment that is combined with a lead-based paint inspection can identify the presence of lead-based paint hazards.

“Presumption” is another alternative to evaluation. Property owners may presume that all painted surfaces are coated with lead-based paint and that all bare soil is hazardous, so long as they treat all surfaces to be disturbed as if they contain lead. Such a presumptive approach may be cost-effective in the case of pre-1960 housing in poor condition. Presumption is specifically included in the Lead Safe Housing Rule.

2. Controlling Lead Hazards

Title X provides for three types of lead hazard control: interim controls; abatement of lead-based paint hazards; and complete abatement of all lead-based paint (see Figure 1.4). Interim control and abatement activities are frequently combined in lead hazard control projects. Other construction activities, such as renovation and remodeling, rehabilitation, and weatherization, also may treat some or all lead hazards. These *Guidelines* recommend procedures that increase the safety and effectiveness of all types of construction projects that are carried out in housing that might contain lead-based paint, regardless of the intent.

The three types of lead hazard control are described as follows:

Interim controls, according to Title X, are “a set of measures designed to reduce temporarily human exposure or likely exposure to lead-based paint hazards, including specialized cleaning, repairs, maintenance, painting, temporary containment, ongoing monitoring of lead-based paint hazards or potential hazards, and the establishment and operation of management and resident education programs.” Interim controls include cleaning surfaces of dust, paint film stabilization and friction and impact surface treatments. Interim controls are appropriate for implementation on a broad scale. Research has found them to be cost-effective in many cases (NCHH, 2004). Whenever interim controls are employed, the property owner should undertake ongoing maintenance of lead-based paint, as some potential hazards may still be present and new hazards may be created. Interim controls are essentially renovation and repair items, and fall under the EPA’s RRP rule.

Abatement of lead-based paint hazards, according to Title X, is “a set of measures designed to permanently eliminate lead-based paint hazards....” Such measures include: “(A) the removal of lead-based paint and lead-contaminated dust, the permanent containment or encapsulation of lead-based paint, the replacement of lead painted surfaces or fixtures, and the removal or covering of lead-contaminated soil; and (B) all preparation, cleanup, disposal, and post-abatement clearance testing activities associated with such measures.” Title X redefined the term “abatement” to mean the elimination of “lead-based paint hazards” to last for a period of twenty years, not necessarily removal of all lead-based paint.

Full abatement of lead-based paint is where all lead-based paint has been abated and clearance has been achieved. When paint removal is the abatement method used, the property has achieved the status of “lead-based paint free.” This can exempt the property from the Lead Safe Housing Rule, although disclosure of knowledge is still necessary for sale of target housing. If hazards are abated by encapsulation or enclosure, lead-based paint on the property would remain, and the property would not be “lead-based paint free.”

C. Requirements To Ensure Quality Control

To ensure that lead hazard control work is carried out safely and effectively, Title X imposed a number of requirements for consistency and quality control.

1. Training and Certification

EPA requires that all risk assessors, lead-based paint inspectors, dust sampling technicians, abatement supervisors, abatement workers, and renovation supervisors (“certified renovators”), who receive compensation for their work in target housing or pre-1978 child-occupied facilities that is not exempt from the applicable regulations, meet minimum training requirements and be certified by EPA or by an EPA-authorized State or Tribal program (40 CFR §§ 745.227 or 745.324). Workers on federally assisted abatement, interim control, maintenance or rehabilitation projects in target housing must meet HUD-approved training requirements (24 CFR §§ 35.1325 or 35.1330); since the EPA’s Renovation, Repair, and Painting (RRP) Rule went into effect in 2010, HUD’s lead-safe work practices training requirement is satisfied by EPA’s renovation certification training requirement. Technicians who collect dust samples in connection with clearance examinations (sampling technicians) after renovation and rehabilitation (but not abatement) must meet EPA and, if applicable, HUD training requirements (40 CFR 745.90 and 24 CFR 35.1340). Training is generally not provided by EPA or HUD, but is provided by the private sector and some state, local, and tribal governments.

2. Accreditation of Training Providers

EPA requires that every training program delivering courses for lead certification for activities in target housing and pre-1978 child-occupied facilities be accredited by either EPA or an EPA-authorized State or Tribal certification program.

3. Health-Based Standards

EPA has identified standards for dangerous levels of lead in household dust, soil, and paint, as set forth in section IV.C of this chapter, for use in risk assessments and for clearance after completion of lead hazard control activities.

4. Performance Standards for Testing and Abatement Products

HUD and EPA have established criteria, testing protocols, and performance standards checklists for lead-based paint evaluation and hazard reduction products. The American Society for Testing and Materials has also developed a number of such standards. Those criteria, protocols, performance characteristics and standards are reflected in these *Guidelines*.

5. Laboratory Accreditation

Laboratories analyzing environmental samples of lead in paint film, dust, and soil must be recognized by EPA under the National Lead Laboratory Accreditation Program (NLLAP). A state-by-state list of NLLAP-recognized laboratories is provided on the Internet at <http://www.epa.gov/lead/pubs/nllaplist.pdf>.

D. State and Local Regulations

Many States and some local governments have issued regulations governing lead hazard evaluation and control. If there is a difference between Federal, State and local regulations, the more stringent applicable requirements must be observed in any given jurisdiction.

IV. Organization and Use of the Guidelines

Evaluation and control of lead-based paint hazards is an evolving field. For cases in which research has demonstrated that certain techniques are appropriate, references are cited. In some cases, laws or regulations specify how something is to be done; in other cases, no or an insufficient amount of research has been done to describe clearly the best approach to solving a specific problem. Recognizing that problems require answers, these *Guidelines* offer advice based on the experience and considered judgment of the authors and reviewers, and on the applicable laws and regulations. For cases in which citations are not provided, the reader should assume that the source of the advice is anecdotal and is the best advice that HUD can provide at this time.

A. Chapter Organization

A short summary of steps is provided at the beginning of each technical chapter to alert the reader to especially critical points and action steps. In general, the material is presented in each chapter in order of sequence in a typical project; however, a complete reading and understanding of these *Guidelines* is essential before any project is undertaken. Wherever possible, the *Guidelines* explain the rationale for recommendations and provide a technical description of the action to be taken.

1. Chapters 1-4: Background Information

Understanding the background material is critical to the successful completion of any project.

Chapter 1, *Introduction*, describes the purpose and application of the *Guidelines*; briefly reviews the hazards of lead-based paint in housing; summarizes major departures from past approaches; and provides context in terms of Federal law, regulations, and agency programs.

Chapter 2, *Where To Go for Help-Qualifications and Roles*, introduces the types of individuals involved in evaluating and controlling lead-based paint hazards in housing, explains their roles, and summarizes their qualifications.

Chapter 3, *Before You Begin the Project-Planning to Control Lead Hazards*, identifies the critical issues that must be examined to avoid problems and mistakes that can result in project delays and cost overruns.

Chapter 4, *Lead-Based Paint and Housing Renovation*, provides general advice on how to carry out work in older housing so that lead hazards are not inadvertently created (e.g., by disturbing lead-based paint) and how to combine renovation with abatement work.

2. Chapters 5-7: Hazard Evaluation and Ongoing Maintenance

Hazard evaluation helps ensure the selection of the safest and most cost-effective hazard control strategy for each situation.

Chapter 5, *Risk Assessment and Reevaluation*, provides detailed guidance on how risk assessments are to be conducted in various categories of housing, including protocols for environmental sample collection and interpretation, evaluation of building and paint condition, and methods for sampling a subset of units in multi-family buildings.

Chapter 6, *Ongoing Lead-Safe Maintenance*, provides detail on how to properly manage remaining lead-based painted components and soil with elevated levels of lead into the future while minimizing risk. This chapter incorporates much of the contents of Chapter 17, *Routine Building Maintenance and Lead-Based Paint*, of the first edition of these *Guidelines*.

Chapter 7, *Lead-Based Paint Inspection*, provides detailed information on methods for testing housing to determine the presence of lead-based paint on a surface-by-surface basis, including the use of portable XRF analyzers and paint-chip sampling for laboratory analysis.

3. Chapters 8-10: Preparation for the Project

The critical steps in preparing to control lead-based paint hazards are covered in Chapters 8-10.

Chapter 8, *Resident Protection and Worksite Preparation*, provides guidance on the steps needed to ensure that occupants are not endangered and that contamination is not spread.

Chapter 9, *Worker Protection*, provides detailed advice on how to comply with the OSHA Lead in Construction Standard while performing work in housing.

Chapter 10, *Housing Waste*, provides practical advice on methods for handling and disposing various kinds of debris to protect the environment.

4. Chapters 11-15: Hazard Control, Cleanup, and Clearance

Detailed information on how to carry out all aspects of lead hazard control is provided in Chapters 11-15.

Chapter 11, *Interim Controls*, provides specific guidance on interim controls: general principles of interim controls; dust removal; paint film stabilization; friction surface treatments; and soil and exterior dust treatments. The chapter also incorporates some of the contents of Chapter 17 of the first edition of these *Guidelines*.

Chapter 12, *Abatement*, covers general principles of abatement such as component replacement, enclosure, paint removal methods, and soil abatement.

Chapter 13, *Encapsulation*, describes how to use encapsulants.

Chapter 14, *Cleaning Following Hazard Controls or other Paint-Disturbing Work*, details cleanup procedures for lead hazard control projects.

Chapter 15, *Clearance*, explains how to conduct clearance tests after a lead hazard control project to ensure that a unit or area is safe for reoccupancy.

5. Chapters 16-18: Related Issues

Information on addressing lead-based paint hazards in special situations is provided in the final chapters of these *Guidelines*.

Chapter 16, *Investigation and Treatment of Dwellings that House Children with Elevated Blood Lead Levels*, describes the special measures that are usually taken by health departments, property owners and others to investigate and treat environmental lead hazards once a child has been identified as having an elevated blood lead level.

The substance of **Chapter 17, *Routine Building Maintenance and Lead-Based Paint***, was incorporated into the revised Chapters 6 and 11. Chapter 17 is now reserved for potential future use.

Chapter 18, *Historic Preservation*, discusses the special situations and issues surrounding lead-based paint in historic dwellings.

6. Glossary and Appendices

The definitions of key terms are consolidated in the glossary and deserve special attention because the meanings of several key terms, such as “abatement” and “renovation,” differ from common usage. The appendices provide detailed background information and technical materials.

B. Units of Measurement

- ◆ **mg/cm²** – milligrams per square centimeter, used for paint.
- ◆ **mg/L** – milligrams per liter, used for water.
- ◆ **percent** – percent by weight, primarily used for paint (1 percent = 10,000 µg/g).
- ◆ **ppb** – parts per billion by weight (1,000 ppb = 1 ppm); primarily used for water.
- ◆ **ppm** – parts per million by weight (10,000 ppm = 1 percent), equivalent to µg/g; primarily used for paint and soil.
- ◆ **µg/dL** – micrograms per deciliter, used for blood.
- ◆ **µg/ft²** – micrograms per square foot, used for settled dust.
- ◆ **µg/g** – micrograms per gram of sample, equivalent to ppm by weight; primarily used for paint and soil.
- ◆ **µg/m³** – micrograms per cubic meter, used for air.

C. Federal Lead Standards

If Federal standards differ from State, Tribal or local standards, the most stringent (protective) standards must be applied.

- ◆ Lead-based paint – 24 CFR 35.110 and 40 CFR 745.103
1 mg/cm² or 5,000 µg/g (5,000 ppm, equal to 0.5 percent).
- ◆ Paint containing lead applied between 1978 and August 13, 2009
0.06 percent (600 ppm) by weight.
- ◆ Paint containing lead applied on or after August 14, 2009 – 16 CFR 1303.2
0.009 percent (90 ppm) by weight.
- ◆ Dust lead hazard levels (by wipe sampling) – 40 CFR 745.65(b)
40 µg/ft² – floors (carpeted and uncarpeted).
250 µg/ft² – interior windowsills.
- ◆ Dust lead levels for lead hazard screen only (by wipe sampling) – 24 CFR 35.1320(b)(2)(i)
25 µg/ft² – floors.
125 µg/ft² – interior windowsills.
- ◆ Dust lead clearance levels (by wipe sampling) – 40 CFR 745.227(e)(8)(viii)
40 µg/ft² – floors (includes carpeted and uncarpeted interior floors).
250 µg/ft² – interior windowsills.
400 µg/ft² – window troughs (previously called “window wells” in some literature).
- ◆ Bare residential soil hazard levels – 40 CFR 745.65(c)
400 µg/g – play areas used by young children.
1,200 µg/g – building perimeter (dripline or foundation area) and yard other than play areas.
- ◆ Airborne lead particulate – Occupational Exposure Criteria
30 µg/m³ – OSHA action level (8-hour time-weighted average) – 29 CFR 1926.62(b)
50 µg/m³ – OSHA permissible exposure limit (8-hour time-weighted average) – 29 CFR 1926.62(c)(1)
- ◆ National Primary and Secondary Ambient Air Quality Standard for Lead – 40 CFR 50.16(a)
0.15 µg/m³ – arithmetic mean concentration averaged over a 3-month period.
- ◆ Lead action level for drinking water systems – 40 CFR 141.80(c)(1)
15 ppb (0.015 mg/L) – Exceeded if lead is above this concentration in over 10% of a drinking water system’s tap water samples.

References

- AAP, 1993. American Academy of Pediatrics, Committee on Environmental Health. Lead Poisoning From Screening to Primary Prevention, Statement on Childhood Lead Poisoning, RE 9307.
- Amitai, 1987. Amitai, Y., J.W. Graef, M.J. Brown, R.S. Gerstle, N. Kahn, and P.E. Cochrane. "Hazards Of 'Deleading' Homes Of Children With Poisoning," *American Journal of Diseases of Children* 141: 758–760.
- ATSDR, 1988. Agency for Toxic Substances and Disease Registry, U.S. Department of Health and Human Services, *The Nature and Extent of Lead Poisoning in Children in the United States: A Report to Congress*, Atlanta, Georgia. <http://www.cdc.gov/mmwr/preview/mmwrhtml/00001077.htm>
- Bellinger, 1991. Bellinger D., J. Sloman, A. Leviton, M. Rabinowitz, H. Needleman, and C. Waternaux, "Low Level Lead Exposure and Children's Cognitive Function in the Preschool Years," *Pediatrics* 87: 219227.
- Bellinger, 2006. D. C. and A. M. Bellinger, "Childhood lead poisoning: The torturous path from science to policy, *Journal of Clinical Investigation*, 116: 853-857. doi: 10.117/JCI28232. <http://www.jci.org/articles/view/28232/pdf>
- CDC, 1991a. Centers for Disease Control, U.S. Department of Health and Human Services. *Preventing Lead Poisoning in Young Children: A Statement by the Centers for Disease Control*. 4th revision. Atlanta, Georgia. <http://wonder.cdc.gov/wonder/prevguid/p0000029/p0000029.asp>
- CDC, 1991b. Centers for Disease Control, U.S. Department of Health and Human Services. *Strategic Plan for the Elimination of Childhood Lead Poisoning*, Atlanta, Georgia. <http://wonder.cdc.gov/wonder/prevguid/p0000029/p0000029.asp>
- CDC, 1997. Centers for Disease Control and Prevention, U.S. Department of Health and Human Services. *Screening Young Children for Lead Poisoning: Guidance for State and Local Public Health Officials*, Atlanta, Georgia. <http://www.cdc.gov/nceh/lead/publications/screening.htm>
- CDC, 2000. Centers for Disease Control and Prevention, U.S. Department of Health and Human Services. Morbidity and Mortality Weekly Report. "Blood Lead Levels in Young Children-United States and Selected States, 1996-1999," December 22, 2000 / 49(50);1133-7. <http://www.cdc.gov/mmwr/preview/mmwrhtml/mm4950a3.htm>
- CDC, 2002. Centers for Disease Control and Prevention, U.S. Department of Health and Human Services. Managing Elevated Blood Lead Levels Among Young Children: Recommendations from the Advisory Committee on Childhood Lead Poisoning Prevention. March 2002. http://www.cdc.gov/nceh/lead/casemanagement/casemanage_main.htm
- CDC, 2005. Centers for Disease Control and Prevention, U.S. Department of Health and Human Services, *Preventing Lead Poisoning in Young Children*. 5th revision. Atlanta, Georgia. Available at <http://www.cdc.gov/nceh/lead/publications/prevleadpoisoning.pdf>
- CDC, 2007. Interpreting and Managing Blood Lead Levels < 10 µg/dL in Children and Reducing Childhood Exposures to Lead: Recommendations of the CDC's Advisory Committee on Lead Poisoning Prevention. MMWR. Recommendations and Reports November 2, 2007;56.

CDC ACCLPP, 2012. CDC Advisory Committee on Childhood Lead Poisoning Prevention. Low Level Lead Exposure Harms Children: A Renewed Call for Primary Prevention. Report of the Advisory Committee on Childhood Lead Poisoning Prevention of the Centers for Disease Control and Prevention. http://www.cdc.gov/nceh/lead/ACCLPP/Final_Document_030712.pdf

CDC, 2012a. *CDC Response to Advisory Committee on Childhood Lead Poisoning Prevention Recommendations in "Low Level Lead Exposure Harms Children: A Renewed Call of Primary Prevention."* June 7, 2012. http://www.cdc.gov/nceh/lead/ACCLPP/CDC_Response_Lead_Exposure_Recs.pdf.

CDC, 2012b. Fact Sheet: Blood Lead Levels in Children – Important Information for Parents. http://www.cdc.gov/nceh/lead/ACCLPP/Lead_Levels_in_Children_Fact_Sheet.pdf

Chisolm, 1956. Chisolm, J.J., and H.E. Harrison, "The Exposure of Children to Lead," *Pediatrics* 18: 943-958.

Chisolm, 1985. Chisolm, J.J., E.D. Mellits, and S.A. Quaskey, "The Relationship Between the Level of Lead Absorption in Children and the Age, Type, and Condition of Housing," *Environmental Research* 38: 31-45.

Clark, 1991. Clark, C.S., R. Bornschein, P. Succop, S. Roda, and B. Peace, "Urban Lead Exposures of Children in Cincinnati, Ohio," *Journal of Chemical Speciation and Bioavailability*, 3(3/4): 163-171.

CPSC, 2008. Consumer Product Safety Commission. "Ban of Lead-Containing Paint and Certain Consumer Products Bearing Lead-Containing Paint." 73 Federal Register 77492-77493; December 19, 2008. Download via <http://origin.www.gpoaccess.gov/fr/>.

CMS, 9/98. Department of Health and Human Services Health Care Financing Administration (now Centers for Medicare & Medicaid Services). "Early and Periodic Screening, Diagnosis, and Treatment (EPSDT): Lead Toxicity Screening." HCFA Pub. 45-5.

Davis, 1993. Davis, J.M., Elias, R.W., Grant, L.D., "Current Issues in Human Lead Exposure and Regulation of Lead," *Neurotoxicology* 14(2-3): 1528.

Farfel, 1994a. Farfel, M., Briefing at EPA headquarters, Washington, DC, February 1994.

Farfel and Chisolm, 1990. Farfel, M., and J.J. Chisolm, Jr., "Health and Environmental Outcomes of Traditional and Modified Practices for Abatement of Residential Lead-Based Paint," *American Journal of Public Health* 80: 10, 1240-1245.

HUD/EPA letter, 2001. Sanders, W.H., and D.E. Jacobs, public letter signed jointly by the U.S. Environmental Protection Agency and the U.S. Department of Housing and Urban Development to clarify Federal requirements for rehabilitation and lead hazard reduction in property receiving up to \$25,000 in Federal rehabilitation assistance, April 19, 2001. http://portal.hud.gov/hudportal/documents/huddoc?id=DOC_25480.pdf

Jacobs, 1994. Jacobs, D.E., *Lead-Based Paint Abatement at Murphy Homes*, Georgia Tech Research Institute report, unpublished.

Jacobs, 2002. Jacobs, D.E., R.P. Clickner, J.Y. Zhou, S.M. Viet, D.A. Marker, J.W. Rogers, D.C. Zeldin, P. Broene and W. Friedman, "The Prevalence of Lead-Based Paint Hazards in US Housing," *Environmental Health Perspectives*, 110(10): 599, October 2002. <http://ehp03.niehs.nih.gov/article/fetchArticle.action?articleURI=info%3Adoi%2F10.1289%2Fehp.021100599>

Jones, 2009. Jones R, Homa D, Meyer P, Brody D, Caldwell K Pirkle J, Brown MJ. Trends in blood lead levels and blood lead testing among U. S. children aged 1 to 5 years: 1998-2004. *Pediatrics* 2009;123:e376-e385

Lanphear, 1998. Lanphear B.P., T.D. Matte, J. Rogers, R.P. Clickner, B. Dietz, R.L. Bornschein, P. Succop, K.R. Mahaffey, S. Dixon, W. Galke, M. Rabinowitz, M. Farfel, C. Rohde, J. Schwartz, P. Ashley, D.E. Jacobs. "The Contribution of Lead-Contaminated House Dust and Residential Soil to Children's Blood Lead Levels: A Pooled Analysis of 12 Epidemiological Studies," *Environmental Research* 79: 5168.

Lin-Fu, 1982. Lin-Fu, J., "Children and Lead, New Findings and Concerns," *New England Journal of Medicine* 307: 615-617.

Linton, 1980. Linton, R.W., D.F.S. Natush, R.L. Solomon, C.A. Evans, "Physicochemical Characterization of Lead in Urban Dusts: A Microanalytical Technique to Lead Tracing," *Environmental Science Technology* 14: 159-164.

Markowitz, 2000. G. Markowitz and D. Rosner, "Cater to the Children: The role of the Lead Industry in a Public Health Tragedy, 1900-1955, *Am. J. Public Health*, 90: 36-46. <http://www.mindfully.org/Health/Lead-Industry-Public-Health.htm>

McLaughlin, 1956. McLaughlin, "Lead Poisoning in Children in New York City, 1940-1954," *New York State Medical Journal* 56: 3711-3714.

National Academy of Sciences, 1993. *Measuring Lead Exposure in Infants, Children, and Other Sensitive Populations*, Committee on Measuring Lead in Critical Populations, Board on Environmental Studies and Toxicology, Commission on Life Sciences, National Academy Press, Washington, DC.

NCHH, 2004. National Center for Healthy Housing, and University of Cincinnati Department of Environmental Health, *Evaluation of the HUD Lead-Based Paint Hazard Control Grant Program: Final Report*, prepared for the U.S. Department of Housing and Urban Development, Washington, DC, May 1, 2004.

New York Times, 1971. Bird, D., "High Lead Paints Listed by City," *New York Times*, August 4, 1971: 18.

Rabin, 1989. Rabin, R., "Warnings Unheeded: A History of Lead Poisoning," *American Journal of Public Health* 79: 1668-1674. <http://ajph.aphapublications.org/cgi/reprint/79/12/1668>

Rabinowitz, 1985a. Rabinowitz, M., A. Leviton, and D. Bellinger, "Home Refinishing, Lead Paint, and Infant Blood Lead Levels," *American Journal of Public Health* 75(4): 403-404. <http://ajph.aphapublications.org/cgi/reprint/75/4/403.pdf>

Rabinowitz, 1985b. Rabinowitz, M., A. Leviton, H. Needleman, D. Bellinger, and C. Waternaux, "Environmental Correlates of Infant Blood Lead Levels in Boston," *Environmental Research* 38: 96-107.

Reich, 1992. Reich, P., *The Hour of Lead*, Environmental Defense Fund, Washington, DC.

Roberts, 1991. Roberts, J.W., D.E. Camann, and T.M. Spittler, "Reducing Lead Exposure From Remodeling and Soil Track-In in Older Homes," in *Proceedings of the Annual Meeting of Air and Waste Management Association*, Paper No. 91-134.2, Vancouver, British Columbia, Canada.

Schwemberger, 2005. J.G. Schwemberger, J.E. Mosby, M.J. Doa. D.E. Jacobs, P.J. Ashley, D.J. Brody, M.J. Brown, R.L. Jones, D. Homa, *Blood Lead Levels - United States, 1999-2002*, MMWR Weekly, 54(20);513-516, Atlanta, Georgia. Available at <http://www.cdc.gov/mmwr/preview/mmwrhtml/mm5420a5.htm>

Ter Har, 1974. Ter Har, G., and R. Aronow, "New Information on Lead in Dirt and Dust as Related to the Childhood Lead Problem," *Environmental Health Perspectives* 7 (May 1974): 83–89. <http://www.ncbi.nlm.nih.gov/pubmed/4831152>

Turner, 1897. Turner, J.A., "Lead Poisoning Among Queensland Children," *Australian Medical Gazette* 16: 475–479.

Warren, 2002/ C. Warren, "Old Paint: A Medical History of Childhood Lead-Paint Poisoning in the United States to 1980," *JAMA*, 287: 916-917.

Williams, 1952. Williams, H., E. Kaplan, C.E. Couchman, and R.R. Sayres, "Lead Poisoning in Young Children," *Public Health Reports* 67: 230–236. <http://www.ncbi.nlm.nih.gov/pmc/articles/PMC2030733/pdf/pubhealthreporig01075-0010.pdf>

Chapter 2: Where To Go For Help – Qualifications, Roles and Resources

I. Introduction	2-3
II. Housing	2-3
A. Owners	2-3
B. Residents	2-5
C. Property or Project Managers	2-6
D. Architects/Engineers/Rehabilitation Specialists	2-6
E. Housing and Code Inspectors	2-7
F. Lead Hazard Control Supervisors and Workers	2-8
1. Abatement.....	2-8
2. Interim Controls	2-9
G. Public Housing Authorities, Tribally-Designated Housing Entities and Other Housing Agencies	2-9
H. Insurance Companies	2-9
I. Real Estate Brokers and Agents	2-9
III. Health	2-10
A. Public Health	2-10
B. Health Care Providers	2-11
C. Public Health Practitioners	2-12
D. Public Health Departments	2-12
IV. Environment	2-13
A. Risk Assessors, Inspectors, Sampling Technicians	2-13
1. Risk Assessors	2-13
2. Inspectors	2-14
3. Sampling Technicians.....	2-15
4. Finding Qualified Risk Assessors and Inspectors	2-15
B. Waste Managers and Environmental Protection Departments	2-16
C. Other Environmental Consultants	2-17
D. Suppliers	2-18
E. Laboratories	2-19
F. Training Providers	2-20
REFERENCE.....	2-21
FIGURES	
Figure 2.1 Many local health departments distribute information or conduct outreach activities at health fairs or community meetings.....	2-10



Figure 2.2 Risk assessors and property owners planning housing rehabilitation may find an on-site meeting facilitates communication about lead-based paint hazards on a property. 2-14

TABLE

Table 2.1 Owner Responsibilities..... 2-4

Chapter 2: Where To Go For Help – Qualifications, Roles and Resources

I. Introduction

No single discipline or profession is responsible for lead poisoning prevention, which involves housing, public health, and environmental dimensions. This chapter provides information on:

- ◆ Required expertise and qualifications.
- ◆ Sources of assistance for residents or owners.
- ◆ Coordination of work among the various professions.

II. Housing

Because lead-based paint hazards are almost always linked to the condition of the dwelling, housing design professionals, housing or building departments, housing contractors, and property owners are well-positioned to complete and maintain any necessary repairs or improvements in the home environment. Ultimately, owners are responsible for authorizing and financing the work. Although public health and environmental agencies may occasionally exert primary or temporary influence over a dwelling, the role of housing professionals is usually predominant. This section outlines the primary roles, responsibilities and typical qualifications of the primary players in housing and lead hazard evaluation and control.

A. Owners

Property owners have the primary responsibility for identifying and correcting lead-based paint hazards, since they control the dwelling. Owners' responsibilities are listed in Table 2.1 and are distinct from the responsibilities of residents, unless, of course, they are owner-occupants. While owners may choose to delegate authority for lead hazard control projects to project managers, property management companies, environmental consultants, design professionals, or others, they are ultimately responsible for the successful completion of the project. A lead risk assessor or inspector can provide important advice and/or data; however, owners make the final decision regarding the choice of the appropriate lead hazard control treatment. Owners may choose to implement treatments during the vacancy, renovation, or sale of the dwelling (see Chapter 3). Owners are also responsible for ensuring that routine maintenance work is performed safely to prevent the creation of leaded dust hazards. For instance, special cleanup measures may be required for many maintenance jobs that previously involved only a broom sweep. Owners are responsible for obtaining a clearance examination when required. Finally, owners are responsible for determining how projects are to be financed, filling out grant or loan applications (if they are available in the jurisdiction), and making sure that the project goes smoothly. Public housing authorities have found that a periodic onsite appearance by the owner or owner's representative clearly reinforces the importance of the work being done.

How can owners make certain that abatement or interim control work is done properly?

Under Title X, all abatement and renovation work (which includes interim control work as well as a range of other activities; see the Glossary) in target housing must be performed by certified firms, certified supervisors, and trained and, as appropriate, certified workers. The owner of target housing has responsibilities under the Lead Disclosure Rule as well (see Section II.I of this chapter, and Appendix 6).

Table 2.1 Owner Responsibilities

- ◆ Administering the overall project.
- ◆ Acquiring the necessary services from certified risk assessors, inspector, lead hazard control contractors, clearance examiners, trained (and, as required, certified) workers and planners, as appropriate for the project.
- ◆ Providing access to areas to be evaluated or controlled.
- ◆ Selecting and approving lead hazard control measures, with input from risk assessors and others.
- ◆ Revising, as needed, and ensuring implementation of routine maintenance work practices to prevent lead hazards from being generated.
- ◆ Lead disclosure (See Appendix 6): Providing information on lead poisoning, and on the presence of lead-based paint and lead-based paint hazards in the housing, to prospective residents and purchasers.
- ◆ Monitoring conditions to ensure that lead-based paint hazards do not recur and ensuring that periodic reevaluation is performed by a certified inspector or certified risk assessor.
- ◆ Obtaining waste permits, manifests, etc.
- ◆ Financing lead hazard evaluation and control and other aspects of the overall project.

The following landlord associations provide information to their members on owner responsibilities:

Council of Large Public Housing Authorities
 1250 Eye Street, NW, Suite 901
 Washington, DC 20005-3947
 (202) 638-1300
www.clpha.org

Public Housing Authorities Directors Association
 511 Capitol Court NE
 Washington, DC 20002-4937
 (202) 546-5445
www.phada.org

National Apartment Association
 201 N. Union Street, Suite 200
 Alexandria, VA 22314-2642
 (703) 518-6141
www.naahq.org

National Association of Housing and Redevelopment Officials
 630 Eye Street NW
 Washington, DC 20001-3736
 (877) 866-2476 or (202) 289-3500
www.nahro.org

National Multi-Housing Council
 1850 M Street NW, Suite 540
 Washington, DC 20036-5803
 (202) 974-2300
www.nmhc.org

B. Residents

If residents are also owners, their responsibilities are the same as those outlined in the section above. If residents are renters, they typically have certain shared responsibilities with the owners in reducing the risk of lead poisoning in children. Generally, owners are responsible for providing properties that are lead-safe and surfaces that are cleanable. Residents are responsible for performing ordinary household cleaning of those surfaces, particularly floors and exterior and interior window sills. If a potential lead hazard develops (e.g., peeling paint), the resident should report it to the landlord. The Centers for Disease Control and Prevention (CDC) recommends that parents have their young children screened for lead poisoning by no later than 12 months of age, either by their pediatrician or the local health department. This service may be provided at no charge to the parent, depending on the availability of local and/or private funding.

The many sources of public information on lead poisoning include:

National Lead Information Center and Document Clearinghouse, 800-424-LEAD (5323) Hearing- or speech-challenged individuals may access this number through TTY by calling the toll-free Federal

Relay Service at 800-877-8339. The Clearinghouse provides technical assistance by phone to the general public and professionals. It provides many materials, including both Federal lead hazard information pamphlets:

- ◆ *Protect Your Family from Lead in Your Home*, which is available in several languages, including English, Spanish, Vietnamese, Russian, Arabic, Somali; in various graphic formats.)
- ◆ *Renovate Right: Important Lead Hazard Information for Families, Child Care Providers, and Schools*, which is available in English and Spanish.

The Clearinghouse has a document request form on line at <http://www.epa.gov/oppt/lead/pubs/nlic.htm>.

Centers for Disease Control and Prevention’s Healthy Homes and Lead Poisoning Prevention Branch

EPA Regional Offices (see Appendix 3)

Occupational Safety and Health Administration (OSHA) Regional Offices (see Appendix 4)

Local Health Departments

Local Poison Control Centers 800 number

Local Public Housing Authorities or Tribally-Designated Housing Entities (TDHEs)

Local Housing and Community Development Agencies

HUD Office of Healthy Homes and Lead Hazard Control, (202) 755-1785, Ext. 7698,
<http://www.hud.gov/offices/lead>

C. Property or Project Managers

Property managers and management companies may sometimes act as the owner’s designated representative on lead-based paint issues, in which case they assume the owner’s responsibilities described above. These individuals are responsible for acquiring the expertise needed to properly handle potential lead hazards by sending staff members to appropriate training programs or by contracting for services with certified risk assessors, certified inspector, or certified abatement project supervisors.

Real estate agents are often hired by property managers and management companies to handle the sale or lease of housing. These agents assume specific responsibilities under the Lead Disclosure Rule (see Appendix 6).

D. Architects/Engineers/Rehabilitation Specialists

When planning lead hazard control activities in multiple dwellings, an owner may employ architects, engineers, rehabilitation specialists, or other specialists in housing construction. All of these specialists may be considered “planners” (as the term is used in Title X). Title X requires that planners receive training, since most architects, engineers, and rehabilitation specialists do not currently understand the differences between lead hazard control, asbestos hazard control, and ordinary construction work.

Whether or not they are trained and certified as planners, housing specialists should consult a certified risk assessor, certified abatement project supervisor or project designer to acquire this expertise on the planning team. If job specifications are developed, they should be reviewed by a certified risk assessor; if no risk assessor is available, a qualified environmental or health scientist should be consulted. A certified individual may be required in some programs and jurisdictions.

Planning for housing rehabilitation without taking lead hazard control into account can greatly increase the cost of the overall effort. For many small-scale projects (e.g., single-family homes or projects with less than five units), retaining an architect, engineer, or housing rehabilitation specialist may not be feasible or necessary. In this case, a certified abatement contractor or supervisor may need to consult directly with a certified risk assessor and the owner.

Collaboration should occur between the owner and persons knowledgeable about lead hazard control work and construction. Ideally an owner should seek guidance from a risk assessor who has demonstrated knowledge about both construction and lead hazard control. However, often a team effort will be required, with contractors providing expertise on construction, and risk assessors providing information on identifying and controlling lead hazards.

Lists of housing professionals are available from:

American Institute of Architects
1735 New York Avenue NW.
Washington, DC 20006-5292
(800) AIA-3837 or (202) 626-7300
www.aia.org

National Society of Professional Engineers
1420 King Street
Alexandria, VA 22314-2794
(703) 684-2800
www.nspe.org

American Council of Engineering Companies (formerly American Consulting Engineers Council)
1015 15th Street NW, Suite 802
Washington, DC 20005-2605
(202) 347-7474
www.acec.org

E. Housing and Code Inspectors

In many jurisdictions some kinds of lead hazards (such as peeling paint) may be identified in the course of ordinary housing or building code inspections. However, most housing and building inspectors do not currently have the training to recognize all kinds of lead hazards (e.g., leaded dust hazards). Individuals engaging in identification of lead-based paint hazards should be certified or licensed by their State or local approving authority as a lead-based paint risk assessor or inspector.

Some states, tribes and localities have laws, regulations and/or codes that cover the presence of lead-based paint. These regulations may consider whether lead-based paint hazards are present, whether young children reside in the housing, and/or whether the housing is rented or owner-occupied.

Some local jurisdictions have courts that focus on housing, or even only lead-based paint, issues.

F. Lead Hazard Control Supervisors and Workers

1. Abatement

Because lead abatement projects are dangerous, they must, by federal (EPA), state and/or tribal law and regulation, be conducted by certified abatement firms, managed by certified abatement supervisors and performed by certified abatement workers. (See Chapter 12 and Appendix 6.) Lead abatement firms should consider employing or having subcontracts with professionals with construction and/or general carpentry or building renovation experience, in addition to environmental experience. These firms should also carry general liability insurance, workers' compensation, and other insurance. Some owners may require bid, performance, and payment bonding and hazardous pollutant insurance coverage for large jobs.

OSHA has regulations covering workers dealing with lead-containing surfaces. See Chapter 9 and Appendix 6.

In some areas, market forces and government-funded abatement programs have produced a pool of qualified lead abatement contractors. These contractors have invested in training, thus equipping their supervisors and workers with the ability to perform abatement work safely. Since industrial hygienists or professional environmental consultants monitored many of these projects, they are often a good resource for finding qualified contractors.

Lists of certified supervisors in a given locale may be available from:

The Lead and Environmental Hazard Association
 P.O. Box 535
 Olney, MD 20830
 (301) 924-5490
<http://www.lehaonline.org>

The Environmental Information Association
 6935 Wisconsin Avenue, Suite 306
 Chevy Chase, MD 20815-6112
 (301) 961-4999
www.eia-usa.com

EPA (to locate certified abatement firms where EPA administers the certification program):
http://cfpub.epa.gov/flpp/search.cfm?Applicant_Type=FIRM

Local Health Departments

Local Environmental Agencies

Local Public Housing Authorities and Tribally-Designated Housing Entities (TDHEs)

Local Housing and Community Development Agencies

2. Interim Controls

EPA requires that firms and renovators performing renovation (which includes most interim control measures) in target housing and child-occupied facilities be certified under EPA's Renovation, Repair, and Painting (RRP) Rule; similarly, there is an exemption for "minor repair and maintenance" projects (<http://www.epa.gov/lead/pubs/renovation.htm>). HUD's Lead Safe Housing Rule requires that workers trained in lead-safe work practices perform all but the smallest ("de minimis") interim control work in federally owned or assisted target housing; since the EPA's Renovation, Repair, and Painting (RRP) Rule went into effect in 2010, HUD's lead-safe work practices training requirement is satisfied by EPA's renovation certification training requirement.. See Chapter 11, Interim Controls, for more information on this type of work.

G. Public Housing Authorities, Tribally-Designated Housing Entities and Other Housing Agencies

Much lead hazard control work in this country has occurred in housing owned by Public Housing Authorities and Tribally-Designated Housing Entities (TDHEs), which are local and tribal agencies supported by HUD. In addition, many state and local governments have promulgated lead hazard control laws. Representatives from housing authorities and State and local governments can provide various kinds of help and information to owners or residents undertaking lead hazard control work, such as the names of contracting firms. See Appendix 6 for Lead Disclosure Rule discussion.

H. Insurance Companies

All risk assessors, inspectors, contractors, consultants, planners, and waste-hauling companies may need to be bonded and insured. Insurance companies are providing different types of lead insurance. Owners should make certain that any company retained for lead hazard control is insured specifically for lead exposures, and in the case of renovation projects, certified renovation firms would be prudent to have lead insurance. See Appendix 9.1 for more information.

I. Real Estate Brokers and Agents

Pursuant to Section 1018 of Title X and the Lead Disclosure Rule (specifically, 24 CFR 35.94 (HUD's regulation) or 40 CFR 745.115 (EPA's regulation)), real estate brokers and agents who are involved with real estate sale or lease transactions of most pre-1978 housing in compliance are responsible for ensuring that sellers and lessors comply with the applicable disclosure requirements. Agents must inform sellers or lessors that they must provide the agent and buyers or renters with the following before the parties sign the sale or lease.

- ◆ Give an EPA-approved information pamphlet.
- ◆ Disclose any known information concerning lead-based paint or lead-based paint hazards or state there is no such knowledge.
- ◆ Provide any records and reports on lead-based paint and/or lead-based paint hazards which are available to the seller or landlord.
- ◆ Include a Lead Warning Statement and confirmation that the seller or landlord, and all agents involved have complied with all disclosure requirements, as an attachment to the sales contract, or an attachment to, or within the lease contract.
- ◆ Sellers must provide homebuyers a period of time, typically 10 days, to conduct a paint inspection or risk assessment; the buyer may waive this period.

See Appendix 6 for additional Lead Disclosure Rule discussion.

III. Health

Health professionals, including clinical and public health professionals, and health agencies play a leading role in conducting public education campaigns, enforcing local lead control laws, and identifying those children and workers who have already been poisoned (see Figure 2.1).

A. Public Health

In some cases public health agencies can legally mandate changes in the dwelling when a poisoned child has been identified. However, treatment is often limited to providing medical therapies or blood lead screening programs. Reducing exposure (primary prevention) is known to be far more effective than providing medical treatment after poisoning. Because there are still many lead poisoned children and lead hazard control is dangerous work that can exacerbate a given situation if not performed properly, health professionals are often best suited to provide scientific advice and design programs to prevent further poisoning of children or abatement workers by focusing on reducing risk.

The Health Insurance Portability and Accountability Act (HIPAA; P.L. 104-191), and the associated Complete Privacy, Security, and Enforcement (Procedural) Regulation (45 CFR Parts 160 and 164) are Federal controls on health information. HUD's Office of Healthy Homes and Lead Hazard Control (OHHLHC) functions as a public health authority with respect to children who are lead poisoned (CDC/ HUD Correspondence, 2004). Similarly, the EPA also functions as a public health authority in this subject area. Accordingly, the OHHLHC and EPA may obtain health records pertaining to individual childhood lead poisoning cases.



FIGURE 2.1 Many local health departments distribute information or conduct outreach activities at health fairs or community meetings.

B. Health Care Providers

Health care providers can provide expertise on medical surveillance and treatment. Pediatricians often perform routine blood lead screening for their young patients, based on the recommendations from CDC and the American Academy of Pediatrics (AAP). Both organizations now recommend that all children under age 6 be screened routinely for elevated blood lead levels (EBLs) using a blood lead test (not the erythrocyte protoporphyrin (EP) test) (CDC, 1991b; AAP, 1993). Any pediatrician or physician treating children under age 6 should be aware of these recommended medical guidelines.

Organizations that provide information about medical surveillance for lead or blood lead screening include:

U.S. Department of Health and Human Services
Centers for Disease Control and Prevention
National Center for Environmental Health
Healthy Homes and Lead Poisoning Prevention Branch
4770 Buford Hwy., N.E., MS-F60
Atlanta, GA 30341
(770) 488-3000

State and local Childhood Lead Poisoning Prevention Programs (see Appendix 2)

American Academy of Pediatrics
141 Northwest Point Boulevard
P.O. Box 927
Elm Grove Village, IL 60009
(847) 434-4000
www.aap.org

Association of Occupational & Environmental Clinics
1010 Vermont Avenue NW, Suite 513
Washington, DC 20005
(888) 347-AEOC (2632)
www.aoec.org

American College of Occupational & Environmental Medicine
25 Northwest Point Boulevard, Suite 700
Elk Grove Village, IL 60007-1030
(847) 818-1800
www.acoem.org

Local Health Departments (see Child Lead Poisoning Prevention Programs – CLPPP)

Local Poison Control Centers
1-800-222-1222 to reach the Poison Center that serves your area
www.poison.org/otherPC/index.asp

C. Public Health Practitioners

Public health practitioners such as nurses, social workers and community health workers, often are the direct point of contact for blood lead screening programs and often play the role of coordinator between parent, child, physician, and environmental inspector in cases of lead poisoning in children. In many circumstances they conduct the actual blood specimen collection in the home, clinic, or hospital. They are also skilled at communicating information on the sources of lead poisoning and practical ways of reducing exposures.

Organizations that provide information about blood lead screening and sources of lead poisoning include:

American Association of Occupational Health Nurses
2920 Brandywine Road, Suite 100
Atlanta, GA 30341
(770) 455-7757
www.aaohn.org

National Association of Pediatric Nurse Practitioners
20 Brace Road, Suite 200
Cherry Hill, NJ 08034-2634
(856) 857-9700
www.napnap.org

D. Public Health Departments

Many local public health departments conduct lead poisoning prevention services or can arrange for such services. The development of a primary prevention plan, which identifies and removes hazardous sources of lead exposure before children are harmed, is consistent with the recommendations of the 2005 CDC Statement, *Preventing Lead Poisoning in Young Children* (see Appendix 16).

In addition to preventive services, many public health departments have expanded their efforts beyond identifying and medically treating children who are lead poisoned. Many of them use environmental case management to address the needs of lead-poisoned children. This includes education, identification of lead sources, immediate and long-term interventions to reduce lead exposure, and evaluation of the effectiveness of such interventions. Increasingly, public health departments are coordinating their efforts with housing and environmental protection departments to provide comprehensive care for children at risk.

Local health department contacts for lead poisoning services can be provided by:

State Public Health Agencies

Association of State and Territorial Health Officials
1275 K Street, NW, Suite 800
Washington, DC 20005-4006
(202) 371-9090
www.astho.org

National Lead Information Center Clearinghouse
800-424-LEAD, Technical Assistance
www.epa.gov/oppt/lead/pubs/nlic.htm

The National Institute for Occupational Safety and Health's Adult Blood Lead Epidemiology and Surveillance (ABLES) program is a state-based surveillance program of laboratory-reported adult blood lead levels. The program objective is to build state capacity to initiate, expand, or improve adult blood lead surveillance programs which can accurately measure trends in adult blood lead levels and which can effectively intervene to prevent lead over-exposures. More information about the ABLES program is available at <http://www.cdc.gov/niosh/topics/ables/ables.html>.

IV. Environment

There is significant overlap between public health departments, and environmental professionals and agencies that have primary responsibility for ensuring that proposed construction practices in lead hazard control do not harm workers, the environment, or children who return to the dwelling after work is completed. These protections are accomplished by requiring special equipment, containment, cleanup, project monitoring, and waste management. Environmental professionals provide onsite information to owners and health professionals in the form of risk assessments, inspections, clearance examinations, and surveillance of work practices.

A. Risk Assessors, Inspectors, Sampling Technicians

Lead-based paint risk assessors are certified professionals who can identify lead-based paint hazards and provide recommendations to owners on acceptable options for controlling them. Lead-based paint inspectors are trained to identify lead-based paint on a surface-by-surface basis. The EPA has published a rule for the certification and training of lead-based paint professionals; see Appendix 6. Information about locating risk assessors or inspector in your area can be found in Section IV.A.4, below.

The EPA and some states have reciprocity arrangements where they recognize certifications from other jurisdictions. You should check with the appropriate authorities to verify what programs are recognized and whether you qualify.

1. Risk Assessors

Certified lead-based paint risk assessors may perform inspections, post-abatement clearances, lead hazard screens, and risk assessments. The qualifications for certification include passing both an EPA- or EPA-authorized state- or tribal- accredited inspector course and risk assessor course. Some states and tribes require initial training curricula to include hands-on practical exercises and/or practical exam. A candidate must then pass the EPA, state or tribal risk assessor certification exam. In addition, for EPA certification, the candidate must meet one of the following requirements: a) have a Bachelor's degree and 1 year of experience in a related field; b) have an Associate's degree and 2 years experience in a related field; c) be certified as an industrial hygienist, professional engineer, registered architect and/or certification in a related engineering / health / environmental field; or d) have a high school diploma (or equivalent) and at least 3 years of experience in a related field. After completing an accredited training course with a course test and, if applicable, a hands-on assessment, inspectors must be re-certified every three (3) years, unless the accredited training curriculum included a proficiency test, in which case, re-certification is every five (5) years. EPA, States and Tribes charge a fee for certification Other state and tribal requirements may vary.

There are additional skills and experience that an owner may consider when selecting a risk assessor. This experience may include a background in housing construction, rehabilitation, maintenance, and exposure assessment (see Figure 2.2). Architects, engineers, and code enforcement officials may have such experience. Industrial hygienists and other environmental health practitioners generally are experienced in environmental sampling and interpretation of results.

A risk assessor who also has experience in the management, maintenance, and renovation of housing is more likely to be able to make judgments about the quality of the existing housing stock, the likely effectiveness of hazard controls, and the effectiveness of existing management and maintenance operations. Such a risk assessor will be able to make practical recommendations about how to modify existing management and maintenance procedures to minimize lead hazards.

It is important for housing owners to employ a firm and individual with the commitment and ability to address residents' concerns. Risk assessors also should have the ability to communicate effectively and answer questions clearly.

2. Inspectors

Certified inspectors may perform paint testing, paint inspections and post-abatement clearances. To qualify for certification, individuals must pass an EPA- or EPA-authorized state- or tribal-accredited inspector course with a course exam. Some states and tribes require initial training curricula to include hands-on practical exercises and/or practical exam. Where EPA administers the program and in some state-accredited programs, a candidate must also pass the inspector certification exam administered by the EPA or the state. Recertification is generally required every three (3) years. If the accredited course included a proficiency test, candidates must apply for recertification every five (5) years. Costs of certification include training and a certification/licensing fee paid to the state.

Ideally, in addition to training the inspector will also have substantial experience in inspection according to the paint testing procedures in these *Guidelines*. Firms that have experience working with public housing authorities, other housing agencies and childhood lead poisoning prevention programs may be particularly well qualified.

Inspectors should be fully trained and competent in the use of portable X-ray fluorescence (XRF) analyzers and be able to explain protocols for their use, since XRF is the principal means of inspecting housing units. Protocols should include sampling plans for various types of housing, quality control procedures to ensure reliability of measurements, procedures for confirmatory testing, and the documentation required under these *Guidelines* (see Chapter 7). The inspection report should also provide references from previous inspections.



FIGURE 2.2 Risk assessors and property owners planning housing rehabilitation may find an on-site meeting facilitates communication about lead-based paint hazards on a property.

It is important for housing owners to employ a firm and individual with the commitment and ability to address residents' concerns. Inspectors also should have the ability to communicate effectively and answer questions clearly.

3. Sampling Technicians

EPA and some states and tribes certify dust sampling technicians (previously called by HUD "clearance technicians"). They may perform clearance testing on pre-1978 housing that are being cleared after a renovation projects under EPA's Renovation, Repair, and Painting (RRP) Rule, and on pre-1978 housing that is receiving Federal financial assistance or being sold by the Federal government after any of the following activities are performed: interim control activities, rehabilitation that disturbs painted surfaces, and maintenance activities required under HUD's Lead Safe Housing rule to address lead hazards. However, dust sampling technicians are not permitted to conduct clearance after abatement activities, and are not permitted to conduct dust sampling in risk assessments or lead hazard screens. Only certified risk assessors or inspectors can perform such post-abatement clearance testing, and only certified risk assessors can perform dust sampling in risk assessments. EPA's Renovation, Repair and Painting rule defines dust sampling technicians as individuals who perform dust sampling not in connection with an abatement. The RRP rule also provides requirements for training and certification of dust sampling technicians.

4. Finding Qualified Risk Assessors and Inspectors

Although lead hazard evaluation and control activities are highly specialized, as in other professions, the quality of individual providers or firms varies widely across the U.S. Many lead-based paint professionals provide excellent service. However, HUD has also reviewed some reports that failed to meet the minimum EPA requirements, or were unclear or poorly written. Many state regulatory agencies do not have the resources to routinely monitor the quality of lead-based paint evaluation and control services or routinely collect and review evaluation or abatement reports for compliance or quality and monitor based on tips and complaints. Property owners and housing agencies should follow their standard procedures for hiring and compensating any qualified contractor or professional in their area. These steps often include contacting several company references and/or contacting local consumer-oriented organizations or agencies.

Certified risk assessors and inspectors can be identified by contacting the State or local agency responsible for certifying or licensing individuals or by contacting one of the following groups:

EPA website with links to state certification programs:

<http://www.epa.gov/lead/pubs/traincert.htm#where>

State lists of certified firms and individuals.

EPA website with links to EPA administered Accredited Training Programs:

http://cfpub.epa.gov/flpp/search.cfm?Applicant_Type=training

EPA website with links to EPA authorized Accredited Training Programs (38 States, 3 Tribes, Puerto Rico, and Washington D.C.): <http://www.epa.gov/oppt/lead/pubs/nlic.htm>

You may also check with National Lead Information Center Clearinghouse, 800-424-LEAD (5323) (The Clearinghouse provides technical assistance by phone to the general public and professionals.)
<http://www.epa.gov/opptintr/lead/pubs/nlic.htm>

EPA website with links to EPA administered Abatement Contractor certification:
http://cfpub.epa.gov/flpp/search.cfm?Applicant_Type=FIRM

The Lead and Environmental Hazard Association
 P.O. Box 535
 Olney, MD 20830
 (301) 924-5490
www.lehaonline.com

The Environmental Information Association
 6935 Wisconsin Avenue, Suite 306
 Chevy Chase, MD 20815-6112
 (301) 961-4999
www.eia-usa.org

B. Waste Managers and Environmental Protection Departments

Environmental protection departments are organized at the State and sometimes the local level. These departments are often responsible for regulating hazardous wastes generated within their jurisdictions. Some may also require permits for lead hazard control work. Regional EPA offices can provide guidance on the appropriate regulatory agency for any given area. (See Appendix 3 for a list of EPA regional offices.)

Waste management is a complex area that may require special assistance. The local or State agency regulating waste should *always* be contacted to determine applicable requirements. In most cases lead abatement supervisors or risk assessors can provide the necessary information on how to handle and dispose of any hazardous waste. Since hazardous waste is regulated at the Federal, State, and local levels, owners should take steps to ensure that all applicable regulations are followed and that all necessary manifests (forms) and permits have been obtained. Owners are ultimately responsible for proper waste disposal and should make sure that the transporter and disposer have liability insurance that protects the owner. Sources of information on waste management include:

EPA Resource Conservation and Recovery Act (RCRA), Superfund, and Underground Storage Tanks (UST) www.epa.gov/compliance/civil/rcra/rcraenfstatreq.html

National Conference of State Legislatures (NCSL)
 1560 Broadway, Suite 1700
 Denver, CO 80202
 (303) 830-2200
www.ncsl.org

(NCSL can provide information about current State regulations and appropriate State agencies in each area.)

State hazardous and solid waste agencies (see Chapter 10)

Analytical laboratories performing Toxicity Characteristic Leachate Procedure (TCLP) Analysis
(see Section E, below)

Treatment, Storage, and Disposal facilities

Hazardous waste consultants and brokers

C. Other Environmental Consultants

Although a certified lead-based paint inspector or lead-based paint risk assessor should always be used to conduct lead inspections and risk assessments, professionals in a variety of other environmental disciplines can sometimes provide advice. Some environmental disciplines have certification or separate licensing programs; however, a professional certification or license in another environmental, engineering, housing, or building inspection field is no guarantee of competence in lead hazard evaluation or control, although many professionals in these fields will obtain the necessary additional training before undertaking this work. Owners contracting with these individuals should determine if the individuals' previous training, experience, and qualifications are appropriate for housing. In addition, professional liability insurance usually excludes lead hazard control work at this time.

Many (but not all) industrial hygienists are certified by the American Board of Industrial Hygiene after 4 years of experience, achievement of a college degree, and successful completion of an examination on the principles and practice of their professions.

Registered architects, licensed professional engineers, and environmental consultants generally possess a 4- or 5-year accredited professional degree, several years of experience and internships, and successful completion of an examination on the principles and practice of their professions. Most states recognize the registration by the National Council of Architectural Registration Boards.

Certified safety professionals can provide advice regarding safety issues. Specifically, they identify hazards and evaluate them for the potential to cause injury or illness to people or harm of property and the environment, recommend administrative and engineering controls that eliminate or minimize the risk and danger posed by hazards (www.bscp.org).

Organizations involved with these groups include:

American Board of Industrial Hygiene (Certified Industrial Hygienists)
4600 West Saginaw, Suite 101
Lansing, MI 48917
(517) 321-2638
www.abih.org

American Institute of Architects
1735 New York Avenue NW.
Washington, DC 20006
(202) 626-7300
www.aia.org

American Industrial Hygiene Association
3141 Fairview Park Drive, Suite 777
Falls Church, VA 22042
(703) 849-8888
www.aiha.org

American Academy of Environmental Engineers
 130 Holiday Court, Suite 100
 Annapolis, MD 21401
 (410) 266-3311
www.aaee.net

National Council of Architectural Registration Boards
 1801 K Street, NW, Suite 700K
 Washington, DC 20006
 P: (202) 783-6500
 F: (202) 783-0290
www.ncarb.org

National Society of Professional Engineers
 1420 King Street
 Alexandria, VA 22314-2794
 (703) 684-2800
www.nspe.org

Board of Certified Safety Professionals
 2301 W. Bradley Avenue
 Champaign, IL 61821
 (217) 359-9263
www.bscp.org

D. Suppliers

Suppliers can often provide expert advice on products used in lead hazard control projects, such as high-efficiency particulate air (HEPA) vacuums, personal protective clothing, respirators, containment systems, paint removal products, enclosures, encapsulants, and cleaning agents. Owners or contractors should always question suppliers regarding the limitations of the product and obtain references from previous customers.

Local suppliers can be found by consulting the yellow pages or one of the following trade organizations:

The Lead and Environmental Hazards Association
 P.O. Box 535
 Olney, MD 20830
 (301) 924-5490
www.lehaonline.org

The Environmental Information Association
 6935 Wisconsin Avenue, Suite 306
 Chevy Chase, MD 20815-6112
 (301) 961-4999
www.eia-usa.org

E. Laboratories

Analysis of lead-based paint, soil, or dust samples in the laboratory is difficult. Any laboratory performing analysis of lead in housing and child-occupied facilities built before 1978 must be recognized by the EPA's National Lead Laboratory Accreditation Program (NLLAP; <http://www.epa.gov/lead/pubs/nllap.htm>), which, as of the publication of this editions of these *Guidelines*, recognizes four organizations as accrediting bodies that accredit laboratories for lead sample analysis:

American Association for Laboratory Accreditation

American Industrial Hygiene Association Laboratory Accreditation Programs, LLC

ANSI-ASQ National Accreditation Board/ACLASS

Perry Johnson Laboratory Accreditation, Inc.

To gain recognition under NLLAP, laboratories must successfully participate in the Environmental Lead Proficiency Analytical Testing Program (ELPAT) administered by the American Industrial Hygiene Association, and meet other requirements. Other organizations may be recognized as having a competent proficiency testing program in the future. Laboratories must successfully pass the onsite visit and be rated as proficient in ELPAT to be recognized by EPA. Owners, contractors, inspectors, and risk assessors should request a copy of the accreditation certificate and should verify with the appropriate organization that the laboratory under consideration does in fact perform adequately. Currently hundreds of laboratories are participating in NLLAP. Many states require analytical laboratories to be licensed by the state. To identify accredited laboratories in any given area, contact:

American Association for Laboratory Accreditation
5301 Buckeystown Pike, Suite 350
Frederick, MD 21704
Phone: (301) 644-3248
www.a2la.org

American Industrial Hygiene Association
2700 Prosperity Avenue, Suite 250
Fairfax, VA 22031
(703) 849-8888
www.aiha.org

Perry Johnson Laboratory Accreditation, Inc.
755 West Big Beaver Road, Suite 1325
Troy, Michigan 48084
(877) 369-5227
www.pjlabs.com

ANSI-ASQ National Accreditation Board
500 Montgomery Street, Suite 625
Alexandria, VA 22314
(703) 836-0025
www.aiclasscorp.com

National Institute for Occupational Safety and Health (NIOSH) Information Service
800-35-NIOSH
www.cdc.gov/niosh

National Lead Information Center
800-424-LEAD (Ask for the most current list of EPA-recognized laboratories for analyzing lead in paint, dust, or soil.)
www.epa.gov/lead/pubs/nlic.htm

Note that hearing- or speech-challenged individuals may access the federal government numbers above through TTY by calling the toll-free Federal Relay Service at 800-877-8339.

F. Training Providers

Risk assessors, inspectors, lead abatement supervisors, planners, and abatement workers, abatement supervisors, certified renovators, and dust sampling technicians must all be trained by accredited training providers. When contracting for training services, potential trainees should always ask to see proof of accreditation. The State agency responsible for accreditation can be contacted for a list of training providers in any given area (see <http://www.epa.gov/oppt/lead/pubs/traincert.htm>).

Training providers seeking information on instructional design, curriculum development or delivery can contact:

The American Society for Training and Development
1640 King Street, Box 1443
Alexandria, VA, 22313-2043
Phone: (703) 683-8100
Fax: (703) 683-8103
www.astd.org

The National Environmental, Safety and Health Training Association
P.O. Box 10321
Phoenix, AZ 85064-0321
(602) 956-6099
Fax: (602) 956-6399
www.neshta.org

Reference

CDC/HUD Correspondence, 2004. Letter from Dr. Mary Jean Brown and Dr. David E. Jacobs to the directors of all State and local public health agencies.

Chapter 3: Before You Begin – Planning To Control Lead Hazards

HOW TO DO IT	3-3
I. Concept and Purpose	3-5
II. Determining Whether a Long-Term or Short-Term Response Is Appropriate	3-6
III. Review of Existing Conditions and Preliminary Determination of Lead Hazard Control Strategy	3-8
A. Condition of the Property	3-8
B. Age of the Property	3-9
C. Capital Replacement Plans (Expected Useful Dwelling Life)	3-10
D. Management and Maintenance Issues	3-11
E. Resident Population	3-11
F. Local Capacity of Trained and/or Certified Workers and Certified Firms.	3-12
G. Cost and Financing	3-12
H. Preliminary Determination of Lead Hazard Control Strategy	3-13
I. Selecting Lead Hazard Evaluation and Control Efforts	3-14
IV. Lead Hazard Evaluation – Inspection and Risk Assessment	3-16
A. Bypassing the Lead Hazard Evaluation Step	3-16
B. Risk Assessment Costs	3-16
C. Inspection Costs	3-17
D. Key Elements in a Request for Proposals (RFP) for Risk Assessment and Inspection	3-17
E. Monitoring the Risk Assessment/Inspection Process	3-17
F. Reviewing the Risk Assessment Report	3-18
G. Reviewing the Inspection Report	3-18
V. Considerations in Selecting Control Methods	3-18
A. Containment and Resident Protection	3-18
B. Worker Protection	3-19
C. Cleanup and Clearance Requirements	3-19
D. Waste Disposal	3-20
E. Extent of Concurrent Work	3-21
VI. Considerations in Cost Estimating for Lead Hazard Control	3-21
A. Type of Dwelling Unit	3-21
B. Number of Building Components and Paint Layers to Be Treated	3-22
C. Types of Items	3-22
D. Wage Rates	3-23
E. Occupancy Status	3-23
F. Security	3-23

G. Utilities	3-23
H. Clearance and/or Cleaning Verification	3-24
I. Site Access	3-24
J. Job Design in Large Buildings	3-24
K. Waste	3-24
L. Other Costs	3-24
VII. Specifications	3-25
VIII. Pilot Projects	3-25
IX. Coordinating Lead Hazard Control Work with Other Renovation Work	3-25
X. Insurance	3-26
XI. Project Completion	3-26
A. Clearance and/or Cleaning Verification	3-26
B. Final Report	3-27
REFERENCES	3-28

FIGURES

Figure 3.1	Assessing the physical condition of a property.....	3-8
Figure 3.2	HUD’s American Healthy Homes Survey found that, in 2005–2006, most pre-1940 units contained some lead-based paint.....	3-9
Figure 3.3	Worker caulking painted surfaces as part of ongoing lead-safe maintenance.....	3-11
Figure 3.4	Units with children have a higher priority for evaluation and control than other units.....	3-12
Figure 3.5	Determination of Lead Hazard Evaluation and Control Strategy: Decision-making Logic	3-15

TABLES

Table 3.1	Summary of Steps in Planning Lead Hazard Control Projects.....	3-7
Table 3.2	Housing Units with Lead-Based Paint or Significant Lead-Based Paint Hazards	3-9

Chapter 3: Before You Begin – Planning To Control Lead Hazards

How To Do It

1. Determine the most appropriate long-term or short-term evaluation and control response to the lead hazards for a specific property. Select the most opportune time to conduct lead hazard evaluation and control (often during unit turnover, remodeling or renovation work, refinancing, or substantial maintenance activity). Determine whether historic preservation requirements apply to the property.
2. Decide whether Federal, State, or local regulations require specific lead hazard evaluation or control activities.
3. Determine the potential for the property to contain lead hazards. If the dwelling was built before 1978 or if a child with an elevated blood lead level is present (see Glossary for technical definition), a building-related lead hazard may exist. If the dwelling was built after 1978 and no history of lead poisoning is evident, there is very little chance that a lead hazard exists and no further action is required.
4. Consider whether to acquire the services of a risk assessor and/or an inspector technician to perform an evaluation. For large multi-family projects, develop and issue a Request for Proposals (RFP) for inspections and/or risk assessments. If a property owner decides to implement lead hazard controls without a lead-based paint inspection, all painted, varnished, or other coated surfaces should be presumed to have lead-based paint.
5. Conduct an evaluation (i.e., a risk assessment, paint inspection, or a combination of the two). For properties in good condition, a lead hazard screen risk assessment is recommended to determine whether a full risk assessment is necessary (see Chapter 5).
6. If lead hazards are identified or assumed to exist, select specific lead hazard control methods for specific building components. Include waste considerations, management, resident and worker protection, and cost in determining the best method for the property. Determine the methods and the person(s) responsible for obtaining any necessary permits. Obtain a cost estimate from a certified contractor or risk assessor. Cost estimation considerations are outlined in this chapter.
7. Develop specifications for lead hazard control work (usually for large multi-family projects).
8. Conduct pilot projects and revise specifications if necessary (for large multi-family projects only).
9. Schedule other related construction work to coordinate with lead hazard control work.
10. Select a lead hazard control contractor (this may precede the pilot project). Ensure that the contractor has adequate bonding and insurance (if required).
11. Correct pre-existing problems or conditions before beginning lead hazard control work. All work disturbing painted surfaces must be performed in a lead-safe manner.
12. Determine person(s) responsible for monitoring work to ensure safety (supervisor, risk assessor/consultant, owner).

13. Select the qualified independent, certified lead-based paint inspector, sampling technician or risk assessor responsible for conducting clearance testing. Certified risk assessors should conduct the clearance testing if a hazard evaluation was not performed before work began.
14. Conduct lead abatement or interim control work, including notification of lead work to state/local jurisdictions, if required, cleanup and clearance testing.
15. Determine whether Federal regulations or local jurisdictions require issuance of certificates following clearance.
16. If lead-based paint remains on the property, arrange for ongoing monitoring by the owner or owner's representative and an appropriate reevaluation schedule by a certified professional (see Chapter 6).

I. Concept and Purpose

This chapter is designed to help plan lead hazard control efforts. It describes the process of evaluation and control and suggests items to consider in estimating costs and ensuring quality. Included are (1) methods for determining whether risk assessments or inspections are appropriate; (2) the typical phases of lead hazard control projects (both interim control and abatement); (3) the key issues to be addressed at each phase; and (4) sources for more information.

The goal of lead hazard evaluation and control in housing is to correct lead hazards in the safest and most cost-effective manner feasible. In many cases this will require the expertise of trained, licensed or certified professionals. As explained in Chapter 1, evaluation methods include presumption, lead-based paint inspection, risk assessment, a combination of the two, or lead hazard screen. Lead hazard control options generally include interim controls (which includes lead-safe maintenance) or abatement.

Residential property owners should be aware that evaluation and lead hazard control options and common practices in housing may differ from those used in public and commercial properties. Owners of public or commercial properties often perform a lead-based inspection and abate all lead-based paint during renovation, but they do not usually perform risk assessments. This approach eliminates the potential of exposure of maintenance and renovation personnel, reduces the property owner's liability, and may increase the property's value and complexity of sale. However, because of the potential risk to children under age six and pregnant women in housing, residential properties present a different set of considerations. These are discussed in these *Guidelines*.

Although many lead-based paint activities share common elements, they differ in purpose, procedure and the information they provide. It is important that owners and housing agencies, if applicable, select the most appropriate method of evaluation. HUD does not consider a visual assessment to be an evaluation method because it yields no information on lead content of paint. Similarly, simple repair of paint that is disturbed during remodeling is not considered lead hazard control. A lead-based paint inspection does not identify lead-based paint hazards. This is critical in units receiving an average of more than \$5,000 per unit of HUD-funded rehabilitation assistance because HUD requires that all lead-based paint hazards on the property be controlled as part of these projects. In these cases, a risk assessment is required. See the Glossary and Chapter 1 for complete definitions of risk assessment, inspection, interim controls, and abatement.

Thus, property owners have a wide range of evaluation and control options. Unless an owner is required to perform specific lead-related evaluation or control actions, owners may select the combination of activities that is most appropriate for the property. In addition, if specific actions are required, an owner has the flexibility to conduct more stringent or comprehensive actions based on a business decision related to lead or, perhaps, other ownership or management considerations.

Any evaluation method may be followed by either interim controls or abatement, or both may be used on surfaces or conditions in the same property. Risk assessment reports are required to contain prioritized lead hazard control options to the owner, but these options are not required in other evaluation reports. If it is reasonable to presume that painted surfaces contain lead-based paint, and/or to presume that all horizontal surfaces have lead-contaminated dust, and all bare soil is lead-contaminated, it may be cost-effective to skip the evaluation step by presuming the presence of lead-based paint and/or lead-based paint hazards, and then proceed directly to lead hazard control procedures. If an owner presumes the presence of lead-based paint hazards, there are two choices for lead hazard control: abatement of all presumed hazards or "standard treatments," which are equivalent to interim controls (see Chapter 11). This option is discussed further in Section IV below.

In-place management is an option for properties with only intact paint and no lead hazards. If all paint is intact and the owner wishes to defer lead hazard control until the time of planned renovation or unit turnover, a risk assessment is recommended. The risk assessor will identify all dust-lead, friction or impact surfaces, or soil-lead hazards to be corrected before the in-place management program of the intact paint begins.

II. Determining Whether a Long-Term or Short-Term Response Is Appropriate

As discussed above, owners have a wide range of options for lead hazard evaluation and control. The options vary from long- to short-term solutions.

Complete and permanent elimination of all lead-based paint through abatement of all known or presumed lead-based paint is definitely a long-term approach. It can be effective and safe provided that:

- ◆ All types of lead hazards are addressed, including lead-contaminated dust and soil.
- ◆ Workers and residents are not adversely affected during the work.
- ◆ The process is properly controlled so that new lead hazards are not created.
- ◆ Cleanup is adequate as determined by clearance testing.

However, for many owners, abatement of all known or presumed lead-based paint may be unnecessary or too expensive and technically demanding, at least in the short run.

Risk assessment followed by abatement of specific lead-based paint hazards is a more focused long-term approach. It focuses treatment resources on specific hazards. If encapsulation or enclosure is performed, the condition of these treatments should be periodically monitored through a lead-safe maintenance program.

Identifying lead hazards by risk assessment and treating them by using interim control methods (and perhaps abating a few key surfaces) is an effective, short-term alternative. The risk assessment/interim control approach has the advantage of treating the lead hazards to which children are likely to be exposed, while temporarily controlling and monitoring the lead-based paint on an ongoing basis. Some owners may link lead hazard control to remodeling and perform the lead work immediately prior to remodeling. This approach is required in some cases by the Lead Safe Housing Rule (See Appendix 6).

Unless regulated by the local jurisdiction or applicable Federal or State funding program, owners can select whatever strategy they wish, as long as certain prohibited paint removal practices are not used (see Chapter 11) and compliance with clearance standards is achieved when required. This provides substantial flexibility for different types of housing and ownership patterns, permits innovation, and still ensures that dwellings are lead-safe (see the Glossary for the definition of a “lead-safe dwelling”).

To determine the measures that will be most effective and safe for a given property, certain planning steps are appropriate (see Table 3.1). These steps are generally the same for all types of properties, but for smaller buildings and especially single-family homes, some of the steps may not be appropriate, as indicated by asterisks in Table 3.1.

Regulatory requirements may predetermine the lead hazard control strategy as well as when lead hazard identification efforts are required. In a few States, including Maryland and Massachusetts, evaluation and abatement of certain lead-based paint hazards (defined by each State) are mandated, under some circumstances, for rental properties. In many States and local jurisdictions, evaluation and control (to varying standards) are required when a lead-poisoned child is identified. If the dwelling receives Federal housing assistance, HUD's lead regulations for that specific program should be consulted. (HUD's lead regulations vary depending on the type and amount of Federal housing assistance that is provided.)

Table 3.1 Summary of Steps in Planning Lead Hazard Control Projects.

1. Review of existing conditions/preliminary determination of lead hazard control strategy, including historic preservation considerations.
2. Evaluation of lead-based paint and/or lead-based paint hazards.
3. Prepare format for notice of evaluation for presence of lead to residents, if required.
4. Selection of specific lead hazard control methods.
5. Selection of resident protection and worksite preparation level.
6. Development of specifications.*
7. Initiation of pilot project.*
8. Scheduling of other related construction work.
9. Selection of lead hazard control contractors. Notifications to state/local jurisdictions, if required.
10. Lead-safe correction of pre-existing conditions that could impede lead hazard control work.
11. Monitoring the work and cleanup process.
12. Clearance (and certification if required by the local jurisdiction).
13. Prepare format for notice of lead hazard control activities to residents, if required.
14. Arrangement of ongoing monitoring and reevaluation.

* Not necessarily required in single-family dwellings.

III. Review of Existing Conditions and Preliminary Determination of Lead Hazard Control Strategy

The choice of a strategy depends on the extent of the lead hazards that exist and the financial resources available to address them. In addition, before undertaking risk assessment or inspection, certain existing conditions at a property should be reviewed, since they may indicate which lead hazard control strategy is appropriate. The lack of historical evidence of lead poisoning in a particular area should not be considered conclusive when determining whether or not a population is at risk or whether a dwelling unit contains lead hazards. Although in many parts of the country there have historically been few reported cases of lead poisoning, it may be because very few children were tested. With increased public awareness and screening of children for lead poisoning, it is expected that many more children with lead poisoning will be identified. The following general issues should be reviewed:

- a. Condition of the property.
- b. Age of the property (including historic preservation considerations).
- c. Capital replacement plans for the property (or expected useful life).
- d. Ongoing management and maintenance issues.
- e. Existing and potential future occupants.
- f. Regulatory requirements.
- g. Local capacity of trained and/or certified workers.
- h. Financial resources.

Each of these considerations is described below.

A. Condition of the Property

The condition of painted building components should be a primary consideration in devising the overall lead hazard control strategy. Painted building components, especially doors and windows, must have adequate structural integrity in order to support lead hazard control treatments. If components have rotted, are deteriorated to the point where they are difficult to maintain, or if the dwelling unit is subject to recurring water infiltration or other water damage, neither interim controls nor abatement will be effective without a substantial restoration effort. Interim controls and some forms of abatement are likely to have very short lives in these situations. (See Figure 3.1)

Other factors related to the condition of the property that should be considered include the



FIGURE 3.1 Assessing the physical condition of a property.



FIGURE 3.2 HUD’s American Healthy Homes Survey found that, in 2005–2006, most pre-1940 units contained some lead-based paint.

type of building component affected, number and thickness of paint layers, and interior or exterior location on the property. Soil conditions need to be addressed as well.

B. Age of the Property

Age of the property can indicate the amount of lead-based paint likely to be present and the extent of the lead hazard control work that may be necessary. The majority of buildings built before 1978, especially those built before 1960, including most of those built before 1940, contain some lead-based paint (HUD, 2011). For older dwellings, the concentration of lead in the paint is higher. For pre-1950 properties, it is reasonable to assume that lead-based paint is present on more than a few surfaces and that abatement of lead hazards will involve a significant amount of work. Table 3.2 demonstrates the relationship between age

Table 3.2 Housing Units with Lead-Based Paint or Significant Lead-Based Paint Hazards

Year Built	Total	Lead-Based Paint		Significant Lead-Based Paint Hazards	
		Number	Percent	Number	Percent
All Years	106.033	37.058	34.9%	23.186	21.9%
1978-2005	40.458	2.675	6.6%	1.083	2.7%
1960-1977	29.956	7.376	24.6%	3.415	11.4%
1940-1959	18.117	11.921	65.8%	6.999	38.6%
Pre-1940	17.502	15.085	86.2%	11.689	66.8%

Note: Numbers of housing units in millions. Significant lead-based paint hazards are those above HUD’s *de minimis* threshold amounts in its Lead Safe Housing Rule. Further details are in the source report.

Source: HUD, 2011. American Healthy Homes Survey: Lead and Arsenic Findings. April 2011. http://portal.hud.gov/hudportal/documents/huddoc?id=AHHS_REPORT.pdf.

and prevalence of lead-based paint as of 2005-2006 (HUD, 2011a); these results confirm the previous national survey on this subject for housing as of 1998-2000 (HUD, 2001a). It is worth noting that there is tremendous variability in houses within each age group. Depending on local conditions, some pre-1950 dwellings may have no lead-based paint at all, while some newer ones built before 1978 may have a considerable amount.

In most properties built between 1960 and 1978, it is reasonable to expect that fewer surfaces with lead-based paint are present. For these properties, a lead-based paint inspection (see Chapter 7) or a lead hazard screen risk assessment (see Chapter 5) is often most cost effective to determine whether lead-based paint or lead-based paint hazards, respectively, are present. These newer properties still require hazard evaluation, since there is some evidence that significant levels of lead-based paint were sold up to at least 1971 (*New York Times*, 1971).

It is unusual but not impossible to find lead-based paint in houses built after 1978. For example, as of 1992, some health departments still periodically confiscated new residential paint containing illegal amounts of lead (Massachusetts, 1992). Starting in 1978, the Consumer Product Safety Commission permitted no more than 600 µg/g (0.06 percent; 600 parts per million (ppm)) of lead in residential paint. Effective August 14, 2009, following reports of imported toys with lead-containing coatings and enactment of the Consumer Product Safety Improvement Act of 2008, this limit was reduced to 90 parts per million (CPSC, 2009). Thus, because the use of lead in paint had almost ceased by 1978 and because of the need to focus scarce resources, houses built after 1978 are not targeted for inspection or risk assessment, unless a child with lead poisoning is identified (see Chapter 16). In some dwellings, historic preservation requirements may apply (see Chapter 18).

C. Capital Replacement Plans (Expected Useful Dwelling Life)

Future plans for the building play an important role in deciding whether long-term or short-term approaches are best. For example, if the building is expected to be demolished within 3 years, a substantial investment in lead-based paint abatement makes little sense if interim controls will adequately control the hazard(s) identified. In this case a risk assessment and interim controls are clearly best. If no children or pregnant women will live there, hazard control measures need only protect the environment and maintenance and demolition workers. Integrating lead abatement into substantial comprehensive renovation projects may be efficient and required for safety. Before capital replacement projects are performed, all painted surfaces to be disturbed should be tested for lead. It is probably cost-effective to perform a complete lead-based paint inspection at this time to determine whether additional work can eliminate other lead-based paint on the property at the same time. Inspection is especially important if the construction process will disturb painted surfaces and generate a substantial amount of dust. If lead-based paint is present in such a project, the renovation process should be designed to prevent leaded dust from being dispersed throughout the housing environment. If no lead-based paint is found, construction work can proceed in the usual fashion using traditional construction methods. If exterior soil is being disturbed, a lead hazard may remain from past use of lead-based paint or other sources (e.g., lead gas emissions, industrial effluent, etc.). If replacement or enclosure of certain components is already planned, this work may accomplish abatement of those components. These components should be inspected to determine whether the project requires additional safety controls. For building components that can be readily removed or enclosed without generating significant amounts of leaded dust, the work can usually proceed safely with the addition of a few simple controls.

If asbestos abatement or other environmental remediation is planned, it may be cost-effective to combine this work with lead abatement. Although there are some important differences, many requirements for containment and cleanup for both lead and asbestos abatement are similar (for example, use of high-efficiency particulate air (HEPA) vacuums and personal protective equipment). Therefore the same firm may be able to carry out both types of work, if certified to do both. Individuals experienced in performing combined abatements should be consulted to develop specifications for these types of projects.

D. Management and Maintenance Issues

Abatement is a permanent response to lead hazards; interim controls are temporary and require periodic checks. Both methods can produce lead-safe dwellings. Abatement normally requires an intensive effort at considerable inconvenience, but can usually be completed within a brief timeframe. To be consistently effective, interim controls require an ongoing effort as well as some inconvenience and expense at periodic intervals.

For example, painted surfaces must be examined regularly and kept in good condition (see Figure 3.3). If significant dust or soil hazards were found on risk assessment, dust and soil sampling may have to be repeated on a regular basis. If recontamination occurs after interim controls, cleanup and paint stabilization will have to be repeated. In addition, individuals performing interim controls in federally assisted housing must complete a HUD-approved curriculum in lead-safe work practices (www.hud.gov/offices/lead/training/). EPA requires that firms and renovators performing renovation in pre-1978 “target”

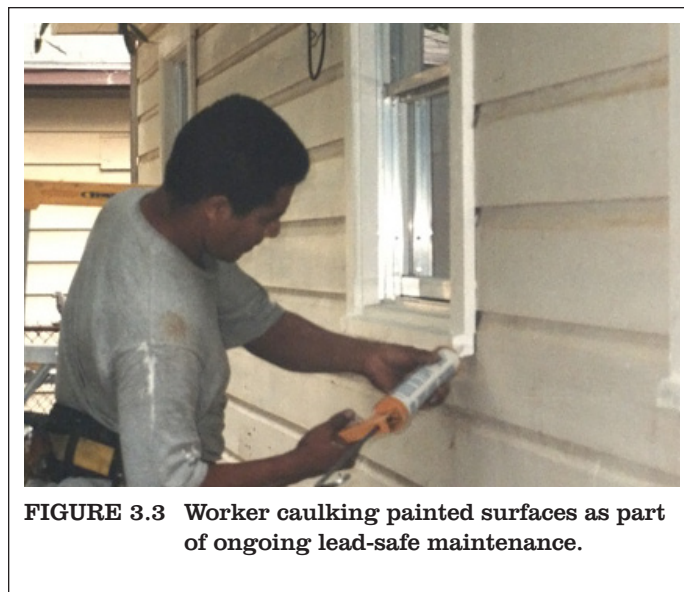


FIGURE 3.3 Worker caulking painted surfaces as part of ongoing lead-safe maintenance.

housing and pre-1978 child-occupied facilities be certified under EPA’s Renovation, Repair, and Painting (RRP) Rule (See Appendix 6) (www.epa.gov/lead/pubs/renovation.htm).

The interim control option requires that control of lead hazards becomes a formal part of normal property management. Owners and managers may choose to focus resources on a one-time, permanent abatement solution unless they are willing and able to carry out such a management regimen. Others may decide that ongoing lead-safe management is appropriate for them. Regardless of the lead hazard control option chosen, the dwelling unit must be made lead-safe.

E. Resident Population

Children under 6 years old are especially at risk for lead poisoning and are most likely to be impaired as a result of exposure (CDC, 1991b). Dwelling units where young children currently reside, or vacant units that may be occupied in the near future by a family with a young child,

should be given high priority for hazard control. Pregnant women also are at risk, so units with pregnant women are also high priority (see Figure 3.4). Eventually, *all* older dwellings will require treatment, since one cannot predict with certainty which dwelling units will house children or pregnant women.

It is worth noting that owners who refuse to rent dwellings to families with young children or pregnant women may be in violation of the Federal Fair Housing Amendments Act of 1988.

F. Local Capacity of Trained and/or Certified Workers and Certified Firms.

Many geographic areas of the U.S. have developed an adequate capacity for performing evaluation and abatement and have a mature network of firms available to do this work. In other, especially rural, areas of the country, certified evaluation, renovation, and abatement firms are still needed. Trained interim control workers are also in short supply in some parts of the country. Because travel costs add to the total price of any construction project, owners should assess their local capacity for trained and/or certified workers working for certified firms, when developing their lead hazard control strategy. EPA requires that firms and renovators performing renovation in target housing and pre-1978 child-occupied facilities be certified under EPA's Renovation, Repair, and Painting (RRP) Rule (www.epa.gov/lead/pubs/renovation.htm; see Appendix 6).

G. Cost and Financing

The cost of lead hazard control varies enormously with the size and condition of the dwelling unit and the soil at the dwelling site, the treatments selected, contractor capacity, local wage rates, the competitiveness of the market, and other factors.

In 2001 the President's Task Force on Environmental Health Risks and Safety Risks to Children estimated the incremental rehabilitation cost for interim controls in Federally assisted housing (including interior and exterior paint stabilization, repair of window friction surfaces, clean up, clearance testing, relocation, administrative and other costs) at \$2,500 per housing unit (President's Task Force, 2001). The estimate for abatement of lead hazards was \$9,000. Abating all hazards in older dwelling units with substantial deferred maintenance can be much more expensive. Owners should not assume the cost of abatement is prohibitive until proper inspection has been completed, lead hazard control options have been identified, and costs have been estimated by qualified abatement contractors. Variables that should be considered in constructing a reliable cost estimate are described in Section VI of this chapter.

In the short run, interim control is far less expensive than abatement. In the long run, interim control may eventually exceed the cost of abatement due to ongoing maintenance, reevaluation, and cleanup.

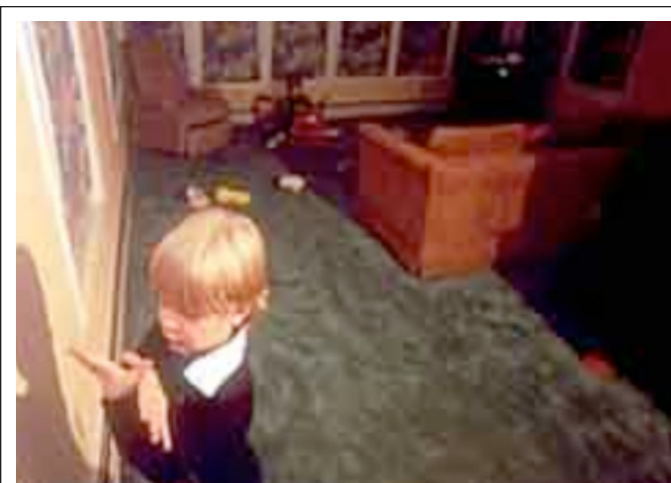


FIGURE 3.4 Units with children have a higher priority for evaluation and control than other units.

Some properties may be eligible for loans and grants under public programs usually administered by State or local housing and/or health departments. HUD has many programs that help owners rehabilitate their properties and include lead hazard control elements. If private loans are to be used to finance the project, the properties and the lead hazard control project will probably need to meet the requirements for home improvement (generally only available for owner-occupied properties) or other equity-backed loans (first and second mortgages). Financing for these activities will be subject to the same loan underwriting requirements that apply to other types of building improvement financing. Such programs generally favor substantial capital improvements that can clearly be shown to increase the value of the property. Information on HUD's programs and how to contact a local or regional HUD office is available at: www.hud.gov.

H. Preliminary Determination of Lead Hazard Control Strategy

After reviewing these issues, the next step is to decide on an overall lead hazard control strategy to minimize the likelihood of a child under six with an elevated blood lead level (EBL).

- ◆ In some situations, a child with an EBL may already be present. If the local health department does not investigate or issue an abatement order requiring the owner to investigate and the child has an environmental intervention blood lead level (EIBLL), the owner should investigate the situation in accordance with Chapter 16 (see Option 4 in Figure 3.5). The owner should determine whether any other rules apply (e.g., HUD's Lead Safe Housing Rule (LSHR)). If so, the owner should determine which requirements are the most stringent. The owner should use the more stringent protocol at all times. (For information on the LSHR see Appendix 6)
- ◆ If no children are known to have an EBL or an EIBLL in a building built before 1978, the owner should determine whether the LSHR applies.
 - If so, the owner should use the LSHR or a more stringent protocol.
 - If not, the owner should determine whether any laws or regulations regarding historic preservation apply to the property. If historic preservation is an issue, Chapter 18 should be followed. Otherwise, the owner should determine whether any other government laws or regulations apply to the situation such as during renovation, remodeling, painting activities or interim control of lead-based paint hazards that will disrupt more than small amounts of lead-based paint and is therefore covered by EPA's Renovation, Repair, and Painting Rule (40 CFR part 745, especially subpart E), and, if the housing is HUD-assisted, HUD's LSHR (24 CFR part 35, especially subpart R). (See Appendix 6)

If none of the above conditions apply, the owner will need to select an appropriate course of action including an evaluation option, which may be a: 1) LBP risk assessment, 2) LBP paint inspection, 3) combined LBP inspection and risk assessment, or 4) no evaluation (i.e., you have no children residing in your housing and you plan to sell the property within the next twelve months). Alternatively, the owner may decide to skip the evaluation step and perform a set of standard treatments to address all potential hazards.

Based on the preceding information, the owner's decision will depend on two major factors:

- ◆ Whether or not the owner foresees that children under 6 years of age will reside in the property, and
- ◆ What level of risk the owner is willing to assume associated with a lead-poisoned child residing in the property.

In order to find the appropriate evaluation option for the level of risk tolerance using the table in Figure 3.5, the owner will probably consider many factors. Some of the common concerns affecting the choice include, but are not limited to:

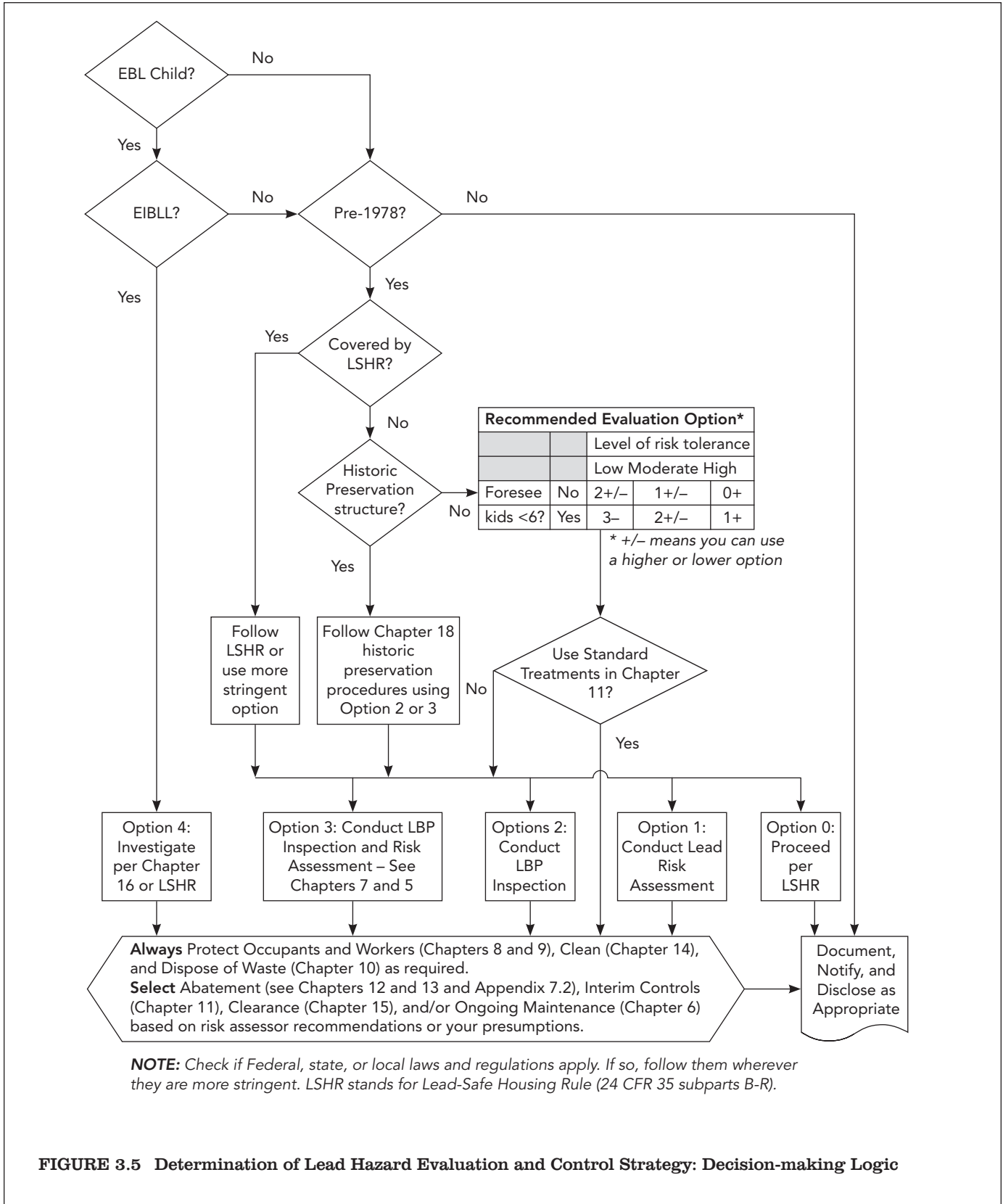
- ◆ How long the owner plans to control or own the property.
- ◆ Whether the owner receives HUD assistance now, or is likely to in the future.
- ◆ The financial cost of taking action or of not taking action:
 - the total cost; and
 - the distribution of the expenditures over time.
- ◆ The owner's legal and regulatory liability, and the benefit of decreased liability.
- ◆ The financial benefits of increased value of a clean or improved property.
- ◆ The operational benefits of:
 - improved landlord-tenant relations;
 - marketing advantages of lead-safe housing units; and
 - public relations.

Because the table in Figure 3.5 breaks the spectrum of risk into three broad categories, there is a "+" and/or "-" in many cells. Owners may choose the primary option identified in the cell that matches your acceptable level of risk and expectation regarding children, or do more or less. Figure 3.5 also lists the various mitigation activities available depending on the outcome of a LBP evaluation.

Regardless of what evaluation option and subsequent lead hazard control activity selected, owners still need to document each decision. For example, owners must make appropriate disclosure when selling or leasing housing units in accordance with the Lead Disclosure Rule (24 CFR 35, subpart A) as well as notify tenants when receiving HUD assistance in accordance with the Lead Safe Housing Rule (24 CFR 35, subparts BR) (See Appendix 6).

I. Selecting Lead Hazard Evaluation and Control Efforts

The factors outlined above should assist a property owner with multiple housing units in deciding where to focus initial attention. It may not be feasible for owners to have risk assessments or inspections performed simultaneously at all properties. As long as the owner plans to identify all lead hazards in all dwellings in a timely manner, prioritizing units may be acceptable. For example, risk assessment and lead hazard control during unit turnover eliminates the expense associated with resident relocation. Older properties should generally be evaluated first, since they are more likely to contain lead-based paint. Dwelling units housing or likely to house children should also receive priority attention.



NOTE: Check if Federal, state, or local laws and regulations apply. If so, follow them wherever they are more stringent. LSHR stands for Lead-Safe Housing Rule (24 CFR 35 subparts B-R).

FIGURE 3.5 Determination of Lead Hazard Evaluation and Control Strategy: Decision-making Logic

Unless prescribed by Federal, State, or local law, decisions on prioritizing are the responsibility of the owner and will need to be made on a case-by-case basis. This flexibility should provide the foundation for keeping costs as low as possible. The prioritized schedule should be documented in a lead hazard control plan.

IV. Lead Hazard Evaluation – Inspection and Risk Assessment

The review of existing conditions will usually determine whether the property owner should arrange for an inspection to determine the location and concentration of lead in painted and varnished surfaces or a risk assessment to identify lead hazards. If the property owner is considering abating all lead-based paint in the property, a certified inspector technician should be retained to identify lead-based paint locations and amounts. If no decision as to interim control or abatement has been made, a certified risk assessor should be retained to sample dust and soil and suggest specific interim controls and/or abatement methods to control lead-based paint hazards.

A. Bypassing the Lead Hazard Evaluation Step

In some cases where local laws or regulations prescribe lead hazard control measures or where there is every likelihood that lead-based paint hazards are present, the property owner may decide to forego lead hazard evaluation and proceed directly to lead hazard control. In such cases, the property owner should presume that all painted and varnished surfaces are lead-based-painted components and that all possible lead hazards are present in the unit (and common areas, for multi-family property). Conduct clearance examinations following lead hazard control treatments to insure no hazards are overlooked since the initial evaluation was not performed. When it is likely that only some of the surfaces to be treated contain lead-based paint (as is often the case in homes built after 1960), an inspection or risk assessment may be more cost effective than bypassing this step, since up-front evaluation enables the lead hazard control activities to be more focused. This is due in part to the fact that only a small proportion of interior surfaces will contain lead-based paint.

For properties covered by the Lead Safe Housing Rule, where interim controls are required, the designated party has the option to presume that lead-based paint or lead-based paint hazards or both are present throughout the residential property. In such a case, evaluation is not required. Standard treatments shall then be conducted in accordance with 24 CFR 35.1335 on all applicable surfaces, including soil, in lieu of interim controls of identified hazards. Standard treatments are completed only when clearance is achieved in accordance with 24 CFR 35.1340 (See Appendix 6).

B. Risk Assessment Costs

Risk assessment costs per dwelling unit vary according to the type of housing being studied. The cost per dwelling unit is lower in large multi-family housing than in single-family or small multi-family housing because environmental sampling is not required for every dwelling in large projects (see Chapter 5). For example, for an apartment complex with 200 similar dwellings, only 20 dwellings would have to be entered and sampled for risk assessment purposes, provided that construction and painting histories are uniform throughout the complex. Costs vary depending on local market conditions (see the economic analysis of HUD's Lead Safe Housing Rule at www.hud.gov/offices/lead/library/enforcement/completeRIA1012.pdf).

In the public housing program, about 50 percent of the cost of a risk assessment is attributable to the cost of analyzing environmental samples; the balance consists of activities such as visual assessment, data collection, sample collection, and report writing (HES, 1993). If extensive paint chip or soil sampling is required due to the presence of a significant amount of paint in poor condition, the sampling costs will be higher. Since these conditions can only be determined in the field once the work starts, the risk assessor should provide a separate unit price for collection and analysis of additional samples.

C. Inspection Costs

The cost of inspection depends on the number of surfaces that must be tested, which in turn depends on the number of painted components. A typical 2-bedroom apartment or small house (5 to 7 rooms) has 40 to 80 painted interior components and 5 to 15 exterior components, all of which will need to be tested. A large single-family house may have far more surfaces to be tested, depending on the number of rooms, painted components in each room, exterior components to be tested, and surfaces that require confirmatory laboratory analysis of paint chips. A typical apartment unit or small-to-average single-family house can usually be tested in 2 to 3 hours by one person operating a single X-ray fluorescence (XRF) analyzer. An additional hour for report preparation is typically needed. Using the protocol in Chapter 7 and current XRF technology, it is not possible to inspect units for \$35–\$45, despite claims by some inspectors to the contrary. Owners are advised to examine closely the competence of inspectors submitting bids. In rural areas, travel costs may be added to the inspector's price.

D. Key Elements in a Request for Proposals (RFP) for Risk Assessment and Inspection

Most public agencies are required to advertise publicly an RFP for consultant services, such as risk assessment and inspection, depending on the estimated value of the services. Although this is not a requirement for most private-sector solicitations, it is still advisable to draw up a list of the information that each proposal should include and a list of factors by which different proposals can be competitively evaluated.

A sample RFP for a risk assessment is provided in Appendix 7.1. Such an elaborate proposal is not necessary in situations where agreements can be reached by private negotiation (for example, a risk assessment for a single-family home), but the major elements should still be considered before a proposal is accepted.

E. Monitoring the Risk Assessment/Inspection Process

The owner should monitor the risk assessment or inspection to ensure that all dwelling units and surfaces to be tested are in fact examined. There have been reports of inspectors providing fictitious testing data or skipping surfaces or even entire dwelling units. One way for the owner to ensure that services are delivered properly is to inform the inspector that a third party will repeat some of the testing as a quality control check. Alternatively, the owner can conduct unannounced surveillance of the testing campaign or can accompany the inspector/ risk assessor as the work proceeds (see Chapter 7 for a detailed quality control plan for paint testing).

F. Reviewing the Risk Assessment Report

The contents of a risk assessment report should closely follow the format described in Chapter 5. The risk assessment report should provide clear information on all environmental samples taken and the laboratory results. It should include a section detailing the lead hazard control options (i.e., what the owner should do) for each of the lead hazards identified. For all lead hazard control methods except complete lead-based paint removal (via building component replacement or paint removal), a plan for ongoing monitoring and professional reevaluation should be described (see Chapter 6). Also the report should explain precautions needed to avoid creating additional lead hazards in the future. A list of hazards with attached laboratory results is not an adequate risk assessment report.

G. Reviewing the Inspection Report

As discussed in Chapter 7, the inspection report should provide clear and concise information about the amounts and locations of all lead-based paint on the property, its outbuildings and other structures (fences, etc.). The report should state which components contain lead-based paint and which do not. The owner should be able to reconstruct the testing and reconstruct the exact places where paint was tested. It should include documentation demonstrating that the testing work was done in conformance with the protocols in Chapter 7 and the inspector's certification information and signature. The report should contain in the body or as attachments, schematic floor plans for each unit or area indicating exact test locations, all raw measurement data, and the results after averaging and correction for substrate interference (if applicable). The report should document that an acceptable sampling scheme was followed. A table of confirmatory paint chip test results and a summary table that shows the percentage of each component testing positive, negative, and inconclusive (multi-family housing only) should be included. The decision-making rules for classifying all surfaces in a dwelling (as outlined in Chapter 7) should be explained and applied properly. The information that the owner must disclose should be identified. Finally, the report should include any recommendations for further testing. A cover sheet with attached XRF results is not an adequate inspection report.

V. Considerations in Selecting Control Methods

This section summarizes factors that should be considered in the selection of lead hazard control methods or before starting a renovation, repair or painting job that will disturb lead-based paint. (Specific techniques and the advantages and disadvantages of each type of lead hazard control are described in Chapters 11, 12, and 13). Before implementing the control measures, whether they be abatement or interim controls, decisions must be made regarding protective measures, the degree of containment (to protect residents), worker protection, cleaning and clearance, and waste management.

A. Containment and Resident Protection

Resident protection is an essential component of all lead hazard control work conducted in occupied units. Containment is also required to prevent dispersal of lead into soil or nearby dwellings. These measures are implemented by selecting one of the Worksite Preparation Levels described in Chapter 8. The Worksite Preparation Level should be defined in the project specifications. If there are no specifications, the certified contractor can select the level. The contractor and the property owner share responsibility for ensuring that a proper containment is maintained for the type of activity

performed. In all circumstances, residents and pets must never be permitted to enter the work area while work is underway. In some cases lead hazard control work can take place if the residents leave for the day or do not enter the work area until cleanup and clearance have been completed.

B. Worker Protection

The Occupational Safety and Health Administration (OSHA) regulations require that workers be protected whenever they are exposed to airborne leaded dust above certain levels or are performing certain construction tasks (29 CFR 1926.62) (See Appendix 6). (Maintenance work not associated with construction activities is covered by 29 CFR 1910.1025.) Many states have their own occupational safety and health programs approved by OSHA. These state plans must have job safety and health standards that are at least as effective as the corresponding federal standards. As of 2011, 28 states and jurisdictions had complete State Plans covering both the private sector, and state and local government employees; and 5 covered public employees only (<http://www.osha.gov/dcsp/osp/index.html>). (Federal employees are covered exclusively by OSHA.)

At this time no lead hazard control technique (even encapsulation or enclosure) is automatically exempt from worker protection requirements. However, it is possible for employers to show that some of the requirements are not applicable by generating objective data from jobs in similar housing using corresponding methods with the same workers. Unless monitoring is completed showing that airborne lead levels are well below Federal or state exposure limits, abatement workers should wear half-mask respirators fitted with the correct HEPA filter for leaded dust particles and protective clothing, exercise proper personal hygiene (preferably onsite showers), and undergo medical surveillance. These measures will also prevent workers from taking home leaded dust on their shoes and work clothing, where their own children could be exposed. Some of these protective measures may not be necessary for low-level interventions (wet cleaning, for example). HUD's interim controls training curricula recommend a minimum of N-100 respirators for maintenance and interim controls workers. The cost of meeting occupational safety and health requirements must be taken into account in any lead hazard control effort. Chapter 9 provides further guidance on implementing the OSHA lead construction standard in the housing industry.

C. Cleanup and Clearance Requirements

The lead hazard control method selected will determine the extent of the cleanup required. For jobs that generate very low amounts of lead dust, careful wet cleaning alone may suffice. For most interim control and abatement jobs, a HEPA vacuum cleaning, followed by a wet wash, and final cleaning with the HEPA vacuum, is the best way of meeting clearance standards. For jobs generating more leaded dust, one or more HEPA/wet wash/HEPA cycles may be required (see Chapter 14).

Check your work carefully for lead dust because hazardous amounts may be minute and not easily visible. If you see any dust or debris, then re-clean the area.

EPA regulations (for pre-1978 target housing and pre-1978 child-occupied facilities) and/or HUD regulations (for pre-1978 target housing receiving HUD assistance) address how, after the substantive work of the project has been completed, and all visible dust and debris have been cleaned up, to determine whether the project has been conducted in a way that allows the work area to be released to residents:

- ◆ For abatement projects, a visual evaluation and dust sampling and analysis of the dust (“clearance testing”) demonstrating that no lead hazards remain in the work area have been completed are required. (This EPA requirement is explicitly incorporated into HUD’s Lead Safe Housing Rule (LSHR).)
- ◆ For non-abatement projects covered by HUD’s LSHR, a visual evaluation and clearance testing are required, except for paint disturbances of very small, “*de minimis*,” amounts (e.g., 2 square feet per room).
- ◆ For non-abatement projects covered by the EPA’s RRP Rule but not HUD’s LSHR, clearance is not required by EPA, but EPA’s “cleaning verification” procedure is, except for paint disturbances of small, “minor repair and maintenance” amounts (e.g., 6 square feet per room). HUD recommends clearance for these projects.

See Chapter 6 regarding the rules discussed above.

If work was not completed, if visible dust or debris remains, or if an excessive amount of leaded dust remains, additional work and cleanup are required until final clearance is achieved (see Chapter 15 for more detailed information on the clearance process). If clearance or cleaning verification, as applicable, show that all work was performed satisfactorily and that leaded dust is not present above clearance standards, then the area can be considered to be safe for residents.

On jobs covered by EPA’s RRP Rule but not HUD’s Lead Safe Housing Rule, certified renovators must perform a final clean-up check. They must use disposable white cleaning cloths to wipe the window sills or the work area floor (in 40 square foot segments) and compare them to a gray cleaning verification card to determine whether the work area was adequately cleaned. If the cleaning cloth is cleaner than the example cleaning cloth on the cleaning verification card, then that surface section has been adequately cleaned. If not, the contractor must re-clean that surface section and conduct another cleaning verification. If the second cloth is not cleaner than the cleaning verification card, the contractor waits for 1 hour or until the surface section has dried completely, whichever is longer. Then the certified renovator wipes the surface section with a dry electrostatic cleaning cloth, and EPA considers the surface clean. (See EPA’s brochure, [Steps to LEAD SAFE Renovation, Repair and Painting; www.epa.gov/lead/pubs/steps.pdf](#).) To order a cleaning verification card and detailed instructions visit EPA’s website at [www.epa.gov/lead/pubs/renovation.htm](#) or contact the National Lead Information Center at 1-800-424-LEAD (5323); hearing- or speech-challenged individuals may access this number through TTY by calling the toll-free Federal Relay Service at 800-877-8339.

At the end of a HUD-funded non-abatement job disturbing paint of more than the Lead Safe Housing Rule’s *de minimis* amounts, a clearance examination is conducted to document that the area is safe to be reoccupied and cleaning was adequate. (Chapter 15 explains clearance requirements.)

D. Waste Disposal

In 2000, EPA clarified its policy with respect to the status of waste generated by contractors as well as residents from lead-based paint activities conducted in households (household waste) (EPA, 2000b). The clarification provided that the household waste exemption in the Resource Conservation and Recovery Act (RCRA) applies to waste generated by contractors as well as to waste generated by residents. The household waste exemption applies to all lead-based paint activities, including abatement, interim control, renovation, and remodeling of housing. Types of

housing included in the household waste exemption are single-family homes, apartment buildings, public housing, and military barracks. In 2003 EPA amended its solid waste regulations to codify this policy by issuing two new definitions for “construction and demolition (C&D) landfill” and “residential lead-based paint waste” (EPA, 2003). A summary fact sheet is available through EPA’s municipal solid waste web site at www.epa.gov/wastes/nonhaz/municipal/landfill/pb-paint.htm.

The cost of waste transport and disposal may be a key factor in selecting hazard reduction methods, particularly because it can significantly affect the project budget. Therefore, check with state and local authorities before final selection of lead hazard reduction activities.

E. Extent of Concurrent Work

Lead hazard control measures will be effective only if components and substrates are structurally sound and in reasonably good condition. Structural deficiencies and any possible sources of water infiltration must also be addressed before lead hazard control activities are undertaken. Cost estimates should clearly reflect these additional requirements.

When the work begins, the contractor may need extensive access to the units, common areas, and worksite. Corridors, stairs, elevators, streets, walkways, and site spaces may have to be used for lead hazard control activities. The existing uses of these spaces may have to be suspended until the work is done. Fire escape routes and exits must never be blocked, however, unless alternative routes are approved by local fire authorities.

Mechanical and electrical fixtures may have to be removed before lead hazard control work can be accomplished. For example, if exterior siding is being replaced, light fixtures, electrical power outlets, cable TV conduits, and telephone and water services may impede the work. If interior walls are being abated, electrical fixtures and radiators may have to be removed.

VI. Considerations in Cost Estimating for Lead Hazard Control

The price for a lead hazard control job will depend on the:

- ◆ Hazard control methods/strategies.
- ◆ Building components being treated.
- ◆ Extent of the work.
- ◆ Location of the job.
- ◆ Individual circumstances of the job.

A. Type of Dwelling Unit

Overall, lead hazard control cost depends on the type(s) of units being worked on. Multi-family dwelling units are the least expensive because their size is usually limited and the work is highly repetitive. The cost is much lower than for treatment of a detached single-family house, unless common areas, like stairs and hallways, are included.

A common two-story row house is relatively inexpensive to treat because there are no side windows (except in end units). The price will increase if the row house is three stories, since the third floor adds a flight of stairs and two or more additional rooms. Some turn-of-the-century row houses near the urban centers of older cities are quite sizable, particularly in terms of ceiling height and property depth, and have elaborate moldings; this will potentially increase the cost of the treatment.

Semi-detached dwellings, such as duplexes and triplexes, include a bank of windows going down one side of the home and are comparable to an end-unit row house. Overall, this type of residence has more square footage than the standard row house and treatment price will rise accordingly.

Generally, single, freestanding dwellings are the most expensive to treat. Windows are on all four sides and attics, basements, garages, and elevated porches (both front and back) are common. If the exterior is painted, the lead hazard control cost will be relatively high. In addition, when treating multi-family housing, startup and project management costs can be amortized over the larger number of housing units, thus decreasing the cost per housing unit, even when costs for addressing common areas are taken into account.

These general principles have important limitations. All homes are unique and control requirements are specific to the particular dwelling.

B. Number of Building Components and Paint Layers to Be Treated

The number of components being treated will directly affect the cost. Older houses tend to contain a greater number of components for two reasons. First, a smaller percentage of new houses contain lead-based paint. For example, about 24.6% of homes built between 1960 and 1977 contain lead-based paint, while about 86.2% of those built before 1940 do. Second, older homes also have more decorative components, such as crown moldings, chair rails, wainscoting, and carved fireplace mantels, which are more likely to have lead-based paint than walls and ceilings as a whole. (HUD, 2011) In addition, older homes typically contain more coats of paint. Many layers of paint make paint removal more difficult on these components.

C. Types of Items

The types and ornateness of items to be treated will influence costs. For example, it is expensive to treat flights of stairs with spindles, newel posts, handrails, stringers, and skirt boards. Painted kitchen cabinets are also costly to treat. Homes with radiators are more expensive to treat than homes with hot-air registers that can be replaced inexpensively.

Generally, the more ornate the components and the more difficult they are to work with, the higher the cost of the job. For historic properties lead hazard control may be warranted. Generally, replacement of original components is not desirable, nor is their enclosure or encapsulation, since the detail and the integrity of the trim usually must be preserved. Some strippers may damage plaster and soft woods, and the use of heat guns in a historic dwelling can create fire hazards. Methods must be specifically tailored to the unique circumstances of the individual situation. Typically, restrictions are stringent and costs are correspondingly high for these properties (see Chapter 18).

For abatement, a significant portion of the total cost of treatment (perhaps as much as one-third) of ornate single-family housing may be devoted to enclosed porches with window and screen frames; wood panels with framing under the windows; wide porch pillars; painted porch

steps and floors; porch ceilings and support beams; the cornice, soffit, and fascia; fat “vase” styled spindles; wide upper and lower rails; and the exterior side of the front living room windows within the porch enclosure.

D. Wage Rates

As a general rule, labor accounts for two-thirds of the direct field cost in lead hazard control work. Labor-intensive treatments are generally more expensive. Labor rates are typically higher in projects for which federally specified “prevailing wages” are paid under the Davis-Bacon Act and related acts (see the Department of Labor’s (DOL’s) Davis-Bacon and Related Acts website, www.dol.gov/compliance/laws/comp-dbra.htm, the Davis-Bacon wage determinations issued by DOL, posted by the Government Printing Office at <http://www.wdol.gov/>, and, for HUD-assisted projects, HUD’s Office of Labor Relations website, www.hud.gov/offices/olr/).

E. Occupancy Status

If the lead hazard control job, including clearance, is to be performed so that the resident can return to the dwelling unit each night, or is restricted from certain work areas in progress, then the job will be substantially more complicated than one performed on a vacant dwelling. For example, a bathroom and kitchen must be kept available for the residents.

Should the residents move but leave their belongings in the dwelling (to be moved from room to room or covered to prevent dust contamination), the job will also be substantially more expensive than work performed in a vacant dwelling, for three reasons. First, continually moving furniture and personal effects is labor-intensive. Second, liability for breakage, which includes appliances and electronics, must be considered. Third, moving furniture back into a room may reduce the likelihood of readily achieving the very low leaded dust levels necessary for clearance, if required, when the entire house is completed. For all these reasons, it is preferable to undertake major control projects in vacant units whenever possible.

F. Security

Properties in the care, custody, and control of contractors may be the contractors’ contractual responsibility. Security measures may increase the cost of the job if vandalism or theft is a valid concern.

G. Utilities

The absence of utilities (heat, electricity, and water) necessary to perform certain lead hazard control activities should be factored into the cost of the hazard control. Dwellings that have been vacant for a long period of time can present special problems. In order for paint-removing chemicals to work, encapsulants to cure, and adhesives to dry, the property must have heat in cold weather. If home heating units are not functioning or are missing, then either expensive repairs need to be performed or potentially costly alternatives considered.

Electricity is required for the operation of power tools, HEPA vacuums, and heat guns. Restoring wiring or providing new electrical service to the property is expensive. Using portable generators is often insufficient and inefficient and presents a capital expense and maintenance cost.

Water is required for worker cleanup and for achieving compliance with clearance standards. It would be inconvenient and expensive to transport large quantities of water to and from the property. Water may have to be hauled away if waste systems are not functioning because it cannot be poured into the ground. Discharge must always be coordinated with local water treatment authorities.

H. Clearance and/or Cleaning Verification

As a job is completed, clearance or cleaning verification by an appropriately certified individual is always appropriate and is required for most projects. Downtime caused by delayed cleaning verification, clearance testing, or receipt of clearance results from a laboratory can be costly; proper scheduling is essential.

I. Site Access

Whatever the site, access must be arranged for workers and equipment. Contractors should ensure, prior to the start of the job, that workers have access to the worksite, such as elevators in high-rise buildings. Similarly, in a housing development, the contractor's trucks should have close access to the dwelling units treated.

J. Job Design in Large Buildings

Lead hazard control in large multi-family buildings must be carefully planned to permit efficient phasing of the work. Initially, the owner should plan to set aside available dwelling units for lead hazard control during vacancy turnover. It is likely that the first wave of work will be scattered throughout a housing development or various floors of a multi-family building. Thereafter, these abated vacant units should be filled with residents from a single floor or housing block. It is critical that family size and housing size be matched. The job should then progress in a linear path, from floor to floor and block to block. The residents thereby retain the same neighbors and are not relocated to new areas that affect transportation, merchant relationships, day-care facilities, and school access.

The job can then be executed in a controlled and economical way that saves money and consolidates workers in a given area. Working floor by floor in multi-family housing also mitigates residents' concerns and logistics over worker contamination of common areas.

K. Waste

Costs associated with waste disposal can be substantial. See Section V of this chapter for further details.

L. Other Costs

The following factors can also increase the cost of performing a lead hazard control job:

- ◆ Poorly defined terms and work items, and illogical work sequencing through the dwelling, resulting in missed items and treatment of incorrect items.
- ◆ Delays in resident departure.

- ◆ Dwelling insufficiently cleared of trash and belongings.
- ◆ Weak floors, stairs, or other structural components.
- ◆ Delayed fumigation (if required).
- ◆ Inexperience of personnel.

VII. Specifications

The property owner should consider whether a detailed set of specifications is needed. For most single-family homes, a detailed set of specifications may not be appropriate. However, for large multi-family housing projects, carefully prepared specifications can help prevent confusion in bidding and job completion. It is beyond the scope of these *Guidelines* to provide a model set of specifications that can be tailored to specific properties. However, examples of project specifications are provided in Appendix 7.3. These guide specifications must be tailored to the conditions and project goals and approaches applicable to each individual job.)

VIII. Pilot Projects

The methods of abatement and interim control in these *Guidelines* have been found to be generally safe and effective. Pilot projects can be used to answer a variety of questions, such as whether hazardous waste will be involved, encapsulants will be effective, paint removers will actually work, and excessive levels of dust will be generated, at a particular site. Pilot projects test lead-based paint hazard control strategy on a limited number of dwellings, usually those that are vacant, to determine the feasibility of carrying out such a strategy in the entire multi-family housing development. This usually involves a variety of lead-based paint hazard control treatments that are under consideration for the overall project. Pilot projects are most appropriate when a large-scale multi-family project is being considered and whenever there is uncertainty about the safety and effectiveness of a particular lead hazard control process.

In pilot projects a representative portion of the total project is carried out and carefully evaluated. The pilot project work should be performed as closely as possible to the way the larger project will be performed, including carrying out specific lead hazard control work, scheduling activities, and integrating other work. This type of pilot study should be evaluated by a risk assessor along with environmental sampling to document that the work is being adequately controlled. Pilot projects should be performed in vacant units whenever possible.

IX. Coordinating Lead Hazard Control Work with Other Renovation Work

Lead hazard control work should be coordinated with other renovation work performed as part of the same project (see Chapter 4). For abatement work it is generally preferable, and sometimes necessary, to complete the abatement work *before* all other renovation work. This may permit most of the construction work to be done in a traditional way without extensive worker protection. For example, it would be necessary to remove lead-based paint from certain surfaces in a kitchen or bath before attaching new fixtures or cabinets. This approach simplifies coordination of the subsequent construction work, since renovations are not started until the lead hazard control is complete.

However, for some projects it may be difficult to separate lead hazard control and renovation. In such cases the role of the abatement or interim control contractor may have to be expanded to include general carpentry and other construction activities. Contractors which will be disturbing lead-based paint during the renovation work must be certified renovation firms under EPA's Renovation, Repair, and Painting (RRP) Rule (see Appendix 6), unless the work is abatement (see Chapter 12) or the amount of paint to be disturbed falls within EPA's minor repair and maintenance limits (see Appendix 6). Certified renovation firms, the certified renovators who supervise the projects, and the workers who implement them, must meet EPA or State lead safety requirements. Alternatively, the work of certain trades may have to be done under abatement conditions. For example, for removing and replacing a window and attached trim covered with lead-based paint because the paint is deteriorated, an abatement worker with carpentry skills is valuable. Similarly, in a situation where there is lead-based paint on interior walls and ceilings, it may be more efficient for an electrician to use lead-safe work practices (see Chapter 11) rather than have an abatement contractor remove paint from walls and ceilings.

X. Insurance

Standard insurance policies almost always contain a strict pollution exclusion clause and, therefore, do not cover lead-based paint-related activities. Lead liability insurance has been readily available for several years covering lead-based paint inspection, risk assessment and abatement work. See Appendix 9 for guidance to property owners on the purchase of liability insurance against lead-based paint-related claims. Note that the Lead Safe Housing Rule requires public housing agencies to carry lead-based paint liability insurance for pre-1978 public housing (see 24 CFR 965.215).

XI. Project Completion

No interim control or abatement project is complete until compliance with clearance standards has been achieved, if required, and a final report prepared.

These reports will become an important document that should be transferred from one owner to the next as part of the lead disclosure requirements under Title X. Some jurisdictions may also require that certificates be provided to owners as proof of completion of lead hazard control work; these will also become part of the disclosure record. Owners and clearance examiners are responsible for maintaining such records.

A. Clearance and/or Cleaning Verification

The abatement or interim control work area generally cannot be released to residents until a visual evaluation has been passed and it has been demonstrated that no lead hazards remain in the work area. As discussed in Section V.C, above (and detailed further in Appendix 6):

- ◆ For non-abatement projects covered by the EPA's RRP Rule and not HUD's LSHR, the visual inspection and EPA's "cleaning verification" procedure are required except for small, "minor repair and maintenance projects."
- ◆ For non-abatement projects covered by HUD's LSHR, the visual inspection and clearance are required except for paint disturbances of very small, "*de minimis*," amounts.

For abatement work, EPA requires that an abatement report must be prepared by certified abatement supervisor or project designer to document the work and the control measures used, including the results of clearance testing and all soil analyses (40 CFR 745.227(e)(10)). The abatement report should be provided to the person who contracted for the work and, if different, the property owner.

For interim control work for which HUD requires clearance under the LSHR, a similar clearance report must be prepared (24 CFR 35.1340(c)); it should be provided to the person who contracted for the work and, if different, the property owner. In addition, a notice to occupants of hazard reduction activity (with information specified in 24 CFR 35.125(b)) must be provided within 15 calendar days after the hazard reduction work has been completed.

For non-abatement projects covered by the EPA's RRP Rule and not HUD's LSHR, if dust clearance sampling is performed instead of cleaning verification, the renovation firm must provide a copy of the dust sampling report to the person who contracted for the renovation sooner than 30 days after the renovation has been completed.

B. Final Report

A final report should be prepared by the professional who conducted the clearance examination or, if clearance is not conducted, such as when cleaning verification is conducted, by the project supervisor, to document the work and any ongoing monitoring and professional reevaluation that may be required in the future by the owner. If applicable, the date for the next reevaluation by a certified professional should appear in the report.

References

CPSC, 2009. Interim Enforcement Policy on Component Testing and Certification of Children's Products and Other Consumer Products to the August 14, 2009 Lead Limits, 74 FR 68593, December 29, 2009.

<http://www.cpsc.gov/businfo/frnotices/fr10/comppol.pdf>

EPA, 2003. U.S. Environmental Protection Agency, Criteria for Classification of Solid Waste Disposal Facilities and Practices and Criteria for Municipal Solid Waste Landfills: Disposal of Residential Lead-Based Paint Waste, Final Rule, *Federal Register* 68(117) 36487-36495: June 18, 2003. Accessed 11/18/2011 through

<http://www.gpo.gov/fdsys/pkg/FR-2003-06-18/pdf/03-15363.pdf>.

HES, 1993. Housing Environmental Services, Personal communication from Miles Mahoney on typical findings of risk assessments in public housing, Columbia, Maryland, 1993.

HUD, 2001a. U.S. Department of Housing and Urban Development, National Survey on Lead and Allergens in Housing, Final Report, revision 6, April, 2001. <http://www.nchh.org/Portals/0/Contents/Article0312.pdf>

HUD, 2011. U.S. Department of Housing and Urban Development, American Healthy Homes Survey: Lead and Arsenic Findings. April 2011. http://portal.hud.gov/hudportal/documents/huddoc?id=AHHS_REPORT.pdf

President's Task Force, 2001. President's Task Force on Environmental Health Risks and Safety Risks to Children, *Eliminating Childhood Lead Poisoning: A Federal Strategy Targeting Lead Paint Hazards*, 2001.

<http://www.hud.gov/offices/lead/library/hhi/FedLeadStrategy2000.pdf>

Chapter 4: Lead-Based Paint and Housing Renovation

- I. Introduction 4-3
 - A. Evidence of Lead Poisoning Caused by Improper Renovation 4-4
- II. Lead-based Paint Hazards in Housing Renovation 4-4
 - A. Similarities between Lead Hazard Control Work and Housing Renovation 4-4
 - B. Dust Containing Lead 4-5
 - C. Fumes 4-6
 - D. Paint Chips 4-6
 - E. Exposed Surfaces 4-6
 - F. Soil 4-6
- III. Coordinating Renovation and Lead Hazard Control 4-7
 - A. Phasing projects 4-7
 - B. Concurrent renovation and lead hazard control 4-7
- IV. Safe Renovation Procedures for Pre-1978 Homes 4-8
 - A. Pre-Work Planning 4-8
 - B. Occupant Protection 4-9
 - 1. Education 4-9
 - 2. Containment 4-9
 - 3. Relocation 4-10
 - C. Worker protection 4-11
 - D. Waste Disposal 4-11
 - E. Cleaning Techniques 4-11
 - F. Clearance Testing 4-12
- V. Prohibited Activities 4-12
- VI. Housing Receiving Federal Rehabilitation Assistance 4-12
 - A. Options 4-13
 - B. Notices and Pamphlets 4-13
 - C. Evaluation and Hazard Reduction Requirements for Rehabilitation Activities covered under the Lead Safe Housing Rule 4-13
- REFERENCES 4-14
- FIGURES
 - Figure 4.1 Sanding wooden floors can generate significant amounts of dust. 4-4
 - Figure 4.2 Torching and burning old paint is a prohibited work practice that can generate lead fumes. 4-6



Figure 4.3 This worksite was not properly prepared for lead-disturbing work by removing the occupant's belongings. 4-10

Figure 4.4 HEPA vacuuming is an important step in the specialized cleaning process. 4-10

TABLE

Table 4.1 Similarities between Lead Hazard Control and Renovation..... 4-5

Chapter 4: Lead-Based Paint and Housing Renovation

I. Introduction

This chapter provides general information on the hazards of lead-based paint in various kinds of housing renovation work, including demolition, remodeling, repainting, rehabilitation, weatherization, and other forms of home improvement. If these activities are performed in dwellings built before 1978 where paint is sanded, scraped, or otherwise disturbed, a lead dust hazard may be created if protective measures and special cleanup procedures are not used.

Three federal agencies have regulations that cover renovation work in housing. These are discussed at greater length in Appendix 6.

- ◆ The Occupational Safety and Health Administration's (OSHA's) *Lead in Construction standard* (29 CFR 1926.62) requires certain procedures for construction work (which includes construction, alteration, repair, painting, and/or decorating) that may expose a worker to lead.
- ◆ EPA's *Renovation, Repair, and Painting (RRP) Rule* (40 CFR 745, especially subpart E) requires that firms performing these activities in target housing (which is most pre-1978 housing) or in pre-1978 child-occupied facilities be certified, use trained and certified renovators, and use lead-safe work practices. EPA can authorize states, tribes or territories to administer and enforce an RRP program in lieu of the EPA program. As of the publication of this edition of these *Guidelines*, EPA has authorized over a dozen of these programs.
- ◆ HUD's *Lead Safe Housing Rule* (LSHR; 24 CFR 35, especially subpart J) requires specific lead evaluation and hazard control activities for renovations in HUD-assisted target housing based on the amount of HUD rehabilitation assistance (on a dollars-per-unit basis).

The EPA and HUD rules, but not the OSHA standard, exempt renovations when the paint to be disturbed has been determined to be below the EPA-HUD standard for lead-based paint of 1 mg/cm² or 5000 mg/g (0.5%) of lead. (This was the standard as of the publication of this edition of these *Guidelines*; at that time, in response to a petition received by the EPA on August 10, 2009, the agencies were reviewing the standard. (See <http://www.epa.gov/oppt/chemtest/pubs/petitions.html#petition5> for links to the petition and EPA's response.)

HUD recommends that clearance testing be performed whenever a job creates leaded dust, while EPA's RRP rule allows for cleaning verification with optional clearance testing when required by contract or regulation. For more information on clearance, see Chapter 15.

Contractors who perform most renovation, repairs, and painting jobs in pre-1978 target housing or pre-1978 child-occupied facilities are also required by EPA's renovation regulations to provide owners and tenants of target housing, owners and adult representatives of child occupied facilities, and the parents and guardians of children under age six who use child occupied facilities with a copy of the EPA lead hazard information pamphlet, *Renovate Right: Important Lead Hazard Information for Families, Child Care Providers, and Schools* or *Remodelar Correctamente: Guía de Prácticas Acreditadas Seguras para Trabajar con el Plomo para Remodelar Correctamente*. (EPA, 2011) See Appendix 6 for more information, including how to obtain the pamphlets.

If an activity meets the EPA's definition of abatement (40 CFR 745.223), whether or not the abatement activity is performed as part of a larger renovation project, it must be conducted by a certified abatement contractor in accordance with EPA's abatement regulations (40 CFR 745, subpart L) or, if the work is being done in an EPA-authorized state or tribal area, that jurisdiction's abatement regulation (issued under 40 CFR 745, subpart Q). Abatement is generally defined as any measure or set of measures designed to permanently eliminate lead-based paint hazards. For renovations in housing receiving HUD assistance, see the April 19, 2001, "HUD/EPA abatement letter," which clarified the requirements for rehabilitation and lead hazard reduction in property receiving up to \$25,000 per unit in Federal rehabilitation assistance under HUD's LSHR, and the definition of "abatement" under EPA and HUD regulations. (http://portal.hud.gov/hudportal/documents/huddoc?id=DOC_25480.pdf).

Housing renovation work that is performed for pay is regulated by OSHA, whose standard for lead in the construction industry requires protection for renovation workers. For example, if the work includes manual demolition, scraping, sanding, and/or the use of heat guns, needle guns, and power sanders on surfaces coated with paint that has lead in it, there are worker protection requirements involving air monitoring, respirators, medical surveillance, training, "engineering controls," and other protective measures (depending on the employee's potential for exposure). See Chapter 9 and Appendix 6 for more information.

A. Evidence of Lead Poisoning Caused by Improper Renovation

There is substantial evidence that uncontrolled housing renovation work can cause lead poisoning. One study found that refinishing activity performed in dwellings with lead-based paint was associated with an average 69 percent increase in the blood lead level of the 249 infants living there (Rabinowitz, 1985a) (see Figure 4.1). Another study of 370 lead poisoned children found a statistically significant association between household renovation activity and young children's blood lead levels at or above 10 µg/dL ($p < 0.0001$) (Shannon, 1992). Other researchers have also reported cases where renovation activity has resulted in EBLs (Fischbein, 1981; Marino, 1990). The costs of cleaning up a house contaminated by paint removal using uncontained power sanding can run as high as \$195,000 (Jacobs, 2003). EPA announced the availability of two new studies in its Renovation, Repair, and Painting (RRP) rulemaking docket on March 16, 2007 (<http://www.epa.gov/lead/pubs/rrp.htm>). Based on this data, the Agency concluded that renovation, repair, and painting activities that disturb lead-based paint create lead-based paint hazards.

II. Lead-based Paint Hazards in Housing Renovation

A. Similarities between Lead Hazard Control Work and Housing Renovation

Table 4.1 shows the similarity between lead hazard control work, that is, activities conducted for the purpose of reducing



FIGURE 4.1 Sanding wooden floors can generate significant amounts of dust.

current or anticipated lead hazards, and renovation activities. Many activities are common to lead hazard control and renovation work because they disturb known or presumed lead-based paint. For example, window replacement can be performed as part of a home renovation, but also could be done as an abatement project to address lead hazards. Whether a project is a renovation or lead hazard control often depends on the intent of the work. Lead hazard control jobs are intended to reduce or eliminate a specific lead hazard(s), while renovation work is not, even though it may coincidentally address lead hazards.

Table 4.1 Similarities between Lead Hazard Control and Renovation

Renovation Technique	Lead Hazard Control Technique
Repainting	Paint film stabilization
Window and door repair	Friction and impact surface treatments
Landscaping	Soil treatment
Installation of new building components (e.g., cabinet replacement)	Building component replacement
Paint stripping	On-site paint removal
New wall installation	Enclosure

B. Dust Containing Lead

It does not take much leaded dust to create a hazard. Almost any activity that involves disturbing a lead-containing surface will increase the amount of microscopic leaded dust in the surrounding environment, and may create a lead dust hazard when the dust settles on horizontal surfaces

To understand how easily a lead dust hazard can be created when disturbing lead-based paint, consider the following example. Suppose renovation work is done on only 1 square foot of painted surface and all the paint inside that square foot is turned into dust by sanding or some other work. If the paint has 1 mg/cm² of lead in it (the lowest lead concentration covered by EPA and HUD regulation) and if the dust is spread out over a 100 square foot area (the size of a 10 foot by 10 foot room), there will be about 9,300 µg/ft² of leaded dust present, which is over 200 times greater than the allowable level. HUD does not permit more than 40 µg/ft² of leaded dust to be left on

floors following lead hazard control work in HUD-assisted housing. In short, dust-generating work performed on even a small area can cause a serious problem if not controlled and cleaned up. Of course, working on a small area requires only modest cleaning and control measures, as described in Chapters 8 and 11.

C. Fumes

Whenever lead-based paint is heated above 1,100°F, some of the lead will vaporize. These small particles (fumes) are extremely dangerous because they can be inhaled and rapidly absorbed into the body. When these particles settle, they increase the amount of lead dust in the work area. These fumes are present whenever high-temperature heat guns or open flames heat the paint film excessively. Lead fumes can also be a problem when debris coated with lead-based paint is burned or metal coated with lead-based paint is welded (see Figure 4.2).

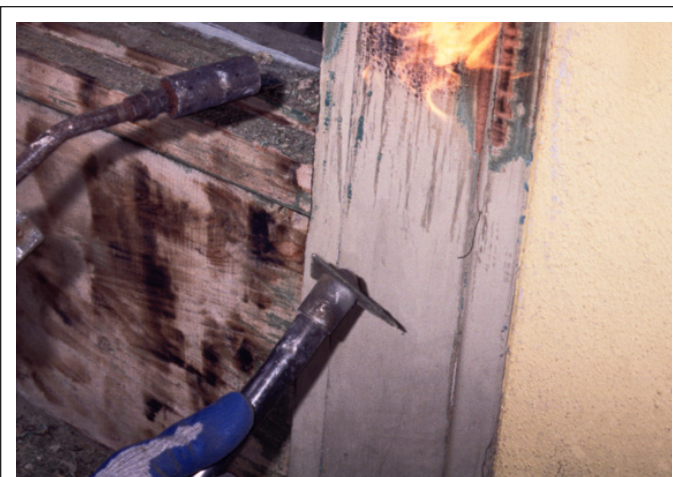


FIGURE 4.2 Torching and burning old paint is a prohibited work practice that can generate lead fumes.

D. Paint Chips

Metal brushing, dry scraping, or water blasting any lead-containing surface creates many poisonous chips that will contaminate the floor, window sills and troughs, and/or the ground, where they are accessible to children. These methods should not be used except in limited circumstances with appropriate controls (see Chapters 11 and 12). Waste and debris from a renovation should be handled properly (see Chapter 10).

E. Exposed Surfaces

Wooden surfaces that have had all lead-based paint removed may still have leaded particles trapped in the pores of the wood. While these surfaces are drying out and being prepared for repainting, they can cause lead poisoning if dust is generated, or if they are touched, mouthed, or chewed by small children. Repainting should always be completed before children are allowed back into the area.

F. Soil

For many years automobile gasoline exhaust contained lead that was deposited onto soil (Mielke, 2011). In 1973, 1985 and 1996, EPA issued standards that cut and then completed the phase-out of lead in gasoline (see the EPA press releases linked from <http://www.epa.gov/aboutepa/history/topics/lead/02.html>). Also, paint chips from previous paint scraping jobs and normal weathering of paint can contaminate the top few inches of soil around older dwellings. Excavation, landscaping, concrete flatwork, and re-grading that disturb lead-contaminated soil may also cause lead poisoning by increasing the accessibility of the soil to children and by making the soil more easily tracked into the dwelling.

III. Coordinating Renovation and Lead Hazard Control

Coordinating lead hazard control with renovation work will result in substantial savings when compared to the cost of conducting each activity independently. HUD's public housing program has been combining lead-based paint abatement with housing renovation for a number of years with considerable success and cost savings. Subpart J of HUD's Lead Safe Housing Rule requires evaluation and lead hazard control by qualified workers in properties constructed before 1978 as a condition of Federal rehabilitation assistance; the type of evaluation and control measures depend on the amount of assistance per housing unit (see Appendix 6). State and local governments have conducted lead hazard controls during restoration of privately-owned housing with the assistance from HUD's Lead Hazard Control Programs. As a result, a significant number of housing units have been treated with interim controls or abated.

A. Phasing projects

One way of coordinating lead hazard control and renovation is phasing. To do a project in phases, determine which parts of the job will disturb lead-based paint or produce contaminated dust, and which parts will not do so, such as work that is done after the lead-disturbing parts of the project are complete. A firm certified under EPA's (or an EPA-authorized state's or tribe's) RRP Rule must be used for performing paint-disturbing work unless the paint has been tested and found not to be lead-based paint. As noted above, if the work is abatement, only a firm certified by EPA (or an EPA-authorized state or tribe) can perform lead abatement activities. Once the lead disturbing work is complete and the area is cleared for reoccupancy, then the remainder of the job can be performed using traditional methods. In many cases, this means that the lead hazard control phase of the work will be completed before traditional renovation work during the initial demolition phase of the project. In other cases, a more complicated phasing process is necessary where abatement activities alternate with traditional construction work.

All cuts or penetrations into surfaces with lead-based paint (or paint that is presumed to be lead-based paint) that are needed to complete the job should be identified ahead of time so that they will be performed by the appropriate contractor (if multiple contractors are used) and so that cleanup, worker protection, and containment are employed at the appropriate times. For example, if new plumbing will require cutting into an existing wall containing lead-based paint, the certified RRP firm should do the cutting and cleaning. Alternatively, the plumber could do this work if appropriately certified.

Separate contractors are not always necessary when combining renovation and lead hazard control work. If the project does not involve abatement, all work could be completed by a renovation contractor certified by EPA (or the state), but where abatement is involved, the project would likely require both EPA certified abatement and renovation contractors. Chapter 3 contains additional information on how to plan lead-based paint abatement projects.

B. Concurrent renovation and lead hazard control

As seen in Table 4.1, Similarities between Lead Hazard Control and Renovation, above, many activities conducted for lead hazard control are the same as those conducted for renovations in general in pre-1978 housing, with addition of lead safety measures. As a result, planning for renovations for purposes other than lead safety, such as weatherization or rearrangements of rooms, may be done concurrently with lead hazard control work.

Window replacement done for the purpose of lead hazard control is abatement, but when a window is replaced as part of a renovation project (a project not designed to address lead hazards), it is an example how a renovation project can also reduce lead hazards. Common findings in risk assessments are old windows having deteriorated lead-based paint and high levels of leaded dust on window sills and window troughs. When the intent is renovation, a firm certified under EPA's (or a state's) RRP Rule prepares the work area for dust containment, removes the old window, disposes of it properly, and conducts cleaning and cleaning verification. The new window can then be installed in the traditional fashion as long as no other surfaces with lead-based paint will need to be disturbed during installation. See Chapter 11 for additional examples and discussion.

IV. Safe Renovation Procedures for Pre-1978 Homes

There are certain practices that are required as part of the standard operating procedure of most renovation or remodeling project in pre-1978 housing. These practices also apply to most pre-1978 child-occupied facilities. (See Appendix 6 for discussion of the exceptions.)

If lead-based paint or contaminated dust or soil is known or presumed to be present, there are six basic precautions that should be taken:

- ◆ Resident protection (see Chapter 8).
- ◆ Worker protection (see Chapter 9).
- ◆ Proper management of waste (see Chapter 10).
- ◆ Lead-safe work practices (see Chapter 11).
- ◆ Final cleaning techniques (see Chapter 14).
- ◆ Final clearance (see Chapter 15).

These are discussed in sequence in the following sections:

A. Pre-Work Planning

Renovation projects in pre-1978 housing should be planned in a manner that considers existing lead hazards and lead hazards that could be created by the renovation if the work is not done properly.

Testing can be done for paint, dust, and soil to determine if its lead content exceeds applicable standards. The tests can define the building components that can be handled in a traditional way and the building components that must be treated using lead-safe work practices. Field testing methods for lead in paint (paint testing) include portable X-ray fluorescence (XRF) lead paint analyzer, laboratory analysis of paint chips, or chemical test kits. For characterizing paint in federally-owned or -assisted housing, HUD requires use of an XRF or paint testing (paint chip sampling by a certified LBP inspector or risk assessor followed by analysis by an EPA-recognized paint lead laboratory), or presumption that lead-based paint is present.

Planning should also include decisions on how the project will be determined to be completed and the residents allowed to reoccupy the work area. The two main approaches for all but the smallest interior projects are cleaning verification and clearance. EPA permits the use of some spot tests kits

for certain characterizations of paint to be disturbed during RRP projects as part of its cleaning verification method. See EPA's website www.epa.gov/lead for information on the Agency's research activities on spot test kits, and on their use under the RRP Rule.

Clearance testing shows how much leaded surface dust is on various horizontal building components. Usually the floors and the interior window sills will be tested as part of a risk assessment (see Chapter 5). Window troughs will also be tested as part of clearance to determine if cleaning was adequate (see Chapters 14 and 15).

Exterior projects are determined to be completed based on visual inspection of the work area for the absence dust and debris.

B. Occupant Protection

1. Education

Residents who are not educated about the dangers of lead poisoning may revisit the home unexpectedly and compromise the containment measures, or allow their children to play in the worksite. Owners and residents who are educated about the potential dangers will become aware of the special protection and cleaning procedures that all renovation contractors and subcontractors must include in their general requirements when dealing with lead-based paint.

Before starting any renovation job in a home built before 1978, affected entities the owner and resident(s) must be informed of the dangers of lead-based paint. Similarly, before starting any renovation job in a child-occupied facility built before 1978, the property owner or facility owner, and the parents and guardians of children using the child-occupied facility must be informed of the dangers of lead-based paint.

Specifically, an EPA regulation requires contractors who perform renovation, repairs, and painting jobs in pre-1978 housing and child-occupied facilities, before beginning work, to provide housing owners and tenants, owners of child-care facilities, adult representatives of child care facilities, and the parents or guardians of children under age six who use the child-care facilities with a copy of the EPA lead hazard information pamphlet *Renovate Right* or *Remodelar Correctamente*. The electronic version of the pamphlet, in English and Spanish, is available on the EPA's and HUD's websites. (EPA, 2011) See Appendix 6 for more information.

2. Containment

EPA's RRP rule requires work area containment, as does HUD's LSHR for federally-assisted projects. For interior projects containment must be adequate to contain and prevent the spread of dust and debris beyond the work area. The following containment is required for interior projects:

- ◆ Post signs defining the work area
- ◆ Remove or cover all objects from/in the work area.
- ◆ Close and cover all ducts in the work area.
- ◆ Close all windows, and cover all doors in the work area.

- ◆ Cover the floor surface of the work area with plastic sheeting a minimum of 6 feet in all directions from where paint is disturbed.

For exterior projects, EPA's RRP rule requires containment be adequate to prevent dust and debris from leaving the work area; HUD's LSHR incorporates this requirement for federally-assisted projects. The following containment is required for exterior projects:

- ◆ Close all doors and windows within 20 feet of the renovation.
- ◆ Cover doors within the work area used for access with plastic sheeting in a manner that allows workers to pass through while confining dust and debris to the work area.
- ◆ Cover the ground with plastic sheeting extending 10 feet beyond the perimeter of surfaces undergoing renovation or a sufficient distance to collect falling paint debris.
- ◆ In certain situations, the renovation firm must take extra precautions in containing the work area to ensure that dust and debris from the renovation does not contaminate other buildings or other areas of the property or migrate to adjacent properties.

3. Relocation

One of the safest ways to prevent lead poisoning is temporary relocation of the residents and their "portable" belongings. With all of the small possessions out of the dwelling, there is relatively little to clean prior to reoccupancy (see Figure 4.4). Occupants should not return to the work area until cleanup and final painting or finishing have been completed and clearance has been achieved, or cleaning verification performed on renovations where clearance is not otherwise required prior to reoccupancy. For small jobs, relocation may not be necessary. For federally-assisted renovations, relocation is required for longer and more extensive projects. See Chapter 8 for further discussion of relocation techniques, and Appendix 6 for regulatory information.



FIGURE 4.3 This worksite was not properly prepared for lead-disturbing work by removing the occupant's belongings.



FIGURE 4.4 HEPA vacuuming is an important step in the specialized cleaning process.

C. Worker protection

Project planning must cover worker protection, whether the work is to be done by the property owner's or manager's staff or by outside contractors. The workers' employer is responsible for ensuring that workers doing the work are doing so in a safe and healthful manner. See Chapter 9 and Appendix 6 for further information.

The property owner or manager should include a requirement in staff standard operating procedures and in renovation contracts that OSHA (and other applicable) worker protection requirements are implemented.

D. Waste Disposal

EPA's RRP rule requires the following waste disposal requirements, as does HUD's LSHR for federally-assisted projects:

- ◆ Waste from renovation activities must be contained to prevent releases of dust and debris. If a chute is used to remove waste from the work area, it must be covered.
- ◆ Waste that has been collected from renovation activities must be contained.
- ◆ When transporting waste the firm must contain waste and prevent release of dust and debris.
- ◆ Note: The disposal of household waste is generally exempt from EPA regulation, but such waste should be carefully managed and disposed of in accordance with the recommendations in Chapter 10.

E. Cleaning Techniques

EPA's RRP rule requires the following cleaning procedure:

- ◆ Pick up paint chips and debris.
- ◆ Remove all protective sheeting.
- ◆ Clean all objects and surfaces in and around the work area.
 - Clean walls with a HEPA-equipped vacuum or with a damp cloth.
 - HEPA vacuum all remaining surfaces and objects in the work area.
 - Wipe all remaining surfaces in the work area with a damp cloth.
 - Mop uncarpeted floors.

To be most effective, vacuums should be used in combination with wet cleaning with detergents and clean rinse. The cleaning process starts with a vacuuming, followed by wet cleaning and a final vacuuming. Research on methods for removing lead-contaminated dust from wood surfaces found that vacuuming and wet wiping, the traditional method, was somewhat more effective than two newer (electrostatic dry cloth, and wet Swiffer-brand mop) methods (Lewis, 2012). The wipe product industry continues to develop products; future cloths may have higher dust reduction efficiencies. See Chapter 14 for more details about cleaning techniques.

F. Clearance Testing

If work is being done in federally assisted pre-1978 housing, dust wipe clearance testing is required instead of cleaning verification. Clearance testing may also be required under the renovation contract. When clearance testing is used, the area is ready for reoccupancy only after visual inspection of the project and laboratory analysis of dust wipe samples show that no lead hazards remain. See Chapter 15 and Appendix 6.

V. Prohibited Activities

Many traditional methods of preparing a painted surface for repainting, refinishing, or re-staining are prohibited if the old paint contains lead, since these methods are known to poison both children and workers. Chapter 11 discusses safe ways of removing lead-based paint.

Methods of paint removal prohibited by EPA's RRP and abatement regulations:

- ◆ Open-flame burning or torching of painted surfaces.
- ◆ The use of machines (such as abrasive blasters and sandblasters) designed to remove paint or other surface coatings is prohibited unless the machine has a shroud or containment systems and is equipped with a HEPA vacuum attachment to collect dust and debris at the point of generation.
- ◆ Operating a heat gun on painted surfaces above 1,100 degrees Fahrenheit.

Additional methods of paint removal prohibited by HUD's Lead Safe Housing Rule:

- ◆ Manual dry sanding (except within 1 foot of electrical outlets).
- ◆ Heat guns that char paint.
- ◆ Paint stripping in a poorly ventilated space when using a volatile stripper.

OSHA's Lead in Construction standard prohibits the use of compressed air to remove lead from any surface unless used in conjunction with a ventilation system designed to capture the airborne dust created by the compressed air.

These *Guidelines* recommend strongly against the use of uncontained hydroblasting. Removal of paint using this method can spread paint chips, dust, and debris beyond the work area containment. Contained pressure washing can be done within a protective enclosure to prevent the spread of paint chips, dust, and debris. Water runoff should also be contained (see Chapter 8). (See Chapters 11 and 12).

VI. Housing Receiving Federal Rehabilitation Assistance

The HUD Lead Safe Housing Rule established procedures for federally funded rehabilitation activities (24 CFR Part 35, Subpart J; <http://www.hud.gov/offices/lead/enforcement/lshr.cfm>). Additional information on lead-safe rehabilitation is available in the training curriculum, "Making It Work: Implementing the Lead Safe Housing Rule in CPD-Funded Programs" on HUD's website at: http://www.hud.gov/offices/lead/training/training_curricula.cfm (see Modules 3 and 4). Contractors are not always familiar with the funding source of their projects. It is important for all parties involved to become familiar with

the funding source in order to ensure proper lead-based paint regulatory compliance. Multiple laws and regulations can apply, and not all have the same requirements. In general, where there are overlapping requirements, the most protective apply.

A. Options

When undertaking federally assisted rehabilitation, the property owner may either presume that all painted surfaces are coated with lead-based paint or arrange for paint testing of surfaces to be disturbed during rehabilitation by a licensed lead-based paint inspector or risk assessor using either XRF instrumentation or by a licensed lead-based paint inspector or risk assessor submitting paint samples to an NLLAP-recognized laboratory, as noted above. **HUD does not allow certified renovators to perform paint testing on surfaces to be disturbed to meet the paint testing or presumption requirement for a federally funded rehabilitation project unless they are also certified inspectors or risk assessors (LSHR, at 24 CFR 35.1320(a)).**

B. Notices and Pamphlets

In cases where evaluation or hazard reduction or both are undertaken, the property owner shall provide notices of evaluation and of hazard reduction activity to occupants in accordance with the Lead Safe Housing Rule. The property owner must also provide to each occupied dwelling unit a copy of the EPA lead hazard information pamphlet, [Renovate Right](#) or [Remodelar Correctamente](#), in accordance with HUD's Lead Safe Housing Rule and EPA's Renovation, Repair, and Painting (RRP) Rule.

C. Evaluation and Hazard Reduction Requirements for Rehabilitation Activities covered under the Lead Safe Housing Rule

The requirements for rehabilitation (and the associated level of lead hazard control) depend on the hard costs of the rehabilitation project, as calculated on a per-housing unit basis in accordance with the provisions of Section 35.915, and the amount of Federal assistance per unit. For projects receiving Federal rehabilitation assistance:

- ◆ Using lead-safe work practices is required for projects with hard costs up to \$5,000 per unit;
- ◆ Interim controls, for projects with hard costs above \$5,000 and up to \$25,000 per unit; and
- ◆ Abatement, for projects with hard costs above \$25,000 per unit.

See Appendix 6 for more information on subpart J, Rehabilitation, of HUD's Lead Safe Housing Rule.

References

- EPA, 2011. U.S. Environmental Protection Agency, "Reducing Steps to Lead Safe Renovation, Repair and Painting,," (EPA 740-K-11-001) October 2011.
- EPA, 2011. U.S. Environmental Protection Agency, "Small Entity Compliance Guide to Renovate Right: A Handbook for Contractors, Property Managers and Maintenance Personnel Working in Homes, Child Care Facilities and Schools Built Before 1978." (EPA-740-K-10-003, Revised September 2011).
- EPA, 2011. "[Renovate Right: Important Lead Hazard Information for Families, Child Care Providers, and Schools](http://www.epa.gov/lead/pubs/renovaterightbrochure.pdf)," on EPA's website at <http://www.epa.gov/lead/pubs/renovaterightbrochure.pdf>, in English, and, in Spanish, at <http://www.epa.gov/lead/pubs/renovaterightbrochuresp.pdf>. Also available on HUD's website at <http://www.hud.gov/offices/lead/library/lead/renovaterightbrochure.pdf> in English, and, in Spanish, at <http://www.hud.gov/offices/lead/library/lead/renovaterightbrochuresp.pdf>.
- Fischbein, 1981. Fischbein, A., K.E. Anderson, S. Shigeru, R. Lilis, S. Kon, L. Sarkoi, and A. Kappas, "Lead Poisoning From Do-It-Yourself Heat Guns for Removing Lead-Based Paint: Report of Two Cases," *Environmental Research* 24: 425–431.
- Jacobs, 2003. Jacobs, D.E., H. Mielke and N. Pavur, "The High Cost of Improper Removal of Lead-Based Paint from Housing: A Case Report," *Environmental Health Perspectives* 111 (2): 185-6.
- Lewis, 2012. Lewis R.D., Ong, K.H., Emo, B, Kennedy, J., Brown, C.A., Condoor, S. and Thummalakunta, L, Do New Wipe Materials Outperform Traditional Lead Dust Cleaning Methods? *Journal of Occupational and Environmental Hygiene*, 9:8 524-533, August 2012. <http://www.tandfonline.com/doi/abs/10.1080/15459624.2012.695975>
- Marino, 1990. Marino, P.E., P.J. Landrigan, J. Graef, A. Nussbaum, G. Bayan, K. Boch, and S. Boch, "A Case Report of Lead Paint Poisoning During Renovation of a Victorian Farmhouse," *American Journal of Public Health*, 80(10): 1183–1185.
- Mielke, 2011. Mielke, H.W., M.A. Laidlaw, and C.R. Gonzales, Estimation of leaded (Pb) gasoline's continuing material and health impacts on 90 US urbanized areas. *Environment International*, 37(1):248-57. <http://www.ncbi.nlm.nih.gov/pubmed/20825992>
- Rabinowitz, 1985a. Rabinowitz, M., A. Leviton, and D. Bellinger, "Home Refinishing, Lead Paint, and Infant Blood Lead Levels," *American Journal of Public Health* 75(4): 403–404.
- Shannon, 1992. Shannon, M.W., and J.W. Graef, "Lead Intoxication in Infancy," *Pediatrics* 89(1): 87–90.
- OSHA, 2003, "Lead in Construction," OSHA 3142-09R.

Chapter 5: Risk Assessment and Reevaluation

STEP-BY-STEP SUMMARY

LEAD-BASED PAINT RISK ASSESSMENT: HOW TO DO IT	5-7
I. Introduction	5-9
A. Evaluation Options	5-9
1. Risk Assessment	5-11
2. Lead Hazard Screen	5-11
3. Lead-Based Paint Inspection	5-13
4. Combination Risk Assessment and Lead-Based Paint Inspection	5-13
5. Selective Testing	5-13
6. Bypassing Evaluation, and the Option to Presume	5-14
B. The Risk Assessment Process	5-17
C. Limitations of This Risk Assessment Protocol	5-17
1. Risk Assessments of Dwellings Housing Children with Elevated Blood Lead Levels	5-17
2. Assessment of Less Common Sources of Lead Exposure	5-18
D. Non-Federal Standards	5-19
II. Data Collection	5-19
A. Questionnaires	5-19
1. Individual Occupied Units (Form 5.0)	5-19
2. Multi-family Rental Properties (Form 5.6)	5-20
B. Floor Plan and Site Plan Sketches	5-20
C. Building Condition Inspection (Form 5.1)	5-20
D. Visual Assessment	5-21
1. Overall Scope and Purpose	5-21
2. Documentation of Locations	5-22
3. Identification of Deteriorated Paint (Form 5.2)	5-24
4. Identification of Friction Surfaces (Form 5.2)	5-28
5. Identification of Impact Surfaces (Form 5.2)	5-31
6. Identification of Chewable Surfaces (Form 5.2)	5-32
7. Identification of Bare Soil (Form 5.5)	5-33
E. Dust Sampling	5-35
1. Method of Sample Collection	5-35
2. Selection of Rooms within a Dwelling Unit	5-38
3. Selection of Locations within Rooms	5-40
4. Composite Dust Sampling	5-45
5. Common Areas (Multi-family Housing Only)	5-47
6. On-site Dust Analysis	5-48
F. Paint Testing in Risk Assessment	5-49

1. Evaluating Previous Paint Testing	5-49
2. Paint Testing Methods	5-51
3. Surfaces to Be Tested	5-52
4. Field Report of Paint Testing	5-54
G. Soil Sampling	5-54
1. Sample Locations	5-54
2. Sample Collection Method	5-55
3. Number of Samples	5-56
4. Field Report	5-59
H. Water Sampling (Optional)	5-59
I. Lead Hazard Screen Protocol	5-60
1. Questionnaire	5-60
2. Building Condition	5-60
3. Floor-Plan Sketch (Optional)	5-60
4. Visual Assessment	5-60
5. Dust Testing	5-61
6. Paint Testing	5-61
7. Soil Testing	5-61
8. Interpretation of Testing Results	5-61
9. Report	5-61
III. Risk Assessments for Evaluations of Different Size	5-62
A. Risk Assessments for Owner-Occupied, Single-Family Dwellings	5-64
B. Risk Assessments for Five or More Similar Dwellings	5-64
1. Targeted, Worst Case, and Random Sampling	5-65
C. Risk Assessments of Fewer Than Five Rental Dwellings and Multiple Dwellings That Are Not Similar	5-67
1. Assessments of Five or More Dwellings That Are Not Similar	5-68
2. Assessments of Fewer Than Five Similar Dwellings	5-69
D. Analysis of Management and Maintenance Practices (Optional)	5-69
IV. Laboratory Analytical Procedures	5-69
V. Evaluation of Findings	5-70
A. Interpreting Results of Environmental Testing	5-70
1. Dust	5-70
2. Paint	5-76
3. Bare Soil	5-76
4. Hazard Evaluation by Targeted, Worst-Case, or Random Sampling	5-79
5. Water (Optional)	5-80
6. Other Lead Sources (Optional)	5-81
B. Evaluating Management Policies (Optional)	5-81
C. Maintenance of Multiple Dwellings (Optional)	5-84

D. Lead Hazard Screen in Dwellings in Good Condition 5-84

VI. Risk Assessment Report 5-84

 A. Site-Specific Hazard Control Options 5-85

 1. Control Measures 5-85

 2. Education 5-86

 B. Cost and Feasibility 5-88

 1. Cost 5-88

 2. Feasibility 5-88

 C. Reevaluation Recommendation 5-89

 D. Recommendations to Owners When No Hazards Are Identified 5-89

 E. Report Format 5-89

 1. Executive Summary 5-89

 2. Table of Contents 5-90

 3. Identifying Information and Risk Assessor’s Signature (EPA-required) 5-90

 4. Purpose of This Risk Assessment 5-90

 5. Definitions 5-91

 6. Description of Lead-Based Paint Hazards and Acceptable Hazard Control Options (EPA-required) 5-92

 7. Recommendations for Maintenance and Monitoring (EPA-required) 5-93

 8. Additional Recommendations for Management (optional) 5-93

 9. Supporting Information (EPA-required) 5-93

VII. Reevaluation 5-94

 A. Purpose and Applicable Properties 5-94

 B. Reevaluation Schedule 5-95

 C. Reevaluation Protocol 5-96

 1. Review of Prior Reports 5-96

 2. Visual Assessment 5-97

 3. Dust Sampling 5-97

 4. Testing Deteriorated Paint and Bare Soil for Lead 5-97

 5. Reevaluation Report 5-98

 6. Sampling in Multi-family Dwellings 5-98

REFERENCES 5-113

FIGURES

Figure 5.1 Lead Hazard Screen Decision Logic 5-12

Figure 5.2 Risk Assessor interviewing a resident..... 5-20

Figure 5.3 Record of sampling locations and floor plan sketch 5-21

Figure 5.4 Forms of Paint Deterioration 5-25

Figure 5.4a	Peeling paint	5-25
Figure 5.4b	Alligating paint.....	5-25
Figure 5.4c	Blistering paint	5-25
Figure 5.5	Baseboard showing deteriorated paint less than the de minimis amounts.....	5-28
Figure 5.6a	Friction hazard on stairs pre-treatment	5-30
Figure 5.6b	Friction hazard on stairs post-treatment	5-30
Figure 5.7	Impact surface on door and frame	5-31
Figure 5.8	Chewable surface showing teeth marks on window sill	5-32
Figure 5.9	Soil lead hazard at dripline	5-32
Figure 5.10	Soil lead hazard at dripline of garage	5-34
Figure 5.11a	Dust sampling equipment	5-37
Figure 5.11b	Pulling a wipe from container.....	5-37
Figure 5.11c	Making first (horizontal) pass of clearance wipe.....	5-37
Figure 5.11d	Folding wipe.....	5-37
Figure 5.11e	The second (vertical) pass.....	5-37
Figure 5.11f	Placing the used wipe into hard container.....	5-37
Figure 5.12	Floor sampling in high traffic area near entry.....	5-39
Figure 5.13	Window sill and trough.....	5-40
Figure 5.14	Illustrations of window trough and interior window sill.....	5-41
Figure 5.15	Example of basic dust sampling plan	5-43
Figure 5.16	Dust testing window sill for presence of friction hazard	5-44
Figure 5.17	Damage to painted surface caused by paint chip sampling	5-52
Figure 5.18	Baby's bed exhibiting deteriorated paint and evidence of teeth marks.....	5-53
Figure 5.19a-c	Soil sampling.....	5-55
Figure 5.20	Example of targeted dwelling selection.....	5-74
Figure 5.21	Example of soil hazard determination in non-play areas.....	5-78
Figure 5.22	Example of lead hazard control policy	5-83

TABLES

Table 5.1	Comparison of Risk Assessment, Lead Hazard Screen, Lead-Based Paint Inspection, and Combination Inspection/Risk Assessment	5-10
Table 5.2	Percentage of Housing Units with Significant Lead-Based Paint Hazards, and Percentage with Bare Soil Lead Levels in Yard \geq 1200 ppm, United States, 2005-2006	5-14
Table 5.3	Percentage of Component Types Coated with Lead-Based Paint, by Year of Construction, and by Interior or Exterior Location, United States, 2000	5-16

Table 5.4	Illustrative List of Painted Components*	5-27
Table 5.5	Review of Previous Lead-Based Paint Inspections	5-50
Table 5.6	Recommended Number of Play Areas To Be Sampled.....	5-57
Table 5.7	Recommended Number of Non-play Areas of Dripline/Foundation Areas.....	5-58
Table 5.8	Recommended Number of Soil Samples in Non-play Areas of the Rest of the Yard Outside of Dripline/Foundation Areas	5-59
Table 5.9	Risk Assessment Approach for Evaluations of Different Size.....	5-63
Table 5.10	Minimum Number of Targeted Dwellings to Be Sampled Among Similar Dwellings (random sampling may require additional units)	5-68
Table 5.11	Federal Hazard Levels for Lead Hazard Risk Assessments*	5-73
Table 5.12	Main Hazard Control Options That Could Be Identified in Risk Assessments Based on Actual Conditions	5-87
Table 5.13	Paint-Lead Hazards.....	5-92
Table 5.14	Soil-Lead Hazards	5-92
Table 5.15	Dust-Lead Hazards	5-93

FORMS

Form 5.0	Questionnaire for a Lead Hazard Risk Assessment of an Individual Occupied Dwelling Unit.....	5-99
Form 5.1	Building Condition Form for Lead Hazard Risk Assessment.....	5-101
Form 5.2	Field Report of Visual Assessment for Lead Hazard Risk Assessment	5-102
Form 5.3	Field Paint Chip Sampling Form.....	5-103
Form 5.4a	Field Sampling Form for Dust. (Single-Surface Sampling)	5-104
Form 5.4b	Field Sampling Form for Dust. (Composite Sampling).....	5-105
Form 5.5	Field Sampling Form for Soil.....	5-106
Form 5.6	Questionnaire for a Lead Hazard Risk Assessment of More Than Four Rental Dwelling Units	5-107
Form 5.7	Format for an Executive Summary of a Lead Hazard Risk Assessment.....	5-111

Intentionally Left Blank

Chapter 5: Risk Assessment and Reevaluation

Step-by-Step Summary

Lead-Based Paint Risk Assessment: How To Do It

- 1. Determine scope.** Determine if the client is requesting a risk assessment, a lead-based paint inspection, or a combination of the two. Reach an agreement on costs and scope of effort. If the cause of a child having an elevated blood lead level is being investigated, use the protocol in Chapter 16 and coordinate with the local health agency. If the dwelling is in good condition (as defined by Form 5.1 in this chapter), a lead hazard screen may be conducted to determine if a full risk assessment is needed. If a previous risk assessment has been conducted, determine if the owner is requesting a reevaluation or a risk assessment. (If the housing is receiving HUD assistance, determine if the previous risk assessment is still current (i.e., conducted within the past 12 months) or has expired.) In all other cases, conduct a full risk assessment, a lead-based paint inspection, or a combination of the two. Neither air nor water samples are part of routine lead-based paint risk assessments or lead hazard screens.
- 2. Interview residents and/or owners.** For individual residences, interview residents about use patterns of young children (if any) and the family. For multi-family rental properties, the risk assessor asks the owner (or owner's agent) to submit information on the type and condition of the buildings to the risk assessor on forms provided by the risk assessor, or the risk assessor completes forms based on an interview of the owner (or owner's agent).
- 3. Survey building condition.** Perform a brief building condition survey to identify any major deficiencies that may affect the success of lead hazard controls and/or to determine whether a lead hazard screen may be an acceptable alternative to a full risk assessment.
- 4. Determine whether units will be sampled and, if so, select units.** Visual assessments and environmental sampling should be conducted in *each* dwelling if assessing individual dwelling units, fewer than five rental units, or multiple rental units where the units are not similar. If there are five or more similar dwellings, select the targeted, worst-case or randomly selected dwellings for sampling using the criteria in this chapter (see Section III.B and table 5.9) and then evaluation.
- 5. Conduct visual assessment.** Perform a visual assessment of the building and paint condition, using the forms and protocols in this chapter, and select dust sampling and paint testing locations based on use patterns and visual observations. Also identify bare soil in play areas and other parts of the yard and select locations for soil sampling.
- 6. Conduct dust sampling.**
 - ◆ In individual dwelling units, dust samples are typically collected in the entryway (if the dwelling unit has direct access to the outdoors) and at least four living areas where children under age 6 are most likely to come into contact with dust (such as the kitchen, the children's principal playroom, and children's bedrooms). One floor sample and one interior window sill sample (if a window is present) should be collected in each of the rooms or areas selected for dust sampling in dwelling units. Collect a floor sample at the entryway with immediate access to the outdoors.

- ◆ In multi-family properties, dust samples are also collected from the common areas, including main entryway, stairways and hallways, and other common areas frequented by a young child. In each selected common-area room or space, a floor sample should be collected and an interior window sill sample should be collected as well if there is a frequently used window present.
 - ◆ Submit dust samples to a laboratory recognized for the analysis of lead in dust by the U.S. Environmental Protection Agency (EPA) through the National Lead Laboratory Accreditation Program (NLLAP) (<http://www.epa.gov/lead/pubs/nllap.htm>) (See Appendix 6).
7. **Conduct soil sampling.** Collect a composite soil sample from bare soil in each of the three following area types: (a) each play area with bare soil, (b) non-play areas in the dripline/foundation area, and (c) non-play areas in the rest of the yard, (including gardens). Collect one composite sample from each distinguishable play area with bare soil, up to at least the number of sampled recommended in Section II.G of this chapter. Select the play areas used by young children, i.e., those under 6 years old. For non-play areas, collect a composite sample from bare soil (if present) in both the dripline/foundation area and the rest of the yard, following guidance in Section II.G. If the total surface area of bare spots in non-play areas is no more than 1 square yard (9 sq. ft.) for each property, the risk assessor may conclude that a lead-based paint hazard does not exist in non-play areas, and soil samples are not necessary (unless the soil sampling is required by State or local regulations). Bare soil of any size in play areas should always be sampled. Submit samples to an laboratory recognized by NLLAP for analysis of lead in soil.
 8. **Conduct paint testing as needed.** Conduct testing of deteriorated paint and intact paint on friction surfaces. Lead in deteriorated paint can be measured with a portable x-ray fluorescence (XRF) analyzer if there is a large enough flat surface with all layers present. If not, it is necessary to collect a paint sample by collecting all layers of paint (not just the peeling layers) and to submit the sample to a laboratory recognized by NLLAP for analysis of lead in paint.
 9. **Sample tap water (optional).** At the client's request, collect optional water samples to evaluate lead exposures that can be corrected by the owner (leaded service lines, fixtures). Water sampling is not recommended for routine risk assessments of lead-based paint hazards, since drinking water hazards are outside the scope of lead-based paint hazards and EPA has another program in this area. EPA has a protocol, including specific sample collection procedures and when to collect the samples, which should be followed; see Section II.H.) If a lead-contaminated water problem exists beyond the owner's service line, the local water supplier should be notified.
 10. **Interpret the laboratory results.** Interpret the results of the environmental testing in accordance with applicable regulations. (See Section V.A.)
 11. **Analyze data and discuss with client.** Integrate the laboratory results with the visual assessment results, any XRF measurements, and other maintenance and management data to determine the presence or absence of lead-based paint hazards, as defined under applicable statutes or regulations.
 12. **Prepare report.** Prepare a report listing any hazards identified and acceptable control measures, including interim control and abatement options.
 13. **Discuss** all the various safe and effective lead hazard control options, and provide recommendations, for specific lead hazards with the owner. If the risk assessment is being conducted in anticipation of an abatement, rehabilitation, renovation, repair or other project to be conducted, discuss how lead safety, including addressing the lead-based paint hazards identified in the risk assessment report, should be integrated into the project design and execution. (See chapters 10 through 15.)

I. Introduction

This chapter describes a procedure, known as a risk assessment, for determining the existence, nature, severity and location of lead-based paint hazards in or on a residential property and for reporting the findings of the assessment and the options for controlling or abating the hazards that are found. A risk assessment may be conducted in any residential property, regardless of occupancy. However, in the case of an environmental investigation of the home of a child with an elevated blood-lead level (EBL), the standard risk assessment described in this chapter should be supplemented with additional questions and activities. Please refer to Chapter 16 for guidance on additional information to be collected during an EBL investigation.

Activities that are required by EPA or HUD regulations are identified in this chapter as being “required” or as actions that “must” be done. Activities that are not required by EPA or HUD regulations but are recommended by these *Guidelines* are identified as being “recommended” or as actions that “should” be done. Note that there may be State, Tribal or local laws and regulations that have to be followed, especially if they are more stringent or protective than the federal requirements. Activities that may be done at the discretion of the owner or manager are identified as “optional.”

A. Evaluation Options

While most of this chapter is devoted to risk assessment protocols, this section offers owners, planners, and risk assessors guidance on choosing the most appropriate evaluation method for specific housing situations. Except where regulations specifically require a risk assessment or a lead-based paint inspection, there are no simple rules for choosing an evaluation method.

A property owner has a choice of the following evaluation options, except where regulations limit or determine the choice:

1. A risk assessment, which identifies lead-based paint *hazards*, as defined by EPA regulations.
2. A lead hazard screen (for properties in good physical condition).
3. A lead-based paint inspection, which identifies all lead-based paint, whether hazardous or not.
4. A combination risk assessment/paint inspection, which provides complete information on lead-based paint and lead-based paint hazards.
5. Testing of selected paint surfaces that may be lead-based paint hazards or that may be disturbed by repainting or other maintenance, renovation or rehabilitation activity.
6. Presumption; no hazard evaluation is performed. Proceed directly to control of presumed hazards, e.g., presume all deteriorated paint is a lead-based paint hazard.
7. Investigation of a home with an EBL child.

Table 5.1 provides an overview comparing these evaluation options.

Table 5.1 Comparison of Risk Assessment, Lead Hazard Screen, Lead-Based Paint Inspection, and Combination Inspection/Risk Assessment.

Analysis, Content, or Use	Risk Assessment	Lead Hazard Screen	Lead-Based Paint Inspection	Combination Inspection/ Risk Assessment
Paint	Deteriorated paint and intact paint on friction and impact surfaces only*	Deteriorated paint only	Surface-by-surface (all paint surfaces, including deteriorated paint)	Surface-by-surface (all paint surfaces, including deteriorated paint)
Dust	Yes	Yes	No	Yes
Soil	Yes	No	No	Yes
Water	Optional	No	No	Optional
Air	No	No	No	No
Maintenance status	Optional	No	No	Optional
Management plan	Optional	No	No	Optional
Status of any current child lead-poisoning cases	If information is available	If information is available	No	If information is available
Review of previous paint testing	Yes	Yes	Yes	Yes
Typical applications	<ol style="list-style-type: none"> 1. Interim controls 2. Building nearing the end of expected life 3. Sale of property or turnover 4. Insurance (documentation of lead-safe status) 5. Remodeling and Repainting 6. Lead Safe Housing Rule compliance 	Post-1960 housing in good condition for which a risk assessment is required or recommended	<ol style="list-style-type: none"> 1. Abatement 2. Renovation work 3. Weatherization 4. Sale of property or turnover 	Renovation work
Final Report	Location of lead-based paint hazards and options for acceptable hazard control methods, or certification that no lead-based paint hazards were found.	Probable existence of lead-based paint hazards (based on more stringent standards used for screen), or the absence of lead-based paint hazards.	Lead concentrations for each painted building component or certification that no lead-based paint was found.	Combination of risk assessment and inspection report content.

* For pre-rehabilitation risk assessments in housing not receiving HUD rehabilitation assistance, assess the paint to be disturbed. If the target housing is receiving HUD rehabilitation assistance up to \$5,000 per unit, conduct paint testing of the paint to be disturbed. If the assistance is over \$5,000 per unit, conduct a risk assessment of the entire property.

1. Risk Assessment

Risk assessments are on-site investigations to determine the existence, nature, severity, and location of lead-based paint hazards accompanied by a report explaining the results and options for reducing lead-based paint hazards (40 CFR 745.227(d)(11)) (see Appendix 6). A lead-based paint hazard is any condition that causes exposure to lead from dust-lead hazards, soil-lead hazards, or lead-based paint that is deteriorated, or present in chewable surfaces, friction surfaces, or impact surfaces that would result in adverse human health effects. Risk assessments can be performed only by risk assessors certified or licensed by EPA or an EPA-authorized State, Tribe or Territory.

A risk assessment report must cover the following, at a minimum:

- ◆ Identification of the existence, nature, severity, source, and location of lead-based paint hazards, including soil and dust hazards as well as paint (or documentation that no such hazards have been identified).
- ◆ Description of the options for controlling lead hazards in the event that hazards are found, including interim controls and abatement measures.

In addition, a risk assessor may provide other information, such as:

- ◆ Suggestions on how to keep in a non-hazardous condition lead-based paint that will remain in a dwelling after present hazards are corrected.
- ◆ Recommended changes to the management and maintenance systems. By considering all hazards and examining resident and owner practices, a risk assessor can determine appropriate ways to control hazards and modify management practices so that the chance of hazards recurring is reduced.
- ◆ If the housing is HUD-assisted, that HUD considers a risk assessment of the housing to be valid for 12 months (see 24 CFR 35.165(b)(1)).

These and other practices are described in this chapter.

2. Lead Hazard Screen

A second type of lead-based paint evaluation is the lead hazard screen. This evaluation method identifies lead-based paint hazards; it also identifies other potential lead hazards. It is an abbreviated form of evaluation and generally is available at a lower cost than a full risk assessment. However, this method should be used only in dwellings in good condition where the probability of finding lead-based paint hazards is low. A screen employs limited sampling (soil sampling is usually not conducted) and, as a trade-off, more sensitive hazard identification criteria. The protocol for a lead hazard screen is described later in this chapter. If a screen indicates that lead hazards may be present, the owner should have a full risk assessment performed. All lead hazard screens must be performed by risk assessors certified or licensed by EPA or an EPA-authorized state, tribe, or territory. If an owner is being charged travel time by the risk assessor, the lead

hazard screen may not be cost-effective if the property condition or date of construction indicates a full risk assessment is likely to have to be performed ultimately.

A lead hazard screen is likely to be less costly than a full risk assessment in housing in good condition built after 1960. As shown in Table 5.2, only 11 percent of the U.S. housing built between 1960 and 1977 is estimated to have “significant” lead-based paint hazards (any dust, soil and paint lead hazard, except deteriorated lead-based paint in amounts less than the “de minimis” amount described in Section II.D.3, below). This is compared to 39 percent for housing built in the period 1940-1959 and 67 percent for units built before 1940. It should be noted, however, that these statistics are based on the EPA dust-lead hazard standards of 40 µg/ft² for floors and 250 µg/ft² for interior window sills as of the publication of this edition of these *Guidelines*. The dust-lead standards are approximately *one-half* these values for a lead hazard screen (a more stringent evaluation criteria to act as a “negative screen”). Therefore, the probability that a home from the 1960-1977 period will be positive with a screen (i.e., that it will “fail” the screen) is greater than 11 percent. For example, while about 2.0% of housing units in this period have floor dust-lead hazards, i.e., lead levels of at least 40 µg/ft², about 2.4%, a higher percentage, would fail the lower floor dust-lead screen criterion of lead levels of at least 25 µg/ft². (HUD, 2011, based on table 6-4.) Similarly, for housing of all years, while about 4.9% of housing has floor dust-lead hazards, about 6.5%, also a higher percentage, would fail the floor dust-lead screen criterion. (HUD, 2011, based on table 6-2). The impact of the more stringent screen standards on screen failure rates may be small if the housing is in good condition.

Lead hazard screens should not be used in buildings in poor condition, since a full risk assessment will usually be needed. This is especially true of structures built before 1960. A suggested decision-making process to determine whether the lead hazard screen option is appropriate is outlined in Figure 5.1.

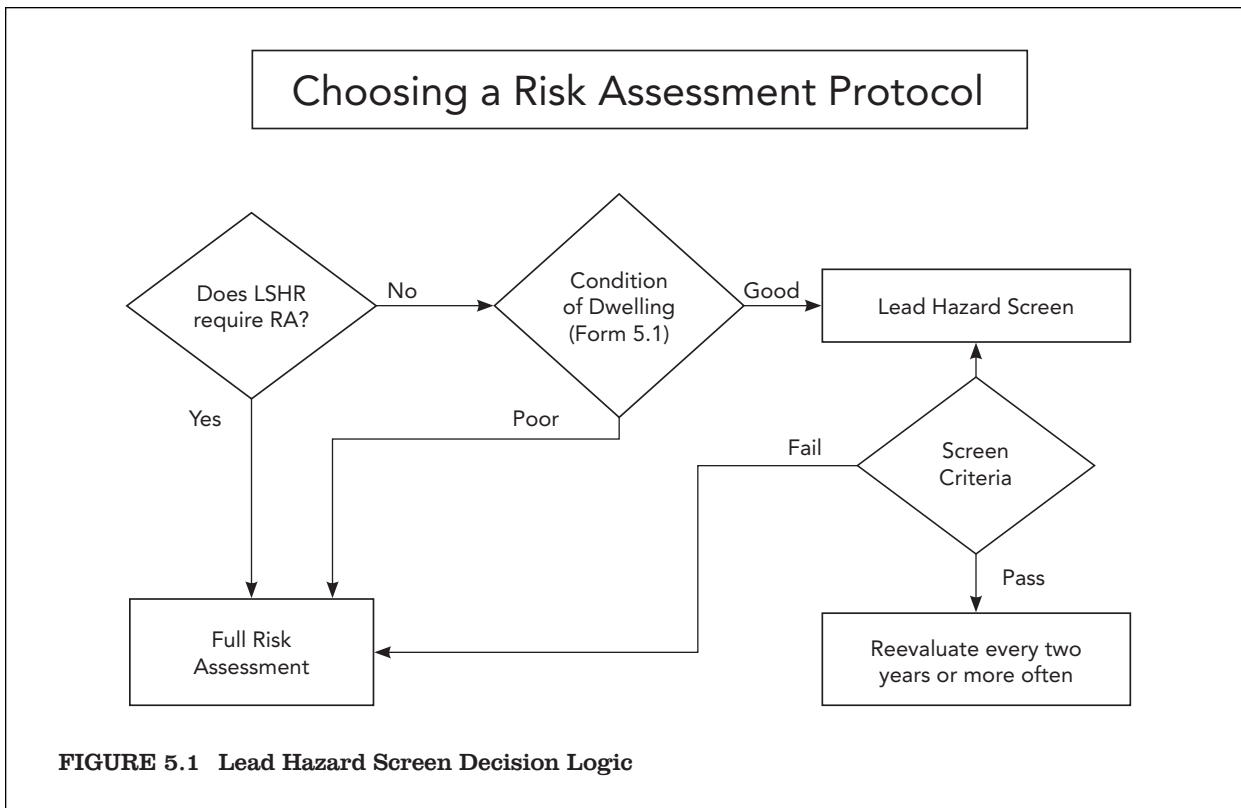


FIGURE 5.1 Lead Hazard Screen Decision Logic

3. Lead-Based Paint Inspection

Lead-based paint inspections measure the concentration of lead in paint on a surface-by-surface basis. Inspection results enable the owner to manage *all* lead-based paint, since the exact locations of the lead-based paint have been identified. A lead-based paint inspection (covered in Chapter 7) must be performed by a lead-based paint inspector certified or licensed by EPA or an EPA-authorized state, tribe or Territory. In many states, a certified risk assessor is also qualified to perform a lead-based paint inspection. (Note that the paint testing described below in Section I.A.5 is a technique involving only a limited number of surfaces for use in planning maintenance or similar projects, and is not a comprehensive lead-based paint inspection.)

A lead-based paint inspection identifies only the presence of lead-based paint; it does not determine whether the paint presents an immediate hazard. Also, the collection of dust and soil samples is not part of a lead-based paint inspection. Thus, if a risk assessment is not performed along with the paint inspection, a full determination of the location and nature of all lead-based paint hazards (including dust and soil hazards) cannot be made.

Without data about hazards, a lead-based paint inspector cannot offer guidance on lead hazard control, including appropriate lead hazard control measures. A lead-based paint inspector does not necessarily have the training to identify all hazard control options, while a risk assessor does.

Nevertheless, a lead-based paint inspection is the preferred evaluation method when an owner has decided to abate all lead-based paint. Because abatement activities can be costly, it is usually cost effective to complete a lead-based paint inspection before using resources to abate presumed hazards. Inspections are also appropriate when extensive renovation that is about to occur will disturb painted surfaces. An owner may also choose to have a lead-based paint inspection performed to obtain a regulatory exemption that would apply if the property is found to have no lead-based paint. Table 5.1 provides a summary comparison of evaluation methods.

4. Combination Risk Assessment and Lead-Based Paint Inspection

It is sometimes advisable to conduct *both* a lead-based paint inspection and a risk assessment. Both inspection and risk assessment may be required by regulation. By combining measurements of dust and soil with surface-by-surface paint analysis, and by collecting maintenance and management data, lead-based paint hazards can be identified and addressed in a comprehensive fashion, employing the best mix of interim control and abatement strategies. If a lead-based paint inspection has been completed before the start of a risk assessment, the risk assessor will often be able to reduce the time spent on the assessment, yet offer much more comprehensive advice. However, the risk assessor should ensure that the paint inspection was conducted properly before relying on its results. The evaluation of previously conducted paint testing is discussed later in this chapter, in Section II.F.1.

5. Selective Testing

- a. **Paint Testing.** Testing the paint of only certain surfaces for lead is often used before rehabilitation or other renovation or maintenance activities. If only certain paint surfaces are to be disturbed, it may make sense to test them in order to know whether the paint is lead-based paint and thus whether full lead-safe work practices are needed during the work. Paint testing is allowed by the Lead Safe Housing Rule before rehabilitation or other

renovation or maintenance activities in HUD-assisted target housing (see Appendix 6). If only certain paint surfaces are to be disturbed, those surfaces can be tested in order to know whether the paint is lead-based paint and thus whether lead-safe work practices are needed during the work.

- b. **Taking Additional Samples.** A risk assessor, in order to provide the client with some additional useful information, may want to test a few more paint surfaces or take a few more soil samples in the course of a risk assessment than are normally required. This is especially appropriate if the client is a family with very young children. For example, EPA regulations do not require that chewable surfaces be tested unless there is evidence of teeth marks, but the parents may want to know which chewable surfaces have lead-based paint, if any, so they can temporarily cover such surfaces with vinyl or heavy plastic. Similarly, with regard to soil, if there is a possibility of lead contamination, as in old urban neighborhoods, a young family may want soil to be tested even if it is currently not bare. (See Table 5.2 for information on how prevalent soil-lead hazards are.) Then they can protect against future exposure if hazardous levels of lead are present.

Table 5.2 Percentage of Housing Units with Significant Lead-Based Paint Hazards, and Percentage with Bare Soil Lead Levels in Yard \geq 1200 ppm, United States, 2005-2006*.

Hazard	Year of Construction			
	1978-2005	1960-1977	1940-1959	Before 1940
Significant Lead-Based Paint Hazards *	3%	11%	39%	67%
Bare Soil in Yard Equal to or Exceeding 1,200 ppm **	0.3%	0.3%	4%	14%

Source: HUD, 2011. See also Jacobs, 2002, for which the construction-year percentages for a similar survey conducted in 1998-1999 were 3% (for 1978-1998), 8%, 43%, and 68%, respectively, for significant hazards, and 0% (for 1978-1998), 0%, 14% and 19% for bare soil \geq 1200 ppm.

* A "significant" lead-based paint hazard is any paint-lead, dust-lead or soil-lead hazard above de minimis levels in HUD's Lead Safe Housing Rule (24 CFR 35.1320(b)(2)(ii)(B) or 35.1350(d), as applicable).

** Measured when total amount of bare soil in yard exceeded 9 square feet.

6. Bypassing Evaluation, and the Option to Presume

These *Guidelines* generally discourage owners from skipping the evaluation process. However, property owners have the option of not conducting a risk assessment or other evaluation and, instead, presuming that all painted surfaces are coated with lead-based paint and all possible lead hazards exist in the unit, including hazardous paint, dust and soil. If the presumption option is taken, the owner should conduct all work that disturbs paint (and soil, if applicable) using

lead-safe work practices above the de minimis amounts as described in Chapter 8 and obtain a clearance examination. Some owners may be required by the HUD Lead Safe Housing Rule, or by state, tribal or local regulation, to control or abate all presumed hazards (i.e., all deteriorated paint and all bare soil). If the owner presumes the presence of lead-based paint and lead-based paint hazards, where interim controls are required, the owner should perform the standard set of interim control treatments (“standard treatments”) in the unit. Standard treatments require treatment of all possible lead hazards associated with the unit, including soil. Chapter 6 describes procedures for lead-safe maintenance that can be performed without an evaluation.

Important factors in deciding whether to evaluate or presume are typically based on which option is likely to be safest and most cost-effective. This calculation depends to a large extent on the probability of lead-based paint or lead-based paint hazards being present in a given property. The lower the probability of lead, the more likely it is that evaluation will be more cost-effective than presumption, because the costs of hazard control and/or lead-safe work practices are likely to be much lower if the evaluation finds few lead hazards than they would be if all surfaces, dust or soil were presumed to be lead-based, or have dust-lead hazards or soil lead hazards, respectively. If, as a result of a complete lead-based paint inspection, it is determined that there is no lead-based paint on the property, it is exempt from the HUD Lead Safe Housing Rule, the HUD-EPA Lead-Based Paint Disclosure Rule, the EPA Pre-Renovation Education (PRE) Rule, and the EPA Renovation, Repair, and Painting (RRP) Rule, (and, potentially, state, tribal or local regulations). On the other hand, if the likelihood of lead is high, the owner may calculate that it would be less expensive to presume its presence, and proceed on that basis when interim controls, abatement, renovation or maintenance are being conducted.

The likelihood of lead-based paint hazards or lead-based paint (whether hazardous or not) being present in a dwelling is closely associated with the age of the structure. Only 8 percent of housing units built between 1960 and 1977 in the United States are estimated to have “significant” lead-based paint hazards, compared to 68 percent for units built before 1940 (Table 5.1). Table 5.3 shows that for most building components, the presence of lead-based paint is not likely, especially in housing built after 1960 when lead-based paint was used infrequently. These data are from a national survey conducted primarily in 1999 and may not reflect the presence of lead in paint in a given dwelling or jurisdiction.

Table 5.3 Percentage of Component Types Coated with Lead-Based Paint, by Year of Construction, and by Interior or Exterior Location, United States, 2000.

Component Type	Year of Construction			
	1978-1998	1960-1977	1940-1959	Before 1940
Interior:	(%)	(%)	(%)	(%)
Walls, Floors, Ceilings	0	1	2	7
Windows	1	2	6	21
Doors	0	1	7	22
Trim	0	2	4	15
Other	0	1	2	12
Exterior:				
Walls	0	9	18	34
Windows	0	12	30	41
Doors	2	5	29	33
Trim	3	8	16	24
Porch	1	7	25	28
Other	0	8	37	37

Source: Jacobs, 2002. (Lead-based paint is defined as 1.0 mg/cm² or 5,000 ppm lead, in accordance with the Federal standard.)

B. The Risk Assessment Process

The risk assessor is a trained professional certified by EPA or an EPA-authorized State, Tribe or Territory as being capable of objectively analyzing lead-based paint hazards. Property owners may choose to have a member of their management staff trained and certified to aid in the decision making process, but such an assessor may not be perceived as being able to provide an unbiased evaluation of the property. Therefore, the owner may want to consider contracting with an independent, certified risk assessor to minimize the perception of bias (which might be important in the event of litigation). For similar reasons, the owner may want to consider whether it is prudent to employ the risk assessment firm to perform the actual lead hazard control work, since this would create a conflict of interest by providing an incentive to identify nonexistent lead hazards or to suggest controls that are not necessary or cost effective.

The risk assessment process begins with the collection of information about the property from the owner or resident (if the property is occupied). This information can often be collected by telephone. For individual dwelling units, Form 5.0 (can be found at the end of the chapter) is used and the information includes resident use patterns, such as where young children who are in residence play, both inside and outside. For multiple units in multi-family properties, the information is recorded on Form 5.6 (can be found at the end of the chapter) or a similar form, and it includes details about management and maintenance practices and the occupancy status of buildings. The risk assessor will use this information to make decisions about the location of the limited environmental testing within the dwelling or the property. If the risk assessment involves the evaluation of five or more similar dwellings, the risk assessor will select a limited number for sampling using specific criteria. The risk assessment entails both: 1) a visual assessment of the selected dwelling units and common areas and 2) environmental testing, which includes testing of deteriorated paint and (if needed) other painted surfaces and collection of dust and soil samples. Usually, paint is tested with a portable X-ray fluorescence (XRF) analyzer but sometimes by collecting paint chip samples. The environmental samples are then sent to a laboratory recognized by NLLAP for analysis of lead in paint, dust or soil, as applicable.

When the lab results or XRF measurements are received, the risk assessor reviews and analyzes all data, including visual assessment results, environmental sampling results, and management and maintenance information. The risk assessor then drafts a report identifying lead-based paint hazards and acceptable lead hazard control options. Options should include a spectrum of treatments ranging from interim controls to abatement of all identified lead hazards. The control options should take into account the condition of the property and the location and severity of lead-based paint hazards, based on criteria established in these *Guidelines* and federal or other regulations. The owner must decide which hazard control option is most appropriate for the property and develop a plan to implement that option. To the extent possible, risk assessors should provide a range of options for all cases. EPA has also published information about the risk assessment process in owner-occupied, single-family dwellings (EPA, 1994). EPA regulations on risk assessments can be found at 40 CFR 745.227(d).

C. Limitations of This Risk Assessment Protocol

1. Risk Assessments of Dwellings Housing Children with Elevated Blood Lead Levels

The risk assessment protocol contained in this chapter may not be sufficient for an investigation of a dwelling presently housing a child with an elevated blood lead level (EBL). As of

the publication of these *Guidelines*, HUD regulations, at 24 CFR 35.110, define an “environmental intervention blood lead level” as a confirmed concentration of lead in whole blood equal to or greater than 20 µg/dL for a single test or 15-19 µg/dL in two tests taken at least 3 months apart. This definition is based on guidance from the Centers for Disease Control and Prevention (CDC, 2002, Chapter 2). A more comprehensive investigation of all sources of lead is necessary when there is a child with an EBL, because it is possible that the exposure is unrelated to the residential property (e.g., it may be related to personal property, such as glazed pottery or leaded toys) or that another site is the source of the poisoning. For more information about investigations involving children with EBLs, refer to Chapter 16, consult with state and local health departments and childhood lead poisoning prevention programs, and review the protocols and recommendations issued by the CDC. In particular, because CDC issued recommendations shortly before the publication of this edition of these *Guidelines*, HUD and EPA had not completed their reviews of the implications of the CDC recommendations by the publication date. These *Guidelines* may be revised once these reviews are completed.

2. Assessment of Less Common Sources of Lead Exposure

In order to evaluate the largest number of dwellings in the shortest period of time, these *Guidelines* do not recommend assessing *all* potential sources of lead at each property. Instead, these *Guidelines* recommend assessing the *most likely* sources of lead hazards that are within the control of the property owner. Private risk assessors have an obligation only to investigate those lead exposures that are directly related to the residential property, although other obvious sources should be noted. For example, if it is known that the use of folk remedies containing lead is widespread in a given neighborhood, risk assessors should not try to analyze these remedies but should mention the potential source in their final report. EPA has published information on additional sources of lead and how they should be addressed (EPA, 1994). Additional information on lead in consumer products is available from the Consumer Product Safety Commission’s website at: www.cpsc.gov.

Many risk assessors routinely test non-paint items for lead content when they conduct risk assessments. Ceramic tile, and ceramic bath fixtures are sometimes tested because they may be a source of lead exposure during demolition or renovation. Lead-containing ceramic tile or bath fixtures are not a common cause for childhood lead poisoning. However, demolition activities such as breaking or crushing them may release lead. Similarly, some risk assessors test vertical miniblinds because some models have been found to release lead when exposed to sunlight (<http://www.cpsc.gov/CPSCPUB/PREREL/PRHTML96/96150.html>). For this reason, some risk assessors test these items when they conduct pre-rehabilitation risk assessments and reference the OSHA lead in construction standard (29 CFR 1926.62) in their reports (see Appendix 6). Project specifications should require that construction or/demolition contractors comply with the applicable provisions of the OSHA standard when employees have potential lead exposure from any source.

Air sampling is not recommended for routine risk assessments of housing. The levels of airborne lead in a residence are expected to be low unless there is an identifiable lead air emission source nearby. If a source is identified, it should be noted in the final report, but the responsibility for action rests with public agencies. Significant airborne emissions are likely to be reflected in settled dust-lead levels.

Water sampling is also optional for routine risk assessments. If a client is concerned about plumbing within the building and specifically requests water testing, the risk assessor should have the water analyzed or refer the owner to the local water authority, which may conduct such tests at no charge. Information on municipal water quality can be obtained from the EPA Drinking Water Hotline (800-426-4791). (Hearing- or speech-challenged individuals may access this number through TTY by calling the toll-free Federal Relay Service at 800-877-8339.) In communities where water contamination appears to be especially prevalent, EPA requires public water suppliers to evaluate and correct the problem. Additional guidance on water sampling is provided at Section II.H, below.

D. Non-Federal Standards

Standards and procedures described in this chapter are those established by EPA and HUD. Some States, Tribes, and local governments have different requirements. If such a requirement is more stringent or more protective than a federal standard, the local, not the federal, requirement applies. This is true even if the housing is federally assisted. If a local standard is less stringent, the federal standard applies if the housing is federally assisted. Therefore, risk assessors, local program administrators and property owners and managers should become familiar with the lead-based paint requirements of their jurisdictions.

II. Data Collection

The data collection phase of the risk assessment includes the administration of a questionnaire, an assessment of the condition of the building, a visual assessment of the buildings, other structures and common areas on the property being evaluated, and a limited amount of paint, dust, and soil testing. Forms for the questionnaires, condition survey, visual assessment, and on-site testing and sampling are provided at the end of this chapter.

A. Questionnaires

1. Individual Occupied Units (Form 5.0)

Before conducting the visual assessment and environmental testing of individual occupied units, the risk assessor should administer the questionnaire provided at Form 5.0 (or a similar questionnaire) to an owner-occupant or, if the unit is rented, to an adult resident and the owner. If the family includes young children, it is preferable that the resident respondent be a parent or guardian. The purpose of the questionnaire is to obtain information on family use patterns (e.g., where young children, if any, sleep, play and eat; use of entrances and windows; house cleaning; gardening) and recent renovations. This information is used to determine where to collect dust and soil samples. Some of the information may also be useful in educating the owner and residents about risks of possible future lead exposure.

This questionnaire should be administered with all risk assessments of occupied individual units regardless of the type of structure in which the unit is located. If the unit is not occupied, a questionnaire such as Form 5.0 should not be administered. In unoccupied units, the risk assessor decides which rooms to sample based on general assumptions about the probable use patterns of a family with a young child that might live there, as explained below in Section

II.E. Also, this questionnaire is not necessary if a lead hazard screen is performed instead of a full risk assessment.

The risk assessor may administer the questionnaire by telephone or in person. However, before administering it, the risk assessor should prepare a sketch of the floor plan of the unit, with each room named, or obtain such a plan from the owner, and attach it to the questionnaire. This will help clarify room names used in the questionnaire, and will also be used during the risk assessment to document sample locations and other information. Also, a floor plan will be essential during the visual assessment and environmental testing. An explanation of the questions on Form 5.0 accompanies the form at the end of this chapter.

2. Multi-family Rental Properties (Form 5.6)

If the risk assessment encompasses five or more rental dwelling units under the same ownership, the questionnaire at Form 5.6 (or a similar questionnaire) should be completed by the owner. Instructions are provided with the form. Generally it is not easy or useful to administer the questionnaire for individual units (Form 5.0) (or a similar questionnaire) to residents in multi-family risk assessments.



FIGURE 5.2 Risk Assessor interviewing a resident.

B. Floor Plan and Site Plan Sketches

As stated above, the risk assessor should prepare or obtain from the owner a sketch of the floor plan (or equivalent) of each dwelling unit and common area to be visually assessed. Rooms, other spaces and walls should be labeled, and the same designations should be used in Forms 5.2, 5.3, 5.4 and 5.5, or similar forms. Windows and doors should also be shown on the sketch and identified on the forms.

The risk assessor should also prepare or obtain a site plan sketch (or equivalent, such as a plat) showing the approximate outline of the property, buildings, other structures (including fences), driveways, and adjacent streets. The sketch should have an arrow to indicate the direction north. This sketch has the purpose of clarifying locations of exterior deteriorated paint (Form 5.2) and bare soil (Form 5.5) and the locations of testing and sampling of both paint and soil.

C. Building Condition Inspection (Form 5.1)

The risk assessor should conduct a visual assessment of the condition of the building(s) and record all findings on Form 5.1 or a similar form. This has three purposes: (1) meets EPA's requirements (40 CFR 745.227(c) and (d)) that information on the physical characteristics of the dwelling be obtained during lead hazard screen and risk assessment; (2) to assist in determining whether to perform a lead hazard screen; and, (3) to gain insights into possible causes of existing or future paint or substrate deterioration. For example, a roof in disrepair should be noted since moisture could cause paint deterioration. In addition, a poorly maintained building may indicate that an owner is also unlikely to maintain interim controls.

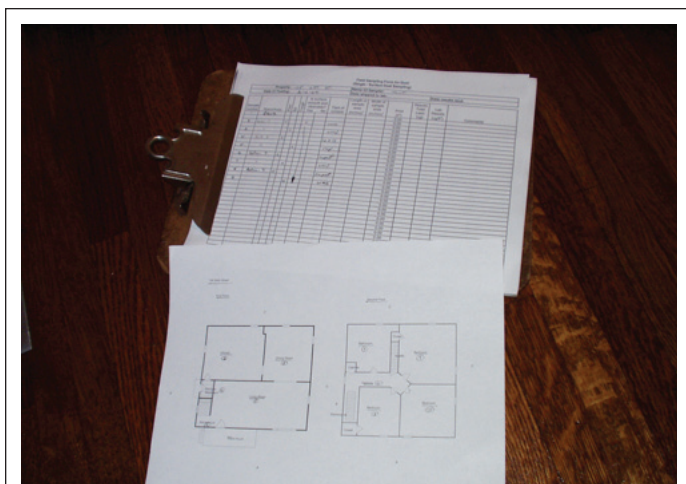


FIGURE 5.3 Record of sampling locations and floor plan sketch.

If the risk assessor believes the likelihood of finding lead-based paint hazards in a property is low and therefore proposes to perform a lead hazard screen instead of a full risk assessment, he or she should document the condition of the building and complete Form 5.1 or similar form. This building condition inspection should be performed before the visual assessment and environmental testing in order to assure that a lead hazard screen is appropriate for the property. If a full risk assessment is to be performed, the risk assessor can conduct the visual assessment of building condition at the same time as the visual assessment.

Form 5.1 lists a selected number of physical problems that indicate structural or water damage. This is not an exhaustive list of possible problems. Most risk assessors could suggest other conditions that may cause paint deterioration and/or indicate poor maintenance practices. It is, however, an adequate list for the purposes of determining whether a building is in good enough condi-

tion to make a lead hazard screen appropriate. If two or more of these listed conditions are present and a lead hazard screen is performed, the risk assessor should explain on the form the extenuating circumstances for that property that make a lead hazard screen appropriate. If a full risk assessment is performed, the risk assessor can use the space at the bottom of the form to note additional conditions that he or she thinks could cause lead hazard control problems. Having this information will be useful in preparing recommendations in the final report on acceptable options for controlling lead-based paint hazards and in recommending to the client any additional repairs or changes in maintenance practices that will help protect the dwelling from developing hazards in the future.

D. Visual Assessment

1. Overall Scope and Purpose

The purpose of the visual assessment element of the risk assessment is to locate potential lead-based paint hazards, both exterior and interior. Within a dwelling unit, the visual assessment should be conducted in all rooms. In multi-family buildings, the visual assessment should include examination of common areas adjacent to sampled dwelling units (see Section III.B, below, regarding unit sampling) and other common areas in which one or more children under age 6 are likely to come in contact with dust. The risk assessor should also examine exterior painted surfaces, including fences and outbuildings that are part of the residential property (such as garages, fences and storage sheds) as well as buildings with living spaces. Also, the risk assessor should examine the grounds to identify bare soil. The result should be a complete inventory of the location and approximate size of each instance of:

- ◆ Deteriorated paint that may be lead-based paint,
- ◆ Friction surfaces coated with paint that may be lead-based paint,
- ◆ Impact surfaces coated with paint that may be lead-based paint,
- ◆ Chewed surfaces coated with paint that may be lead-based paint,
- ◆ Deteriorated substrate conditions, and
- ◆ Bare soil.

The risk assessor will use these data, in conjunction with results of the questionnaire, to select locations for dust sampling, paint testing, and soil sampling. Then, in conjunction with the environmental testing results and the building condition inspection, the visual assessment data are used in preparing a report that includes the following information for the property in question:

- ◆ The location and approximate size of all paint-lead hazards, including deteriorated lead-based paint, friction-surface hazards, impact-surface hazards, and chewable-surface hazards,
- ◆ The specific location of all dust-lead hazards,
- ◆ The location and approximate size of all soil-lead hazards,
- ◆ Acceptable options for interim control or abatement of each paint-lead, dust-lead, and soil-lead hazard, and whether each option is considered an interim control or abatement in that state,
- ◆ Recommendations for ongoing lead-safe maintenance and repairs (optional), and
- ◆ Other general educational information (optional).

If a lead-based paint inspection has already been conducted, the risk assessor should review it to determine if the findings are reliable (see Section II.F.1, below, and Chapter 7). If the data are useable, the assessor should focus on the painted surfaces that are known to contain lead-based paint. In dwellings where no inspection has been conducted, any painted surface that has not been replaced after 1977 must be presumed to contain lead-based paint. However, in properties covered by the Lead Safe Housing Rule, all components, even if they were replaced after 1977, are presumed to contain lead-based paint unless they are tested and the inspection proves they do not contain lead-based paint. Risk assessors should never presume that replacement components do not contain lead-based paint and should test all deteriorated painted surfaces. This practice is very important given the recent popularity of reinstalling salvaged building components.

2. Documentation of Locations

Risk assessors should carefully document the location of each potential hazard in order to accurately and efficiently combine information from the visual assessment with environmental sampling results and thus to be able to evaluate findings, determine acceptable options for hazard control, and clearly describe this information in a report to the client, often without returning to the site. The information in the report should be in a format and level of detail that can be easily used by the client or the client's contractor in preparing a work write-up.

There are several ways to document precise locations, but a floor plan sketch is always recommended. A site plan sketch is necessary if the locations of exterior painted surfaces or bare soil are to be identified. For a small single dwelling unit with few instances of deteriorated paint, the risk assessor may describe the location of each potential hazard on a floor plan sketch and number each item with a corresponding number on Form 5.2 or similar form. For buildings that are larger or have a large number of potential hazards, a combination of a floor plan sketch with a standard numbering system is recommended. One numbering system is as follows:

- a) *Side and wall identification.* Identify sides of the structure with letters. For example, Side A is usually the street side for a single-family house. For an apartment in a multi-family building, Side A is the side of the main entry to the unit. Sides B, C, and D are identified clockwise from Side A. Show the building side designations on a site plan sketch (which shows the outline of the building and the principle features of the grounds).
- b) *Room equivalent identification.* Room equivalents should be identified by both a number and a use designation, such as "Room 5, Kitchen." Room 1 may be the first room, at the entryway, or it may be the exterior room equivalent. A floor plan sketch is recommended for documenting room identification. If there are several bedrooms, for example, the plan will identify which room has which number.
- c) *Sides in a room.* Some risk assessors and lead-based paint inspectors prefer to designate the sides of each room or room equivalent using the same designation system as for the sides of the structure or apartment, as explained above. They do not base room side designations on the location of the door to the room, because some rooms have more than one door. Other risk assessors and inspectors have found that room sides should be based on a reference door, because it is easy to get confused and lose orientation to the street side or the apartment entrance, especially when windows are nonexistent or boarded up. Under the reference door system, it is essential that the reference door be properly identified when there is more than one door to a room (e.g., wooden door from hallway, or stained door from bathroom). In either case, sides are designated clockwise. If facing Side C, Side A should be at your back, and Side B should be on your left, except in odd shaped rooms, which may require a special identification (another reason for a floor plan sketch). If there is more than one closet in a room, use the side designation; for example, "Room 3, Master Bedroom, Side C, Closet."
- d) *Component identification.* Individual building components are identified by their room number and side allocation; for example, "Radiator, Room 1, Side C." If there is more than one of a component type on a room side, they are numbered from left to right when facing the wall with the components. For example, "Window, Room 1, Side C, Number 1," which could be abbreviated as "Window, 1,C,1."

Whatever numbering or identification system is adopted to designate walls, rooms and components, the system used should be understandable from records included in the risk assessment report, and the descriptions as to the locations of identified hazards must be unambiguous. Definitions or codes used in the numbering or identification system should be defined and reported.

If the risk assessor is unable to gain access to a portion of the property that was to be evaluated for the risk assessment, she or he should contact the owner or owner's agent to gain that access. If this is ultimately unsuccessful, the risk assessor should annotate the site sketch and/or location listing, and mention this inability in the risk assessment report.

3. Identification of Deteriorated Paint (Form 5.2)

Hazard Definition

EPA regulations define deteriorated paint as “any interior or exterior paint or other coating that is peeling, chipping, chalking or cracking, or any paint or coating located on an interior or exterior surface or fixture that is otherwise damaged or separated from the substrate” (40 CFR 745.63).

What to Look For

Every risk assessment must include a thorough visual assessment to identify any and all interior or exterior surfaces with deteriorated paint that may be lead-based paint. The risk assessor should inspect painted surfaces in every room and every exterior painted surface. Remember to examine the exterior as well as interior of windows, including frames and sills as well as sashes. Ignore such minor instances hairline cracks and nail holes, which are not considered to be deterioration with respect to designating the paint as deteriorated.

Figure 5.4a through 5.4c illustrates paint conditions that can be grouped into two general categories: bulk deterioration and layered deterioration (NDPA, 1990). While it is not necessary to record the type of paint deterioration, different types of paint deterioration will require different hazard control solutions. For example, if paint is “alligatoring” on a surface, and the cause appears to be too many layers of paint, a risk assessor should recommend component replacement or paint removal before paint film stabilization. Applying additional layers of new paint to an alligatored paint film will be ineffective.

EPA regulations include chalking as a form of paint deterioration. Therefore, risk assessors must identify chalking paint. These *Guidelines*, however, no longer consider chalking to be a form of paint deterioration that must be corrected to prevent childhood lead poisoning. The reason is that it is the top, or exterior layer of paint that chalks, and thus a painted surface must have gone without repainting for some 30 years (at the time of this writing) for lead-based paint to be the outside layer. (Very little lead-based paint was used in the 1970s, even for exterior surfaces.) If paint has existed that long, other forms of deterioration will be present.

Also, these *Guidelines* no longer consider mildew on paint to be deteriorated paint. Mildew is a *cause*, not a form, of paint deterioration, and perhaps of other potential health problems as well. Removal of mildew is not required unless the paint is in fact deteriorated and is lead-based paint. Otherwise, the risk assessor may wish to call the client’s attention to mildew and suggest that it be removed as a preventive measure.

Definitions and causes of paint deterioration are described in the following paragraphs. The first three types of deterioration — checking, cracking, flaking and alligatoring — are referred to as “*bulk deterioration*.”

1. **Checking** – A pattern of short, narrow breaks in the top layer of paint that is usually caused by a loss of elasticity. Plywood substrates can often cause checking. The deteriorated paint should be removed if a new coating is to be applied.
2. **Cracking and Flaking** – An advanced form of checking that usually occurs on surfaces with multiple layers of paint and includes breaks in the film that extend to the base substrate.

The cracks usually form parallel to the grain of the wood. The damaged coating should be removed if a new coating is to be applied.

3. **Alligatoring** – Reptilian scale patterns on dried paint films that are often caused by the inability of the topcoat to bond smoothly to a glossy coat underneath. The old paint should be completely removed and the surface should be primed and repainted. Alligatoring is usually associated with paint films that are too thick, or the application of a brittle coating over a more flexible one. In some cases it may be necessary to remove all of the paint before recoating, since the existing paint film is already too thick. Enclosure or component replacement will probably be the most effective and safe hazard control methods in this circumstance.

FIGURE 5.4 Forms of Paint Deterioration



FIGURE 5.4a Peeling paint



FIGURE 5.4b Alligatoring paint

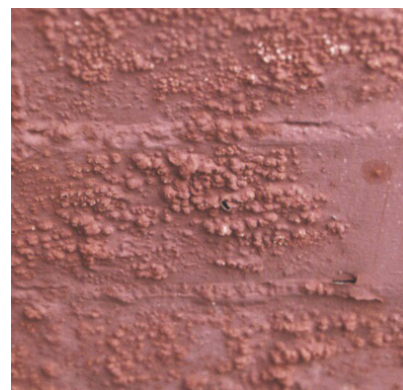


FIGURE 5.4c Blistering paint

The following six types of paint deterioration are referred to as “layered deterioration.”

1. **Blistering** – The formation of bubbles in the paint film caused by either heat or moisture. The risk assessor should break open one of the bubbles; if bare substrate shows, then the likely cause is moisture. However, if another layer of paint shows instead of substrate, heat probably caused the blister (not moisture). The risk assessor should endeavor to locate the moisture source if moisture is suspected. Control of the moisture source will lengthen the effective life span of many forms of lead-based paint hazard control, especially paint film stabilization.
2. **Scaling or Flaking (peeling)** – A form of paint separation often found in those exterior areas of the building susceptible to condensation, such as under eaves. Salt deposits drawn to the paint film surface can cause scaling. The deteriorated paint should be removed, and the salts should be washed off if the surface is to be recoated. Enclosure may be the most effective and safe hazard control method for this type of deterioration.
3. **Peeling From Metal** – A form of paint separation usually caused by improper priming of bare, galvanized metal, or by rusting (often seen on garage doors). The loose paint should be removed by wet scraping and the metal should be primed with a galvanizing primer or other primer made for metal before paint film stabilization. Industrial paints containing lead should not be used to prime metal surfaces. Component replacement and enclosure are likely to be most effective.

4. **Peeling From Exterior Wood** – A type of paint deterioration usually resulting from wet wood swelling under paint, causing the paint film to loosen, crack, and dislodge. The water may be present because of either moisture passing through the substrate from the interior (poor ventilation) or exterior sources of moisture penetrating the paint film. The risk assessor should recommend that the cause of the moisture problem be discovered and addressed before attempting paint film stabilization or any form of recoating.
5. **Peeling From Plaster Walls** – Peeling from plaster walls could be the result of insufficient wet troweling of the white coat when the plaster was applied, causing chalking of the surface. Both the use of glue size, which absorbs water, and use of a primer with poor alkali resistance can also cause deterioration.
6. **Peeling From Masonry Surfaces** – Peeling from masonry surfaces is often caused by the alkaline condition of the surface. A coating system that is appropriate for alkaline surfaces should be used.

Field Report

Form 5.2, at the end of this chapter, can be used to identify the location of each occurrence of deteriorated paint, exterior as well as interior. Under the “Location” column, the risk assessor should document the location in a manner described in Section II.D.2, above. (Note that Forms 5.2 and 6.0 both cover visual assessments, the former for risk assessments, and the latter for visual assessments; intentionally, they are identical, which is why the forms have double titles.)

Record the room (or side of the building if exterior), the building component – see the illustrative but not exhaustive list of components in Table 5.4 below – and any other information necessary to clarify the location. It is important to provide the precise location and amounts of deteriorated paint to the owner so the proper building components and areas can be repaired.

The risk assessor should estimate and record the approximate area of all identified deteriorated paint surfaces, by room-side and component. If there are several occurrences of deteriorated paint on the same room-side/component combination, enter an estimate of the total area of deterioration. This estimate does not have to be precisely measured; it is an approximation. Its purpose is to facilitate preparation of the risk assessment report and the subsequent work write-up by or for the client. In the United States, the estimate should be expressed in square feet, because these are the units generally used by the construction industry. If an area is less than one square foot, enter an approximate fraction or decimal of a square foot. For example, an area of about 4 in. x 4 in. would be

“1/10,” or “0.1,” because 4 times 4 equals 16, and 16 is about one-tenth of 144, which is the number of square inches in a square foot. Similarly, an area of about 6 in. x 10 in. would be “4/10” or “0.4.”

The risk assessor must determine, to the extent practicable, and record on Form 5.2, or similar form, whether the paint deterioration has been caused by a moisture problem, friction or abrasion, impact, deteriorated or damaged substrate, severe heat, or some other existing building deficiency. These conditions should be corrected before repainting. The type of deterioration (i.e., blistering, flaking, etc.) may yield information about necessary hazard control treatments. For example, if the type of deterioration is commonly caused by moisture in the substrate, the moisture problem will need to be addressed before the paint can be stabilized.

Table 5.4 Illustrative List of Painted Components.*

Interior:	Exterior:
Balustrades	Air conditioners
Baseboards	Balustrades
Bathroom vanities	Beams
Beams	Chimneys
Cabinets	Columns
Ceilings	Corner boards
Chair rails	Doors and trim
Columns	Fascias
Counters	Fences
Crown molding	Garages and garage doors
Doors and trim	Gutters and downspouts
Fireplace mantels or surrounds	Handrails
Floors	Lattice work
Handrails	Painted roofing
Interior window sills (stools) and aprons	Porches and balconies
Newel posts	Railings and railing caps
Radiators	Rake boards
Shelves	Sashes
Stair stringers	Siding
Stair treads and risers	Soffits
Walls	Stair risers and treads
Window sashes and trim	Stair stringers
Window jambs and channels	Windows and trim

* This is not an exhaustive list. Also see Table 7.1.

Small Amount Designations

For each area of deteriorated paint, the risk assessor should also note whether its size falls within the “*de minimis*” amounts. The “*de minimis* amounts” refer to specific thresholds in HUD and EPA regulations that dictate how control or repair must be performed. All deteriorated lead-based paint must be controlled or abated, regardless of the amount of paint present. Lead hazard control or repair work on amounts of paint below the *de minimis* do not require the use of trained or certified workers, lead-safe work practices, including occupant protection, clearance and notice to residents (if required), although HUD recommends such activities any time known or presumed lead-based paint is disturbed. Therefore, the risk assessor must identify all areas of deteriorated paint and their size/amounts. (The term “*de minimis*” is shorthand for the phrase “*de minimis non curat lex*,” Latin for “the law takes no account of trifles” (Merriam-Webster Dictionary; <http://www.merriam-webster.com>.)

Specifically, the *de minimis* amounts of paint are amounts that do not exceed: (a) 20 square feet on exterior surfaces, (b) 2 square feet in any one interior room or space, or (c) 10 percent of the total surface area on an interior or exterior component type with a small surface area (such as window sills, baseboards, or trim; see Figure 5.5). The *de minimis* threshold applies to abatement activities regulated by EPA as well as to interim controls and maintenance activities regulated by HUD. For EPA policy, see 40 CFR 745.65(d); for HUD policy, see 24 CFR 35.1350(d) and the Interpretative Guidance to HUD’s Lead Safe Housing Rule posted on HUD’s website at: http://portal.hud.gov/hudportal/HUD?src=/program_offices/healthy_homes/enforcement/lshr.

Note that the HUD *de minimis* thresholds are different from the EPA’s *minor repair and maintenance activities* thresholds (40 CFR 745.83) under its RRP Rule for work that that disrupts:

- (1) 6 square feet or less of painted surface per room for interior activities; or
- (2) 20 square feet or less of painted surface for exterior activities; provided that none of the work practices prohibited or restricted by 40 CFR 745.85(a)(3) were used and where the work does not involve window replacement or demolition of painted surface areas (see Appendix 6 for details).

4. Identification of Friction Surfaces (Form 5.2)

Hazard Definition

Risk assessors are required to identify and test deteriorated paint on “friction surfaces.” EPA regulations define a friction surface as a surface that is subject to abrasion or friction (40 CFR 745.63). Friction surfaces are given special attention because lead-based paint that is subject to friction or abrasion is likely to generate lead-contaminated dust. Research confirms this to be the case (Tohn, 1997).



FIGURE 5.5 Baseboard showing a *de minimis* amount of deteriorated paint.

EPA regulations state that “any lead-based paint on a friction surface” is a lead-based paint hazard if the surface “is subject to abrasion and where the lead-dust on the nearest horizontal surface underneath the friction surface (e.g., the window sill, or floor)” equals or exceeds applicable dust-lead standards (40 CFR 745.65(a)(1)). Therefore, to determine that a friction-surface hazard is present, it is necessary to find that:

- ◆ The surface is a friction surface coated with lead-based paint, **and**
- ◆ The lead in dust underneath the friction surface equals or exceeds dust-lead standards.

If a surface is determined to be a friction-surface hazard, the risk assessor should recommend hazard controls that eliminate the friction or abrasion.

If the paint on any friction surface is *deteriorated* and the paint is lead-based paint, the deteriorated paint is a *deteriorated-paint hazard*. However, the same surface may also be a friction-surface hazard, and it is necessary to determine if that is the case. If the paint on a friction surface is *intact*, i.e., not deteriorated, it is also necessary to determine if the surface is a friction-surface hazard so the owner can monitor the paint's condition.

What to Look For

Surfaces subject to friction or abrasion are surfaces that are being worn down due to rubbing or surface scratching. The most common examples of painted friction surfaces are: (1) a double-hung window sash rubbing against a window channel, with one or both of the surfaces painted; (2) painted floors and painted stair treads; and (3) painted kitchen counters and shelves on which there is abrasive contact by objects used for cooking or eating, and similar surfaces such as painted drawers and slides. These are friction-surface hazards only if the paint is lead-based paint and the dust underneath the surface (or on it, in the case of floors and stair treads) is a dust-lead hazard.

To determine whether there is a possible lead-based paint hazard on a friction surface on a double-hung window or a door, risk assessors should, during the visual assessment:

- ◆ **Examine the windows to determine whether they are operable.** If a window is not operable, that is, if the sash does not go up and down, there is not likely to be any friction, and therefore a friction-surface hazard is improbable. (Building codes typically require that there be means of egress from each bedroom. If there are no operable windows in a bedroom, there may be a code violation. Although this subject is not within the scope of a lead hazard risk assessment, the risk assessor may want to mention this problem to the owner.)
- ◆ **For each operable window, determine whether there is paint on surfaces subject to friction or abrasion.** A common friction surface is where channels and sashes rub against each other. Most double-hung windows, even those that operate smoothly and easily, have some contact between sash and channel. If there is no paint on these contact surfaces, there can be no friction-surface paint hazard. If there is paint, determine whether it is deteriorated or intact and record same on Form 5.2, or similar form. Also look to see whether the interior side of the bottom of the sash is rubbing against the back of the interior window sill (the stool) and record the findings if paint is being affected.
- ◆ **Doors: Examine the doors to determine whether any door rubs against its jamb or header and, if so, whether any of those friction surfaces are painted.** Also examine the hinges.

They are sometimes sloppily painted and have ongoing deterioration of paint. If there are no friction surfaces or if there is no paint on friction surfaces, there can be no friction-surface paint hazard. If there is paint on a friction surface, determine whether it is deteriorated or intact and record same on Form 5.2, or similar.

The visual assessment field report (Form 5.2 or similar form) should record positive visual findings for each window or door that may have friction-surface hazards, pending dust-lead sample results. Examine at least one operable window and one door in each room that is likely to be frequented by young children.

Floors and stair treads. To determine whether there is a possible lead-based paint hazard on a painted floor or stair tread, risk assessors should, during the visual assessment, identify all painted floors or stair treads that are not protected from abrasion by foot traffic by rugs or other coverings, determine whether paint on each of these surfaces is or is not deteriorated, and record the location and condition of paint for each surface on Form 5.2 or similar form.

Kitchen counters and shelves (optional). To determine whether there is a possible lead-based paint hazard on painted kitchen counters and shelves and similar surfaces, risk assessors should, during the visual assessment, identify all painted counters and shelves that may be subject to abrasive contact by objects used for cooking or eating, determine whether paint on each of these surfaces is or is not deteriorated, and record the location and paint condition for each surface on Form 5.2 or similar form. This is an optional activity with regard to identification of friction surfaces. However, all deteriorated paint on these built-in surfaces must be identified and recorded. It should be noted that there is no EPA lead hazard standard for dust on counters, shelves, drawers



FIGURE 5.6a Friction hazard on stairs pre-treatment.



FIGURE 5.6b Friction hazard on stairs post-treatment.

or similar surfaces. These *Guidelines* recommend using the floor dust standard, because it is more stringent than the interior window sill standard, and it is reasonable to use a stringent standard for dust that may contaminate food.

Field Report

Form 5.2 is designed to be used in the following manner: As described above, if there is *deteriorated* paint on a friction surface and it appears that friction or abrasion is at least one of the causes of the deterioration, enter "Friction" under the column heading, "Probable Cause of Deterioration, if Known." If there is *intact* paint on a friction surface, enter "Y" or "Yes" under the column heading, "Intact Paint on Friction Surface?"

5. Identification of Impact Surfaces (Form 5.2)

Hazard Definition

EPA regulations (at 40 CFR 745.63) defines an impact surface as "an interior or exterior surface that is subject to damage by repeated sudden force, such as certain parts of door frames." EPA has determined that an impact surface is a lead-based paint hazard if there is "damaged or otherwise deteriorated lead-based paint on an impact surface that is caused by impact from a related building component (such as a door knob that knocks into a wall or a door that knocks against its door frame" (40 CFR 745.65(a)(2)).

In contrast to a friction surface, for which lead dust on the nearest horizontal surface underneath the friction surface must equal or exceed the applicable dust-lead standards (see the discussion of friction surfaces in section II.D.4 above) for the surface to be a friction-surface lead-based

paint hazard. It is not necessary for a dust-lead measurement to be taken to establish that the impact surface is a lead-based paint hazard, only a measurement to determine that the paint on the surface is lead-based paint.

Damage caused solely by resident misuse (e.g., a child banging toys against a wall, a vacuum cleaner routinely being banged into baseboards) is not considered an impact surface under EPA regulations. Of course, if the paint is deteriorated lead-based paint, it is a lead-based paint hazard, and if the cause appears to be impact due to misuse, the risk assessor should note the fact and inform the client. Note that EPA does not require that there be a dust-lead hazard present below an impact surface for there to be a paint-lead hazard.

What to Look For

Risk assessors should operate doors to determine whether they are hung and stopped properly and, if not, whether there are impact surfaces with damaged paint. Risk assessors may exercise judgment in selecting doors for examination. The doors examined for impact may be the same as those examined for friction surfaces. If impact surfaces are found on the examined doors, all doors in the dwelling unit or common area should be examined for impact.

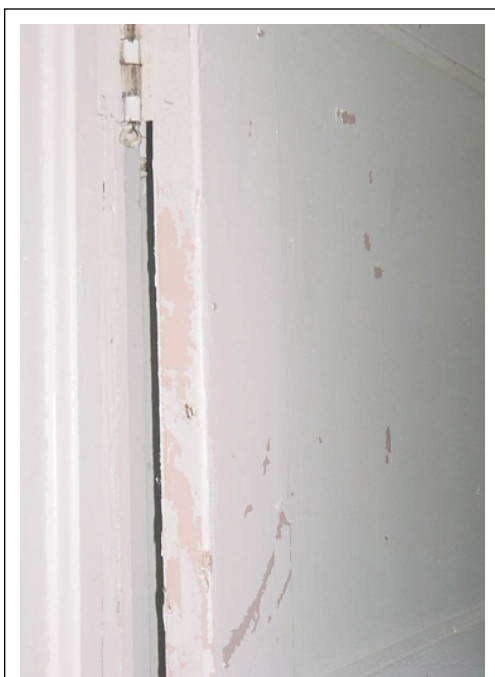


FIGURE 5.7 Impact surface on door and frame.

Field Report

Record "impact" as a cause of paint deterioration on Form 5.2 (or similar form).

6. Identification of Chewable Surfaces (Form 5.2)**Hazard Definition**

EPA regulations define a chewable surface as "an interior or exterior surface painted with lead-based paint that a young child can mouth or chew. A chewable surface is the same as an 'accessible surface' as defined in U.S Code 42 U.S.C. 4851b(2) (see Appendix 6). Hard metal substrates and other materials that cannot be dented by the bite of a young child are not considered chewable" (40 CFR 745.63).

What to Look For

The most common chewable surfaces are protruding interior window sills, but children have been known to chew also on baseboards, doors, balusters and other surfaces. Look for teeth marks on these surfaces. The risk assessor may wish to identify chewable surfaces that do not have teeth marks in evidence if the resident questionnaire reveals that young children currently in residence have a tendency to chew on painted surfaces. This is an optional activity that, combined with the results of paint testing of such surfaces, would give the parents or guardians information they can use to protect their children.

The risk assessor must identify chewable surfaces in accordance with the EPA hazard definition in order to be in compliance with EPA work practices requirements for risk assessments. However, these *Guidelines* hold that it is not necessary to require *treatment* of a chewable surface if a child of less than 6 years of age does not reside in the home or frequent the common area. A child is not poisoned by chewing that was done by someone else.

Field Report

If chewable surfaces with teeth marks are found, record the location in the "Location" column of Form 5.2 or similar form and enter "Yes," or a "Y" or a check in the column entitled "Visible Teeth Marks?" If the risk assessor wishes to identify chewable surfaces without teeth marks, record the location and enter "chewable, no teeth marks" or similar note in the "Notes" column.



FIGURE 5.8 Chewable surface: teeth marks on window sill.



FIGURE 5.9 Soil lead hazard at dripline

7. Identification of Bare Soil (Form 5.5)

Hazard Definition

EPA regulations define a soil-lead hazard as “bare soil on residential real property or on the property of a child-occupied facility that contains total lead equal to or exceeding 400 parts per million ($\mu\text{g/g}$) in a play area or average of 1200 parts per million of bare soil in the rest of the yard based on soil samples” (40 CFR 745.65(c)).

What to Look For

The visual assessment should include an examination of the grounds of the property to identify areas of *bare soil* in four types of areas: play areas, non-play areas in the dripline/foundation area, non-play areas in the rest of the yard, and vegetable gardens. While EPA regulations require only two categories (play areas, and the rest of the yard), these *Guidelines* recommend an additional focus on the dripline/foundation area because research has found that the average concentration of lead in soil is significantly higher there than in other parts of the yard (NCHH, 2004). Without a separate sample from the dripline / foundation area, one might perform needless hazard control or abatement of the rest of the yard when only the dripline/foundation area has soil lead in excess of hazard standards. As explained in Section V.A.1, below, and Table 5.11, below, these *Guidelines* recommend the use of the same standard of 1,200 ppm for non-play areas in the dripline/foundation area as for non-play areas in the rest of the yard. HUD also recommends that vegetable garden soil be sampled separately. Leafy vegetables and herbs can concentrate significant amounts of lead and gardens should be considered a high contact area (Finster, 2004).

HUD regulations define bare soil as “soil or sand not covered by grass, sod, other live ground covers, wood chips, gravel, artificial turf, or similar covering” (24 CFR 35.110). (EPA regulations do not have a definition of bare soil.) Covered soil is not considered a possible soil-lead hazard.

EPA defines dripline as “the area within 3 feet surrounding the perimeter of a building” (40 CFR 745.63), i.e., within 3 feet from the building wall. This definition applies as well to the term “dripline/foundation area,” which is used in these *Guidelines*.

EPA regulations define a play area as “an area of frequent soil contact by children of less than 6 years of age as indicated by, but not limited to, such factors as the following: the presence of play equipment (e.g., sandboxes, swing sets, and sliding boards), toys, or other children’s possessions, observations of play patterns, or information provided by parents, residents, care givers, or property owners” (40 CFR 745.63).

If one or more children under age 6 live in or regularly visit the home or building, or if the home or property is a child-occupied facility as defined by EPA (40 CFR 745.223), the risk assessor should base this identification on the questionnaires (Form 5.0 or Form 5.6), other discussions with people on the property, and visual evidence of toys, play equipment, etc.

In searching the dripline/foundation area and the rest of the yard for areas of bare soil, the risk assessor should examine gardens and pet sleeping areas, as well as paths and other areas. If there is a total of no more than one square yard (9 sq. ft.) of bare soil spots in *non-play areas* of the yard of each property, HUD regulations (at 24 CFR 35.1320(b)(2)(ii)(B)) allow the risk assessor to consider such bare soil to be too small to constitute a hazard.

It is recommended that the risk assessor identify bare soil in the dripline/foundation area of nonresidential outbuildings as well as residential buildings if the following conditions are present:

- ◆ the building is a substantial permanent structure, such as a garage;
- ◆ it was built before 1978;
- ◆ there is evidence that the walls or the roof are or have been painted;
- ◆ it is free-standing and not structurally connected to or part of a residential building; **and**
- ◆ the bare soil is accessible to young children (i.e., access is not effectively blocked by a fence, wall, thorny bushes, etc.).

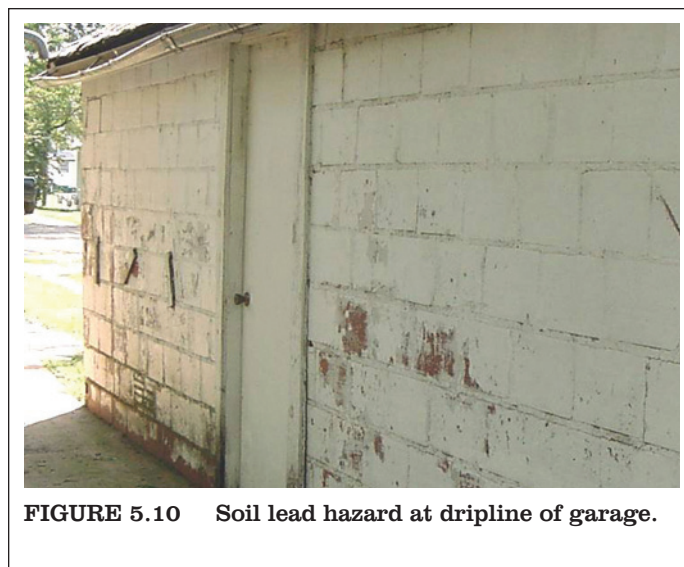


FIGURE 5.10 Soil lead hazard at dripline of garage.

If these conditions do not apply, any bare soil in the dripline/foundation area of an out-building should be considered as part of the soil represented by the rest-of-the-yard sample.

For large properties and mixed-use properties, risk assessors must determine what part of the grounds are “residential,” that is, those grounds that are intended for the service or use of the residents.

Field Report

The field report of the visual assessment of soil should consist of a site plan sketch and Form 5.5, or similar form. These *Guidelines* do not include a separate form for recording the results of the visual assessment of soil. Rather it is recommended that Form 5.5, or similar form, be used to record the findings of the visual assessment as well as the results of soil sampling. As explained in Section II.G.4, below, risk assessors should assign a number to each area to be sampled and enter the numbers on the site-plan sketch and Form 5.5, or similar form.

Identify on the site plan sketch the location of each distinguishable play area with bare soil that is used or may be used by a child of less than six years of age. If the risk assessment covers a property with up to five residential buildings, it is recommended that the risk assessor identify play areas associated with each residential building. For risk assessments of properties with more than five residential buildings, select up to five residential buildings and identify play areas associated with each selected building. To the extent possible, select buildings based on:

- (1) young children in residence, and
- (2) the presence of play areas with bare soil.

If more than five buildings have these characteristics, select five among them randomly.

Identify on the site plan sketch the general locations of bare soil in non-play areas of the dripline/ foundation area(s). If the risk assessment covers a property with up to five residential buildings, it is recommended that the dripline / foundation area of each residential building be examined and associated nonresidential buildings meeting the conditions stated above also. For risk assessments of properties with more than five buildings, identify bare soil in the non-play areas of dripline / foundation areas of five residential buildings. Select five buildings based on the following conditions:

- (1) occupancy by young children, if known;
- (2) presence of bare soil in the dripline/foundation area;
- (3) evidence that the walls or roof are or were painted; and
- (4) accessibility of the bare soil to young children. If these conditions are not present, select buildings randomly.

Identify on the site-plan sketch the general locations of bare soil in non-play areas of the rest of the yard.

If the risk assessment covers a property with one-to-five residential buildings, it is recommended that the rest of the yard of each building be examined. If more than five residential buildings are covered by the risk assessment, select five residential buildings based on the following conditions: (1) presence of bare soil in the rest of the yard, and (2) presence nearby of a possible source of lead contamination, such as a recently painted building. If the residential buildings do not vary significantly by these conditions, select five buildings at random.

E. Dust Sampling

Dust sampling should be conducted before paint chip sampling to preclude contamination of dust that might occur during the collection of paint samples. However, XRF readings may be taken on intact paint before dust sampling, so long as no deteriorated paint is disturbed.

1. Method of Sample Collection

Dust samples must be collected using wet wipes. EPA regulations issued in January 2001 define a wipe sample as "a sample collected by wiping a representative surface of known area, as determined by ASTM E 1728, 'Standard Practice for Field Collection of Settled Dust Samples Using Wipe Sampling Methods for Lead Determination by Atomic Spectrometry Techniques,' or equivalent method, with an acceptable wipe material as defined in ASTM E 1792 (see below), 'Standard Specification for Wipe Sampling Materials for Lead in Surface Dust'" (40 CFR 745.63). In March 2002, EPA issued interpretive guidance stating that the Agency considers wipe sampling materials "equivalent" in performance to ASTM E 1792 acceptable, and that EPA considered to be acceptable wipe materials described in Appendix 13.1 of these *Guidelines* and in the EPA document, "Residential Sampling for Lead: Protocols for Dust and Soil Sampling;" (March 1995, EPA 747-R-95-001 at <http://nepis.epa.gov/Exe/ZyPURL.cgi?Dockey=20012QUZ.txt>).

Thus the recommended protocol for sample collection is either Appendix 13.1 of these *Guidelines*, ASTM Standard Practice E 1728, "Standard Practice for Field Collection of Settled

Dust Samples Using Wipe Sampling Methods for Lead Determination by Atomic Spectrometry Techniques,” or the EPA report, “Residential Sampling for Lead: Protocols for Dust and Soil Sampling,” March 1995, (EPA 747-R-95-001). Figures 5-11a through 5-11f illustrate dust sampling.

Neither EPA nor HUD currently recognizes a standard for collecting and evaluating vacuum samples of dust as a part of a lead-based paint hazard risk assessment. Wipe sampling yields a measure of dust lead loading (in micrograms of lead per square foot or square meter), whereas vacuum sampling can provide a measure of the concentration of lead in the dust (in parts per million or micrograms per gram) as well as loading. Wipe sampling, however, is the required method of dust collection because it is simple, inexpensive, and has been used successfully for a number of years. Research has indicated that wipe-sampling results correlate well with blood lead levels in children (Lanphear, 1996). The protocols in Appendix 13.1 and ASTM Standard Practice E 1728 are comparable to that used in the Lanphear study.

The following considerations should be observed when collecting dust samples:

- ◆ **Disposable, moistened, individual (not bulk-packaged) towelettes are used to collect samples and to clean sampling equipment.** Risk assessors should use a brand of wipes acceptable to the laboratory that will analyze the samples (see Section IV, below, for information on laboratory accreditation). Many laboratories supply wipes to the risk assessor. Important factors to consider in wipe material are as follows:
 - **Durability and size.** Wipes must be of adequate length, width and thickness to perform the collection procedure. A thin wipe of approximately 15 cm x 15 cm is recommended. Wipes must be rugged enough to not tear easily. Whatman™ filters are not recommended for that reason.
 - **Moisture content.** Wipes must be moist to the touch across the entire wipe. If the wipes have dried out (e.g., from a torn wrapped), they should not be used.
 - **Digestibility.** Wipes should not be so thick that they cannot be digested in routine laboratory analysis.
 - **ASTM standard.** The American Society for Testing and Materials International (ASTM) has issued a Standard E 1793, “Standard Specification for Wipe Sampling Materials for Lead in Surface Dust.” The version of the standard current as of the publication of this edition of these *Guidelines* is ASTM E1792 - 03(2011), per <http://www.astm.org/Standards/E1792.htm>. (Check the ASTM website for updates.) The standard includes, among other things, requirements pertaining to thickness, ruggedness, and packaging. Some wipes may be too thick to meet the ASTM standard and may not be packaged according to the standard. If a wipe material has been found to meet the ASTM standard, there is assurance of uniform quality, especially of wetness. The ASTM specifications apply to a specific lot or batch of wipes. Therefore anyone, from manufacturer to user, can conduct the testing needed to verify conformance to the standard.
- ◆ **Field blank samples.** For quality assurance, risk assessors should submit field blank samples to the laboratory at a frequency of at least one blank for each property. For multi-family risk



FIGURE 5.11a Dust sampling equipment.



FIGURE 5.11b Use individually-packaged wipes.



FIGURE 5.11c Making a first (horizontal) pass.



FIGURE 5.11d Folding wipe over for second pass.



FIGURE 5.11e The second (vertical) pass.



FIGURE 5.11f Placing the wipe into a hard sample container.

assessments, one blank should be submitted for every 20 samples collected. Generally, a maximum of ten blanks per property is adequate, but more may be necessary for very large multi-family properties, such as those with more than 500 units.

- ◆ **Spikes** (i.e., wipes with a lead loading known to the risk assessor but not the laboratory) are not required. Laboratories recognized by EPA for lead analysis must participate in a proficiency testing program that includes analysis of single-towelette spiked wipes (see Section IV, below, for information on laboratory accreditation). However, some risk assessors opt to use spikes because they provide additional verification of results.
- ◆ **Hard, resealable containers** (such as screw-top plastic centrifuge tubes, not plastic bags) should be used to transport wipe samples from the sampling site to the lab, since the container will be rinsed to recover all lead in the sample.
- ◆ **Other required equipment including non-powdered, disposable plastic gloves; masking tape; steel or plastic measuring tape or ruler; container labels and permanent marker; and trash bags.** (Non-powdered gloves are recommended because powder on gloves may contaminate the sample.)
- ◆ **Optional equipment includes disposable shoe coverings and reusable templates.** Reusable templates are recommended for ease in obtaining samples of equal area.

2. Selection of Rooms within a Dwelling Unit

Regulatory Requirement

Dust samples must be collected “in all living areas where” young children “are most likely to come into contact with dust” (40 CFR 745.227(d)(5)).

Basic Sampling Plan

These *Guidelines* recommend that risk assessors select a minimum of four rooms for dust sampling (except, of course, when the dwelling unit has less than four rooms).

Note that, for the purposes of risk assessment sampling (as well as lead hazard screen, lead-based paint inspection and clearance sampling), hallways, stairways, entry rooms/lobbies and other significant definable spaces are considered “rooms” as well as spaces normally considered as rooms, such as bedrooms, bathrooms, living rooms, kitchens, dining rooms, family rooms. Similarly, for these sampling purposes, a hallway, lobby or other space within a multi-family building is considered a “unit” or a “room,” as applicable.

This recommendation is based on research on variability in dust-lead loading and error associated with number and location of samples (Dixon, 2004). Risk assessors may, at their discretion, collect samples in more than four rooms. In addition, risk assessors should always collect a floor sample from inside the principal entryway of a dwelling unit that has direct access to the outside. (For units accessed via a common hallway or stair landing, the principal common entryway should be sampled.) Entryways generally had floor dust-lead levels that averaged about 30 percent higher than those of other rooms in the HUD Evaluation of the Lead Hazard Control Grant Program (NCHH, 2004).

The rooms generally recommended for sampling, in approximate order of importance, are:

- ◆ the principal play area of young children,
- ◆ the kitchen,
- ◆ the bedroom of the youngest child,
- ◆ the bedroom of the next oldest child,
- ◆ the bathroom used by the youngest child, and
- ◆ the living room.

Aside from the entryway, these recommendations are only general guidance (see Figure 5.12). Risk assessors should select the rooms in which they think young children are most likely to be exposed to dust-lead hazards. Of course, if a dwelling unit has only four rooms or fewer, all rooms should be sampled, and if a dwelling has only one bedroom, another room must be substituted for the second bedroom. A porch or balcony may be considered a living area if: it is used as a living area, it is not a common area but is for the private use of the residents of the dwelling unit, and it is reasonably protected from the exterior environment.

If young children reside in the dwelling, the risk assessor should be guided in choice of rooms by the information on the locations of high child activity recorded on Form 5.0, or similar form.

If no children under age six are in residence, one can presume that the smaller bedrooms are those that would be used by young children and that the living room or family room would be the principal play area (see figure 5.15). In dwellings where locations of childhood activity must be presumed, greater emphasis should be given to selection of rooms that are likely to have lead contamination, as evidenced by deteriorated paint or recent repainting (research indicates that repainting generates lead dust if the work is not done in a lead-safe manner). Even in dwellings occupied by young children, if a room is likely to be highly contaminated (as evidenced, perhaps, by an unusual amount of deteriorated paint on windows and trim) but has only moderate contact by young children, the risk assessor may be justified in choosing it instead of perhaps a bedroom that appears to be in good condition.

Dust Sampling for Friction-Surface Hazard Determination

Dust testing in rooms other than the rooms selected for the basic sampling procedure described above is necessary only if there is, in one or more of the other rooms, deteriorated or intact paint on a surface that is determined visually to be a friction surface and the paint is known or presumed to be lead-based paint. If this is the situation, dust sampling locations should be selected based on the guidance in Section II.E.3, below, pertaining to dust sampling for friction-surface hazard determination.



FIGURE 5.12 Floor sampling in high traffic area near entry.

3. Selection of Locations within Rooms

Regulatory Requirements

Dust samples must be collected from the interior window sill(s) and floor in all living areas where young children are most likely to come into contact with dust (40 CFR 745.227(d)(5)). For friction-surface hazard determination, dust-lead levels on the nearest horizontal surface underneath the friction surface must be equal to or greater than dust hazard levels (40 CFR 745.227(h)(2)(i)).

Basic Sampling Plan

Building Components. Wipe samples must be collected from floors and interior window sills in each of the rooms selected for basic dust sampling, except only a floor sample is needed in the entryway. The interior window sill is the portion of the horizontal window ledge that is in the interior of the room, adjacent to the window sash when closed; it is technically called the window “stool” (shown in Figure 5.13, and as Area C in Figure 5.14).

The window trough, sometimes called the window well, is the portion of the horizontal window sill that, in the case of a double hung window, receives both the upper and lower window sashes when they are lowered (Area A in Figure 5.14), or, if there is a storm window, the area between the storm window and the interior window sill (Area A plus B in Figure 5.14). Sampling of window troughs is not required by EPA or HUD as part of a risk assessment, and there is no EPA hazard standard for dust-lead in troughs. There is a *clearance* standard for troughs, but not a hazard standard. The reason for this is that while data analyses indicate that dust-lead measurements in both interior window sills and window troughs are significant in predicting children’s blood lead levels, dust-lead levels on sills and troughs are highly correlated. EPA concluded that sampling both sills and troughs instead of just one of the surfaces would not improve a risk assessor’s ability to characterize risk enough to justify the additional cost. The EPA chose interior sills because they are usually easier to sample than troughs and because dust-lead in troughs may result from exterior sources and thus may be less representative of interior conditions than dust-lead on interior window sills. Dust-lead levels in troughs are sometimes extremely high, however, so it is important to include them in a cleanup protocol after hazard

controls, maintenance or renovation. Some States, Indian Tribes, or local governments may require that window troughs be sampled as a part of a risk assessment.

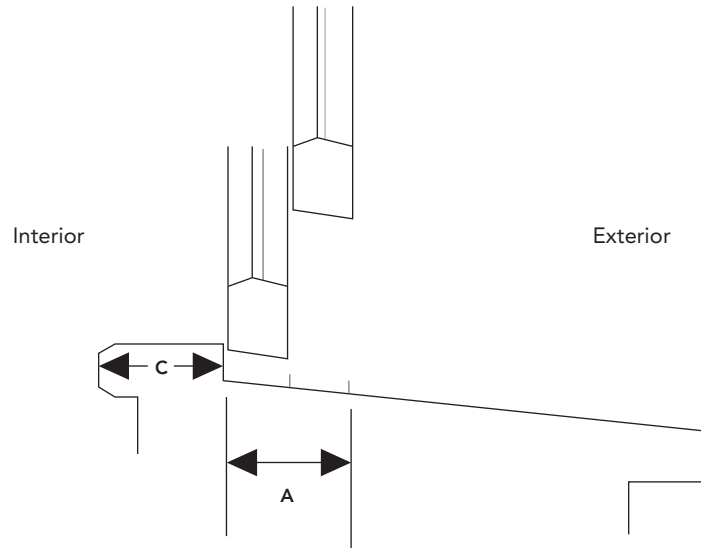
Dust samples may also be collected, at the option of the risk assessor and the client, from other horizontal components, such as window troughs or built-in shelves or cabinets (housing food, dishes, toothbrushes, eating utensils, etc.), but there is no EPA or HUD dust-lead hazard standard for these components.

Choosing Exact Locations on Components. Only general guidance can be offered on exactly where samples should be collected on building components. Factors to be considered in selecting exactly where on floors and interior window sills dust samples should be taken are as follows:

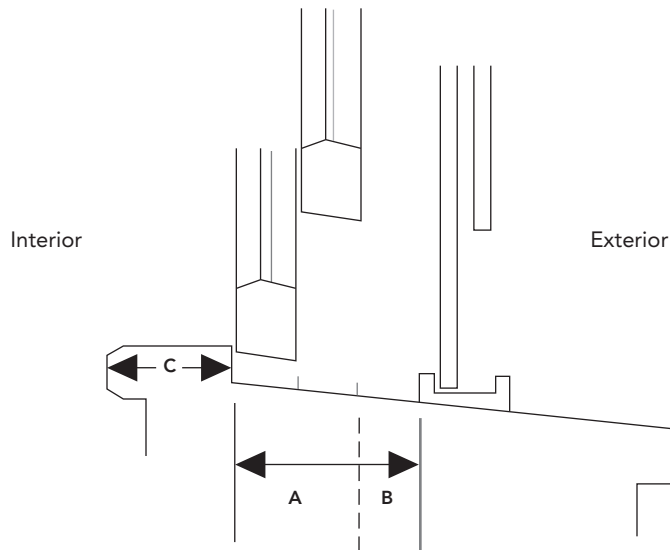


FIGURE 5.13 Window sill (at arrow); trough is behind sill, under sash and in front of storm window tracks.

Figure 5.14 Illustrations of Window Trough and Interior Window Sill



1. Sectional view of window (with no storm window) showing window trough area, A, to be tested. Trough is the surface where both window sashes can touch the sill when lowered. The interior window sill (Stool) is shown as area C. Interior window sills and window troughs should be sampled separately.



2. Sectional view of window (including storm window) showing window trough area, A and B, to be tested. Trough extends out to storm window frame. The interior window sill (stool) is shown as area C. Interior window sills and window troughs should be sampled separately.

Courtesy: Warren Fredman

- (1) **Contact by children.** Floor dust samples should be collected from areas that are likely to be contacted by young children, such as play areas within rooms, high-traffic walkways, room midpoints, or areas immediately underneath windows. Interior window sill dust samples in a given room should be collected from the window that is most frequently contacted by children, if known. For example, if toys are located on one window sill but not the other, the one with the toys should be sampled.
- (2) **Operable windows.** For interior window sill samples, a window that can be opened and closed should be selected, if possible, and windows that are opened frequently are preferable to windows that are seldom operated.
- (3) **Friction surfaces.** If there is a painted friction surface on a window or door, should be collected from the sill or floor sample from the sill or door under that surface.

Risk assessors should combine this general guidance with the data from the visual inspection and any information gathered about the residents' use patterns to determine the exact number and location of dust samples to be collected. For a risk assessment in multi-family housing in which more than one unit is being assessed (vs. a risk assessment of one unit only), these suggestions may be used to assist the risk assessor in developing a sampling plan for each dwelling. An example of a dust sampling plan is shown in Figure 5.15 below.

Dust Sampling for Friction-Surface Hazard Determination

As mentioned above, friction-surface hazard determination is necessary if: (1) there is paint (deteriorated or intact) on a friction surface and (2) the paint is known or presumed to be lead-based paint. A friction-surface hazard in which the paint is known or presumed to be lead-based paint is known or presumed to be a paint-lead hazard, which is a type of lead-based paint hazard. (40 CFR 745. 65(a)(1).)

The risk assessor determines whether the paint is lead-based paint by: (1) reference to a prior lead-based paint inspection or prior paint testing that is considered reliable, or (2) paint testing. If paint testing is necessary, a non-destructive XRF measurement should be taken, if practicable, on the surface in question or elsewhere on the same component in the same room equivalent, in accordance with principles set forth in Chapter 7, *before* deciding whether dust sampling results are needed. Destructive paint chip sampling should not be conducted before dust sampling. If the XRF measurement is positive, or if non-destructive paint testing cannot be performed, or if the owner agrees that paint that is not known to be lead-based paint by previous inspection or testing shall be presumed to be lead-based paint without measurement or testing, the risk assessor should proceed as follows:

Within Rooms That Are Part of the Basic Sampling Plan. Within the rooms selected for floor and interior-window-sill sampling, the risk assessor should proceed as follows in most circumstances:

- ◆ For friction surfaces on windows, use the results of the interior-window-sill dust sample collected in the room in which the subject friction surface is located, provided the dust sample was collected from the sill of an operable window.
- ◆ For friction surfaces associated with doors, use the results of the floor dust sample collected in the room, provided the sample was taken within approximately 3 feet of the subject door. If a floor sample was not taken at that location, collect a floor dust sample within approximately 3 feet of the door.

Figure 5.15 Example of a Basic Dust Sampling Plan

Dust samples should be collected from each of the following locations:

- ◆ One from the floor of the youngest child's principal play area, which is the living room in this example.
- ◆ One from the interior window sill of the most frequently opened window in the living room (the child's principal play area).
- ◆ One from the floor of the kitchen.
- ◆ One from an interior window sill in the kitchen.
- ◆ One from the floor of the bedroom of the youngest child (older than 6 months).
- ◆ One from the interior window sill of the bedroom of the youngest child (older than 6 months).
- ◆ One from the floor of the bedroom of the next oldest child, if any.
- ◆ One from the interior window sill of the bedroom of the next oldest child.
- ◆ One from the floor and window sill of every other room selected by the risk assessor.
- ◆ One from the floor inside the most frequently used door that provides direct access to the outdoors.

If no playroom can be identified, the living room should be sampled. If the youngest child's bedroom cannot be identified, the smallest bedroom should be sampled.

Under this plan, two composite samples plus one single sample from the entryway or nine single-surface samples would be collected. The risk assessor should use professional judgment to determine which method is most appropriate.

In some dwellings, it may be appropriate to add a sample location if, for example, an additional location is identified that displays both a visible accumulation of dust and childhood exposure. A dusty counter or shelf in a child's play area, a dirty window trough containing children's toys, and dish cabinets with deteriorated paint are other possible examples. However, there is no Federal hazard standard for these surfaces.

- ◆ For painted floors or stair treads, use the results of the floor dust sample collected in the room or stairway, provided the sample was taken directly from a painted surface of a like component (i.e., floor or stair tread). If no such sample was taken, collect a dust sample directly from the subject floor or stair-tread surface.
- ◆ For friction surfaces on painted counters and shelves (optional), collect a dust sample directly from the subject surface.

Within Rooms That Are Not Part of the Basic Sampling Plan. Within rooms that were not selected for floor and interior-window-sill sampling as part of the basic sampling plan, the risk assessor should proceed as follows in most circumstances:

- ◆ For friction surfaces on windows, the risk assessor should choose one of the following options:
 - (1) collect a dust sample from the interior window sill of the window with the subject friction surface (only one sill dust sample is needed per room, provided it is from an operable window), or
 - (2) presume the dust is a dust-lead hazard.
- ◆ For friction surfaces associated with doors, the risk assessor should choose one of the following options:
 - (1) collect a dust sample from within 3 feet of the subject door, or
 - (2) presume the dust is a dust-lead hazard, and that the friction surface is a lead-based paint hazard.
- ◆ For painted floors or stair treads, either
 - (1) collect a dust sample directly from the subject surface, or
 - (2) presume the dust is a dust-lead hazard, and that the friction surface is a lead-based paint hazard.
- ◆ For friction surfaces on painted counters and shelves (optional), either
 - (1) collect a dust sample directly from the subject surface, or
 - (2) presume the dust is a dust-lead hazard.

If the dust is known (by analysis for lead by a laboratory recognized by NLLAP for analysis of lead in dust) to be a dust-lead hazard or is presumed to be a dust-lead hazard in the absence of dust-lead analysis, and if the paint is known (by XRF measurement or by analysis for lead by a laboratory recognized by NLLAP for analysis of lead in paint) to be lead-based paint or is presumed to be lead-based paint, the friction surface is known or presumed to be a paint-lead hazard, which is a type of lead-based paint hazard. (40 CFR 745.65(a)(1).)



FIGURE 5.16 Dust testing a window sill to determine the presence of a friction hazard.

4. Composite Dust Sampling

Under EPA and HUD regulations, dust wipe samples may be either single surface or composite. Each single-surface sample is a separate wipe from a specific location. It is placed in a separate container and is analyzed separately. A composite sample can contain up to four wipes from four different locations, but the locations must be from the same type of component, e.g., hard floors from four different rooms, or interior window sills from four different rooms. Wipe samples are composited in the field, not in the laboratory, by inserting up to four wipes from four surfaces into the same container. The laboratory analyzes all four wipes as one sample using a modified analytical procedure. The individual wipes in each composite are called “subsamples.”

Background: Acceptable recovery rates (i.e., within the range of 80 to 120 percent of the “true” value) have been found when no more than four wipes are analyzed as a single sample (EPA, 2001b; Jacobs, 1993c). Testing reported in 2011 among multiple NLLAP-recognized laboratories identified two sample preparation methods for four-wipe composite dust wipe samples that are capable of meeting NLLAP requirements for accuracy (recovery) and precision. (White, 2011)

Research has shown the benefit of composite dust wipe testing for the case of high-dust jobs involving lead-based paint. (Cox, 2011) For such jobs, lead in dust next to the walls was three times more difficult to clean than lead in dust nearer the center of the rooms; clearance using single-wipe samples collected next to the walls was much more likely to fail; and “four-wipe composite sampling within each room (two randomly selected from the perimeter and two randomly selected from the interior) provided a very reliable method for detecting clearance failure (99% or greater) versus a randomly selected single wipe sample per room (50% or less).”

In 2011, the American Industrial Hygiene Association Laboratory Accreditation Programs, LLC revised the “Specific Additional Requirements” in Policy Module 2C for its Environmental Lead Laboratory Accreditation Program (ELLAP). Laboratories accredited by ELLAP for lead analysis of dust wipes are recognized by NLLAP (and similarly for lead in paint chips and soil). As of the publication of these *Guidelines*, the ELLAP policy covers accreditation (and, hence NLLAP recognition) of laboratories analyzing composited wipes, for which “all requirements for wipes listed in Policy Module 2C apply, but with the additional requirement that each batch of samples and associated QC samples shall contain the same number of wipes, i.e. composited samples that contain two wipes are to be analyzed in a batch containing QC samples to which two wipes were added as matrix.” (ELLAP policy 2C.4.12, which is linked from <http://www.aihaaccreditedlabs.org/PolicyModules/Pages/2011%20Policy%20Modules.aspx>. Additional composite-specific requirements are found in the ELLAP application form linked from <http://www.aihaaccreditedlabs.org/programfees-guidelines-forms/Pages/default.aspx>.)

Single-surface sampling should be used on surfaces that are unique in some way. When they are used, composite samples should be taken on surfaces all of which are fairly similar. For example, if there is a single interior window sill in a child’s play area that serves as a storage space for toys, then it should not be sampled by a composite sample, since information is needed about that specific location. Samples collected for the purpose of determining whether a specific friction surface is a hazard must be single-surface samples. The selection of composite or single-surface sampling is a professional judgment that should be made only by a certified risk assessor.

Recommendations: While these *Guidelines* recognize the use of composite sampling of dust, they generally do not encourage it for the following reasons:

- ◆ Most laboratories that are recognized by EPA (i.e., NLLAP accredited laboratories) for analysis of lead in dust discourage clients from submitting composite dust-wipe samples,
 - There is no program to confirm the proficiency of laboratories in analyzing composites. The lack of a proficiency program for composites may make the data less convincing in case of a dispute.
 - Compositing offers only limited information about individual rooms. Single-surface sampling provides specific information that may help focus hazard control efforts on particular surfaces and make hazard control more cost effective by limiting its scope to specific rooms. **Composite sampling does not identify the specific room or location but instead represents a series of rooms/locations; accordingly, it could be more costly to clean such larger areas than the fewer, smaller areas represented by having collected single surface samples.**
 - Laboratories often separate composite samples and analyze each wipe separately because their equipment and sample preparation procedures are set up for individual wipes, rather than analyzing the composited samples together. As a result, the cost of the composite analysis may well be at least as high as for analyzing the wipes submitted as separate samples.
 - The cost of single-surface sampling has declined since the 1990s, so the money spent in single-surface samples is more than made up by having good data.

If composite sampling is used, a minimum of two separate composite dust samples should be collected: one for floors and one for interior window sills. A third sample would be needed if carpets are sampled as well as hard floors. In addition, a wipe sample should be collected from the floor of the entry inside the most frequently used door to the exterior. This sample is usually collected as a single-surface sample, but it may be included as a fourth subsample in the floor composite sample if the dwelling unit has no more than three rooms (composites should contain no more than four subsamples). If the risk assessor wishes to sample window troughs, counters, shelves and other horizontal surfaces; additional composite or single-surface samples must be taken for these components. However, the risk assessor should recall that no Federal hazard standard exists for components other than floors and interior window sills.

The following recommendations should be observed if composite dust wipe sampling is conducted:

- ◆ Risk assessors should follow either Appendix 13.1 of these *Guidelines*, or *ASTM Standard Practice E 1728 for collection of wipe subsamples*.
- ◆ Wipes used for composite dust wipe samples should meet the requirements of ASTM Standard E 1792 or Appendix 13.1 of these *Guidelines*.
- ◆ Whenever composite sampling is contemplated, risk assessors should check with the analytical laboratory to determine whether it analyzes composite samples and, if so, whether special quality assurance practices are needed. Laboratories should be able to

analyze composite samples with wipes that meet ASTM Standard E 1792 (Battelle, 2002).

- ◆ Separate composite samples are required from each different component sampled (e.g., a single composite sample should not contain subsamples from both floors and interior window sills, or bare floors and carpeted floors). One reason for this is that methods of controlling dust-lead hazards in carpets are different than for hard floors, so information is needed for each type of floor surface.
- ◆ Separate composite samples are required for each dwelling.
- ◆ The surface areas of subsamples within a composite sample must be approximately the same size in order to avoid over sampling a room. If both composite and single-surface samples are used to represent a component type in the same dwelling unit or common area, the area of each single-surface sample must be approximately the same as that of the subsamples. This is because the determination of whether a dust-lead hazard is present is based on the weighted arithmetic mean of all single-surface and composite samples (see Section V.A.1, below, on interpreting the results of dust sampling). Floor surface areas sampled in each room should be approximately 1 square foot. Interior window sill sample areas are dependent on window characteristics but must be similar from room to room.
- ◆ All the wipe areas for a composite sample should be outlined (with painter's tape or a measured square or rectangular template) before starting to perform the wiping for any of the subsamples. After preparing the container for a composite sample (usually a screw-top centrifuge tube), put on the glove(s) and complete the wiping procedures for all subsamples.
- ◆ A new wipe should always be used for each spot sampled.
- ◆ Carefully insert each wipe subsample into separately identified containers to be composited by the laboratory, or into a properly identified single container.
- ◆ No more than four different wipes should be inserted into a single container for a composite sample.
- ◆ Record a separate measurement for each area that is subsampled on the field collection form (see Form 5.4a). Ensure that the container is properly labeled.
- ◆ Composite samples should not be taken from rooms that have dramatically different conditions. For example, if the clearance examiner has some reason to believe that cleanup was not performed adequately in a room, a single-surface sample should be collected there. In some cases both single-surface samples and composite samples may be needed for the same component.

5. Common Areas (Multi-family Housing Only)

Common areas may include entryways, lobby areas, hallways, stairways, mail rooms, office waiting rooms, common laundry rooms, multi-purpose rooms, childcare facilities, and other spaces intended for use by residents. EPA regulations require a dust sample from the floor and an interior window sill (if present) in: (1) each common area adjacent to each sampled

dwelling unit (usually a hallway or a stairway landing) and (2) other common areas in which the risk assessor thinks a child under six will “come in contact with dust” (40 CFR 745.227(d) (6)). In addition, these *Guidelines* specifically recommend collecting a floor sample inside the main entryway of each building.

It is generally not necessary to collect samples from hallways or stairways other than those adjacent to sampled dwellings. (When owners of multi-family target housing that is *not* receiving federal housing assistance want to characterize lead-based paint hazards in common areas, such as for developing portions of their ongoing maintenance plan or lead hazard control plan specific to those common areas, they may collect samples from all hallways, stairways or other common areas, use the targeted or worst-case methods described in Section III.B.1 of this chapter, or the random sampling protocol in Chapter 7, treating each type of common area as if it were a set of dwelling units for purposes of using Table 7.3. Owners of multi-family target housing receiving federal housing assistance must comply with the risk assessment requirements for the work given by HUD’s Lead Safe Housing Rule, specifically, 24 CFR 35, subpart J, even if all of the work is to be done in common areas.) With regard to identifying other common areas for sampling, risk assessors should, before beginning the visual assessment, obtain from the owner a list of all common areas and the owner’s opinion regarding the frequency with which children under age six visit such areas. Form 5.6 provides space to record this information. In addition, the risk assessor should observe all the common areas during the visual assessment, determine whether there is any evidence of childhood use of each area, and, based on the owner’s opinion and the risk assessor’s observation, decide whether to include the area in the risk assessment.

Friction surfaces in common areas should be assessed in a manner similar to that for dwelling units.

Dust samples may be either single-surface or composite, but, as explained above in Section II.E.4, compositing is not encouraged.

6. On-site Dust Analysis

EPA and HUD allow on-site analysis of dust samples as long as the laboratory analyzing the samples is recognized for on-site (“mobile”) analysis of lead in dust by EPA under the National Lead Laboratory Accreditation Program (NLLAP). Methods exist for reliably screening wipe samples on-site rather than in a fixed laboratory; note that this preliminary screening is not the same as clearance, but may be used by the owner, contractor or clearance examiner as part of determining whether to proceed to clearance testing. These include portable X-ray fluorescence (XRF) analysis and anodic stripping voltammetry (ASV) (Ashley 2001; EPA, 2002b; Clark, 2002). These methods may provide testing results much more quickly than fixed laboratory analysis, and so they may save time and money, reduce relocation difficulties, facilitate cooperation by both landlords and tenants, and accelerate environmental investigations in cases of children with elevated blood-lead levels.

In states and tribal lands where EPA is operating a lead program, wipe samples for a risk assessment must be analyzed by a laboratory or testing firm recognized by EPA under the National Lead Laboratory Accreditation Program (NLLAP) for analysis of lead in dust. If, in these states, an NLLAP-recognized laboratory wishes to perform on-site analyses of dust wipe samples, it may do so if its NLLAP recognition includes the type of laboratory operation to be used, whether a

mobile laboratory, or a field sampling and measurement organization. See the NLLAP Laboratory Quality System Requirements (LQSR). (As of the publication of this edition of these Guidelines, NLLAP was using Revision 3.0 of the LSQR, dated November 5, 2007. <http://www.epa.gov/lead/pubs/lqsr3.pdf>, especially pages 1-2, 7, 12, and 18-19.) In states or tribal lands where the state or tribe is operating an EPA-authorized lead program, the same requirements generally apply, although there may be some differences. While EPA clearance regulations and program procedures apply only to abatement activities (and the option for clearance in projects covered by the RRP Rule), HUD regulations and many State regulations apply the same procedures to non-abatement activities. On-site analysis (just like fixed-site laboratory analysis) of dust for lead for risk assessment or lead hazard screening of target housing may only be done by an NLLAP-recognized laboratory. Thus a certified risk assessor, lead-based paint inspector, or sampling technician who wishes to conduct on-site dust testing as part of a risk assessment must conduct the analysis as part of working for an NLLAP-recognized laboratory, whether as an employee or a subcontractor of the laboratory.

F. Paint Testing in Risk Assessment

The risk assessor must determine whether the following surfaces contain lead-based paint: all surfaces with deteriorated paint (both interior and exterior), surfaces with intact paint on friction surfaces, and chewable surfaces with evidence of teeth marks. All of these surfaces should be identified on the visual assessment field report (Form 5.2, or similar form).

The risk assessor may make the lead-based paint determination from the results of a complete lead-based paint inspection, as described in Chapter 7, or from the testing of specific surfaces, following the principles of Chapter 7. Nondestructive paint testing (as with an XRF) may be performed before dust sampling, but destructive paint testing (as with paint chip sampling) must be performed after dust sampling in order not to disturb the dust on the surface before it is sampled.

1. Evaluating Previous Paint Testing

If previous testing of lead-based paint has been completed, the risk assessor should review the testing report to determine if the results are reliable. Past inspections, especially those conducted before lead-based paint inspectors were required to be certified, may not conform to current standards of care and may not have accounted for important sources of error, possibly resulting in an incorrect determination of the location of lead-based paint.

The risk assessor should review the previous report using the checklist shown in Table 5.5. Chapter 7 contains detailed instructions on how repeated paint inspections can be completed.

If the answer to any of the Table 5.5 questions is negative, the past inspection or a portion of that inspection may not be reliable. (Note that older inspections may have been conducted before EPA issued its rule requiring that lead-based paint inspectors inspecting target housing be certified (61 *Federal Register* 45777, August 29, 1996), or before EPA established the NLLAP (59 *Federal Register*, September 28, 1994).) All surfaces with questionable readings should be treated as though they were never tested. If the inspection report will be used to make decisions in the future, the owner should be encouraged to retest all of the surfaces where the results are questionable.

If Table 5.5 indicates that paint testing was adequate, the risk assessor can use the previous results without additional testing.

Table 5.5 Review of Previous Lead-Based Paint Inspections.

	Question	Yes	No
1	Did the report clearly explain the entire testing program and include an executive summary in narrative form?		
2	Was the inspection conducted by an EPA- or State-/Tribal-certified lead-based paint inspector?		
3	Was any laboratory that analyzed paint samples for lead recognized by the EPA's National Lead Laboratory Accreditation Program (NLLAP) for analysis of lead in paint?		
4	Did the report provide an itemized list of similar building components (testing combinations) and, if the inspection was of a multi-family property, the percentage of each component that tested positive, negative, and inconclusive using XRF? (Percentages are not applicable for single-family dwellings.)		
5	Did the report include test results for the common areas and building exteriors as well as the interior of the dwelling units?		
6	Were all of the painted surfaces that are known to exist in the dwelling units, common areas, and building exteriors included in the itemized list of components that were tested?		
7	If confirmation testing (laboratory paint chip testing) was necessary, did the testing or inspection firm amend the final report and revise the list of surfaces that tested positive, negative, and inconclusive?		
8	Was the unit selection process performed randomly in multi-family properties, and was the correct minimum number of dwelling units sampled and inspected?		
9	Is the name of the XRF manufacturer and the model, serial numbers of the XRF that was used in each unit recorded in the report?		
10	Did the report record the XRF calibration checks for each day that testing was performed?		
11	Did the XRF calibration checks indicate that the instrument was operating within the Quality Control Value? (see Chapter 7)		
12	Were the required number of XRF readings collected for each surface?		
13	Were XRF substrate corrections performed (if necessary)?		
14	Were confirmatory paint chip samples collected if XRF readings were in the inconclusive range for the instrument and mode used?		
15	Was the procedure that was used to collect the paint chip samples described?		
16	Was the laboratory that analyzed the paint chip samples identified?		

2. Paint Testing Methods

Paint testing can be performed with either a portable XRF lead-based paint analyzer or by laboratory analysis of paint chip samples, and, in certain cases, chemical test kits (also known as spot test kits). Whichever method is used, the paint surface tested should not be worn, since some of the lead-containing layer(s) may have worn away. Usually, thicker sections of paint film, as determined visually, should be analyzed to determine the presence of lead-based paint.

Portable XRF Analysis

Portable XRF analyzers should be used on surfaces with intact paint areas large enough to completely cover the active emission/detector window on the XRF face. Furthermore, the surface against the emission/detector window on the XRF face should be flat or nearly flat so that little curvature of the paint surface exists against this window. These are the conditions under which XRFs are calibrated, and therefore they are the conditions under which reliable readings can be obtained. Therefore a portable XRF can be used to obtain a reliable and conclusive measurement of lead in a deteriorated painted surface only if an area of intact paint nearby on the same component can be used for XRF analysis – a situation that is not uncommon.

If, however, a portable XRF reading *is* taken of a paint surface in a manner that does not meet the conditions described in the previous paragraph, the reading, in milligrams of lead per square centimeter (mg/cm^2), is likely to be less than the true value. This is because either the distance from the detector to at least some levels of paint will be greater than the distance used in calibration or the area of paint surface from which energy is emitted from the surface in the direction of the detector will be less than that used in calibration. Therefore, under such conditions, if the reading is equal to or greater than the applicable definition of lead-based paint in mg/cm^2 , the risk assessor may presume that the paint surface contains lead-based paint. On the other hand, if the reading is less than the applicable standard, one cannot conclude that the paint surface does not contain lead-based paint; laboratory analysis of a paint chip sample should be conducted.

More information on XRF testing can be found in Chapter 7.

Paint Chip Sample Collection and Analysis

Paint chip samples for laboratory analysis are collected by removing *all* layers of paint from a measured surface area without removing any substrate. It is important to collect *all* layers of paint from a sample location, not just the peeling layers. All layers of paint should be included in the sample for the following reasons: (1) All layers may be removed during the scraping involved in preparing the surface for repainting (repair process); and (2) the result of the paint chip analysis should be comparable to an XRF reading, which reads all layers. It takes practice to collect a paint chip sample properly. A complete protocol for sampling paint (intact, as well as deteriorated paint) can be found in Chapter 7 and Appendix 13.2. Also recommended is ASTM Standard Practice E 1729, “Standard Practice for Field Collection of Dried Paint Samples for Lead Determination by Atomic Spectrometry Techniques” (can be accessed at <http://www.astm.org/Standards/E1729.htm>). Minor cleanup of the immediate area should be done with wet wipes following any destructive paint chip sampling effort (see Figure 5.17). Lead-based paint inspectors and risk assessors

are not generally responsible for repainting, unless specified in their contracts; owners and property managers are usually responsible for repainting.

Composite Paint Chip Sampling

Composite paint chip sampling, a rare practice, is not recommended. It decreases the information provided to the risk assessor and owner about the presence and location of lead-based paint in the housing, and is not cost effective.

Chemical test kits

Chemical test kits, also known as spot test kits, are intended to show a color change when a part of the kit makes contact with the lead in lead-based paint. Because of how long it has been since the application of lead-based paint in residential units was banned, often the surface coat does not contain significant levels of lead. Therefore many spot test kits require exposing all the layers of paint by slicing or some other method.

One type of chemical test kit is based on the formation of lead sulfide, which is black, when lead in paint reacts with sodium sulfide. Another is based on the formation of a red or pink color when lead in paint reacts with sodium rhodizonate. (For more technical and regulatory information on test kits, see Chapter 7, Section I.H.2.)

As of the publication of this edition of these *Guidelines*, a chemical test kit for lead can be recognized by the EPA (see the list at <http://www.epa.gov/lead/pubs/testkit.htm> to determine, for RRP Rule use, that lead-based paint is not present if the test kit meets the EPA's negative response criterion (40 CFR 745.88(b)(4) and (c)). Specifically, when a certified renovator obtains a negative response from an EPA-recognized test kit, i.e., indicating that lead-based paint is not detected, the certified renovator may use the response to determine whether the renovation project is exempt from the RRP Rule. Similarly, when a certified inspector or risk assessor obtains a negative response from an EPA-recognized test kit – but not a positive response – the response may be included in a lead-based paint inspection, hazard screen or risk assessment report. (These individuals need not be working for a laboratory recognized by NLLAP for analysis of lead in dust.)

3. Surfaces to Be Tested

Deteriorated Paint

One paint chip sample or XRF reading should be collected from all similar building components with deteriorated paint within each room equivalent on the exterior as well as the interior of the dwelling or common area. For example, if all 4 walls in a room have deteriorated paint, each of the walls must be tested, not just one wall. It is recommended that XRF testing be used where feasible in order to reduce the amount of paint chip sampling.



FIGURE 5.17 Damage to painted surface caused by paint chip sampling.

Chewed Surfaces

Surfaces found in the visual assessment to have been chewed (by virtue of evidence of teeth marks) should be tested if a child of less than six years of age resides in or regularly visits the site. Chewed surfaces could include interior window sills, balusters, shelves, stairs, and other surfaces accessible to children's mouths. Paint surfaces that display teeth marks should be analyzed either by paint chip analysis or XRF testing. If no testing occurs, the surface should be presumed to be a lead-based paint hazard, and should be treated accordingly.

Intact Paint on Friction Surfaces

The risk assessor should test intact paint on friction surfaces identified in the visual assessment, following principles described in Chapter 7.

Surfaces to be Disturbed by Rehabilitation or Maintenance

Generally, risk assessors do not test intact paint for lead content. However, if certain areas of intact paint are expected to be disturbed in the future due to rehabilitation, renovation, maintenance, or other work **that may disturb the paint**, the paint in those areas should be analyzed by XRF testing or paint chip analysis. The HUD Lead Safe Housing Rule requires that painted surfaces in HUD-assisted target housing that are to be disturbed or replaced during Federally assisted rehabilitation must be tested for lead or presumed to be lead-based paint (24 CFR 35.930) (see Appendix 6). Both EPA's RRP Rule and HUD's Lead Safe Housing Rule do not apply to target housing where a certified lead-based paint inspector or risk assessor has determined that the components affected by the renovation are free of regulated lead-based paint or that a property is free of lead-based paint for the purposes of the Lead Disclosure Rule.

The risk assessor may use the "Notes" column on the right side of Form 5.2 to indicate the existence of a surface to be disturbed, or he or she may use a separate list provided by the client. The advantage of using Form 5.2 is that all surfaces requiring paint testing are shown on the same form. See Appendix 8.1, Sample Pre-Rehabilitation Risk Assessment and Limited Paint Testing Report.



FIGURE 5.18 Baby's bed exhibiting deteriorated paint and evidence of teeth marks.

Paint on Old Furniture (Optional)

HUD considers deteriorated lead-based paint on furniture (not built-in) to constitute a lead hazard and risk to young children. It is the responsibility of the owner of the furniture to resolve those hazards (see Figure 5.18). A risk assessor should strongly recommend to dwelling owners that any furniture with deteriorated paint be analyzed. In rental dwellings, deteriorated paint from resident-owned furniture need not be sampled, since the building owner does not own the furniture and cannot control its correction if a hazard is found. However, the risk assessor should suggest to property owners that it may be in their best interest (as well as the interests of the residents) to identify all lead-based paint hazards. In some cases, the residents themselves may agree to pay for an analysis of their furniture. Whoever pays for the analysis, it must be

clear that the responsibility for treatment or removal of any resident-owned furniture rests with the resident. When no paint samples are collected, the risk assessor should still record the presence of deteriorated paint on old furniture in the final report.

4. Field Report of Paint Testing

If XRF results have been obtained, enter these testing results directly on Form 5.2, or similar form, in the "Paint Testing Results" column. Enter results of previous paint testing in the same column. For paint chip sampling, use Form 5.3, or similar form, but also enter the sample number in the "Paint Testing Results" column of Form 5.2 to establish a cross reference to the field sampling form (i.e., Form 5.3). This aids in confirming that all surfaces requiring paint testing have been tested.

G. Soil Sampling

The risk assessor should determine whether the soil outside of a dwelling poses a significant hazard to children. To accomplish this, it will be necessary to determine not only the concentration of lead in the soil, but also the use pattern (i.e., the frequency of contact and use of soil) for different soil locations and conditions. Since only areas of bare soil are considered potential lead-based paint hazards under EPA regulations, the risk assessor should sample only areas of bare soil unless otherwise requested. (See the definition of "bare soil" in the Glossary.)

1. Sample Locations

Bare soil areas to be sampled for lead contamination are:

- ◆ Each play area with bare soil, including sandboxes. (See the definition of "play area" in the Glossary.)
- ◆ Non-play areas in dripline/foundation areas. (See the definition of "dripline/foundation area" in the Glossary.)
- ◆ Non-play areas in the rest of the yard, including, but not limited to vegetable gardens, pet sleeping areas, and bare pathways.
- ◆ Vegetable gardens (recommended).

Risk assessors areas should be sure to check unusual areas, such as those beneath elevated porches, to see if they have bare soil and if there is evidence that the areas have frequent soil contact by children of less than 6 years of age, i.e., are play areas.

A property owner may wish to have additional sites sampled if the ground covering on those sites may be disturbed in the future (e.g., by gardening or excavation). As explained in Section II.G.7, above, while EPA regulations require sampling of bare soil in only two types of areas, (1) play areas and (2) non-play areas in the rest of the yard, these *Guidelines* recommend an additional separate sampling of non-play areas in the dripline/foundation area because research has found that average soil lead concentrations are significantly higher there than in other parts of the yard. It should also be noted that EPA regulations state (at 40 CFR 745.227(h)(4)(ii)) that determinations of the presence of soil lead hazards in non-play areas of the yard must be made for each residential building on a property. Sampling plans for different types of properties are discussed below in Section II.G.3, on "Number of Samples."

As explained in Section II.G.7, above, sampling of non-play areas of the yard is not necessary if bare soil totals no more 9 sq. ft. (but this flexibility may not apply in some states). If there is no bare soil, soil sampling is not necessary.

2. Sample Collection Method

Soil samples must be composite samples. Samples may be collected with either a coring tool or a scooping technique using a spoon or lip of a sample container. Coring tools may not be workable in sandy, dry, or friable soil. The top 5/8 inch (1.5 cm) of soil should be collected.

Samples should be collected in accordance with Appendix 13.3, or ASTM Standard Practice E 1727, "Standard Practice for Field Collection of Soil Samples for Lead Determination by Atomic Spectrometry Techniques," or the EPA report, "Residential Sampling for Lead: Protocols for Dust and Soil Sampling," March 1995 (EPA 747-R-95-001). A copy of the ASTM standard can be obtained for a fee by calling ASTM Customer Services at (610) 832-9582 or by fax at (610) 832-9355; or from <http://www.astm.org/Standards/E1727.htm>.

Each composite sample should consist of subsamples that are of approximately equal bulk and that are collected from 3-10 distinct locations. Subsamples should be collected at least 2-6 feet away from each other if possible (small play areas may not be large enough for this spacing).

For non-play areas in both the dripline/foundation area and the rest of the yard, subsamples should be taken from bare soil locations and should be dispersed in a pattern roughly similar to the distribution of the surfaces of bare-soil area throughout the dripline/foundation area and the rest of the yard.

If paint chips are present in the soil, they should be included as part of the soil sample. However, there should be no special attempt to over-sample paint chips. The laboratory should be instructed to disaggregate ("break up") paint chips by forcing them through a sieve in the laboratory. Although paint chips should not be oversampled, they should also not be excluded from the soil sample, since they are part of the soil matrix.

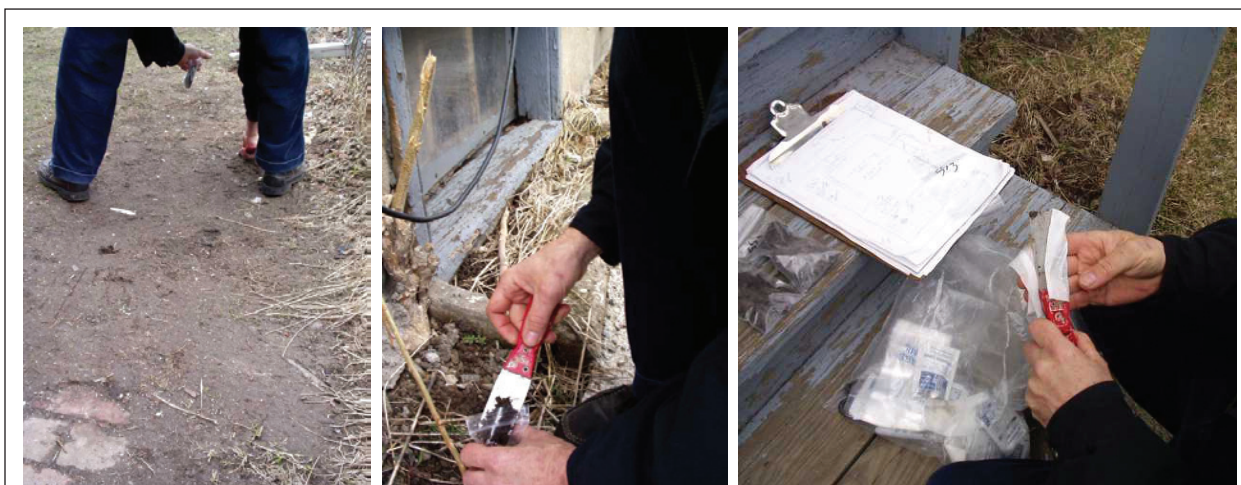


FIGURE 5.19a,b,c Soil Sampling

For sampling vegetable gardens, 6–12 subsamples should be collected, depending on the size of the garden. Samples should be collected to a depth of 3 to 4 inches to account for previous soil mixing. Samples should be evenly spaced and collected using an “X” or zigzag pattern using a coring tool or trowel. Samples should be mixed in a clean plastic container and approximately one cup of soil removed for lead analysis (Rosen, 2002).

Submit samples to the laboratory using the sample submittal form (also known as a chain-of-custody form) provided by the laboratory.

3. Number of Samples

Play Areas

EPA has interpreted the regulatory definition of a soil lead hazard (at 40 CFR 745.65(c)) as requiring that one composite sample must be collected from *each* play area with bare soil. While most residential properties probably have no more than one or two play areas with bare soil, some may have many more than that. This is especially true of large multi-family projects. At some point, sampling of additional play areas provides minimal benefit to the risk assessment. Therefore these *Guidelines* offer the following general guidance on the number of play areas to sample. If there are multiple play areas with bare soil, select those that appear to have the greatest use by young children. The selected play areas will represent all play areas associated with the building.

- ◆ If the risk assessment covers a single residential building (i.e., a building containing dwelling units):
 - If the building has no more than 10 dwelling units, select no more than 2 play areas for sampling.
 - If the building has more than 10 dwelling units, select no more than 3 play areas for sampling.
- ◆ If the risk assessment covers between 2 and 5 residential buildings, sample play areas associated with all residential buildings, with the number of play areas per building (2 or 3) determined by the number of dwelling units in each individual building, as discussed above.
- ◆ If the risk assessment covers more than 5 residential buildings, select 5 of the buildings for sampling.
 - To the extent possible, select buildings based on: (1) residence by young children, if known, and (2) the presence of play areas with bare soil.
 - If more than 5 buildings have these characteristics, randomly select 5 of them.
 - Select play areas associated with, or used by residents of, each selected building in the same manner as described above for an individual building. Do not double-sample play areas associated with more than one residential building.
 - This guidance, which is summarized in Table 5.6, is considered general guidance only. Risk assessors should exercise professional judgment, especially when assessing very large buildings or large multi-building properties.

Table 5.6 Recommended Number of Play Areas To Be Sampled.

Number of Residential Buildings Covered by Risk Assessment	Number of Dwelling Units Per Residential Building	Recommended Number of Play Areas to be Sampled
1-5	1-10	No more than 2 per building
	More than 10	No more than 3 per building
More than 5	1-10	No more than 10 (2 per building x 5 selected buildings)
	More than 10	No more than 15 (3 per building x 5 selected buildings)

Non-play Areas in Dripline/Foundation Area

For bare soil in non-play areas in the dripline/ foundation area, an important question is whether samples should be collected in the dripline/foundation areas of nonresidential outbuildings on the property as well as residential buildings. It is recommended that the risk assessor sample bare soil in the dripline/foundation area of a nonresidential outbuilding if the following conditions are present:

- (1) the building is a substantial permanent structure, such as a garage;
- (2) it is known to have been built before 1978, or its year of construction is not known and there is no reason to presume that it was built more recently;
- (3) there is evidence that the walls or the roof are or have been painted;
- (4) it is free-standing and not structurally connected or part of a residential building; and
- (5) the bare soil is accessible to young children (i.e., access is not effectively blocked by a fence, wall, thorny bushes, etc.).

If these conditions do not apply, any bare soil in the dripline/foundation area of an outbuilding should be considered as part of the soil represented by the rest-of-the-yard sample.

Collect one composite sample of bare soil in the dripline/foundation area of each residential building, if the property covered by the risk assessment contains 1-5 residential buildings. Also collect one sample for each nonresidential building that meets the criteria described above. For very large buildings, the risk assessor may decide to collect more than one sample per building.

If more than five residential buildings are covered by the risk assessment, select five residential buildings for sampling. Select five buildings based on the following conditions:

- (1) occupancy by young children, if known;
- (2) presence of bare soil in the dripline/foundation area;
- (3) evidence that the walls or roof are or were painted; and
- (4) accessibility of the bare soil to young children.

If these conditions are not present, select buildings randomly. Collect one composite sample of bare soil, if any, in the dripline/foundation area of each selected residential building plus one sample from each nonresidential building that is associated with the selected residential building and that meets the criteria for dripline sampling described above for nonresidential buildings. (For very large buildings the risk assessor may collect more than one sample.) Do not double-sample nonresidential buildings associated with more than one residential building. Table 5.7 provides a summary of this guidance.

Table 5.7 Recommended Number of Soil Samples in Non-play Areas of Dripline/Foundation Areas.

Number of Residential Buildings Covered by Risk Assessment	Number of Dwelling Units Per Residential Building	Recommended Number of Dripline/Foundation Area Samples to Collect if Bare Soil is Present*
1-5	(not relevant)	No more than 1 per residential building + 1 per nonresidential building, if any
More than 5	(not relevant)	No more than 1 for each of 5 selected residential buildings + 1 per nonresidential building, if any, associated with each selected residential building

* For very large buildings, the risk assessor may collect more than one sample for each such building.

Non-play Areas in the Rest of the Yard

For bare soil in non-play areas in the rest of the yard, collect one composite sample per residential building. The risk assessor may collect more than one sample for very large yards. If more than five residential buildings are covered by the risk assessment, select five residential buildings based on the following conditions: (1) presence of bare soil in the rest of the yard, and (2) presence nearby of a possible source of lead contamination, such as a recently painted building, or a **heavily used thoroughfare, roadway or industrial facility that uses or emit lead**. If the residential buildings do not vary significantly by these conditions, select five buildings at random. Collect one composite sample of bare soil in the rest of the yard of each selected building. Table 5.8 provides a summary of this guidance.

Table 5.8 Recommended Number of Soil Samples in Non-play Areas of the Rest of the Yard Outside of Dripline/Foundation Areas.

Number of Residential Buildings Covered by Risk Assessment	Number of Dwelling Units Per Residential Building	Recommended Maximum Number of Rest-of-the-Yard Samples to Collect if Bare Soil is Present*
1-5	(not relevant)	No more than 1 per building
More than 5	(not relevant)	No more than 5 (1 per residential building x 5 selected buildings)

* For very large yards, the risk assessor may collect more than one sample per residential building.

4. Field Report

Use a separate Form 5.5, or similar form, for each residential building sampled. Indicate locations on the site plan sketch used in the visual assessment. If the property covered by the risk assessment includes more than five residential buildings, indicate the five buildings selected for sampling on the site plan sketch. On Form 5.5, or similar form, record the location of each composite sample, the approximate area of bare soil represented by the sample in square feet, and the sample number. Sample numbers should also be indicated on the site-plan sketch in order that users will be able to unambiguously identify the location of samples listed on the form. Recording the approximate area of bare soil in each sample facilitates the work write up if soil hazard controls must be conducted.

H. Water Sampling (Optional)

Water sampling is not required for a routine risk assessment, but may be requested by the property owner. Local water authorities are already mandated by the EPA to monitor the lead levels of the water they supply. If the owner is concerned that lead may be leaching into the water between the service line and the faucet, samples can be collected and analyzed.

It is important to recognize, however, that the EPA-recommended protocol for determining whether a specific faucet is a contributor of lead is not the same as that used to test the water supply. See the EPA manual, "Lead in Drinking Water in Schools and Non-Residential Buildings," April 1994 (EPA 812-B-94-002) (<http://nepis.epa.gov/Exe/ZyPURL.cgi?Dockey=20013NC6.txt>). Another EPA publication is "Sampling Lead in Drinking Water in Nursery Schools and Day Care Facilities, April 1994 (EPA 812/B-94-003) (http://www.epa.gov/safewater/lcrmr/pdfs/guidance_lcmr_sampling_nursery_day_care.pdf). The water supplier may be able to offer information or assistance with such testing. It will probably be necessary to find a laboratory certified in the state to analyze lead in drinking water samples and proceed as the laboratory recommends. Assistance may

also be available from the EPA Safe Drinking Water Hotline (800-426-4791) or the National Lead Information Center (800-424-LEAD). (Hearing- or speech-challenged individuals may access these numbers through TTY by calling the toll-free Federal Relay Service at 800-877-8339.)

If the dwelling does not use public water or receive water from a water supplier, but instead uses a private drinking water well, see the EPA's web site on Private Drinking Water Wells (<http://water.epa.gov/drink/info/well/>). In particular, that website has a page on "What You Can Do," which recommends testing at least annually, and information on how to identify potential sources of groundwater contamination. It has another page on "Frequent Questions," that identifies some reasons to test your water and what to test it for.

I. Lead Hazard Screen Protocol

As discussed in Section I.A.2, above, a lead hazard screen may be a cost-effective alternative to a full risk assessment for housing that is in good condition and was built after 1960. EPA work practices standards for a lead hazard screen are found at EPA 40 CFR 745.227(c).

A lead hazard screen consists of the following steps:

1. Questionnaire

Certain questions are necessary in a lead hazard screen in order to determine optimum dust sampling locations. For individual occupied units, use Form 5.0, or similar form, but questions 10-16 can be omitted. For multi-family properties, use Form 5.6, or similar form, but questions 4-6 can be omitted.

2. Building Condition

The building condition survey is important in order to document that the building is in good enough condition to justify a lead hazard screen. Use Form 5.1, or similar form. It is prudent to conduct the building condition survey before administering the questionnaire if the risk assessor is uncertain as to whether the building is in good enough condition for a screen.

3. Floor-Plan Sketch (Optional)

The risk assessor should decide whether a floor plan sketch is needed in order to unambiguously describe the location of surfaces with deteriorated paint and surfaces from which dust samples are collected. If the dwelling unit is relatively small, has few occurrences of deteriorated paint, and there is little likelihood that the descriptions on the visual assessment and dust sampling forms will be unclear, the sketch can be omitted. Otherwise, and usually, preparing the sketch will probably be worth the time. A site-plan sketch is usually not needed for a lead hazard screen, because soil sampling is usually not conducted.

4. Visual Assessment

In a lead hazard screen, the objective of the visual assessment is limited to identifying deteriorated paint, both interior and exterior, and paint chips on the ground. It is not necessary to identify friction surfaces, impact surfaces, or chewable surfaces, except that the risk assessor

should attempt to identify chewable surfaces if the owner or resident indicates in the questionnaire that a young child tends to mouth or chew painted surfaces. Use Form 5.2, or similar form.

5. Dust Testing

The risk assessor should conduct a basic dust sampling plan, as described in Section II.E. above. Dust testing for confirmation of friction-surface hazards is not necessary. Dust samples may be single-surface samples and/or composite samples. Before conducting a lead hazard screen, the risk assessor should confirm with the laboratory that its minimum reporting limit for lead in dust wipe samples will be adequate (that is, sufficiently low) to make a determination based on the stringent screening standards that apply. The laboratory may recommend that the sample areas (i.e., the areas wiped) be increased to assure a conclusive screen.

6. Paint Testing

Deteriorated paint surfaces must be tested for lead in accordance with the guidance in Section II.F, above. Testing of intact paint on friction surfaces is not necessary. Testing of paint on a chewable surface is required only if teeth marks are seen on the surface and there is a child under age 6 in the household.

7. Soil Testing

Soil sampling is necessary in a lead hazard screen only if there are paint chips on the ground.

8. Interpretation of Testing Results

For a lead hazard screen, dust testing results are interpreted against more stringent standards than those used in a regular risk assessment. (While the interior window sill standard for a lead hazard screen was reduced in half, from 250 $\mu\text{g}/\text{ft}^2$ to 125 $\mu\text{g}/\text{ft}^2$, the floor standard for a screen was reduced to 25 $\mu\text{g}/\text{ft}^2$ instead of 20 $\mu\text{g}/\text{ft}^2$ because some laboratory analytical methods and quality control measures may not provide sufficient reliability below 25 $\mu\text{g}/\text{ft}^2$.) Paint and soil testing results, however, are interpreted against the same standards as for a risk assessment. See Section V.D, below, for further guidance on interpreting testing results in a lead hazard screen.

9. Report

The report of the lead hazard screen must contain at least the following information:

- ◆ The date of the lead hazard screen.
- ◆ The address of each building included in the screen and apartment numbers (if applicable).
- ◆ Date of construction of the buildings.
- ◆ Name, address, and telephone number of each building owner and building manager.
- ◆ Name, signature, and certification number of the risk assessor conducting the screen.
- ◆ Name, address, and telephone number of the certified firm employing the risk assessor.

- ◆ Name, address, and telephone number of each laboratory conducting analyses of samples.
- ◆ The results of the visual assessment.
- ◆ Paint testing methods used.
- ◆ Specific locations of each painted component tested for lead.
- ◆ Results from onsite paint testing, including quality control data and, if used, the serial number of any XRF used.
- ◆ Results from laboratory analyses of paint and dust samples, and soil samples, if collected.
- ◆ Any background information from the administering of a questionnaire and/or the building condition survey.
- ◆ The risk assessor's interpretation of the paint, dust, and, if applicable, soil testing and his or her conclusion as to whether the property should or should not be subject to a full risk assessment.

The observations and environmental testing results of the lead hazard screen are usable in a follow-up full risk assessment, if necessary.

III. Risk Assessments for Evaluations of Different Size

The scope of the risk assessment will be determined in part by the number of dwellings that need to be evaluated. For single-family, owner-occupied dwellings, the basic information that the risk assessor needs to complete a comprehensive assessment is relatively easy to collect. A short interview with the owner will provide information about resident use patterns, past maintenance practices, and the resources that the owner can devote to hazard control. However, for an evaluation of a large number of rental dwellings, the assessor must gather information from the owner about the residents, the management company (if any), and the maintenance staff in order to confidently assess the viability of various hazard control options. Therefore, the protocols for collecting information from owners of multiple dwellings are more extensive than the protocols for owner-occupants.

At the same time, owners with a large number of dwellings to be evaluated may be able to reduce the per-unit costs of the risk assessment greatly. If, in the judgment of the risk assessor, the dwellings to be evaluated are sufficiently *similar*, the protocols allow the risk assessor to limit sampling to the dwellings that are most likely to present lead hazards to residents, as described below. The environmental sampling from these targeted similar dwellings is used to represent the lead-based paint hazards in all dwellings. For the purposes of risk assessment, the term *similar dwellings* describes those dwellings that:

- ◆ were built at the same time;
- ◆ have a common painting history;
- ◆ have a common maintenance and management history; and
- ◆ are of similar construction.

Similar dwellings do not need to be contained in a single housing development or in a single building to meet this definition; they also need not have the same number of rooms.

This section describes slightly different risk assessment protocols for the following situations:

- ◆ Assessment of an owner-occupied, single-family dwelling.
- ◆ Assessment of five or more similar rental dwellings.
- ◆ Assessment of fewer than five similar rental dwellings or multiple dwellings that are *not similar*.

Table 5.9 summarizes the key elements of a risk assessment for each category of assessment.

Table 5.9 Risk Assessment Approach for Evaluations of Different Size.

Action Required	Owner-Occupied, Single-Family Dwellings	Five or More Similar Rental Dwellings	Up to Four Rental Dwellings, or Rental Dwellings That Are Not Similar
Assess every dwelling	Yes	No	Yes
Deteriorated paint sampling (if no inspection conducted)	Yes	Yes	Yes
Dust sampling	Yes	Yes	Yes
Bare soil sampling	Yes	Yes	Yes
Water sampling	Optional	Optional	Optional
Air sampling	No	No	No
Management system analysis	Not applicable	Optional	Optional
Maintenance work systems modified	Cleaning and repair practices modified	Optional	Optional
Housing condition and characteristics assessment	Yes	Yes	Yes
Demographics and use patterns description	Yes	Yes	Yes

Like many recommendations in these *Guidelines*, these categories can be modified when necessary. The rationale for such modifications should be documented. For example, when evaluating a duplex or three-dwelling building where one dwelling is owner-occupied, the single-family protocols should be used with some minor modifications. In large multiple-unit dwellings that are not similar (see Section III, above), a risk assessor may be able to use dwelling selection procedures to contain costs. The selection process must be done with special care and with limitations fully described. To assist the risk assessor, standard risk assessment forms have been developed and are provided at the end of this chapter.

A. Risk Assessments for Owner-Occupied, Single-Family Dwellings

Evaluations in owner-occupied, single-family dwellings should include:

- ◆ An interview with the homeowner about resident use patterns, about the condition of the property, the age and location of children in residence, and the management and maintenance practices for the dwelling (optional).
- ◆ A visual assessment of the condition of the building and painted surfaces.
- ◆ Environmental sampling of deteriorated paint, dust, and soil.

The following forms should be used in the assessment of owner-occupied, single-family dwellings:

- ◆ **Form 5.0** – Questionnaire for a Lead Hazard Risk Assessment of an Individual Occupied Dwelling Unit.
- ◆ **Form 5.1** – Building Condition Form for Lead Hazard Risk Assessment.
- ◆ **Form 5.2** – Field Report of Visual Assessment for Lead Hazard Risk Assessment.
- ◆ **Form 5.3** – Field Paint-Chip Sampling Form.
- ◆ **Form 5.4a** – Field Sampling Form for Dust (Single-Surface Sampling) or
- ◆ **Form 5.4b** Field Sampling Form for Dust (Composite Sampling).
- ◆ **Form 5.5** – Field Sampling Form for Soil.

B. Risk Assessments for Five or More Similar Dwellings

Risk assessments for five or more similar dwellings should include:

- ◆ Information from the owner (or owner's representative) about the condition of the property, the age and location of children in the residence (if known), and the management and maintenance practices for the dwellings.
- ◆ The selection of dwellings and common areas for sampling.
- ◆ A visual assessment of the condition of the building and painted surfaces in the selected dwellings and common areas.
- ◆ Environmental sampling of dust, soil, and deteriorated paint in the selected dwellings and common areas.

The following forms should be used for evaluations of five or more similar dwellings:

- ◆ **Form 5.1** – Building Condition Form for Lead Hazard Risk Assessment.
- ◆ **Form 5.2** – Field Report of Visual Assessment for Lead Hazard Risk Assessment.
- ◆ **Form 5.3** – Field Paint-Chip Sampling Form.
- ◆ **Form 5.4a** – Field Sampling Form for Dust (Single-Surface Sampling), or **Form 5.4b** (Composite Sampling).
- ◆ **Form 5.5** – Field Sampling Form for Soil.
- ◆ **Form 5.6** – Questionnaire For a Lead Hazard Risk Assessment of More Than Four Rental Dwelling Units.

1. Targeted, Worst Case, and Random Sampling

The risk assessment protocol described here uses a targeted sampling strategy. Targeted sampling selects dwellings that are most likely to contain lead-based paint hazards to represent the other dwellings *based on information supplied by the owner* (i.e., units are not selected randomly or on the basis of visual evidence obtained by the risk assessor). The sampling protocol presumes that if the selected dwellings are free of lead hazards, it is highly probable that the other similar dwellings are also free of lead hazards. Targeted sampling has been used in public housing risk assessments for several years. This sampling protocol reduces the cost of assessment and is unlikely to miss significant lead hazards, provided accurate targeting information is provided by the owner.

Alternatively, similar dwellings can be evaluated with worst case sampling or random sampling. Worst case sampling requires a walk-through survey of *all* dwellings by the risk assessor in order to select the highest-risk dwellings based on direct visual evidence. Worst case sampling is not practical for most multiple dwellings, since it is nearly impossible to gain entry to all units in an expeditious fashion.

Some concerns have been raised about both targeted and worst case sampling, because it is not possible to quantify the degree of certainty associated with the findings as is the case for random sampling. However, if the risk assessor is conscientious about the proper selection of dwellings to be sampled (using the dwelling selection criteria), is confident that the information supplied by the owner is credible and complete, and is confident that the targeted dwellings meet the selection and similarity criteria, then the risk in a given development can be characterized sufficiently for the purpose of hazard control.

If the owner requires a statistically significant degree of confidence about the existence of lead-based paint hazards, random sampling should be used. Random sampling is recommended for lead-based paint inspections because the results are often used to develop more expensive, long-term hazard control measures or to provide a regulatory exemption if no lead-based paint is found. (Only a full lead-based paint inspection, not a risk assessment or limited paint testing, may be used to determine the absence of lead-based paint on a property.) A full discussion of random sampling and a random sampling protocol can be found in Chapter 7. Random sampling in multi-family settings with more than 20 pre-1960 units, or more than 10 1960-1977 units, usually requires more dwellings to be sampled and therefore may increase

the cost of the risk assessment compared with targeted or worst case sampling, with the trade-off that random sampling avoids questions about the quality of the criteria used for targeting or worst case sample selection. **However, the relatively small additional cost can provide for a more precise overall determination of the existence and location of lead-based paint hazards, which could significantly reduce the potential costs of conducting lead hazard control, and ongoing maintenance, activities.**

The risk assessor must be confident that targeted dwellings meet the dwelling selection criteria defined below. Targeted sampling should not be conducted if the owner is unable to provide accurate information about the occupancy status and physical condition of the dwellings to be sampled. If it appears that this information is unavailable or is being concealed by the owner, the risk assessor should resort to random or worst case sampling. Regardless of the sampling method, if any of the sampled dwellings contain identified lead hazards, all similar unsampled dwellings should also be presumed to contain similar hazards.

The risk assessor should provide, in the final report, a description of the unit sampling method used.

- a) **Number of Dwellings to be Sampled.** Table 5.10 describes the number of dwellings that are needed for targeted sampling. Targeted sampling cannot be used for evaluations of fewer than five similar dwellings, because, when fewer than five similar dwellings are being evaluated, *all* units should be sampled. The recommendations contained in Table 5.10 are drawn in part from a public housing risk assessment and insurance program. The empirical evidence suggests that the recommended number of units sampled adequately characterizes the risk in the entire housing development.

When determining the number of targeted dwellings, dwellings that are known to currently house children under age 6 with elevated blood lead levels should be excluded from the total unless there are more than 10 such units, in which case they should be added to the total. (See Chapter 16.)

Each dwelling housing a child under age 6 with an elevated blood lead level must be evaluated independently. Depending on state or local procedures, this evaluation may be performed by the state or local health authority or the risk assessor. If, after consultation with the health department, it is agreed that the risk assessor will perform an investigation, the evaluation should use the protocol that is described in Chapter 16 for dwellings housing children with elevated blood lead levels. This investigation should be completed *in addition* to the other units included in the risk assessment.

Since individual blood lead levels are confidential medical information, owners may not know whether children with elevated blood lead levels reside in their dwellings. Nevertheless, the risk assessor should request this information from the owner in order to try to better target the study.

- b) **Dwelling Selection Criteria.** The selection criteria found here offer general guidance for selecting targeted dwellings. Risk assessors should obtain the information needed from the owner's records (if available) or through interviewing the owner. Targeted dwellings should meet as many of the following criteria as possible (criteria are listed in order of importance).

- ◆ Dwellings cited with housing or building code violations within the past year.
- ◆ Dwellings that the owner believes are in poor condition.
- ◆ Dwellings that contain two or more children between the ages of 6 months and 6 years. (Preference should be given to dwellings housing the largest number of children.)
- ◆ Dwellings that serve as day-care facilities.
- ◆ Dwellings prepared for reoccupancy within the past 3 months.

If additional dwellings are required to meet the minimum sampling number specified in Table 5.9, the risk assessor should select them randomly.

If there are a number of dwellings that all meet the same criteria, then the dwellings with the largest number of children under the age of 6 should be selected. (Children tend to cause increased wear and tear on painted surfaces; therefore, dwellings where children reside are more likely to contain dust-lead hazards.) When possible, at least one dwelling in the sample should have been recently prepared for reoccupancy (although it need not be vacant), since the repainting and other repairs that are often conducted during vacancy can create a leaded-dust hazard. However, the risk assessor should not sample *only* dwellings that have recently been cleaned and repainted, since this would not accurately represent the conditions in the rest of the dwellings. If there are too many units that all meet the same criteria, the required number should be selected randomly. (See Chapter 7 for a discussion of random selection methods.) There can be many combinations of targeted dwellings that will all meet the selection criteria. The risk assessor should document which of the criteria were used to designate the dwelling as a targeted unit on the field sampling forms (Forms 5.3, 5.4a (or 5.4b), and 5.5). Figure 5.20, “Example of Targeted Dwelling Selection,” below shows how such a targeting system works.

C. Risk Assessments of Fewer Than Five Rental Dwellings and Multiple Dwellings That Are Not Similar

When evaluating fewer than five similar rental dwellings or multiple dwellings that are not similar, each of the dwellings should be assessed individually (see Section III.A above for the description of “similar dwellings,” and for forms and other information). The risk assessor will not be able to draw solid conclusions from a smaller sample. Evidence from the public housing risk assessment program suggests that hazards in different single-family, scattered-site dwelling units vary greatly, unlike similar multi-family dwelling units where a clear pattern of hazards typically exists among dwellings.

Table 5.10 Minimum Number of Targeted Dwellings to Be Sampled Among Similar Dwellings (random sampling may require additional units).

Number of Similar Dwellings	Number of Dwellings to Sample*
1-4	All
5-20	4 units or 50% (whichever is greater)**
21-75	10 units or 20% (whichever is greater)**
76-125	17
126-175	19
176-225	20
226-300	21
301-400	22
401-500	23
501+	24 + 1 dwelling for each additional increment of 100 dwellings or less

*Does not include dwellings housing children with elevated blood lead levels.

**For percentages, round up fractional dwellings to determine number of dwellings to be sampled.

1. Assessments of Five or More Dwellings That Are Not Similar

Owners of a large number of dwellings that are not similar may find the costs of a risk assessment evaluating all dwelling units daunting. These *Guidelines* therefore recommend that risk assessors use their professional judgment to determine whether there is a pattern of lead hazards among dwellings. If a clear pattern emerges, it may not be necessary to evaluate all dwellings.

The sampling method that should be employed is a modification of the targeted sampling model. Usually, it will be necessary to sample more dwellings due to increased variability.

- ◆ The risk assessor should collect information about the condition of the building(s) and the age and location of children in residence, and rank the dwellings based on the selection criteria.
- ◆ The risk assessor should then sample 25 percent of the total number of dwellings or five dwellings (whichever is greater).

- The first group of dwellings to be sampled should be chosen from the units thought to be at highest risk. The results should be evaluated to determine if a clear pattern of lead-based paint hazards can be discerned.
- If no clear pattern emerges, additional dwellings should be sampled until a pattern of hazard severity and location becomes apparent or until all dwellings have been sampled.

For example, a risk assessor evaluating 100 different dwellings selects a sample of 25 targeted dwellings. The risk assessor finds that 20 of the 25 targeted dwellings have high leaded-dust levels on interior window sills, but no other lead-based paint hazards are found. In this situation, the risk assessor may suggest to the owner that the interior window sills in most or all 100 dwellings are likely to be contaminated and therefore should be cleaned without further sampling. The owner must decide whether to follow this recommendation or continue the risk assessment for additional dwellings.

2. Assessments of Fewer Than Five Similar Dwellings

When conducting evaluations of less than five dwellings, risk assessors may find that it is appropriate to modify the amount of information they request from owners. Owners of a small number of dwellings are likely to have simplified management structures (e.g., the owner acts as both manager and maintenance worker). If this is the case, the risk assessor should shorten both the management and maintenance questionnaires.

For small evaluations, the risk assessor may find it helpful to interview residents using the resident questionnaire (after obtaining permission to do so from the owner). Risk assessors should notify residents that the questionnaire is optional and should not make more than one trip to the dwelling to collect the information. For large evaluations, the use of the questionnaire is not feasible.

D. Analysis of Management and Maintenance Practices (Optional)

Many forms of lead hazard control will require property management planning and careful maintenance work on surfaces that are known or presumed to contain lead-based paint. To help owners undertake these activities, risk assessors can collect information on how management and maintenance work is structured on a given property by using Form 5.6. Information on this form will help the risk assessor make practical recommendations on how maintenance work can be done safely for both workers and resident children. Analysis of management and maintenance practices is recommended but not required.

IV. Laboratory Analytical Procedures

Samples of paint, dust or soil must be analyzed for lead by a laboratory recognized by EPA under the National Lead Laboratory Accreditation Program (NLLAP) for analysis of lead in that medium. NLLAP monitors the analytical proficiency, management and quality control procedures of each laboratory participating in the program. NLLAP does not specify or recommend analytical methods. Information on this program can be obtained by calling the National Lead Information Center at 1-800-424-LEAD.

(Hearing- or speech-challenged individuals may access this number through TTY by calling the toll-free Federal Relay Service at 800-877-8339.) Useful information on the NLLAP program is available on the EPA web site at <http://www.epa.gov/lead/pubs/nllap.htm>. See Chapter 7 for further guidance.

EPA-recognized chemical test kits (“spot test kits”) which do not involve collecting a sample of the paint may be used by a certified renovator, certified lead-based paint inspector or certified risk assessor as described in Section II.F.2, above; these individuals need not be working for a laboratory recognized by NLLAP for analysis of lead in dust.

Field-portable XRF measurement of lead in paint does not involve collecting a sample of the paint, so it is not covered by NLLAP, and the measurements need not be performed by an NLLAP-recognized laboratory. See Chapter 7 for further guidance.

Field-portable XRF analysis has been used for measurement of lead in dust (Sterling, 2000; Harper, 2002) or soil (EPA, 2004; Binstock, 2009) with varying degrees of success; these methods do involve collecting a sample of the medium, so samples collected from target housing or pre-1978 child-occupied facilities, must be analyzed by a laboratory recognized by NLLAP for analysis of lead in the particular medium. The laboratory may be a mobile laboratory, field sampling and measurement organization, or a fixed-site laboratory, as discussed in Section II.E.6, above.

V. Evaluation of Findings

The ultimate goal of any risk assessment is to use the data gathered from the questionnaires and/or interviews, the visual assessment, and the environmental sampling to determine whether any lead-based paint hazards are present. (Hazardous levels of lead for risk assessment purposes are summarized in Table 5.11, below). If lead hazards are found, the risk assessor will also identify acceptable options for controlling the hazards in each property. These options should allow the property owner to make an informed decision about what actions should be taken to protect the health of current and future residents. The risk assessor’s recommendations could include hazard control measures to correct current lead-based paint hazards, and/or new property management and maintenance policies designed to prevent hazards from occurring or recurring.

A. Interpreting Results of Environmental Testing

Table 5.10 shows the criteria to be used for interpreting environmental samples collected during lead-based paint risk assessments.

1. Dust

EPA Hazard Standard

A dust-lead hazard is present in a residential dwelling, when the mass-per-area concentration of lead (also called “lead loading”) is equal to or greater than the levels in Table 5.11, below (see 40 CFR 745.65).

While most risk assessors use single-surface dust sampling, and comparing the results of each sampled area with the dust-lead hazard standards in order to obtain the most specific information about where lead in dust is located, several dust wipe samples from the same surface type (e.g., floor) may be combined to determine if a dust-lead hazard is present using the weighted

arithmetic mean of the samples (see 40 CFR 745.63). The purpose of weighting is to give influence to a sample relative to the surface area it represents. The weighted sample may include single-surface samples and/or composite samples. A composite sample may contain from two to four sub-samples, each of which should have been taken from an area that is the same size as the other, and the same size as any single-surface samples. Each single-surface sample included in the averaging with a composite should have the same area as each subsample (for example, 1 square foot on a floor). The weighted arithmetic mean is obtained in several steps; an example is shown to demonstrate how the process works:

The example (see the table below) is of a single-surface sample containing 60 µg/ft², a composite sample (with three subsamples) containing 100 µg/ft², and a composite sample (with four sub-samples) containing 110 µg/ft².

Step 1: For each sample being composited, calculate the product of the sample's lead loading multiplied by the number of subsamples in the sample. (For example, in the third sample shown in the table below, the product is 110 * 3 = 330.)

Step 2: Sum up the products (calculated in step 1) for all of the samples. (For example, 60 * 1 = 60, 100 * 3 = 300, and 110 * 4 = 440; and the sum of the products is 60 + 300 + 440 = 800.)

Step 3: Sum up the total number of subsamples in all samples. (For example, 1 + 3 + 4 = 8.)

Step 4: Divide the sum of the products (calculated in step 2) by the total number of subsamples in all samples (calculated in step 3). (For example, 800 / 8 = 100.)

The result in this example is that the weighted arithmetic mean is 100 µg/ft².

This result can also be obtained using the following formula, which is equivalent to the series of steps above:

$$[(60 * 1) + (100 * 3) + (110 * 4)] / (1+3+4) = [800] / (8) = 100.$$

Sample weight (µg/ft ²)	Number of subsamples
60	1
100	3
110	4

If both carpets and hard floors are sampled, the weighted average for floors should include both types of floor samples. That is, both carpet and hard-floor samples should be averaged together.

The EPA standards are based on "loading" (mass over area) instead of concentration (mass over mass). Loading is a better indicator of elevated blood lead levels and total amount of leaded-dust present inside the dwelling and is easily measured by the most widespread and inexpensive method of settled dust sampling, wipe sampling (Lanphear, 1996). The dust-wipe sampling protocols in Appendix 13.1 and in ASTM E 1728 are equivalent to the sampling method used in the research reported in Lanphear, 1996. In addition, cleaning can reduce loading but not necessarily concentration. Thus, loading is the most informative measure for risk assessment and post-lead hazard control clearance purposes currently available.

Some state and local jurisdictions use different standards for dust-lead hazards. If it is necessary for the dwelling to pass a local dust-lead hazard standard, the risk assessor should be familiar with the local standard and how that standard is measured. Where there are different legal or regulatory standards that may apply to a specific risk assessment or clearance examination, the most stringent (protective) applies.

Interpreting Detection Limits, Reporting Limits, “Non-detects” and “None Detected”

Methods used by laboratories to analyze the amount of lead in a wipe sample are limited in terms of how small an amount of lead can be measured and reported reliably. Therefore, laboratories accredited under the NLLAP program do not report values less than a “quantitation limit” or “reporting limit” that they have established for a given type of analysis, which is higher than the “method detection limit” (or, informally, “detection limit”).

- ◆ The “detection limit” or “method detection limit” is defined in 40 CFR, Part 136, Appendix B, which is cited by the NLLAP LQSR (see, especially pages 20, 24 and 50; <http://www.epa.gov/lead/pubs/lqsr3.pdf>) as the minimum concentration of a substance that can be measured and reported with 99% confidence that the analyte (substance) concentration is greater than zero. In other words, the presence of the analyte can be confirmed, but the precise concentration cannot be reliably determined.
- ◆ The “reporting limit” or “quantitation limit” is the lowest concentration that can be reliably measured (within specified limits of precision and accuracy) by the laboratory, it is generally 3 to 10 times the method detection limit. (NLLAP LQSR, especially pages 20, 24 and 41) Results that fall below the reporting limit will be reported as “less than” the value of the reporting limit, e.g., <11.0 µg/ft², BRL (below reporting limit), BQL (below quantitation limit), or ND (none detected), etc., dependent upon the laboratory’s reporting format. (NLLAP LQSR, especially pages 42 and 51)
- ◆ Results that are between the reporting limit and the maximum reporting limit will be reported as the determined value.

Lead professionals should contact their laboratory if they have specific questions on these matters.

Table 5.11 Federal Hazard Levels for Lead Hazard Risk Assessments.

Media	Lead Level (equal to or greater than)		
Paint*	1 mg/cm ² or 5,000 ppm (or µg/g)		
Dust (wipe sampling only; single-surface or composite; the weighted arithmetic mean of all samples of the same component type within a dwelling or common area is compared to the hazard level; for floors, carpet and hard-floor samples are averaged together):	Risk assessment	Lead hazard screen (dwellings in good condition only)	
	Carpeted floors	40 µg/ft ² (0.43 mg/m ²)	25 µg/ft ² (0.27 mg/m ²)
	Hard floors	40 µg/ft ² (0.43 mg/m ²)	25 µg/ft ² (0.27 mg/m ²)
	Interior window sills	250 µg/ft ² (2.70 mg/m ²)	125 µg/ft ² (1.40 mg/m ²)
Bare soil:*			
Bare soil in play areas	400 µg/g		
Bare soil in non-play areas in the dripline / foundation area and/or the rest of the yard (including gardens, pet sleeping areas, bare paths, and other spots)	1,200 µg/g		
Water (optional) — first draw, 250 mL	20 ppb (µg/L) **		

* See 40 CFR 745.65. Hazard levels may be lower in some state or local jurisdictions.

** 58 Federal Register 26548, June 7, 1991, at 26479. Not based on the risk assessment regulation at 40 CFR 745; see Section V.A.5, below.

Laboratory reporting limits typically vary from 10 to 20 µg for analysis of dust wipe samples for lead. Many, if not most, laboratories are in the 15-20 µg range. It is not uncommon for analyses of dust samples to yield values less than these reporting limits. How should a risk assessor calculate the weighted arithmetic mean lead loading if one or more of the samples are “non-detects?”

These *Guidelines* recommend that the risk assessor use the reporting limit minus 1 as the value to be included in the calculation of the weighted average for those samples that are reported by the laboratory to have an amount of lead that is less than the reporting limit. Thus, if the reporting limit is 15, presume for this purpose that the sample contained 15 minus 1, or 14 µg of lead. This procedure errs on the side of protectiveness, because it is quite likely that the actual level is less than the presumed level.

Interpreting Individual Samples That Exceed the EPA Standard

Because the EPA hazard standard is based on an average of all the wipe samples taken on the relevant surface (floor or interior window sill), the question arises as to what response is appropriate if one or more individual dust samples exceeds the hazard level but the average of all samples for a dwelling unit or common area does not. In this case there is no hazard according to the EPA standard, yet the risk assessor is confronted with one or more surfaces with high dust-lead levels. These *Guidelines* recommend that, in these cases, the risk assessor recommend cleaning of the surfaces or spaces with the high levels, and untested surfaces of the same component type. Possible examples of this situation might include a high lead level on the entryway floor, or a high level on a hard surface floor in a dwelling unit with mostly carpeted floors (that typically have lower lead levels in wipe samples than hard floors), or a high level on a specific window sill with a friction-surface hazard.

Figure 5.20 Example of Targeted Dwelling Selection.

A risk assessor is hired to conduct a risk assessment for 30 dwellings owned by a single property owner. Twenty-five of these dwellings are apartments in the same building, have similar construction and painting histories, and were acquired simultaneously. The other five were acquired from different owners at different times, have had little previous rehabilitation work, and have different construction styles. One of the 25 similar dwellings is known to house a child with an elevated blood lead level. The local health department has already informed the risk assessor that the department has no plans to evaluate the dwelling due to a staffing shortage.

In this case, the risk assessor will evaluate the following:

- ◆ Five dwellings of different construction.
- ◆ One dwelling housing the child with the elevated blood lead level (see Chapter 16).
- ◆ Ten dwellings of similar construction (in Table 5.4, 24 total dwellings require 10 dwellings to be sampled).

The risk assessor will conduct sampling in 16 dwellings, with the 10 targeted dwellings used to represent the 24 similar dwellings that do not house children with elevated blood lead levels. For the 24 similar dwellings, the owner has provided the following information about residents:

- ◆ Six dwellings have three children under age 6.
- ◆ Three dwellings have two children under age 6.
- ◆ Five dwellings have one child under age 6.

- ◆ Nine dwellings have an unknown number of children.
- ◆ One dwelling is vacant and has recently been prepared for reoccupancy. In addition, the owner has supplied the following resident use and maintenance information:
- ◆ Two dwellings have building code violations (one with three children, one with one child).
- ◆ Three dwellings have a history of chronic maintenance problems and are in relatively poor condition (two with an unknown number of children, one with two children).
- ◆ There are no known day-care facilities.

Based on this information, the risk assessor targets the following dwellings:

- ◆ Two dwellings with building code violations (one with three young children).
- ◆ Three dwellings rated in poor condition.
- ◆ One dwelling recently prepared for reoccupancy.

This yields six dwellings. The final four dwellings should be selected from among the five remaining similar dwellings that house three young children. Since there are no distinguishing factors among the five dwellings, the final four dwellings are selected randomly from this group.

Risk assessments of fewer than five similar dwellings or multiple dwellings that are not similar should include:

- ◆ The collection of information from the resident and/or the owner (or owner's representative) about the condition of the property, the age and location of children in residence, and the management and maintenance practices for the dwelling (optional).
- ◆ A visual assessment of the condition of the building(s) and painted surfaces of all dwellings.
- ◆ Environmental sampling of dust, soil and deteriorated paint in all dwellings (and common areas of multi-family developments).
- ◆ Use the forms for single family evaluations

For all hazard evaluations, the data should be examined to determine if consistent patterns emerge (e.g., the interior window sills contain high levels, while floors are low); such patterns will aid in the development of recommendations for focused, cost-effective control measures.

2. Paint

If paint contains lead equal to or greater than either of the following levels, it is considered to be lead-based paint under the Lead-Based Paint Poisoning Prevention Act (see Appendix 6):

- ◆ 5,000 µg/g (also expressed as 0.5 percent by weight, 5,000 mg/kg, or 5,000 ppm by weight). (paint chip samples analyzed in the laboratory by atomic absorption spectroscopy or inductively coupled plasma emission spectroscopy will usually be reported by weight percent.)
- ◆ 1.0 mg/cm² (XRF machines report lead content by area).

These are not equivalent standards. They are alternative standards, which are necessary because of the fundamentally different methods of measurement: the first is a concentration (mass over mass), and the second, “loading” (mass over area).

Some state and local jurisdictions may have lower (i.e., more stringent) standards.

It should be understood paint that has lead below the federal (or other) standard can still pose a health hazard, such as if a large enough area of such paint is subject to high-speed abrasion without dust capture.

Any component that contains deteriorated lead-based paint is a lead-based paint hazard and should be treated. If the amount of lead in deteriorated paint in federally-owned or -assisted housing is below the regulatory limit, lead hazard control measures are not required by Federal regulation (although paint stabilization is still recommended). Any component with deteriorated paint that is not tested and does not have a painting history similar to a tested component should be considered a lead-based paint hazard. (See Chapter 7 for guidance on sampling of components.) In the event that all paint tests are below the standard, the owner cannot presume that *all* surfaces in the dwelling are free of lead-based paint, since not all surfaces were tested. Instead, the owner must have a complete lead-based paint inspection (not a risk assessment) performed to document the absence of lead-based paint on a property. The owner should presume that untested paint surfaces in pre-1978 structures contain lead-based paint.

3. Bare Soil

Play Area Hazard Determination

A play area with bare soil containing lead levels equal to or exceeding 400 ppm is considered a soil-lead hazard. If all play areas with bare soil were sampled, the risk assessor should recommend lead hazard controls for each play area that is a soil-lead hazard, based on laboratory results. If, however, certain play areas were selected for soil sampling, and one or more of those play areas is determined to be a soil-lead hazard, the risk assessor should recommend *either* that all *unsampled* play areas with bare soil be treated as soil-lead hazards *or* that soil samples be collected from the unsampled play areas and that those with lead levels in excess of the standard be treated as hazards.

Non-play Area Hazard Determination

Bare soil in a non-play area, whether in a dripline/foundation area or in the rest of the yard, is considered a soil-lead hazard if it is represented by a composite soil sample with a lead level equal to or exceeding 1200 ppm.

The EPA's soil-lead hazard standard does not include a *de minimis* bare soil area threshold. "EPA's reasoning is that the disadvantages of establishing a *de minimis* outweighed the advantages. EPA has no analysis or data that relate the amount of bare soil to risk. EPA also believes that a *de minimis* area of bare soil provides little benefit." (EPA. Lead; Identification of Dangerous Levels of Lead; Final Rule. 66 *Federal Register* 1206, January 5, 2001, at 1226-1227. <http://www.epa.gov/fedrgstr/EPA-TOX/2001/January/Day-05/t84.pdf>.) EPA went on to say (at 1227) that, "However, EPA highly recommends using the HUD Guidelines for risk assessment (Ref. 5). This would avoid declaring very small amounts of soil to be a hazard in the non-play areas of the yard. This would also help target resources by eliminating the need to evaluate soil or respond to contamination or hazards for properties where there is only a small amount of bare soil."

This edition of these *Guidelines* recommends, similarly to its recommendation in the 1995 edition cited by EPA, that, if the total surface area of bare spots in non-play areas on a property is no more than 9 square feet (0.83 square meters), the risk assessor may declare that soil samples are not necessary and avoid declaring that a lead-based paint hazard exists in those non-play areas.

If two or more composite samples were collected to represent bare soil in a certain area, the risk assessor should calculate an arithmetic mean of the results of the sample analyses in order to determine whether the subject area is a soil-lead hazard.

These general principles are illustrated in Figure 5.21.

◆ **Example:** In this example, the property has nine residential buildings, five of which were selected for sampling in accordance with principles described in Section II.G.3, above. A composite sample of bare soil was collected from the dripline/foundation area and from the rest of the yard associated with each of the five selected buildings, except that no sample was collected from the dripline/foundation area of buildings #1 and #4 and no sample was collected from the rest of the yard in buildings #3 and #8, because there was no bare soil. The following data are obtained from Form 5.5, or similar form, for non-play areas:

There are no soil-lead hazards in non-play areas of the rest of the yard in the sampled buildings. Therefore the risk assessor may find that there are no hazards in the rest of the yards associated with the unsampled buildings.

For the sampled buildings, soil-lead hazards are present in the dripline/foundation areas of buildings #6 and #8. In order to determine whether there are hazards in the dripline/foundation areas of unsampled buildings, the risk assessor should calculate an arithmetic average of the results of the dripline/foundation area samples that were collected.

Figure 5.21 Example of Soil Hazard Determination in Non-Play Areas.

Residential Building No.	Type of Non-play Area Sampled	Laboratory Result (ppm)
#1	Rest of the yard	300
#3	Dripline/foundation area	800
#4	Rest of the yard	350
#6	Dripline/foundation area	2,000
#6	Rest of the yard	750
#8	Dripline/foundation area	2,400

For the non-play areas of the rest of the yard in the sampled buildings, because all of the lead concentrations are below the soil-lead hazard level of 1200 ppm, there are no soil-lead hazards in these rest-of-the-yard areas. Therefore the risk assessor may find that there are no hazards in the rest-of-the-yard areas associated with the unsampled buildings.

For the dripline/foundation areas of sampled buildings #3, #6 and #8, some of the lead concentrations are at or above the soil-lead hazard level of 1200 ppm, and some are below. In order to determine whether there are hazards in the dripline/foundation areas of unsampled buildings, the risk assessor should calculate an arithmetic average of the results of the dripline/foundation area samples that were collected.

The average of the three results is calculated as follows:

$$800 + 2,000 + 2,400 = 5,200$$

$$5,200 / 3 = 1,733$$

Because 1733 is greater than the standard of 1200, the risk assessor must determine that any bare soil in dripline/foundation areas associated with the unsampled buildings is a soil-lead hazard. This determination would be changed if such unsampled soil is sampled and the laboratory results indicate the absence of a hazard.

There is no federal hazard standard or guideline for lead in garden soil. Research on plant uptake of lead suggests that a lead concentration 400 ppm is reasonably protective as a maximum value for vegetable garden soil (Finster, 2004). This recommendation is also based on the need to protect young children when accompanying adults in garden areas.

Note, finally, that some state, tribal, and local jurisdictions may have soil-lead standards that are more protective than those discussed above.

4. Hazard Evaluation by Targeted, Worst-Case, or Random Sampling

- a) **Dust:** When a multi-family property is evaluated with targeted, worst-case, or random sampling of dwelling units (see unit III.B.1, above), the risk assessor must conclude that a dust-lead hazard is present on floors or interior window sills of an unsampled dwelling unit or common area if a dust-lead hazard is found (using procedures and standards described in the preceding paragraphs) on floors or interior windows sills, respectively, in one or more of dwelling units or common areas on the property.

When any of the sampled dwelling units or common areas have dust-lead hazards, the risk assessor and the property owner or manager must decide whether it is more cost-effective to clean and control hazards in all the unsampled units (or common areas) or to conduct dust sampling in a random sampling or all of the unsampled units or areas and clean and control only those units found to contain hazards. The owner, with the assistance of the risk assessor, should estimate the costs and benefits of more sampling versus cleaning all units. It would not pay to continue sampling if almost all of the sampled units and common areas have dust-lead hazards. It would pay to sample more if only a small percentage have hazards, except when renovation or paint-lead hazard control work will be conducted in most of the unsampled units, in which case cleanup will be required after the work anyway. If random sampling is to be conducted of previously unsampled units or common areas, it is recommended that the random sampling procedures and interpretive decision logic of Chapter 7 be followed.

- ◆ For properties constructed between 1960 and 1977, and for properties constructed before 1960 which have fewer than 178 units, the entire number of units in the properties is used for determining the number of units to be randomly sampled in accordance with Chapter 7's table 7.3. The units sampled through targeted or worst-case selection of those properties are not considered in the random selection process; all units in the property are used for the random selection process. (If it happens that some of the already-sampled units are selected for random sampling, the results for those already-sampled units may be used without having to be retested.)
 - ◆ For properties constructed before 1960 which have 178 or more units, the entire number of units in the properties is used for determining the number of units to be randomly sampled in accordance with Chapter 7's table 7.3, but the units sampled through targeted or worst-case selection are excluded from the random selection process because those already-sampled units are counted for the random selection process, and their sampling results used as part of the random sample results. The number of units already sampled is subtracted from the number of units to be sampled randomly per table 7.3; the remaining unsampled units are the ones from which units are randomly selected. (For example, during targeted sampling, in a property of 200 pre-1960 units, 20 units were sampled. Once the owner chooses to switch to random sampling, table 7.3 indicates that 51 units are to be sampled randomly. Only $51 - 20 = 31$ units need to be randomly sampled; these units are selected from among the $200 - 20 = 180$ unsampled units.)
- b) **Paint.** Targeted sampling presumes that all dwellings under assessment have similar (but not identical) painting histories. Therefore, if the bathroom door in one dwelling is coated with lead-based paint, then it is highly likely that bathroom doors in all similar dwellings are also coated with lead-based paint. To determine that lead-based paint is *not* present

throughout a development, see Chapter 7. The results of the paint testing should be analyzed by component type and room-equivalent type. If all components of a certain type in a type of room equivalent are at or above the paint standard or all are below, then the risk assessor can presume that this condition is true for the total population of similar dwellings. However, if a component/room-equivalent combination (e.g., living room baseboards) contains lead-based paint in some dwellings and not in others, the owner must presume that all similar components present a lead hazard unless paint testing or a lead-based paint inspection shows otherwise.

5. Water (Optional)

Water sampling, which is optional for a routine risk assessment, can be interpreted using the current EPA action level for lead in drinking water at individual outlets (not the entire distribution system) in schools (because EPA does not have an action level for individual outlets in homes), which is:

- ◆ 20 ppb (20 parts per billion; 20 micrograms per liter; 20 µg/L; or 0.020 mg/L) – drawn as a 250 mL first draw after the water has remained in the pipe overnight (with the water standing for at least 6 hours).

(EPA noted that the distribution system-wide lead action level of 15 ppb in water at the 90th percentile of the sampled outlets, and the individual-outlet “lead action level[] differ because of the different problems they seek to detect and the different monitoring protocols used in the two situations.” 58 *Federal Register* 26548, June 7, 1991, at 26479. <http://water.epa.gov/drink/info/lead/excerptfrom58.cfm>).

If any of the first-draw tap water samples exceed 20 ppb lead, the risk assessor should recommend that the client (typically the owner) take the water outlets from which those samples were drawn out of service, and that the owner contact the local water department to determine if corrosion control or other control measures are in the process of being implemented. (<http://water.epa.gov/drink/info/lead/testing.cfm>) If the dwelling does not use public water or receive water from a water supplier, but instead uses a private drinking water well, see Section II.H, above, and the references in that section.

See appendix 13.5, “EPA Information on Drinking Water,” for the EPA pamphlet, “Is there lead in my drinking water?” This pamphlet, intended for the general public, is also available in the graphic format in the appendix at http://www.epa.gov/safewater/lead/pdfs/fs_leadindrinkingwater_2005.pdf, as well as in a text format as a factsheet at <http://water.epa.gov/drink/info/lead/leadfactsheet.cfm>.

The risk assessor should inform the owner and/or resident that often the simplest way to reduce lead in drinking water is to flush the water lines by letting the cold water kitchen tap run for a minute or two whenever the water has not been used for 6 hours. This helps only if the lead is from the home’s plumbing, not the service lines.

Further information on water sampling and interpretation of results is at EPA’s “Lead in Drinking Water” website, at <http://water.epa.gov/drink/info/lead/>, and the EPA’s Safe Drinking Water Hotline at 800-426-4791. (Hearing- or speech-challenged individuals may access this number through TTY by calling the toll-free Federal Relay Service at 800-877-8339.)

6. Other Lead Sources (Optional)

If other lead sources are discovered in the dwelling, the risk assessor should inform the client (typically the owner), and recommend the client contact the local health department or the local childhood lead poisoning prevention program for assistance in devising control strategies and assessing the degree of risk. However, it should be understood that a typical risk assessment, as distinguished from an environmental investigation in response to a child with an elevated blood lead level (see Chapter 16), does not seek to identify all possible sources of lead that may be present on a property. Rather, a typical risk assessment is designed to identify only “lead-based paint hazards” as defined in Section I, above.

For information on other sources, consult the Federal lead information pamphlet, *Protect Your Family from Lead in Your Home* (<http://www.epa.gov/lead/pubs/leadpdf.pdf>).

If it appears that a parent or other resident works in a setting that exposes them to lead, and is bringing lead hazards into the house, the Occupational Safety and Health Administration (OSHA) can be notified anonymously by the resident. http://www.osha.gov/html/Feed_Back.html is OSHA’s The Contact Us webpage; it shows:

- ◆ The toll free number to report unsafe working conditions or safety and health violations, or ask workplace safety and health related questions, 1-800-321-OSHA (6742) (hearing- or speech-challenged individuals may access this number through TTY by calling 1-877-889-5627);
- ◆ The procedure for filing a complaint form with OSHA;
- ◆ Information on submitting workplace safety and health related questions by e-mail, mail, or on-line form;
- ◆ A map of OSHA offices, with links to the addresses and phone and fax numbers for the OSHA Regional Offices, Area Offices, and On-site Consultation Program Offices; and
- ◆ Instructions on how to view, download and order publications, forms, or the OSHA poster.

The OSHA lead standards (29 CFR 1910.1025 and 1926.62) contain important provisions to prevent workers from “taking home” occupational dust containing lead. (See Chapter 9 and Appendix 6.)

B. Evaluating Management Policies (Optional)

Except in the case of complete removal of all lead-based paint (or all components coated with lead-based paint), some type of ongoing management and maintenance of lead hazards will be required for all properties. Homeowners and owners of only a few dwellings will generally have to take on this responsibility themselves. When a risk assessor begins to describe hazard control options to these owners, it is important that the ongoing management and maintenance, monitoring, and reevaluation requirements are explained fully for each option. Chapter 6 provides guidance on lead-safe maintenance.

For owners of larger multiple dwellings, adequate management staff may already be in place, but this new responsibility may not be understood. The owner should assign responsibility for managing the various aspects of a lead hazard control program, and the program should be described in

a Lead Hazard Control Policy Statement (see Figure 5.22). The Statement documents the owner's awareness of the lead hazard problem and intention to control it. In addition, the Statement authorizes a specific individual to carry out the lead hazard control plan; assigning clear responsibility to a single individual is especially important for multiple owners and property management companies. The owner (with input from the risk assessor) should determine which employees are best positioned to conduct the following activities:

- ◆ Training and management of staff who will maintain hazard controls.
- ◆ Periodic surveillance of lead hazards and hazard controls.
- ◆ Response to resident reports of deteriorated paint.
- ◆ Response to reports of resident children with elevated blood lead levels.
- ◆ Controlled maintenance and repair work.
- ◆ Other lead-related activities or problems.

The risk assessor should recommend that the responsible individual acquire training. Often, the best person for this role is someone in authority who has received previous training and who has demonstrated concern about the issue. HUD recommends that lead managers take an appropriate lead management course. If none is available, a HUD-approved curriculum in Lead Safe Work Practices, such as the EPA/HUD Renovation, Repair and Painting (RRP) course (see Appendix 6) should suffice. Information about the curricula listed is available on HUD's website at: www.hud.gov/offices/lead/training. These curricula are approved by EPA and HUD as meeting the training requirement of EPA's RRP Rule for individuals performing or supervising maintenance or interim controls activities that disturb significant amounts of paint in target housing and pre-1978 child occupied facilities. (If all of the work that would trigger the RRP Rule will be performed by outside contractor(s), so that the lead hazard control program manager is not directly performing the work or supervising the workers, the manager is not required to take the training, although HUD recommends doing so in order to enhance the manager's understanding of the activities of the contractor(s).)

The dwelling turnover process should be reviewed to determine if work practices and cleaning efforts require modification. The risk assessor should decide what types of wet cleaning and repainting efforts can be achieved safely by the owner. Environmental data gathered from dwellings recently prepared for reoccupancy should be examined to determine if hazard control measures are taking place while the dwelling is vacant (when such measures are often much easier and cheaper to complete).

Figure 5.22 Example of a Lead Hazard Control Policy Statement.

_____ (property owner/management firm name) is committed to controlling lead-based paint hazards in all its dwellings.

_____ (name), _____ (position or job title), has my authority to direct all activities associated with lead hazard control, including directing training, issuing special work orders, informing residents, responding to cases of children with elevated blood lead levels, correcting lead-based paint hazards on an emergency repair basis, and any other efforts that may be appropriate. The company's plan to control such hazards is detailed in a risk assessment report and lead hazard control plan.

(Signed) _____ (Date)
(Property Owner/Property Manager)

(Signed) _____ (Date)
(Lead Hazard Control Program Manager)

As part of the management evaluation process, the risk assessor should examine the owner's occupational safety and health program. See Chapter 9. Training is essential for maintenance personnel to ensure that they are protected and that they do not inadvertently create lead hazards in the course of their duties. Training is required for maintenance personnel in federally assisted, pre-1978 properties. For maintenance work that is covered by EPA's RRP Rule, at least the certified renovator who is supervising the work, must be trained and certified; the RRP Rule requires at least on-the-job training for the other workers, and permits the other workers also to be certified as renovators. For maintenance work that is covered by HUD's Lead Safe Housing Rule (typically in addition to being covered by EPA's RRP Rule), the supervisor and the other workers must be trained and certified as renovators. (See Chapter 11 and Appendix 6.) If qualified to address these occupational safety and health issues, the risk assessor may determine if respirator usage (and a respirator program), a medical surveillance program, or specialized equipment (notably a HEPA vacuum) are needed.

The risk assessor should help the owner decide what immediate actions to take if a child with an elevated blood lead level is identified. For example, the owner should consider what options are available to house the family temporarily (e.g., in one of the owner's lead-safe dwellings) if it appears the original dwelling may contain the source of lead. At a minimum, the owner should know where alternate housing can be found on a rapid response basis. Some property owners perform periodic general housing quality inspections, either on turnover or on a set schedule. The risk assessor should assist the owner in developing a plan for evaluating the condition of presumed or known sources of lead-based paint during these routine inspections.

The risk assessor can also help a larger property owner decide which properties should be assessed first, through developing a risk assessment/hazard control plan.

C. Maintenance of Multiple Dwellings (Optional)

In the course of the risk assessment, the risk assessor should determine if current maintenance practices are adequate to control lead hazards. Specifically, repainting should be performed at least every 5 years (more frequently when paint appears to be in poor condition). When repainting, the owner should be encouraged to use a lead-specific cleaner or deglossing agent to prepare the surface, and/or change to wet scraping and sanding, followed by the appropriate cleaning procedures described in Chapters 11 and 14. Specialized cleaning should always be performed following maintenance or repainting when disturbed surfaces are known or presumed to contain lead-based paint. Chapter 6 provides guidance on lead-safe maintenance.

If the property owner uses standard work order forms, the risk assessor should determine whether they contain proper instructions about working on known or presumed lead-based painted surfaces. For example, the work orders should instruct workers when to use respirators, implement dust containment, work wet, and use special cleaning measures (see Chapter 6).

The quality of the maintenance operation should also be evaluated from the prevalence of building or housing code violations, the condition of paint, and the condition of the building as rated on Form 5.1. If the building is in "poor condition," if there have been more than two code violations over the past 2 years, or if the condition of the paint is especially poor, then the risk assessor should evaluate the relationship between these findings and the implementation of the maintenance operation to see if it is deficient and if lead-based paint hazards are not being adequately managed. Such a situation may require a more frequent monitoring schedule (until removal of all lead-based paint is completed). See Chapter 6 for further details.

D. Lead Hazard Screen in Dwellings in Good Condition

Different criteria are employed to evaluate the results of lead hazard screens, which are limited to dwellings that are in good condition. Since less data and fewer samples are collected, more stringent standards are applied to determine if a full risk assessment is needed. This minimizes the possibility of failing to detect a lead-based paint hazard.

If the results of the dust or paint samples are equal to or greater than the levels shown in Table 5.11 (in Section V.A.1, above) for a lead hazard screen, a full risk assessment should be performed to determine if and where hazards truly exist in the housing. Environmental sampling results obtained from the lead hazard screen can be used in the full risk assessment. The screen criteria were developed by reducing the hazard standards for floors and for interior window sills. Reducing the standards, increases the ability of the screen to detect potential lead hazards is increased.

The criteria for the presence of lead-based paint in deteriorated paint, whether by XRF measurements or paint chip sample results, are the same as for a full risk assessment. If more than the *de minimis* amount of deteriorated paint (see Section II.D.3, above) is found to be lead-based paint, that deteriorated paint is a lead-based paint hazard, so a full risk assessment should be completed.

VI. Risk Assessment Report

The report compiled by the risk assessor documents the findings of the risk assessment and identified control methods. Report writing is an important element of completing risk assessments. The

professional responsibilities of a risk assessor include writing reports that are well-written, understandable, and meet EPA requirements. Clients, such as owners, are encouraged to request report revisions for clarity and regulatory compliance. This section describes the format of such a report, as well as general guidance on how to provide control options. The hazard control chapters of these *Guidelines* provide further information on the various forms of lead hazard control.

A. Site-Specific Hazard Control Options

First, the report should state whether any lead hazards were found at the dwelling. After the nature, severity, and location of identified lead hazards are described, the report should inform the owner of the range of acceptable hazard control measures.

1. Control Measures

These control measures range from various interim controls (e.g., specialized cleaning, minor wet scraping, and repainting) to abatement measures (e.g., building component replacement, enclosure, and paint removal) that may not, for such reasons as funding limitations, be conducted for a while. Table 5.12 lists the major options and scenarios, although the number of possibilities and combinations is virtually unlimited, and the absence of an “x” in a cell of the table does not mean that the recommendation may not be made. For example, if the risk assessor finds that interior window sills are highly contaminated with leaded-dust and deteriorated lead-based paint, but the owner has very limited resources, dust removal and paint film stabilization would be the most appropriate course of action. However, if more resources are available, perhaps the entire window should be replaced. For some properties, federal, state or local regulations may require a specific type of hazard control action.

Special attention should be given to hazard control recommendations pertaining to friction, impact and chewable surfaces as well as to deteriorated paint. If there is a *friction-surface* hazard (i.e., there is lead-based paint on a friction surface and the dust underneath the surface (or on it, in the case of a floor or stair tread) is a dust-lead hazard), the painted surface should be treated in such a way that paint that is known or presumed to be lead-based paint does not continue to be subject to friction or abrasion. Paint stabilization is not sufficient. Interim control of friction-surface hazards on windows is often difficult. Channel liners sometimes interfere with the smooth operation of the window and may not stay in place. While friction-surface hazards on doors can often be eliminated by properly re-hanging the door, this is rarely the case with double-hung windows, where there is usually some rubbing between the sash and the channel, even with a smoothly operating window.

It is important to note that paint stabilization may be an acceptable option if there is deteriorated lead-based paint on a friction surface but the risk assessor has *not* determined that there is a dust-lead hazard under or, for floors or stair treads, on the surface. In this case, a friction-surface hazard has not been established.

Friction-surface hazards on floors, stairs, counters, shelves and similar surfaces should be covered with a durable material appropriate to the surface, or the paint should be removed or the component should be replaced.

Paint hazards on impact surfaces can often be eliminated by paint stabilization and correcting the mechanical problem causing the impact, such as installing a door stop or, again, re-hanging the door.

If there is a chewed surface with lead-based paint and a child under 6 is present, the surface should be covered with a material that cannot be penetrated by the bite of a young child, the paint should be removed or the component replaced.

2. Education

The risk assessor who has an ongoing relationship with the property owner or property manager / agent has a special role to play in educating the various parties involved in lead-poisoning prevention. Title X specifically states that lead hazard control efforts should include education, since it is critical to the success of any interim control or abatement plan. In a multi-family development, this includes education for management and maintenance staff and residents. While the risk assessor cannot be expected to train and educate everyone, some simple steps can and should be recommended in the final report.

- a) **Management Staff Education.** While meeting with the owner or property manager to describe the lead hazard control options available, the risk assessor can help educate them on the seriousness of lead hazards and the feasibility of avoiding or controlling them. The EPA lead hazard information pamphlet, pre-renovation education pamphlet, or other local literature should be handed out. Information on the EPA Pre-Renovation Education Rule and the EPA Renovation, Repair, and Painting (RRP) Rule should also be provided (see Appendix 6). The EPA brochures are available from the National Lead Information Center (800-424-LEAD; www.epa.gov/oppt/lead/pubs/nlic.htm) and the EPA website, <http://www.epa.gov/lead/pubs/brochure.htm>. (Hearing- or speech-challenged individuals may access this number through TTY by calling the toll-free Federal Relay Service at 800-877-8339.)
- b) **Maintenance Staff.** The risk assessor should inform the owner of the EPA RRP Rule and OSHA Lead Standard requirements as they apply to maintenance workers who may be involved in repair work on surfaces coated with lead-based paint and the employer's obligation to train those workers (see Chapter 9 and Appendix 6).
- c) **Residents.** The risk assessor should recommend to the owner that all information regarding the presence of lead-based paint hazards be shared with tenants. Under the Lead Safe Housing Rule, if the target housing property receives housing assistance from HUD or is owned by HUD, the owner must provide the results of the risk assessment to residents (24 CFR 35.125). Also, under the Lead-Based Paint Disclosure Rule issued by both HUD and EPA, landlords must disclose knowledge, records and reports of lead-based paint hazards (and lead-based paint) to prospective tenants, and disclosure must also be made to existing tenants at time of lease renewal if there is new information (24 CFR Part 35, Subpart A, and 40 CFR Part 745, Subpart F).

Table 5.12 Main Hazard Control Options That Could Be Identified in Risk Assessments Based on Actual Conditions.

Treatment Option	Dust ¹ on Floor	Dust ¹ on Window Sills	Paint ² on Doors	Paint ² on Windows	Paint ² on Floor and Wall	Paint ² on Trim	High Soil Lead Levels
Dust Removal	x	x	x	x	x	x	x
Paint Film Stabilization	x	x	x	x	x		
Friction Reduction Treatments	x		x		x		x
Impact Reduction Treatments	x	x			x		x
Planting Grass						x	x
Planting Sod						x	x
Paving the soil						x	x
Encapsulation				x	x		
Enclosure				x	x		
Paint Removal by Heat Gun ³		x	x	x	x		
Paint Removal by Chemical ³		x	x	x	x		
Paint Removal by Contained Abrasive ³		x	x	x	x		
Soil Removal	x ⁴					x	x
Building Component Replacement		x	x	x	x		

¹ Dust-lead hazard.

² Deteriorated lead-based paint.

³ Limited areas only.

⁴ If soil-lead hazard present.

B. Cost and Feasibility

1. Cost

Each owner will have a different level of available funding. Some will be able to make a long-term investment that will require a large capital outlay but will be less expensive in the long run, adding to the value of the property. Others will be unable to make this type of investment and will opt for short-term measures that require smaller initial outlays and more frequent monitoring. The risk assessor should endeavor to provide information that will assist the owner in making an informed decision on this complex issue. The owner, not the risk assessor, must make the final decision. Costs for various treatments vary considerably from one locale to the next and are subject to market conditions, making it difficult to provide cost estimates. However, the risk assessor should at least indicate the order in which acceptable hazard control options for a given hazard fall in terms of relative initial cost. That is, the options should be described in terms such as “lower initial cost” and “higher initial cost.”

2. Feasibility

In addition to cost, the risk assessor should identify treatments that are unlikely to be effective, such as:

- ◆ Repainting or encapsulating an area of deteriorated paint caused by moisture problems (leaky roof, poor vapor barrier, uncorrected plumbing problem, window air conditioner, etc.) without correcting the moisture problem first.
- ◆ Repainting or encapsulating an area subject to impact and friction.
- ◆ Repainting or encapsulating deteriorated paint or varnish without preparing the surface first.
- ◆ Attaching encapsulants or enclosures to deteriorating structural members that may not be able to support the integrity of the enclosure or the additional weight of the encapsulant.
- ◆ Applying liquid encapsulants to deteriorated substrates.
- ◆ Replacing window sashes in frames that are severely deteriorated.
- ◆ Cleaning surfaces that are not sealed or made “cleanable.”
- ◆ Cleaning highly soiled furnishings and carpets, instead of replacing them.
- ◆ Mulching or covering lead-contaminated soil in areas where pets tend to sleep or dig.
- ◆ Planting grass seed in high-traffic areas.
- ◆ Treatments in properties which are frequently damaged.
- ◆ Of course, the risk assessor must also emphasize the danger of using prohibited methods of lead hazard control, such as uncontained abrasive, sand, or water blasting; power-sanding; or open-flame burning of painted surfaces.

C. Reevaluation Recommendation

If the property is HUD-assisted, the risk assessor's recommendation should follow the applicable provisions of the Lead Safe Housing Rule (24 CFR 35.1355(b)(4)) for reevaluation at least as often as every two years.

If the property is not HUD-assisted, and lead hazards were identified, the risk assessment report should recommend reevaluation after completion of interim controls, encapsulation or enclosure of the lead hazards identified, unless all of the lead-based paint is to be removed and the housing passes a clearance examination. (If the risk assessor determines that soil-lead hazards may pose an ongoing health risk after the removal of the lead-based paint, the report may recommend reevaluation of the soil.)

If the property is not HUD-assisted, and no lead hazards were identified by the risk assessment, the report should recommend a visual assessment annually and at occupant turnover, with reevaluation an option, based on the owner's lead hazard control policy.

See Section VII.B and C, below, for the main discussion of reevaluation, including the reevaluation schedule and protocol, respectively.

D. Recommendations to Owners When No Hazards Are Identified

If no lead hazards are identified, but no lead-based paint inspection has been completed, the risk assessment report should recommend to the owner that painted surfaces that the risk assessment found to be lead-based paint, and any untested painted surfaces, be treated as though they contain lead.

The risk assessor may encourage the owner to obtain an inspection, especially for a property constructed shortly before 1978, because the property will be exempt from Federal lead-based paint regulations if the lead-based paint shows that no lead-based paint is present. In the absence of an inspection, the risk assessor should indicate that lead hazards could still emerge in the event of paint deterioration or disturbance.

E. Report Format

The following is a suggested format for risk assessment reports. Other formats are acceptable, provided the necessary information is included. Items required by EPA regulations (40 CFR 745.227(d)(11)) are indicated as "EPA-required."

1. Executive Summary

It is recommended that a brief summary of the essential findings of the risk assessment be provided at the beginning of the report. This is helpful for all clients, but is especially useful for rental housing receiving Federal housing assistance, because HUD regulations require that tenants of such housing be notified of the results of a risk assessment (24 CFR 35.125). The HUD-required notification may be in the form of a summary and may be posted in a central place or distributed to individual units. The format of the executive summary provided at Form 5.7 meets the HUD requirements.

2. Table of Contents

To assist the reader in finding the information needed, reports should include a table of contents highlighting the key sections of the report.

3. Identifying Information and Risk Assessor's Signature (EPA-required)

The following information is required. Items in executive summary need not be repeated.

- ◆ Date of risk assessment.
- ◆ Address of each building.
- ◆ Year of construction of buildings.
- ◆ Apartment number (if applicable).
- ◆ Name, address, and telephone number of each owner of each building and each building manager.
- ◆ Name, address, and telephone number of the certified firm employing each certified risk assessor (if applicable).
- ◆ Name, address, and telephone number of each recognized laboratory conducting analyses of collected samples.
- ◆ Name, signature, and certification of the certified risk assessor conducting the risk assessment.

4. Purpose of This Risk Assessment

The report should contain a brief explanation of the purpose of the investigation, including the following:

- a. Definition of a risk assessment
- b. Explanation of why this risk assessment was performed. Some common reasons include:
 - An investigation of sources of exposure of a child with an elevated blood-lead level (EBL),
 - Required for a federally-assisted rehabilitation,
 - Required for Federally owned housing being sold,
 - Required for a federally-assisted multi-family property,
 - Required for a public housing development,
 - Requested by an owner or a prospective buyer of a home.
- c. Description of any special requests by client.

5. Definitions

It is suggested that providing definitions of at least the terms below will be useful to owners so that they should be provided in the report. Risk assessors may wish to use the definitions in the Glossary of these *Guidelines*, (see Appendix 8.1, where these definitions are provided in the sample report) or the regulatory and/or statutory definitions for these terms. Risk assessors should note that, if lead-based paint, or lead hazard standards of an applicable EPA-authorized state, tribal or local program are more protective (e.g., have lower values) differ from federal standards, those applicable standards should be substituted for the values in the hazard definitions provided below.

- ◆ Abatement
- ◆ Bare soil
- ◆ Chewable surface
- ◆ Clearance examination
- ◆ Deteriorated paint
- ◆ Dripline/foundation area
- ◆ Dust-lead hazard
- ◆ Friction surface
- ◆ Garden area
- ◆ Impact surface
- ◆ Interim controls
- ◆ Lead-based paint
- ◆ Lead-based paint hazard
- ◆ Paint-lead hazard
- ◆ Play area
- ◆ Soil-lead hazard

6. Description of Lead-Based Paint Hazards and Acceptable Hazard Control Options (EPA-required)

EPA regulations require that the risk assessment report includes hazard control options and prioritization for addressing each hazard. It is suggested that the hazards and control options be described in a format similar to that shown in Tables 5-13 to 5-15, below, in order to help the owner prepare a work write-up.

Table 5.13 Paint-Lead Hazards.

Room or Exterior Location	Component	Type of Hazard	Approximate Area or Length	Quantity	Acceptable Hazard Control Options	
					Interim	Abatement

Table 5.14 Soil-Lead Hazards.

Type of Area	Location	Approximate Area of Bare Soil	Acceptable Hazard Control Options	
			Interim	Abatement

Table 5.15 Dust-Lead Hazards.

Room	Surface	Acceptable Hazard Control Method

7. Recommendations for Maintenance and Monitoring (EPA-required)

Recommendations for maintenance and monitoring of lead-based paint hazard controls should include the following:

- ◆ Recommendations for lead-safe maintenance, based on Chapter 6.
- ◆ The reevaluation schedule, if required, based on Section VII, below.

8. Additional Recommendations for Management (optional)

Additional recommendations for owners and managers of a multi-family property may include:

- ◆ Recommendations for notification of residents of results of the risk assessment and of scheduled follow-up hazard controls (Note that risk assessments (and lead hazard screens) of federally-assisted target housing require that residents be notified of the results within 15 calendar days. (24 CFR 35.125(a).)
- ◆ An overarching lead-based paint policy statement, describing the owner’s strategy and long-term goals for preventing lead exposures.
- ◆ A lead hazard control plan (see Chapter 11), with a strategy for prioritizing control of lead-based paint hazards that may be identified in the future (i.e., after the current hazards are controlled).
- ◆ A training plan for maintenance workers.
- ◆ Changes to the work order system to incorporate lead-safe maintenance practices.

9. Supporting Information (EPA-required)

Supporting information should be presented as a description of findings, based on data collection forms used in the field and laboratory reports, or copies of the field forms and reports themselves can be included. In either case, the original field forms and laboratory reports should be retained for at least three years. The following information must be provided:

- ◆ Results of Questionnaire for a Lead Hazard Risk Assessment (from either Form 5.0 or 5.6).
- ◆ Results of building condition survey (from Form 5.1).
- ◆ Description of the process used to select dwelling units and common areas for sampling, if unit sampling was performed in a multi-family development.
- ◆ Results of visual assessment of both paint and soil (from forms 5.2 and 5.5 and site-plan sketch). Make sure there is a record of where deteriorated paint and bare soil were observed.
- ◆ Location designation system used for sides, walls, and components.
- ◆ Testing methods used to determine the levels of lead in paint and the results of each XRF reading and paint chip sampling. Provide the serial number of any XRF device used.
- ◆ Analysis of previous lead-based paint inspection report (if applicable).
- ◆ Dust sampling results (from Form 5.4a or 5.4b, or from laboratory report).
- ◆ Paint testing results (both XRF and paint chip sampling, the latter from Form 5.3).
- ◆ Soil Sampling results (from Form 5.5 or from laboratory report).
- ◆ Other sampling results, if applicable.

VII. Reevaluation

A. Purpose and Applicable Properties

In general terms, a reevaluation is a risk assessment that is performed to provide the owner with independent, professional documentation of whether ongoing monitoring and maintenance are keeping dwellings free of lead-based paint hazards or, if not, what actions should be taken. The reevaluation should be conducted by a certified risk assessor and should include:

- (1) a review of prior reports to determine where lead-based paint and lead-based paint hazards have been found, what controls were done, and when these findings and controls happened;
- (2) a visual assessment to identify deteriorated paint, failures of previous hazard controls, visible dust and debris, and bare soil;
- (3) testing for lead in dust, newly deteriorated paint, and newly bare soil; and
- (4) a report describing the findings of the reevaluation, including the location of any lead-based paint hazards, the location of any failures of previous hazard controls, and, as needed, acceptable options for the control of hazards, the repair of previous controls, and modification of monitoring and maintenance practices.

The risk assessor should recommend reevaluation if the property is not HUD-owned or -assisted, if it was built before 1960, and if lead-based paint hazards have been found and treated with interim controls. Reevaluations are recommended for properties that are not HUD-owned or -assisted, built before 1960, and in which lead-based paint hazards have been found by a risk

assessor and treated with interim controls or, if no risk assessment has been performed, standard treatments have been conducted. If the property is HUD-owned or –assisted, the risk assessor’s recommendation should follow the applicable provisions of the Lead Safe Housing Rule (24 CFR 35, subparts B–R); the applicable provisions depend on the type and, in some cases, the amount of HUD assistance.

Only 11 percent of the housing units built between 1960 and 1977 have significant lead-based paint hazards compared to 39 percent for those built between 1940 and 1959 and 67 percent for pre-1940 housing, according to a survey conducted in 2005-2006. (HUD, 2011) (See also Jacobs, 2002, for which the percentages for a similar survey conducted in 1998-1999 were 8, 43, and 68, respectively.) Furthermore, research has found that reaccumulation of lead in dust after paint-lead hazards have been controlled is usually very slow, even in very old housing (NCHH, 2004). Therefore reevaluations are generally not cost effective for properties built after 1959, although ongoing visual monitoring and lead-safe maintenance are strongly recommended for all pre-1978 housing known or presumed to contain lead-based paint. Also, reevaluation is not needed for properties of any construction period for which an initial risk assessment has found no lead-based paint hazards, provided visual assessment and ongoing lead-safe maintenance are performed in accordance with these *Guidelines*. Although such properties may contain lead-based paint, the likelihood is small that hazards will appear if correct monitoring and maintenance practices are followed. Finally, reevaluation is not required for properties that have had all lead-based paint abated (i.e. permanently eliminated in accordance with EPA regulations). This is true even if lead-based paint has been enclosed or encapsulated, provided ongoing visual monitoring and lead-safe maintenance are performed as recommended in these *Guidelines*. Failures of encapsulations or enclosures can be identified by visual observation.

B. Reevaluation Schedule

If the property is HUD-assisted, the reevaluation schedule should follow the applicable provisions of the Lead Safe Housing Rule (24 CFR 35.1355(b)(4)) for reevaluation at least every two years.

If the property is not HUD-assisted, and lead hazards were identified, the reevaluation schedule should include:

- ◆ A visual assessment annually and at occupant turnover, and
- ◆ Reevaluation:
 - No later than two years after completion of interim controls, encapsulation or enclosure of the lead hazards identified by the risk assessment; with
 - Subsequent reevaluations conducted at intervals of two years, plus or minus 60 days; but
- ◆ Reevaluation is generally not needed after:
 - Two consecutive reevaluations are conducted two years apart without finding a lead-based paint hazard; or
 - All of the lead-based paint has been removed and the housing has passed a clearance examination; but

- If the risk assessor determined that soil-lead hazards may pose an ongoing health risk after the removal of the lead-based paint, the reevaluation schedule should include reevaluation of the soil.

If the property is not HUD-assisted, and no lead hazards were identified by the risk assessment, the owner should conduct (using trained staff or contractors):

- ◆ A visual assessment annually and at occupant turnover, and
- ◆ Optionally, reevaluation, based on the owner's lead hazard control policy.

C. Reevaluation Protocol

Reevaluations determine if the following conditions have reappeared:

- ◆ Leaded-dust above applicable standards.
- ◆ Deteriorated paint films with lead-based paint.
- ◆ Lead-based paint on friction, impact, and chewable surfaces.
- ◆ Deteriorated or failed interim controls, or encapsulant or enclosure treatments.
- ◆ New bare soil with lead levels above applicable standards.

These conditions can be detected through a visual assessment and limited dust, paint and soil sampling.

The procedure for a reevaluation is similar to that of a risk assessment, as described in this chapter, but is different in two important respects. First, data on the presence of lead in paint and soil may be available from a prior risk assessment or lead-based paint inspection. If so, the risk assessor should use such information to the extent possible and minimize the cost of additional testing. Secondly, existing lead hazard controls may be in place, and, if so, they must be visually examined to determine whether they are still performing as designed or whether repairs or improvements are needed.

1. Review of Prior Reports

The certified risk assessor conducting the reevaluation should begin by reviewing any past risk assessment, lead-based paint inspection, and reevaluation reports and any available information on lead hazard controls in existence at the time of the reevaluation, including but not limited to paint stabilizations, window and door treatments, encapsulations and enclosures of painted surfaces, and interim controls of soil-lead hazards. These reports, if properly prepared, should provide a list of previous lead-based paint hazards and lead hazard controls, which the risk assessor will be able to revisit during the visual assessment phase of the reevaluation. Risk assessor should identify the prior reports and indicate the extent to which they were used for this assessment.

2. Visual Assessment

A careful visual assessment should be conducted to identify:

- ◆ All known existing paint-lead hazard control measures that have failed. Examples of possible failures include, but are not limited to, an encapsulant that is peeling away from the wall, a painted surface that is no longer stabilized, or an enclosure that has been breached. Findings should be recorded on Form 5.2, or similar form, along with notes on the nature and scope of needed repairs. If any lead hazard control measure is failing, the risk assessor conducting the reevaluation should identify acceptable options for controlling the hazard, taking into account the likely cause of the failure.
- ◆ All deteriorated paint on untreated components that is known or presumed to be lead-based paint. Findings should be recorded on Form 5.2, or similar form, along with notes as to the probable cause (including but not limited to friction, impact, and moisture).
- ◆ Any chewable surfaces with evidence of teeth marks, if a child under 6 years of age lives in the unit. Record findings on Form 5.2, or similar form.
- ◆ All existing soil-lead hazard controls, to identify bare soil that indicates controls that have failed. Each controlled play area and non-play area should be examined for bare soil. Findings from visual assessments of soil should be recorded on Form 5.2, or similar form. If soil is tested, the sampling information and test results should be recorded on Form 5.5, or similar form.
- ◆ All bare soil in play areas and other yard areas that have not been previously treated, to identify bare soil in locations that are known or presumed to contain lead in soil exceeding applicable soil-lead hazard standards. Findings should be recorded on Form 5.5 or similar form.

3. Dust Sampling

Dust sampling should be conducted in accordance with procedures described in Section II.E, above. Results should be reported on Form 5.4a (for single-surface sampling) and/or 5.4b (for composite sampling), or similar form.

4. Testing Deteriorated Paint and Bare Soil for Lead

If possible, the risk assessor should use information from previous past lead-based paint inspections or risk assessments to discover whether any of the surfaces known to contain lead-based paint are now in a deteriorated condition or whether any soil known to have lead exceeding applicable standards is now bare. If relevant data from prior inspections or risk assessments are unavailable, the assessor should test the deteriorated paint and bare soil for lead, using methods described above in Sections II.F and II.G, respectively. Findings should be reported on Form 5.2 for XRF readings, Form 5.3 for results of paint chip sampling, or Form 5.5 for samples of bare soil, or similar forms.

5. Reevaluation Report

The risk assessor conducting the reevaluation should produce a report that:

- ◆ Documents the presence or absence of lead-based paint hazards.
- ◆ Identifies any lead hazards previously detected and controlled and the effectiveness of these interventions.
- ◆ Describes any new hazards, with suggested hazard control options.
- ◆ Identifies when the next reevaluation should occur, if it is needed in accordance with the schedule described in Section VII.B, above.
- ◆ Recommends a visual assessment annually and at occupant turnover, whether or not reevaluation is conducted.
- ◆ If the report is for rental property(ies), includes a summary of the report for use in notifying occupants of the results of the reevaluation.

6. Sampling in Multi-family Dwellings

Reevaluations in multi-family dwellings should target different units than those sampled previously. Worst-case sampling or random sampling, discussed in Section III.B, above, should be used for this purpose.

Form 5.0 Questionnaire for a Lead Hazard Risk Assessment of an Individual Occupied Dwelling Unit.

(Page 1 of 2)

(To be completed by risk assessor via interview with owner-occupant or, if a rental unit, an adult resident and, for questions 15 & 16, the owner.)

Property address _____

Apt. No. _____ Unit is Owner occupied Renter occupied

Year of construction _____ Prior LBP testing? Yes No

Name of owner interviewed _____ Owner interview date: ___/___/___

Name of resident interviewed (if rental unit) _____ Interview date: ___/___/___

Name of risk assessor _____

Children and Children’s Habits

1. Do any children under age 6 live in the home or visit frequently? Yes No

(If no children under age 6, skip to Question 5.)

2. If yes, how many? _____

3. Please provide the following information about each child under 6 to the extent you can.

	Child 1	Child 2	Child 3	Child 4
(a) Age:				
(b) Blood lead level :				
(c) Month/year of blood lead test:				
(d) Location of bedroom:				
(e) Main room where child eats:				
(f) Main room where child plays:				
(g) Main room where toys are stored:				
(h) Main locations where child plays outdoors:				

(If a resident child under age 6 has had an elevated blood lead level, an environmental investigation may be necessary [see Chapter 16 of the HUD Guidelines].)

4. (a) Do any children tend to chew on any painted surfaces, such as interior window sills? Yes No

(b) If yes, where? _____

**Form 5.0 Questionnaire for a Lead Hazard Risk Assessment
of an Individual Occupied Dwelling Unit.**

(Page 2 of 2)

Property address _____ Apt. No. _____

Other Household Information and Family Use Patterns

5. Do women of child-bearing age live in the home? Yes No
6. If this home is in a building with other dwelling units, what common areas in the building are used by children?

7. (a) Which entrance is used most frequently? _____
 (b) What other entrances are used frequently? _____

8. Which windows are opened most frequently? _____

9. (a) Do you use window air conditioners?* Yes No
 (b) If yes, where? _____

**Condensation underneath window air conditioners often causes paint deterioration.*

10. (a) Do you or any other household members garden? Yes No
 (b) If yes, where is the garden? _____

11. (a) Are you planning any landscaping activities that will remove grass or ground covering? Yes No
 (b) If yes, where? _____

12. (a) Which areas of the home get cleaned regularly? _____
 (b) Which areas of the home do not get cleaned regularly? _____

13. (a) Are any household members exposed to lead at work? Yes No
 (If no, go to question 14.)
- (b) If yes, are dirty work clothes brought home? Yes No
 (c) If they are brought home, who handles dirty work clothes and where are they placed and cleaned?

14. (a) Do you have pets? Yes No
 (b) If yes, do these pets go outdoors? _____

Building Renovations

15. (a) Were any building renovations or repainting done here during the past year? Yes No
 (b) If yes, what work was done, and when? _____
 (c) Were carpets, furniture and/or family belongings present in the work areas? Yes No
 (d) If yes, which items and where were they? _____
 (e) Was construction debris stored in the yard? Yes No
 (f) If yes, please describe what, where and how was it stored. _____
16. (a) Are you conducting or planning any building renovations? Yes No
 (b) If yes, what work will be done, and when? _____

Form 5.1 Building Condition Form for Lead Hazard Risk Assessment.

Property address _____ Apt. No. _____

Name of property owner _____

Name of risk assessor _____ Date of assessment: ____ / ____ / ____

Condition	Yes	No	Comments
Roof missing parts of surfaces (tiles, boards, shakes, etc.)			
Roof has holes or large cracks			
Gutters or downspouts broken			
Chimney masonry cracked, bricks loose or missing, obviously out of plumb			
Exterior or interior walls have obvious large cracks or holes, requiring more than routine pointing (if masonry) or painting			
Exterior siding has missing boards or shingles			
Water stains on interior walls or ceilings			
Walls or ceilings deteriorated			
More than "very small" amount of paint in a room deteriorated			
Two or more windows or doors broken, missing, or boarded up			
Porch or steps have major elements broken, missing, or boarded up			
Foundation has major cracks, missing material, structure leans, or visibly unsound			
** Total number			

* The "very small" amount is the *de minimis* amount under the HUD Lead Safe Housing Rule (24 CFR 35.1350(d)), or the amount of paint that is not "paint in poor condition" under the EPA lead training and certification ("402") rule (40 CFR 745.223).

** If the "Yes" column has any checks, the dwelling is usually considered not to be in good condition for the purposes of a risk assessment, and conducting a lead hazard screen is not advisable. However, specific conditions and extenuating circumstances should be considered before determining the final condition of the dwelling and the appropriateness of a lead hazard screen. If the "Yes" column has any checks, and a lead hazard screen is to be performed, describe, below, the extenuating circumstances that justify conducting a lead hazard screen.

Notes (including other conditions of concern):

Form 5.2 Report of Visual Assessment (for Lead Hazard Risk Assessment).
Form 6.0 Report of Visual Assessment (for Ongoing Lead-Safe Maintenance).

Property address _____ Apt. No. _____ Page ____ of ____

Name of property owner _____

Name of risk assessor _____ Date of assessment ____ / ____ / ____

Location of Building Component, Dust or Bare Soil	Building Component, Dust, or Bare Soil Play Area/ Non-Play Area	Area (sq. ft.)	Deteriorated Paint		Friction or Impact Surface? (F or I)	Visible Teeth Marks? (Y or N)	Paint Testing Results ⁴	Notes [e.g., paint testing (e.g., XRF, lab analysis) indicates paint is or is not lead-based paint; cause(s) of hazard control failures]
			Is Area Small? ² (Y or N)	Probable Cause(s) of Deterioration if Known ³				

¹Include room equivalent or exterior side or wall, as appropriate.
²Lead-safe work practices and clearance/cleaning verification are not required if work does not disturb painted surfaces that total more than
 ◆ For assisted housing: HUD's *de minimis* area of: 20 ft² or less on exterior surfaces, 2 ft² or less in any one interior room or space, or 10 percent of the total surface area on an interior or exterior type of component with a small surface area (such as trim, window sills, baseboards);
 ◆ For unassisted housing, and for child-occupied facilities, EPA's minor repair and maintenance activities threshold of: 6 ft² or less per room; or 20 ft² or less for exterior activities; provided that no prohibited or restricted work practices were used and no window replacement or demolition of painted surface areas is to be done.
³Common causes of paint deterioration are: moisture (indicate source if apparent), mildew, friction or abrasion, impact, damaged or deteriorated substrate, and severe heat.
⁴If paint testing results are obtained on site, use this column to record the result. If a paint chip sample is sent to the laboratory, use this column to record the sample number (or other unique identifier) as a reference to another record containing the sampling data and laboratory results.

Form 5.4a Field Sampling Form for Dust. (Single-Surface Sampling)

(Use a separate form for each housing unit, common area, or exterior. Sample all layers of paint, not just deteriorated paint layers.) Page ____ of ____

Property address _____

Name of property owner _____ Apt. No. _____ Common Area, Housing Unit, or Exterior No. _____

Name/Firm of risk assessor _____ Date of assessment ____/____/____

Sample Number	Room or Entryway	Surface Type ¹	Exact Location of Wipe Sample	Is surface smooth & cleanable?	Sample Area ² (inches x inches)	Sample Area ³ (ft ²)	Lab Result ⁴ (µg/ft ²)	Notes

¹ Hard Floor (HF), Carpeted Floor (CF), or Interior Window Sill (S)
² Measure to the nearest 1/8th or 1/10th of an inch. [1/8 = 0.125, 2/8 = 0.25, 3/8 = 0.375, 4/8 = 0.5, 5/8 = 0.625, 6/8 = 0.75, 7/8 = 0.875]
³ Calculate sample area in square feet as follows: Calculate square inches, then divide by 144.
⁴ Provide areas, direct laboratory to report the dust lead result in µg/ft².
 NOTE: EPA standards: 40 µg/ft² (interior floors); 250 µg/ft² (interior window sills) for Risk Assessment; 25 µg/ft² and 125 µg/ft² for screen.

Total number of samples on this page ____ Date of sample collection ____/____/____

Shipped to lab by ____/____/____ (signature and date)

Received by ____/____/____ (signature and date)

Reviewed by ____/____/____ (signature and date)

Date results reported by lab ____/____/____ Reviewed by ____/____/____

Form 5.4b Field Sampling Form for Dust. (Composite Sampling)

Property address _____ Page _____ of _____

Name of property owner _____ Apt. No. _____ Common Area, Housing Unit, or Exterior No. _____

Name/Firm of risk assessor _____ Date of assessment ____/____/____

Sample Number	Type of Surface	Location of Subsamples		Is surface smooth and cleanable?	Area of Each Surface Sampled ¹ (inches x inches)	Total Surface Area Sampled ² (ft ²)	Lab Result ³ (µg/ft ²)	Notes
		Room	Exact Location on Component					
	Hard floors				<input type="checkbox"/> x ____ <input type="checkbox"/> x ____ <input type="checkbox"/> x ____ <input type="checkbox"/> x ____			
	Carpeted floors				<input type="checkbox"/> x ____ <input type="checkbox"/> x ____ <input type="checkbox"/> x ____ <input type="checkbox"/> x ____			
	Interior sills				<input type="checkbox"/> x ____ <input type="checkbox"/> x ____ <input type="checkbox"/> x ____ <input type="checkbox"/> x ____			
	Entryway				<input type="checkbox"/> x ____			

¹ Measure to the nearest 1/8th or 1/10th of an inch. [1/8 = 0.125, 2/8 = 0.25, 3/8 = 0.375, 4/8 = 0.5, 5/8 = 0.625, 6/8 = 0.75, 7/8 = 0.875]
² Calculate sample area in square feet as follows: Calculate square inches for each surface sampled, add together, then divide total by 144.
³ Provide areas, direct laboratory to report the dust lead result in µg/ft².

NOTE: EPA standards: 40 µg/ft² (interior floors); 250 µg/ft² (interior window sills) for Risk Assessment; 25 µg/ft² and 125 µg/ft² for screen.

Total number of samples on this page _____ Date of sample collection ____/____/____

Shipped to lab by _____ (signature and date)

Received by _____ (signature and date)

Reviewed by _____ (signature and date)

Date results reported by lab ____/____/____ Reviewed by ____/____/____

Form 5.5 Field Sampling Form for Soil.

(Composite sampling only. Use a separate form for each residential building in a multi-building property.)

Page _____ of _____

Name of owner _____ Name of risk assessor _____ Date of completion of this form ____/____/____

Type of Area Sampled	Sample Number	Location of Composite Sample(s)	Approximate Area of Bare Soil Represented by Composite Sample (ft. ²)	Laboratory Result (ppm or µg/g)
Bare Soil in Play Areas				
Bare Soil in Non-play Areas in Dripline/Foundation Area				
Bare Soil in Non-play Areas in the Rest of the Yard				

NOTE: EPA hazard standard for bare play area soil is 400 ppm or µg/g; for bare non-play area soil is 1,200 ppm or µg/g.

Total number of samples on this page _____ Date of sample collection ____/____/____

Shipped to lab by ____/____/____ (signature and date)

Received by ____/____/____ (signature and date)

Reviewed by ____/____/____ (signature and date)

Date results reported by lab ____/____/____ Reviewed by ____/____/____

Form 5.6 Questionnaire for a Lead Hazard Risk Assessment of More Than Four Rental Dwelling Units. Page 1 of 4

(This form is designed for multiple rental dwellings under one ownership. Such dwellings may be in one or more than one property.)

Name of owner _____

Name of risk assessor _____ Date of completion of this form ____/____/____

1. Information on Properties (Attach list if there are more than 4 properties.)

Property Address	Name of Development (if applicable)	Year Built	Year of Substantial Rehabilitation	No. of Buildings	No. of Dwelling Units	Previous LBP Evaluation? (If yes, obtain report)	Previous LBP Hazard?(If yes, obtain report)	Code Violation Reports? (If yes, obtain report)

2. Information for Targeted Sampling (Attach list if there are more than 10 dwelling units. It is not necessary to complete the following table if not using targeted sampling. Refer to Chapter 7 for guidance on random sampling.)

Property Address (For units at same address, enter address once, and enter ditto marks or down- arrow.)	Dwelling unit no.	No. of children < 6 years old	Code violations in past year?	Chronic maintenance problem reported by owner?	Recently prepared for reoccupancy?	Comments

3. Information on Interior Common Areas (Attach list if more room needed.)

Property Address (For common areas at same address, enter address once, and enter ditto marks or down- arrow.)	Interior Common Area Name/Location	Frequented by a Child < 6 Years Old?	Comments

4. Information on Play Areas with Bare Soil (Attach list if more room needed. Obtain information on play areas for all properties. Record the total number of play areas and the location of each common child play area in onsite playgrounds, back-yards, etc.)

Total number of play areas with bare soil: _____

Property Address (For play areas at same address, enter address once, and enter ditto marks or down- arrow.)	Description of Each Play Area and Its Location (Identify each play area with a code number within each property, and show code number on site plan sketch(es))

**Form 5.6 Questionnaire for a Lead Hazard Risk Assessment
of More Than Four Rental Dwelling Units.**

5. Management Information (Optional)

- a. 1) Attach a list of names and contract information for individuals who have responsibility for lead-based paint. Include owner, property manager (if applicable), maintenance supervisor and staff (if applicable), and others. Include any training in lead hazard control work (by inspector, supervisor, worker, etc.) that has been completed. This information will be needed to devise the management plan contained in the risk assessor's report.
- 2) Is the property owner or property management firm (if separate) a certified lead renovation firm? Yes No
(If yes, list the name of each certified firm and the expiration date of its renovation firm certification.)

b. Maintenance usually conducted at time of dwelling turnover, including typical cleaning, repainting, and repair activity:

Repainting _____

Cleaning _____

Repair _____

Other _____

Comments _____

c. Employee and worker safety plan.

- 1) Is there an occupational safety and health plan for maintenance workers? Yes No (If yes, attach plan.)
- 2) Are any employees certified lead renovators or certified lead abatement supervisors? Yes No
(If yes, list, for each certified individual, the person's name, type of certification and certification expiration date.)
- 3) If answer 2 is "No," Are workers trained in lead hazard recognition? Yes No (If yes, what was the title, and who did the training?)
- 4) Are workers involved in a lead hazard communication program? Yes No (If yes, attach plan.)
- 5) Are workers trained in proper use of respirators? Yes No
- 6) Is there a medical surveillance program pertaining to lead? Yes No
- 7) Is a HEPA vacuum available? Yes No

d. On-site child care center facilities.

- 1) Are there any onsite child-care facilities, whether licensed or unlicensed? Yes No
- 2) If yes, give location(s): _____

e. Planning for resident children with elevated blood lead levels (EBLs):

- 1) Who would respond for the owner if a resident child with an EBL is identified? _____
- 2) Is there a plan to relocate such children? Yes No If yes, where? _____
- 3) Does the owner know if there ever has been a resident child with an elevated blood lead level? Yes No Unknown

f. Routine Inspections. Are there periodic inspections of all dwellings by the owner? Yes No

- 1) If yes, how often? _____
- 2) Is the paint condition assessed during these inspections? Yes No

g. Notification of Residents. If previously detected lead-based paint that is unabated exists in the dwelling, have the residents been informed?

- Yes No Not Applicable

**Form 5.6 Questionnaire for a Lead Hazard Risk Assessment
of More Than Four Rental Dwelling Units.**

6. Maintenance Information (Optional)

- a. Painting frequency and methods /
- 1) How often is painting completed? Every _____ years
 - 2) Is painting completed upon vacancy, if necessary? Yes No
 - 3) Who does the painting? Property Owner Residents (if residents, skip to Question b.)
 - 4) Is painting accompanied by scraping, sanding, or paint removal? Yes No
 - 5) How are paint dust/chips cleaned up? (check any that apply)
 Sweeping Vacuum Mopping HEPA/wet wash/HEPA cycle
 - 6) Is the work area sealed off during painting? Yes No
 - 7) Is furniture removed from the work area? Yes No
 - 8) If no, is furniture covered with plastic during work? Yes No
- b. Is there a preventive maintenance program? Yes No
- 1) If yes, does it include an ongoing maintenance program for lead? Yes No (If yes, attach ongoing maintenance plan for lead.)
- c. Describe work order system (if applicable, attach copy of work order form).
- d. How are resident complaints received and addressed? How are requests prioritized? If formal work orders are issued, is the presence or potential presence of lead-based paint considered in the work instructions?

Form 5.7 Format for an Executive Summary of a Lead Hazard Risk Assessment. Page 1 of 2

Property address _____ Date of risk assessment ____ / ____ / ____
 Building or Apt. Designation _____

Summary of Results: (either) No lead-based paint (LBP) hazards were found -or- Lead-based paint (LBP) hazards were found; below is a summary of findings.

Paint-Lead Hazards: (if applicable)

Unit Number Common Area, or Exterior Location	Room or Room Equivalent	Building Component	Type of Hazard*	Lead Level (mg/cm ² or µg/g)**	Options for Corrective Action

* LBP on friction surface with dust-lead hazard beneath, impact surface, chewable surface with teeth marks, or other deteriorated LBP.

** Milligrams per square centimeter (mg/cm²), or micrograms per gram (µg/g; parts per million; ppm).

NOTE: EPA standard for LBP: 1.0 mg/cm², or 5,000 µg/g.

Dust-Lead Hazards: (if applicable)

Unit Number or Common Area	Room or Room Equivalent	Surface*	Lead Level (µg/ft ²)**	Options for Corrective Action

* Floor, or interior window sill. ** Micrograms per square foot (µg/ft²)

NOTE: EPA dust-lead hazard standards: 40 µg/ft.² (floors); 250 µg/ft.² (interior window sills).

Summary of Results: Soil-Lead Hazards (bare soil only): (if applicable)

Type of Area*	Location	Lead Level (ppm or µg/g)**	Options for Corrective Action

* Play area, dripline/foundation area, or rest of the yard. ** Parts per million, or micrograms per gram. EPA standards: 400 ppm (play areas); 1,200 ppm (non-play areas in the dripline/foundation area or the rest of the yard).

Form 5.7 Format for an Executive Summary of a Lead Hazard Risk Assessment.

Property address _____ Date of risk assessment ____/____/____

Building or Apt. Designation _____

Intact Paint Surfaces With Lead-Based Paint: (if client has requested additional testing)

Unit Number, Common Area, or Exterior Location	Room or Room Equivalent	Building Component	Lead Level (mg/cm ²)*	Options for Corrective Action

* NOTE: EPA standard for LBP: 1.0 mg/cm², or 5,000 µg/g.

Contact Person for Further Information (name, address, phone number) _____

Person Who Prepared This Summary (printed name, firm/agency, address, phone number, state/EPA RA certification number and expiration date) _____

Signature of Preparer and date _____/____/____

References

Ashley, 2001. Ashley, K., Wise, T.J., Mercado, W., Parry D.B., Ultrasonic extraction and field-portable anodic stripping voltammetric measurement of lead in dust wipe sample. *Journal of Hazardous Materials*, 83: 41-50, 2001.

Battelle, 2002. Batelle Memorial Institute, "A Field Study Comparing the Use of Individual and Composite Dust-Wipe Samples for Risk Assessment and Clearance Testing," report prepared for the U.S. Department of Housing and Urban Development, Office of Healthy Homes and Lead Hazard Control.

Binstock, 2009. Binstock, D.A.; Gutknecht, W.F. McWilliams, A.C. "Lead in Soil - An Examination of Paired XRF Analysis Performed in the Field and Laboratory ICP-AES Results," *International Journal of Soil, Sediment and Water*. 2:2(1), 2009. <http://scholarworks.umass.edu/intljssw/vol2/iss2/>

CDC, 2002. Centers for Disease Control and Prevention, U.S. Department of Health and Human Services, *Managing Elevated Blood Lead Levels Among Young Children: Recommendations from the Advisory Committee on Childhood Lead Poisoning Prevention*, March 2002. http://www.cdc.gov/nceh/lead/casemanagement/casemanage_main.htm

Clark, 2002. Clark, C.S., "Development of a Rapid On-Site Method for the Analysis of Dust Wipes Using Field Portable X-Ray Fluorescence," prepared for the U.S. Department of Housing and Urban Development, January 2002.

Cohen, 1993. Cohen, J.T., "The Use of Monte Carlo Simulation Techniques To Predict Population Blood Lead Levels," Harvard Center For Risk Analysis, (Commonwealth of Massachusetts proposed amendments to Regulations for Lead Poisoning Prevention and Control, 105 CMR 460.000, Department of Public Health).

Dixon, 2004. Dixon, S.L., J.W. Wilson, P. Succop, M. Chen, W.A. Galke, W. Menrath, and C. Clark, "Residential Dust Lead Loading Immediately After Intervention in the HUD Lead hazard Control Grant Program" *Journal of Occupational and Environmental Hygiene*, 1: 716-724, 2004. DOI: 10.1080/15459620490520792.

EPA, 1989. U.S. Environmental Protection Agency, *Review of the National Ambient Air Quality Standards for Lead: Exposure Analysis Methodology and Validation*, EPA-450/2-89-011, Research Triangle Park, North Carolina.

EPA, 1994. U.S. Environmental Protection Agency, *Residential Sampling for Lead: A Process for Risk Assessment*, Westat, Rockville, Maryland

EPA, 1995b. U.S. Environmental Protection Agency, *A Field Test of Lead-Based Paint Testing Technologies: Technical Report*, EPA 747-R-95-002b, May 1995.

EPA, 2001b. U.S. Environmental Protection Agency, *Analysis of Lead Clearance Testing*, (EPA 747-R-01-005).

EPA, 2002a. U.S. Environmental Protection Agency, "Questions & Answers About ETV Reports on Portable Technologies for Measuring Lead in Dust," December 2002.

EPA, 2002b. U.S. Environmental Protection Agency, *The Environmental Technology Verification Program (ETV), Verification Statements EPA-VS-SCM-50, 51, 52, 53 and 54*. Prepared by Oak Ridge National Laboratory, Oak Ridge, Tennessee, August 2002.

EPA, 2004. U.S. Environmental Protection Agency, X-ray Fluorescence (XRF) Instruments. Frequently Asked Questions (FAQ). <http://epa.gov/superfund/lead/products/xrffaq.pdf>

Farfel, 1992. Farfel, M., Paper presented at Centers for Disease Control Conference, December 8, 1992 (unpublished).

Harper, 2002. Harper M, Hallmark TS, Bartolucci AA. A comparison of methods and materials for the analysis of leaded wipes. *J. Environmental Monitoring*, 4(6):1025-33, December 2002. <http://pubs.rsc.org/en/Content/ArticleLanding/2002/EM/b208456m>

HES, 1991. Housing Environmental Services, Housing Authority Risk Retention Group, *Lead-Based Paint Risk Assessment Protocol*, Cambridge, Massachusetts.

Finster, 2004. Finster, M.E., K.A. Gray, and H.J. Binns, "Lead levels of edibles grown in contaminated residential soils: a field survey," *Science for the Total Environment*, 320(2-3): 245-57.

HUD, 1992. U.S. Department of Housing and Urban Development, Office of Public Housing, "Notice of Fund Availability for Lead-Based Paint Risk Assessments," *Federal Register*, Vol. 57, No. 125: 2891028943.

HUD, 2011. U.S. Department of Housing and Urban Development, Office of Healthy Homes and Lead Hazard Control. American Healthy Homes Survey: Lead and Arsenic Findings. April 2011. http://portal.hud.gov/hudportal/documents/huddoc?id=AHHS_REPORT.pdf.

Jacobs, 1991a. Jacobs, D.E., *A Preliminary Evaluation of Commercially Available Lead-Based Paint Field Test Kits*, EPA Contract No. OD4913NAEX, Georgia Institute of Technology, Atlanta, Georgia, 1991.

Jacobs, 2002. Jacobs, D.E., R.P. Clickner, J.Y. Zhou, S.M. Viet, D.A. Marker, J.W. Rogers, D.C. Zeldin, P. Broene and W. Friedman, "The Prevalence of Lead-Based Paint Hazards in US Housing," *Environmental Health Perspectives*, 110(10): 599, October 2002. <http://www.ncbi.nlm.nih.gov/pubmed/12361941>

Jacobs, 2003. Jacobs, D.E., H. Mielke and N. Pavur, "The High Cost of Improper Removal of Lead-Based Paint from Housing: A Case Report," *Environmental Health Perspectives* 111 (2): 185-6. <http://ehp.niehs.nih.gov/members/2003/5761/5761.html>

Lanphear, 1996. Lanphear, B., M. Weitzman, N. Winter, S. Eberly, B. Yakir, M. Tanner, M. Emond, and T. Matte, "Lead-Contaminated House Dust and Urban Children's Blood Lead Levels," *American Journal of Public Health*, 86: 1416-14421, 1996. <http://ajph.aphapublications.org/cgi/reprint/86/10/1416.pdf>

NCHH, 2003. National Center for Healthy Housing, *Study of HUD's Risk Assessment Methodology in Three U.S. Communities: Final Report*, Prepared for U.S. Department of Housing and Urban Development, Washington, DC.

NCHH, 2004. National Center for Healthy Housing, and University of Cincinnati Department of Environmental Health, *Evaluation of the HUD Lead-Based Paint Hazard Control Grant Program: Final Report*, prepared for the U.S. Department of Housing and Urban Development, Washington, DC, May 1, 2004.

NDPA, 1990. National Decorating Products Association (now Paint & Decorating Retailers Association), *Paint Problem Solver (Fourth Edition)*, St. Louis, Missouri, 1990.

NIST, 2000. Rossiter, W.J., Jr., M. G. Vangel, M.E. McKnight and G. Dewalt, *Spot Test Kits for Detecting Lead in Household Paint: A Laboratory Evaluation*, National Institute of Standards and Technology, U.S. Department of Commerce, May 2000. NISTIR 6398. <http://fire.nist.gov/bfrlpubs/build00/PDF/b00034.pdf>

Rosen, 2002. Rosen, C.J., *Lead in the Home Garden and Urban Soil Environment, revised*. University of Minnesota Extension Service, FO-0243. <http://www.extension.umn.edu/distribution/horticulture/DG2543.html>

Sterling, 2000. Sterling DA, Lewis RD, Luke DA, Shadel BN. A portable x-ray fluorescence instrument for analyzing dust wipe samples for lead: evaluation with field samples. *Environmental Research*, 83(2):174-9, June 2000. <http://www.sciencedirect.com/science/article/pii/S0013935100940581>.

Tohn, 2000. Tohn, E.R., S.L. Dixon, D. Rupp and C.S. Clark, "A Pilot Study Examining Changes in Dust Lead Loadings on Walls and Ceilings after Lead Hazard Control Interventions," *Environmental Health Perspectives*, 105(5): 453-456, May 2000.

Westat, 2001. Westat, Inc., *National Survey of Lead and Allergens in Housing, Final Report, Volume I: Analysis of Lead Hazards*, U.S. Department of Housing and Urban Development, Washington, DC, April 2001. http://www.nmic.org/nycclp/documents/HUD_NSLAH_Vol1.pdf

Chapter 6: Ongoing Lead-Safe Maintenance

STEP-BY-STEP SUMMARY

ONGOING LEAD-SAFE MAINTENANCE: HOW TO DO IT	6-3
I. Introduction	6-7
II. Visual Assessment	6-9
A. Frequency and Scope	6-9
B. Information on Known Hazards and Existing Hazard Controls	6-10
C. Identifying Deteriorated Paint, Excessive Dust and Debris, and Failed Lead Hazard Controls	6-11
1. Training	6-11
2. Deteriorated Paint	6-11
3. Small Amounts of Paint	6-12
4. Visible Dust and Debris	6-13
5. Failed Lead Hazard Controls	6-13
6. Structural and Other Problems Causing Paint Deterioration and Hazard Control Failure	6-13
D. Identifying Chewable Surfaces	6-14
E. Identifying Bare Soil	6-14
F. Identifying Horizontal Surfaces that Are Not Smooth and Cleanable (Optional)	6-15
III. Ongoing Lead-Safe Maintenance Practices	6-16
A. Introduction	6-16
B. Ways in Which Maintenance Work Can Create or Intensify Lead Hazards	6-16
1. Paint Abrasion or Other Disturbance	6-16
2. Water Damage	6-17
3. Dust Exposures	6-17
4. Grounds Keeping	6-18
C. Elements of an Ongoing Lead-Safe Maintenance Program	6-18
1. Incorporate Lead-Safe Work Practices in All Paint-Disturbing Work	6-18
2. Stabilize Deteriorated Paint	6-21
3. Repair Failed Lead Hazard Controls	6-21
4. Clean-up Dust and Debris	6-21
5. Control Chewable Surfaces	6-22
6. Make Surfaces Smooth and Cleanable (Optional)	6-22
7. Inform Residents About Lead-Based Paint Hazards and Request Their Cooperation ...	6-22
8. Perform Clearance Examinations to Check Dust-Lead Levels	6-22
9. Addressing Bare Soil and Sandboxes.....	6-23
D. Qualifications of Firms, Workers, and Clearance Examiners	6-23
IV. Managing Ongoing Lead-Safe Maintenance	6-24
A. Determining the Scope of the Program	6-24

B. Assignment of Responsibilities	6-26
C. Description of Responsibilities	6-28
1. Managing Visual Assessments.....	6-28
2. Determining that Firms and Workers Are Qualified	6-28
3. Maintaining Records	6-29
4. Determining the Lead-Safe Work Practices To Be Used on Each Job	6-30
5. Modifying the Work Order System	6-30
6. Communicating with Residents	6-30
7. Purchasing Supplies and Equipment	6-31
8. Monitoring the Work and Arranging for Clearance Examinations	6-33
REFERENCES	6-42
FIGURES	
Figure 6.1 Visual Assessment.....	6-9
Figure 6.2 Opening screen from HUD’s first on-line visual assessment training curriculum. Updates may occur.....	6-11
Figure 6.3 An area of bare soil beneath a window with deteriorated paint.....	6-14
Figure 6.4 Bare soil in Figure 6.3 covered with mulch (the window was sealed during the process of controlling the bare soil).....	6-23
Figure 6.5 Unit turnover is an excellent time to conduct the visual assessment and perform lead-safe maintenance activities.....	6-27
Figure 6.6 Clean-up supplies.....	6-32
FORMS	
Form 6.0 Report of Visual Assessment (for Ongoing Lead-Safe Maintenance).....	6-35
Form 6.1 Report of Visual Assessment of Bare Soil for Lead-Safe Maintenance	6-36
Form 6.2 Log of Visual Assessments for Ongoing Lead-Safe Maintenance	6-37
Form 6.3 Lead-Based Paint Inventory.....	6-38
Form 6.3a Completed Lead-Based Paint Inventory for a Room/Space	6-39
Form 6.4 Lead Hazard Control Inventory	6-40
Form 6.5 Lead-Safe Maintenance Work Order	6-41

Chapter 6: Ongoing Lead-Safe Maintenance

Step-by-Step Summary

Ongoing Lead-Safe Maintenance: How to Do It

- 1. Managing a lead-safe maintenance program.** Whether they do the work personally, have their staff perform the maintenance work (in either case, the rental owners must become certified renovation firms and have the work supervised by a certified renovator), or use outside maintenance contractors, owners should develop a written program defining the scope and procedures of lead-safe maintenance that apply to each pre-1978 property and should assign responsibilities for carrying out the elements of the program. Maintenance workers should be trained in lead-safe work practices and should be instructed on how to perform these functions in conjunction with normal duties. The project supervisors for these maintenance workers must be certified renovators, and the firm performing the work –whether owner’s firm or the outside maintenance contractor – must be a certified renovation firm when the work may disturb lead-based paint in amounts above the EPA’s minor repair and maintenance activities threshold. Work order forms should be changed (if necessary) to include items in the lead-based paint maintenance work order form in this chapter. If no work order is used, owners should develop a system to inform maintenance project supervisors and maintenance workers when a job may involve a lead hazard or lead-based paint. For multi-family housing, the lead-safe maintenance program should be included in the Lead Hazard Control Plan discussed in Chapter 11.
- 2. Visual assessments.** Periodic visual assessments should be conducted to identify deteriorated paint, unusual amounts of visible dust, paint-related debris, and structural or other problems that may be causing some of those conditions. Visual assessments must be trained by individuals trained in performing them. Training in performing visual assessments is available on line on the HUD lead website, and in certain EPA lead safety courses, such as the risk assessment certification training. Also, the visual assessment should identify bare soil.

Visual assessments should be conducted at the following times:

 - ◆ Whenever the owner receives a resident complaint regarding paint deterioration or other potential lead hazard in a dwelling unit or common area.
 - ◆ Whenever the dwelling turns over or becomes vacant.
 - ◆ Whenever significant damage occurs (i.e., flooding, vandalism, fire).
 - ◆ At least once every year.
- 3. Maintain information on lead-based paint and lead hazard controls.** Before beginning work on a painted surface, determine whether it is known if lead-based paint is or is not present on the surface. If paint testing has *not* been conducted and the component was installed before 1978, presume lead-based paint is present, or have the paint tested.

If paint testing *has* been conducted on some or all surfaces on the property, it is recommended that owners and managers develop and keep up-to-date a ready-to-use list of surfaces that are known to

contain or not to contain lead-based paint, using an inventory form like that provided in this chapter (Form 6.3; this and all other forms in this chapter are at its end). Information on the presence or absence of lead-based paint should be based on testing by a certified lead-based paint inspector, risk assessor, or renovator, except that, as of the publication of this edition of these *Guidelines*, a spot test kit may not be used to determine the presence of lead-based paint. Also, if lead-based paint hazard controls have been conducted on the property, it is recommended that owners and managers maintain a similar list of lead-based paint hazard controls, if any have been conducted (Form 6.4).

4. **Determine resident protection and worksite preparation measures.** Before beginning a maintenance or renovation job that will disturb paint or soil, determine, based on the guidance provided in Chapter 8, what resident protection and worksite preparation measures should be implemented. If a written work order system is used, complete work order forms for each job, defining and documenting specific protective measures to be used (Form 6.5). Whether or not a written work order system is used, inform workers of the required protective measures.
5. **Educate residents before starting work.** The U.S. Environmental Protection Agency (EPA) requires that a person performing a paint-disturbing job for compensation, including staff of a housing development, must educate residents on lead-based paint hazards in the home and provide residents of each affected unit with a copy of the “Lead-Safe Certified Guide to Renovate Right” lead hazard information pamphlet or an EPA-approved State or Tribal alternative pamphlet. This education must occur within 60 days before beginning a maintenance or renovation job (<http://www.epa.gov/opptintr/lead/pubs/renovaterightbrochure.pdf>). This is required under the EPA’s “Pre-Renovation Education” Rule (40 CFR Part 745). It does not apply if the job is a “minor repair and maintenance activity” as defined by the EPA (or a State or Tribal authorized renovation certification program). Note that the EPA’s Pre-Renovation Education Rule is different from the EPA-HUD Lead-Based Paint Disclosure Rule, which requires that owners inform prospective tenants or buyers of any known lead-based paint and lead-based paint hazards on the property before the tenant is obligated under a lease or sales contract, and to provide the prospective tenants or buyers with a different lead hazard information pamphlet, *Protect Your Family From Lead In Your Home*, among other requirements (see Appendix 6).
6. **Conduct the work using lead-safe work practices.** Properly trained workers should correct problems found by visual assessments; these workers must be supervised by certified renovators working for certified renovation firms if the deteriorated paint being corrected is in amounts above the EPA’s minor repair and maintenance activities threshold. The workers should conduct all maintenance and renovation work in pre-1978 properties using lead-safe work practices, resident protection, and worksite preparation measures, in a manner consistent with Chapter 8 of these *Guidelines*. For a discussion of the applicable regulations, see Appendix 6.
7. **Do not use prohibited paint-removal practices.** Workers must not remove paint using the following methods in HUD-assisted housing; the last three are permitted in unassisted housing:
 - ◆ Open flame burning or torching.
 - ◆ Heat guns operating above 1100 degrees Fahrenheit or charring the paint.
 - ◆ Machine sanding or grinding without a HEPA local exhaust control.
 - ◆ Abrasive blasting or sandblasting without HEPA local exhaust control.

- ✦ Manual dry sanding or dry scraping, except dry scraping is acceptable in conjunction with heat guns operating at no more than 1100 degrees Fahrenheit or within one foot of electrical outlets or when treating defective paint spots totaling no more than 2 square feet in any one interior room or 20 square feet on exterior surfaces.
- ✦ Paint stripping in a poorly ventilated space when using a volatile stripper that is a hazardous substance in accordance with regulations of the Consumer Product Safety Commission (CPSC) at 16 CFR 1500.3(b)(4) (www.cpsc.gov/businfo/notices.html) or and/or a hazardous chemical in accordance with the OSHA regulations at 29 CFR 1910.1200 for 1926.59, as applicable to the work (www.osha.gov). Paint removers with methylene chloride should be avoided.

In addition, these *Guidelines* recommend strongly against the use of power washing or uncontained hydroblasting.

8. **Clean the work area and other work-related spaces.** After finishing the work, clean the following spaces in accordance with guidance provided in Chapters 8 and 14: work areas, spaces immediately adjoining the work areas, and passageways and storage spaces used by workers. Be sure to clean window troughs associated with the work area, as well as floors, interior window sills, and, for high-dust jobs, walls in the work area.
9. **Clearance examination.** Have a clearance examination performed in accordance with guidance in Chapter 15. Clearance is not required if the area of paint that was disturbed is no more than that specified in item 11, below, or if the work was conducted in unassisted housing under the EPA's Renovation, Repair, and Painting (RRP) Rule. Clearance examinations must be conducted by certified risk assessors, sampling technicians, or lead-based paint inspectors. Qualifications and requirements vary by State.
10. **Communicate with residents.** In rental housing, notify residents of the results of the clearance examination, if applicable, and of any other actual knowledge about lead-based paint and lead-based paint hazards obtained during the project. In HUD-assisted housing, this information must be communicated within 15 days after obtaining the clearance results. Urge residents to clean their units frequently to control dust accumulation. Ask residents to report occurrences of deteriorated paint, failed lead hazard controls (if applicable), and bare soil (if applicable), so that owners can promptly correct situations that are potential hazards.
11. **Consider the amount of paint disturbance.** HUD and EPA regulations do not require trained workers, lead-safe work practices or clearance/cleaning verification if the area of paint being disturbed is less than the applicable threshold area:
 - ✦ For HUD-assisted housing, HUD defines *de minimis* areas as: (a) 20 square feet (2 square meters) or less on exterior surfaces, (b) 2 square feet (0.2 square meters) or less in any one interior room or space, or (c) 10 percent or less of the total surface area on an interior or exterior component with a small surface area (such as window sills, baseboards, or other trim).
 - ✦ For unassisted housing, EPA defines minor repair and maintenance activities as those that disrupt 6 square feet or less of painted surface per room for interior activities or 20 square feet or less of painted surface for exterior activities where none of the work practices prohibited or restricted by 40 CFR 745.85(a)(3) are used (see unit II.C.3) and where the work does not involve window replacement or demolition of painted surface areas.

These *Guidelines*, however, strongly recommend that workers adhere to the following practices when disturbing any paint applied before 1978, even if lead-safe work practices are not required by regulation:

- (a) Never use HUD- or EPA-prohibited methods of paint removal, and
 - (b) If young children reside in the unit or frequent the common area, always keep residents out of the work area until after clean-up and workers have cleaned the work area and themselves thoroughly after finishing, and, when clearance or cleaning verification, when conducted, has been passed.
12. **Document all activities.** The results of visual assessments and any corrective measures taken should be documented, and such reports should be retained, especially in rental housing. Reports that document ongoing lead-safe maintenance may provide some degree of protection against charges of negligence if a child is found to have an elevated blood lead level.

I. Introduction

This chapter describes the procedure for maintaining housing in a lead-safe condition. Property owners and managers may use this procedure after completion of lead hazard controls, or, if applicable regulations permit, they may initiate a lead-safe maintenance program without completing any initial hazard controls. This chapter provides guidance to owners and managers of pre-1978 housing properties for guidance on how to maintain the housing in a lead-safe manner in accordance with the Environmental Protection Agency (EPA) Renovation, Repair, and Painting (RRP) Rule (40 CFR 745), and, for housing receiving HUD assistance, to properties covered by HUD's Lead Safe Housing Rule (24 CFR Part 35).

Owners and managers of properties that are covered by the HUD Lead-Safe Housing Rule should use this chapter as guidance on how to carry out the "ongoing lead-based paint maintenance" that is required by that regulation. The term "ongoing lead-safe maintenance," as used in this chapter, is intended to mean the same thing as the term "ongoing lead-based paint maintenance," as used in the HUD Lead-Safe Housing Rule. Pre-1978 properties that are required by the HUD Lead-Safe Housing Rule to incorporate ongoing lead-based paint maintenance into regular building operations include those receiving multi-family mortgage insurance, project-based assistance, rehabilitation assistance under the HOME program, tenant-based rental assistance (such as the Housing Choice Voucher Program), assistance under the Public Housing Program, and certain other types of assistance. This is not a complete list. Exemptions and exceptions may apply. Owners, managers or local program directors who are in doubt about HUD requirements should refer to the regulation at 24 CFR Part 35, contact their HUD field office, call the Lead Regulations Hotline at (202) 755-1785, extension 7698 (not a toll-free call), or e-mail HUD at: Lead.regulations@hud.gov. (Hearing- or speech-challenged individuals may access this number through TTY by calling the toll-free Federal Relay Service at 800-877-8339.)

Activities that are required by HUD or EPA are identified in this chapter as being "required" or as actions that "must" be done. Activities that are not required by HUD but are recommended by these *Guidelines* are identified as being "recommended" or as actions that "should" be done. Activities that may be done at the discretion of the owner or manager are identified as "optional."

Lead-safe maintenance is necessary because the potential exists for lead-based paint hazards to develop wherever lead-based paint is present. Previously intact lead-based paint can become deteriorated, lead hazard controls can fail, and maintenance or renovation can disturb leaded paint and generate lead in dust. The purposes of ongoing lead-safe maintenance are: (1) to assure that if potential lead hazards occur or reoccur, they will be spotted and controlled promptly before young children become exposed to lead; and (2) to assure that maintenance and renovation work that disturbs leaded paint will not cause lead exposure during the work and will not leave dwellings or the nearby environment contaminated with leaded-dust when the work is finished. If ongoing lead-safe maintenance is done with care, the probability of childhood lead exposure from lead-based paint hazards on the property is significantly reduced. Also, it is unlikely that a subsequent professional reevaluation, if required, will find any deteriorated paint or failed hazard control treatments, thereby substantially reducing the cost to the owner. (Reevaluation is described in section VII of Chapter 5.)

Ongoing lead-safe maintenance consists of:

- ◆ **Periodic visual assessments** to identify deteriorated paint, unusual amounts of visible dust, paint-related debris, failed lead hazard controls (if applicable), bare soil (if soil-lead hazard control is required or recommended), horizontal surfaces that are not easily cleanable (optional), chewable

surfaces with evidence of teeth marks (optional), and problems (structural and otherwise) that may be causing some of the foregoing conditions.

- ✦ **Correction of problems found in the visual assessments**, using lead-safe work practices for jobs that exceed a *de minimis* area (a minimal amount of paint disturbance, which is explained more fully in section II.C.3, below).
- ✦ **Using lead-safe work practices** when making all other paint-disturbing repairs and renovations exceeding the *de minimis* level.
- ✦ **Conducting a clearance examination** after any paint-disturbing work that exceeds the *de minimis* level.
- ✦ **In rental housing, asking residents to report to management** occurrences of deteriorated paint, chewing by young children on painted surfaces, failed lead hazard controls (if applicable), and bare soil (if applicable), so that owners can promptly correct situations that may be lead-based paint hazards.

Owners, managers, or maintenance staff can perform visual assessments and lead-safe work practices with only modest training. Lead-safe work practices are modifications to traditional maintenance and renovation methods. They are described in general terms in this chapter and in detail in other chapters of these *Guidelines*. Clearance examinations, however, must be done by a certified professional.

Ongoing lead-safe maintenance should be conducted in all dwelling units and common areas, unless the property is exempt, and the scope should include all exterior and interior surfaces where lead-based paint is known or presumed to be present. Also, lead-safe maintenance of ground cover is recommended if Government regulations affecting the property require that soil-lead hazards be identified and controlled, or if the owner or manager has information from a reliable source that soil-lead hazards have been found on the property. Otherwise, lead-safe maintenance of ground cover is optional in ongoing lead-safe maintenance.

These *Guidelines* recommend that lead-safe maintenance be practiced in all pre-1978 residential properties in which lead-based paint is known to be present or may be present. While lead-safe maintenance practices were designed initially for rental housing, the rationale and the basic procedure apply just as well to owner-occupied housing.

HUD regulations do not require ongoing lead-safe maintenance in residential properties found by a certified lead-based inspector to contain no lead-based paint, as defined by applicable Federal, State, Tribal or local regulations. Similarly, EPA regulations do not require lead-safe work practices in residential properties or child-occupied facilities found by such a lead-based inspection to be free of lead-based paint. The Federal standard for applied lead-based paint is paint or other surface coatings that contain lead equal to or exceeding 1.0 milligram per square centimeter or 0.5 percent by weight (the latter equivalent to 5,000 parts per million by weight). HUD and EPA regulations do not require lead-safe work practices if amounts of paint to be disturbed are below specific threshold amounts (see section II.C.3, below) or if the specific paint being disturbed is known not to be lead-based paint.

However, many pre-1978 painted surfaces that are classified as not being lead-based paint under Government standards may still contain *some* lead that can cause environmental contamination and human exposure if not handled correctly. Therefore, these *Guidelines* recommend the following work practices when disturbing any paint installed before 1978, regardless of whether it is or is not lead-based paint and regardless of whether the amount of paint to be disturbed is less than the applicable *de minimis* area:

- (1) *Never use the prohibited methods of paint removal that are described in this and other chapters of these Guidelines; and*
- (2) *When disturbing paint in housing occupied by children of less than 6 years of age, clean the work area thoroughly after finishing, preferably with a vacuum and wet cleaning, and keep residents out of the work area until after the clean-up.*

The rest of this chapter consists of three sections. Section II describes visual assessments in detail. Section III describes the lead-safe maintenance practices to be used in performing repairs, maintenance, or renovation. Section IV provides information on how to develop and manage an ongoing lead-safe maintenance program.

This chapter does not provide guidance on reevaluation. That subject is discussed in section VII of Chapter 5.

II. Visual Assessment

This section describes the scope, frequency, and methods to be used in visual assessments for lead-safe maintenance. Please note that this visual assessment is somewhat different than the visual assessments that are components of a risk assessment (described in Chapter 5) and a clearance examination (described in Chapter 15).

A. Frequency and Scope

The owner or owner's representative should perform, at least once a year, a visual assessment of each dwelling unit, each common area that is used by residents, exterior painted surfaces, and ground cover (if control of soil-lead hazards is required or recommended) (see Figure 6.1). Visual assessments should also be conducted when the owner or management receives complaints from residents about deteriorated paint or other potential lead hazards, when a dwelling turns over or becomes vacant, or when significant damage occurs that could affect the integrity of hazard control treatments (e.g., flooding, vandalism, fire).



FIGURE 6.1 Visual Assessment.

People performing a visual assessment should determine whether any of the following are present:

- ◆ **Deteriorated paint on surfaces** (both interior and exterior) that are known or presumed to be coated with lead-based paint; and the estimated size of area;
- ◆ **Visible settled dust** that clearly exceeds normal housekeeping standards;
- ◆ **Paint-related debris** (for example, paint chips or residue from paint stripping);
- ◆ **Failed lead-based paint hazard controls**, if any have been installed, particularly encapsulations and enclosures of paint surfaces, treatments of window friction surfaces, coverings of painted floors or stair treads, or coverings of bare soil;

- ◆ **Structural and other problems that may be causing paint deterioration or the failure of lead-based paint hazard controls**, such as water leaks and windows and doors with friction or impact surfaces; or
- ◆ **Bare soil** in outdoor play areas and other yard areas known to contain or presumed to contain lead in soil exceeding applicable standards, if soil-lead hazard control is required or recommended.

In addition, identification of the following items is optional:

- ◆ Horizontal surfaces that are not easily cleanable, and
- ◆ Chewable surfaces with evidence of teeth marks.

The findings of a visual assessment, including the exact location of any occurrences of the conditions listed above, should be recorded on Form 6.0 or a similar form. Corrective maintenance should be performed if any of these conditions are present.

B. Information on Known Hazards and Existing Hazard Controls

If testing of paint or soil and/or control or treatment of paint-lead or soil-lead hazards has been conducted in the areas to be visually assessed, the person performing the visual assessment should have the following information:

- ◆ The location of paint that is known to be lead-based paint and the location of paint that is known not to be lead-based paint. All other paint in pre-1978 housing should be presumed to be lead-based paint. According to Federal standards, lead-based paint is applied paint or other surface coatings that contain lead equal to or exceeding 1.0 milligram per square centimeter (mg/cm²) or more than 0.5 percent by weight or 5,000 parts per million (ppm). Standards issued by an EPA-authorized State, Tribal or local program may be different, and should be used if more stringent (i.e., lower). Information about the presence or absence of lead-based paint should be recorded on Form 6.0 or a similar form.
- ◆ The type and location of each control or treatment of a paint-lead hazard this is readily accessible to the visual assessor, except that (1) information on abatements that removed all lead-based paint is not necessary, and (2) information on paint stabilization is optional because failure of paint stabilization will be visually evident.
- ◆ The location of soil that is known to contain and not to contain soil-lead hazards and the type and location of each control or treatment of a soil-lead hazard, if control of soil-lead hazards is required or recommended. According to Federal standards, a soil-lead hazard is bare soil that contains total lead equal to or exceeding 400 ppm in a play area or an average of 1,200 ppm of bare soil in other parts of the yard. Standards issued by an EPA-authorized State, Tribal or local program may be different, and should be used if more stringent (i.e., lower).

Section IV.C.3, below, provides guidance on keeping inventories of known lead-based paint and controls and treatments that are in place.

C. Identifying Deteriorated Paint, Excessive Dust and Debris, and Failed Lead Hazard Controls

1. Training

It is not necessary to be a certified lead-based paint inspector, risk assessor or renovator to perform visual assessments for ongoing lead-safe maintenance, but people performing visual assessments must be trained to do so. While the inspector, risk assessor and renovator certification training courses include visual assessment training, for people who do not need to become certified in those disciplines, HUD recommends they take its module on visual assessment for deteriorated

paint available on the Internet at <http://www.hud.gov/offices/lead/training/> (see Figure 6.2). This course usually takes approximately one hour to complete. It is available as a self-paced, web-based training module. This module also includes the option to print a notice of course completion, which should be kept in the visual assessor's file.



FIGURE 6.2 Opening screen from HUD's first on-line visual assessment training curriculum. Updates may occur.

It is also recommended that owners and managers give those performing visual assessments a brief orientation or the information on: (1) the types of structural and other problems to look for that may be causing paint deterioration; (2) the types of lead-based paint hazard controls that have been used on the property, if any, and the signs of failure that should be identified; (3) what to look for with regard to bare soil, if control of soil-lead hazards is required or recommended; and (4) any optional considerations that the owner wants to identify in the assessment, such as surfaces that are not smooth and cleanable, and chewable surfaces with evidence of teeth marks.

2. Deteriorated Paint

Ongoing maintenance of painted surfaces is desirable for several reasons: (1) it helps prevent childhood lead poisoning; (2) it is cost-effective; and (3) it improves the condition and appearance of the property. Deterioration of lead-based paint is hazardous to young children because it may make it easier for a child to put contaminated paint in his or her mouth and because it may contribute to lead in house dust to which the child is exposed. Preventive maintenance can considerably extend the life of paint coatings, especially on the exterior.

Chapter 5 contains detailed information on how to visually identify deteriorated paint (see text at section II.D.3 of Chapter 5). All interior and exterior paint that is peeling, cracking, alligating, blistering, damaged, or separated from the substrate should be reported. Nail holes and hairline cracks are not considered to be deterioration.

If deteriorated paint is present, the person performing the visual assessment should describe its location on Form 6.0 or similar form, by room, building component, and specific location on the component. If it is known, as a result of previous paint testing, whether the paint is or is not lead-based paint, that information should also be entered on Form 6.0. It is recommended that there also be recorded on the form an estimate of the approximate area (in square feet) of each

occurrence of deteriorated paint. These area estimates will assist in planning maintenance work and will indicate whether the area of paint that will be disturbed is large enough that full lead-safe work practices must be used and a clearance examination must be conducted, as required in properties subject to the HUD Lead-Safe Housing Rule (see the following section on *de minimis* paint disturbance below). Finally, it is recommended that the visual assessor record any observed structural or other problems that may be causing paint deterioration (see section II.C.6, below).

Note that Forms 5.2 and 6.0 both cover visual assessments, the former for risk assessments, and the latter for visual assessments; intentionally, they are identical, which is why the forms have double titles.

3. Small Amounts of Paint

As described above, the area estimates in the visual assessments will determine how the repair or work is to be performed.

- ◆ HUD's Lead Safe Housing Rule states (24 CFR 35.1350(d)) that lead-safe work practices and clearance are not required in HUD-assisted "target housing"¹ if the total amount of paint disturbed by the work is no more than:
 - (1) 20 square feet on exterior surfaces,
 - (2) 2 square feet in any one interior room or space, or
 - (3) 10 percent of the total surface area on an interior or exterior component with a small surface area (such as window sills, baseboards, and trim).
- ◆ EPA's Renovation, Repair, and Painting (RRP) Rule does not cover minor repair and maintenance activities (40 CFR 745.83) in target housing or pre-1978 child-occupied facilities that disrupt no more than:
 - (1) 6 square feet or less of painted surface per room for interior activities, or
 - (2) 20 square feet or less of painted surface for exterior activities, and where none of the work practices prohibited or restricted by that rule (open-flame burning or torching of lead-based paint, using machines that remove lead-based paint through high-speed operation without HEPA exhaust control; and operating a heat gun on lead-based paint at or above 1100 degrees Fahrenheit) are used and where the work does not involve window replacement or demolition of painted surface areas.

These *Guidelines* recommend, however, that the following practices *always* be observed when disturbing paint in pre-1978 housing or child-occupied facilities, unless it is known that all layers of paint to be disturbed have been applied after 1977:

- (1) Never use the prohibited methods of paint removal that are described in section III.C.1, below; and
- (2) When disturbing paint *in housing occupied by children of less than 6 years of age, and child-occupied facilities*, always clean the work area thoroughly after finishing, preferably with a vacuum and wet cleaning, and keep occupants out of the work area

¹ Target housing is defined by Title X as meaning any housing constructed prior to 1978, except housing for the elderly or persons with disabilities (unless any child who is less than 6 years of age resides or is expected to reside in such housing) or any 0-bedroom dwelling. Most pre-1978 housing is target housing.

while work is underway and until after the clean-up and passing of clearance or cleaning verification, as applicable.

4. Visible Dust and Debris

The visual assessor should record on Form 6.0 or similar form, the location of any visible dust that exceeds normal housekeeping standards and any paint-related debris observed in dwelling units and common areas. If a dwelling unit is occupied, the residents should be notified that such dust or debris may be a hazard, and they should be urged to keep the dwelling clean. Form 6.0 provides a place to check whether residents are so notified. Of course, the owner should clean-up dust and debris in unoccupied dwelling units and common areas.

5. Failed Lead Hazard Controls

If any lead-based paint hazard controls are in place in the area being observed, the person performing the visual assessment should examine each such control, determine whether it is or is not still intact, and record the observation on Form 6.0 or similar form, including a brief written description of the problem. Although paint stabilization is a valid method of interim control of deteriorated lead-based paint, it is not necessary to make a special effort to examine all previous paint stabilizations, because the failure of paint stabilization will be caught by the identification of deteriorated paint.

6. Structural and Other Problems Causing Paint Deterioration and Hazard Control Failure

Chapter 11, section III.A, describes some of the problems that could cause premature paint failure or failure of lead-based paint hazard controls. People performing visual assessments should be familiar with this material and should briefly describe any such observed conditions on Form 6.0 or similar form. The most common cause of paint deterioration is moisture, which may derive from leaks in the roof, windows, walls, doors, or plumbing. The moisture may cause decay, rusting, or other deterioration of the building component that is painted, or it may affect just the paint. Other causes, in addition to moisture, include ultraviolet rays, extreme heat and cold, wind, and mechanical damage.

The visual assessor should also indicate on the form whether deteriorated paint results from friction or impact, because these conditions affect the method used to make a durable repair. A friction surface is a surface that is subject to abrasion or friction, such as certain window, floor, and stair surfaces (24 CFR 35.110, 40 CFR 745.63) may generate lead-contaminated dust if the paint is lead-based paint. The most common painted friction surfaces are on the channels in which the sashes of double-hung windows slide. Another common location is the edge or the head, jamb, or sill of doors that are poorly hung.

An impact surface is a surface that is subject to damage by repeated sudden force, such as certain parts of door frames (24 CFR 35.110, 40 CFR 745.63). Generally, the owner is responsible only for impact damage generated by a malfunctioning building component, such as a door knob banging against a wall. However, impact damage caused by residents should be taken into account when determining how to stabilize deteriorated paint on such surfaces.

D. Identifying Chewable Surfaces

Young children sometimes eat or mouth non-food articles. A chewable surface, such as a protruding interior window sill that is painted with lead-based paint, can be a dangerous hazard to them. Owners should ask visual assessors to look for potential chewable-surface hazards if a young child lives in the dwelling unit. To be a hazard, according to EPA regulations, a chewable surface must have evidence of teeth marks, but some States do not require bite marks for a surface to be considered a chewable-surface hazard.

These *Guidelines* recommend visual assessment of chewable surfaces only if a child under age 6 resides in the unit or the owner knows that a child under 6 is expected to reside there in the near future, and in pre-1978 child-occupied facilities. If a parent, guardian, or care giver is present at the time of the visual assessment, the assessor may ask whether a child has been observed chewing on painted surfaces, and, if so, which surfaces. Any identified surfaces should then be examined for evidence of teeth marks. If no parent or guardian is present, the visual assessor should examine interior window sills for teeth marks. Hard metal substrates and other materials that cannot be dented by the bite of a young child are not considered chewable.

E. Identifying Bare Soil

The visual assessment should also include an inspection of play areas and other yard areas to identify bare soil (see Figure 6.3) if one or more of the following conditions exists:

- ◆ Government regulations (Federal, State, Tribal or local) affecting the subject property require that bare soil be tested for lead and/or that known or presumed soil-lead hazards be controlled;
- ◆ The owner has actual knowledge, based on laboratory analysis of soil samples, that soil-lead hazards (as defined by Federal, State or Tribal regulations) have been found on the property and have not been abated; or
- ◆ The owner has actual knowledge, based on laboratory analysis of soil samples, that soil-lead hazards (as defined by Federal, State or Tribal regulations) have been found *consistently* on three or more other similar properties in the immediate neighborhood of the subject property (e.g., same block or block across the street), even though the owner does not have testing data showing that soil on the subject property does not contain soil-lead hazards.

Even if these conditions do not apply, an owner may wish, at his or her option, to take special precautions regarding ground cover if it is generally known that some soil in the neighborhood may be contaminated with lead and if young children reside in the property.

Bare soil means soil or sand not covered by grass, sod, other live ground covers, wood chips, gravel, artificial turf, or similar covering. (24 CFR 35.110) (see Figure 6.3)



FIGURE 6.3 An area of bare soil beneath a window with deteriorated paint.

A visual assessment for bare soil should include identification and reporting (on Form 6.1 or similar form) of any failures of earlier interim controls or abatements of soil-lead hazards as well as new areas of bare soil that have not been subject to hazard control. Information on failed hazard controls may be useful in selecting methods that will have a longer effective life.

The visual assessment for bare soil should distinguish between play areas and non-play areas. A play area is defined as an area of frequent soil contact by children of less than 6 years of age as indicated by, but not limited to, such factors as the presence of play equipment (e.g., sandboxes, swing sets, and sliding boards), toys, other children's possessions, observations of play patterns, or information provided by parents, residents, care givers, or property owners (24 CFR 35.110, 40 CFR 745.63). All play areas should be free of bare soil, unless it has been determined by a qualified professional (i.e., a certified risk assessor in most jurisdictions) that lead levels in the soil do not exceed applicable standards.

In non-play areas, however, bare soil totaling no more than 9 square feet (or 0.8 square meters) per property may be considered *de minimis*; that is, less than 9 square feet of bare soil with levels of lead exceeding applicable standards is not likely to constitute a hazard. The EPA and some States do not recognize this bare-soil *de minimis* level. "However, EPA highly recommends using the HUD *Guidelines* for risk assessment. This would avoid declaring very small amounts of soil to be a hazard in the non-play areas of the yard. This would also help target resources by eliminating the need to evaluate soil or respond to contamination or hazards for properties where there is only a small amount of bare soil." (EPA, 2001)

Therefore persons conducting visual assessments for bare soil should make a rough calculation of the approximate area of bare soil in non-play areas and record that figure for use in determining whether additional soil coverings are necessary.

Visual assessors should always examine the bare soil within three feet of building walls (dripline). Research has found that soil in this area tends to have a higher concentration of lead than in other parts of the yard (NCHH, 2004).

F. Identifying Horizontal Surfaces that Are Not Smooth and Cleanable (Optional)

In homes with dust-lead hazards, it is often difficult to adequately clean rough or pitted surfaces that are accessible to children so that they are free of dust hazards and so the surfaces will achieve clearance after cleaning by licensed contractors or workers trained in the use of lead-safe work practices. Contaminated dust lodges in cracks and crevices in floors, interior window sills, or window troughs, and then is picked up in wipe samples that are analyzed by laboratories.

Therefore owners may want to prevent this problem by asking people performing visual assessments to identify surfaces that are likely to be difficult to clean, so that they can be repaired or coated with a sealant. Alternatively, owners can wait and see if there is a clearance failure and, if so, then repair the surface so that it is smooth and cleanable.

III. Ongoing Lead-Safe Maintenance Practices

This section describes methods of performing maintenance jobs in a lead-safe manner.

A. Introduction

With traditional building maintenance practices, disturbance of surfaces with lead-based paint can turn a potential problem into an immediate hazard. However, if maintenance practices are modified to provide sufficient lead-based paint protection to residents, workers, and the environment, lead hazards associated with maintenance and renovation work can be controlled.

To illustrate the importance of protective measures, even for small-scale jobs, consider how much lead is contained within a 1 square foot area that is painted with lead-based paint at the Federal regulatory definition of 1 mg/cm². To do this, convert centimeters (cm) to inches, and then inches to feet (ft), and then milligrams (mg) to micrograms (µg):

$$1 \text{ mg/cm}^2 * (2.54 \text{ cm/inch})^2 * (12 \text{ inches/ft})^2 * 1,000 \text{ µg/mg} = 929,000 \text{ µg/ft}^2$$

The 1 ft² painted area with lead-based paint at the Federal regulatory definition of 1 mg/cm², will have 929,000 µg of lead (almost a gram of lead). In the extreme case of all of this lead being turned into dust (as might happen with machine sanding) and none of the dust being collected by a filter, but being distributed evenly over the floor in a room measuring 10 feet x 10 feet (100 square feet, or 100 ft²), then there would be:

$$929,000 \text{ µg/ft}^2 / 100 \text{ ft}^2 = 9,290 \text{ µg/ft}^2$$

of lead on the floor. This number is compared to the EPA floor-dust lead hazard standard and floor clearance standard of 40 µg/ft². (Another way of looking at this is that the lead from just a ½ inch circle of paint that meets the lead-based paint definition would, if spread evenly over the 10 foot x 10 foot room would create lead dust at the dust-lead hazard threshold throughout the room.) Therefore, a significant amount of leaded dust can be released from even a small painted area. Even though most maintenance jobs would not turn *all* the lead-based paint into leaded-dust, it should be clear that large amounts of lead-contaminated dust can be generated from even low concentrations of lead-based paint or conversion of even small fractions of the paint into dust.

Lead-safe work practices and thorough clean-up are essential even for small-scale jobs. That is why these *Guidelines* recommend them even for jobs for which HUD and EPA regulations do not require them. Workers should never use the prohibited paint-removal practices described in Section III.C.1, below. In addition, when working in dwelling units or common areas frequented by children under age 6, workers should keep residents and pets out of the work area and should thoroughly clean the work area before letting them enter.

B. Ways in Which Maintenance Work Can Create or Intensify Lead Hazards

1. Paint Abrasion or Other Disturbance

The most common problem with traditional maintenance practices is that lead dust may be created when paint is disturbed. Common activities, such as sanding, scraping, sawing, hammering, or grinding on surfaces coated with lead-based paint can create large amounts of lead-contaminated dust, which may be hazardous for both workers and residents, especially

young children. Torch cutting or welding on painted metal surfaces is especially dangerous to workers and is prohibited under OSHA regulations (the paint must be removed before torch cutting or welding). Although most individual maintenance jobs do not last very long, it is possible to cause a significant exposure for the worker and create hazards for occupants. For example, power sanding on surfaces with lead-based paint has been found to cause worker exposures as high as 11,000 $\mu\text{g}/\text{m}^3$ (Lange, 2000), which is well above the OSHA permissible exposure limit (PEL) of 50 $\mu\text{g}/\text{m}^3$. Worker exposures associated with manual sanding, along with manual scraping, without control measures may also exceed the OSHA PEL, and may exceed 500 $\mu\text{g}/\text{m}^3$ (Zhu, 2012), OSHA's assumed highest concentration generated by manual sanding (29 CFR 1926.62(d)(2)(i)(A)) and the maximum concentration for which half-faced HEPA-filtered air purifying respirator may be used. Other typical tasks, such as carpet removal, have also been shown to result in worker exposures well above the OSHA PEL, depending on how long the exposures last (NIOSH, 1990; EPA, 1997b; EPA, 1999a). Exposures can be kept well below the limit if the work is carefully conducted (NIOSH, 1990).

2. Water Damage

Water damage can occur from sudden circumstances, such as bursting pipes, overflowing tubs and sinks, broken fixtures, or storm damage. Water damage can also occur from less obvious problems, such as condensation, slow leaks in pipes or fixtures, roof failure, improper building drainage around the perimeter of the building, or accidental resident misuse (e.g., leaving the windows open during a rain storm). All of these situations can lead to paint failure, either by deterioration of the paint itself, or deterioration of the painted substrate. If only the source of the water leak is repaired, as in an emergency situation, the paint deterioration may not be evident until several weeks following the water leak repair and it may be left to the resident to repaint. If lead-based paint is known or presumed to be present, however, the paint should also be repaired as quickly as possible, after the surface has dried and the substrate has been repaired, using lead-safe work practices as stated in Section C.1.

3. Dust Exposures

Many types of maintenance work can release substantial quantities of dust into the residence. Examples include preparing surfaces for repainting, floor sanding, window repair (window troughs often contain very high levels of leaded dust), and plastering. Traditional maintenance practices employ the use of drop cloths and cardboard or newspapers to protect furniture, eating surfaces, and walkways. If the drop cloths become full of leaded dust and are used again, they may contaminate the next worksite. Poorly-controlled dust during maintenance work has accounted for numerous cases of childhood lead-poisoning (Farfel and Chisolm, 1990; Amitai, 1991; Rabinowitz, 1985a; Shannon, 1992; EPA, 1999b).

Lead-contaminated dust exposures to workers and residents can be controlled by the following:

- ◆ **Using wet methods** when sanding, scraping, or sweeping.
- ◆ **Covering floors and furnishings** with disposable and impermeable protective sheeting such as polyethylene.

- ✦ **Using foot coverings**, dedicated footwear and walk-off mats to minimize tracking leaded-dust out of the work area.
- ✦ **Sealing rooms** to avoid contamination of adjacent areas.
- ✦ **Using approved respirators.**

4. Grounds Keeping

If the soil is contaminated, certain grounds keeping activities can pose a risk to workers and occupants. Excavation to lay new pipes, regrading, and sodding disturbs the soil. Bare soil can be more easily tracked or blown into dwellings where it becomes part of the house dust and where a child can become exposed to it. If the soil is known or presumed to contain high concentrations of lead, simple protective measures can be introduced to control the spread of dust from ground keeping activities. Keeping the soil wet is usually effective, if proper erosion control measures are established. Disposable shoe coverings or dedicated work shoes will, if used properly, prevent tracking contaminated soil into dwellings, workers' automobiles, and maintenance shops.

C. Elements of an Ongoing Lead-Safe Maintenance Program

The basic elements of ongoing lead-safe maintenance are as follows:

1. Incorporate Lead-Safe Work Practices in All Paint-Disturbing Work

"Lead-safe work practices" are ways to perform paint-disturbing work (repairs, maintenance, rehabilitation, renovation, or remodeling) so that occupants and workers are protected from exposure to lead in dust and debris generated by the work and so that the environment is not contaminated. Owners should incorporate lead-safe work practices into all maintenance, renovation, or repair work that disturbs paint, and require that they be conducted by appropriately trained and, as applicable, certified workers. Lead-safe work practices include the following:

- ✦ **Work with adequate amounts of water.** Keep the surface wet with a water mist, except near electrical outlets and fixtures, so sanding, scraping, planing, etc. generate less dust and the dust that is created is controlled.
- ✦ **Protect occupants and prepare the worksite.** The worksite should be delineated and set up before work begins. Occupants should be protected. Guidance on worksite set-up and occupant protection is provided in Chapter 8. This guidance varies with the amount of dust likely to be generated by the work.
 - Generally, occupants should not be allowed in the work area until after the work is finished and the area is cleaned and cleared. Temporary relocation may be necessary. Personal belongings should be moved from the area when possible, or cleaned, covered and sealed. Floors of the work area (and, for high-dust jobs, passageways used by workers) should be protected with disposable, impermeable protective sheeting (such as heavy-duty polyethylene). Workers should not track dust from the work area to the rest of the dwelling.

- For high-dust jobs, dust should be contained within the room or rooms in which work is conducted by installing protective sheeting over doors and temporarily turning off the HVAC system for the work area and covering HVAC vents.
- ◆ **Specialized cleaning.** For jobs lasting more than a day, daily clean-up is recommended. When the work is completed, the worksite should be thoroughly cleaned, preferably with a HEPA vacuum and wet wash, to assure that the site is free of dust-lead hazards and can achieve clearance. Guidance on cleaning is provided in Chapter 14. Generally, final clean-up includes cleaning and removal of protective sheeting, and vacuuming and wet washing all horizontal surfaces in the work area, adjoining spaces and passageways used by workers, including floors, interior window sills, and window troughs. The area to be cleaned depends on the amount of dust generated by the job.
- ◆ **Do not use the following paint removal practices except as specified.** Workers should *not* use the following paint removal methods in HUD-assisted housing; the methods numbered 6 and 7 are permitted in unassisted housing:
 1. **Open-flame burning or torching.** This can produce toxic gases that a HEPA filter cartridge on a respirator cannot trap (a second, organic, filter is necessary). This method can create high levels of toxic dust that are extremely difficult to clean up; and it can burn down a house.
 2. **Operating a heat gun at surface temperatures at or above 1100 degrees Fahrenheit.** Operating heat guns at such high temperatures can release lead dust and fumes and induce large increases in the blood lead levels of young children (Farfel and Chisolm, 1990; also cited by EPA in the preamble to its final rule on Requirements for Lead-Based Paint Activities in Target Housing and Child-Occupied Facilities. 61 FR 45777, August 29, 1996, at 45795.)
 3. **Machine sanding or grinding without a HEPA local exhaust control and a shroud.** Machine sanding or grinding with both a HEPA local exhaust control attached to the tool, and a shroud that meets the following performance requirement is permissible. The shroud must surround the surface being contacted by the tool with a barrier that prevents dust from flying out around the perimeter of the machine, *and* attached to a HEPA vacuum. However, this work method should be conducted used only by workers trained in its use. Because some dust may still blow out around the perimeter of the machine, workers near the machine should wear half-face respirators (with N100 cartridge) at a minimum. Also, the work area should be completely isolated if the machine is used inside.
 4. **Abrasive blasting or sandblasting without HEPA local exhaust control.** These methods should be used only within an enclosure that contains the spread of dust, chips, and debris, and that has a HEPA exhaust. This work method should be conducted used only by workers trained in its use.
 5. **Uncontained hydroblasting.** Removal of paint using this method can spread paint chips, dust, and debris beyond the work area containment. Contained pressure washing at less than 5,000 pounds per square inch (PSI) can be done within a protective enclosure to prevent the spread of paint chips, dust, and debris. Water run-off should also be contained. Because this method requires precautions that

are beyond the scope of most courses in lead-safe work practices, it should only be used by certified lead abatement workers under the supervision of a certified abatement supervisor.

6. **Manual dry sanding or dry scraping**, except that dry scraping is acceptable in conjunction with heat guns with surface temperature of less than 1100°F, or within one foot of electrical outlets, or when treating defective paint spots totaling no more than 2 square feet in any one interior room or 20 square feet on exterior surfaces.
7. **Paint stripping in a poorly ventilated space when using a volatile stripper that is a hazardous substance** in accordance with regulations of the Consumer Product Safety Commission (CPSC) at 16 CFR 1500.3(b)(4) and/or a hazardous chemical in accordance with the OSHA regulations at 29 CFR 1910.1059 (Methylene Chloride), as applicable to the work. (This practice is prohibited by HUD (24 CFR 35.140(f)) regarding work on HUD-assisted housing, but is not explicitly prohibited by EPA regulations.) OSHA's Respiratory Protection regulation (29 CFR 1910.134) may also apply when working in a space without adequate ventilation, as could the other OSHA personal protective equipment standards.

Paint strippers with methylene chloride should be avoided. OSHA has found that adults exposed to methylene chloride "are at increased risk of developing cancer, adverse effects on the heart, central nervous system and liver, and skin or eye irritation. Exposure may occur through inhalation, by absorption through the skin, or through contact with the skin." ("Occupational Exposure to Methylene Chloride; Final Rule," 62 *FR* 1493, January 10, 1997). It is especially important that people who use paint strippers frequently not use them in a poorly ventilated area. CPSC and EPA recommend that people who strip paint provide ventilation by opening all doors and windows and making sure there is fresh air movement throughout the room ("What You Should Know About Using Paint Strippers," CPSC Document #423, and EPA Document EPA 747-F-95-002) (www.cpsc.gov/cpsc/pub/pubs/423.html). OSHA's permissible exposure limit for methylene chloride in air was reduced in 1997 from 500 to 25 parts per million (29 CFR 1910.1052 for general industry, and the identical 29 CFR 1926.1152 for construction). Methylene chloride cannot be detected by odor at the permissible exposure limit, and negative-pressure respirators with organic vapor cartridges are generally ineffective for personal protection against it. OSHA's regulation for Methylene Chloride, 29 CFR 1910.1052(g) covers respiratory protection.

- ✦ Alternative paint strippers may be safer but have their own safety and/or health concerns, so all paint strippers must be used carefully. Always follow precautions provided by the manufacturer. Waste and debris from the job should be wrapped or bagged, and sealed and properly disposed of as described in Chapter 10.

Lead-safe work practices are not required by EPA and HUD regulations if: (1) the paint being disturbed is not lead-based paint according to the Federal regulations; and (2) the total amount of paint disturbed by the work is no more than the applicable very small amount (the *de minimis* amounts, or the minor repair and maintenance activities amounts, described in section II.C.3, for work covered by the HUD Lead Safe Housing Rule or the EPA RRP Rule, respectively). However, as explained above and in sections II.C.3 and III.A, these *Guidelines* recommend certain minimal safe work practices even if Federal regulations do not require them.

2. Stabilize Deteriorated Paint

Owners should stabilize all deteriorated paint that is known or presumed to be lead-based, or address the problem otherwise, such as through component replacement, or abatement of the deteriorated paint. Paint stabilization includes repair of conditions that may be contributing to the paint deterioration (such as deterioration of or damage to the building component, or malfunctioning doors and windows causing friction or impact) as well as surface preparation, and repainting. Stabilization may also involve repair of any exterior and interior water leaks that are causing paint deterioration and repair or replacement of rotted components, defective plaster, loose wallpaper, and missing door hardware needed to eliminate impact damage. Prepare the surface using wet methods. When removing paint, do not use prohibited practices listed in section III.C.1, above. Clean and, if necessary, degloss surfaces before repainting. Select and apply primer and topcoat according to the manufacturer's instructions. Clean-up the area thoroughly after the work. Detailed guidance on methods of paint stabilization is provided in section III of Chapter 11. Section IV of Chapter 11 provides guidance on treatment of friction, impact, and chewable surfaces.

3. Repair Failed Lead Hazard Controls

Owners should repair or replace any previous lead-based paint hazard control treatments that are no longer performing as designed. Encapsulations may become loose from the substrate. Wall paneling or siding may be damaged and no longer completely enclose a surface with lead-based paint. Coverings of lead-based paint on floors and stairs may become worn or loose. Ground covers may die, erode, or become worn, loose or damaged, exposing bare soil that is known to be a hazard. Guidance on encapsulation is provided in Chapter 13, specifically recommending a patch test to confirm that an encapsulant is compatible with a particular substrate. Methods of enclosing lead-based paint are explained in Chapter 12 (for abatement methods such as installing wallboard or paneling or exterior siding) and Chapter 11 (for interim control methods such as installing aluminum coil stock, or covering floors and stair treads). Chapter 11 also provides guidance on interim treatments of window friction surfaces, and coverings of bare soil. Note that failure of a lead hazard control may indicate that a different treatment should be used. See section I.A of Chapter 11 for a discussion of conditions in which some interim controls are likely to be ineffective.

4. Clean-up Dust and Debris

Upon completion of a paint-disturbing maintenance, repair, or renovation job, workers should thoroughly clean the work area, adjoining spaces, and any passageways used to access the work area. The area to be cleaned depends whether the job is considered high- or low-dust. See Chapters 8 and 14.

On a continuing basis, dwelling units and common areas should be kept free of obvious accumulations of dust and paint-related debris that exceed normal housekeeping standards. In rental properties, the owner should call potentially hazardous dust and debris to the attention of the tenant if cleaning is the resident's responsibility. All units should be cleaned at turnover, and window troughs should be cleaned at that time.

5. Control Chewable Surfaces

In spaces frequented by children under age 6, chewable surfaces with evidence of teeth marks should be covered with a puncture-resistant material, or the paint should be removed and the surface repainted. Two options for covering are aluminum coil stock or a hard, puncture-resistant encapsulant. Section IV of Chapter 11 provides guidance on covering chewable surfaces. Paint removal methods are discussed in Chapter 12.

6. Make Surfaces Smooth and Cleanable (Optional)

Horizontal surfaces (such as floors, stair treads, interior window sills, and window troughs) that are rough, cracked, pitted or porous should be made smooth and easily cleanable by covering or coating them with an appropriate material such as metal coil stock, polyurethane, sheet vinyl, or linoleum.

7. Inform Residents About Lead-Based Paint Hazards and Request Their Cooperation

Owners should inform residents about lead-based paint hazards so they will comply with occupant protection measures, such as staying out of work areas, respecting dust-containment installations, informing the landlord of deteriorated paint, keeping their units clean, and avoiding excessively long hot showers in inadequately ventilated bathrooms. The EPA's Pre-Renovation Education (PRE) rule, as amended by the EPA's Renovation, Repair, and Painting (RRP) Rule, requires persons performing, for compensation, any kind of renovation activity that is more than the minor repair and maintenance activities threshold described in Section II.C.3, above to provide a lead-information pamphlet to owners and residents prior to beginning work (40 CFR Part 745, subpart E). Detailed information on this informational requirement can be found at <http://www.epa.gov/lead/pubs/leadrenf.htm>.

In housing receiving HUD assistance that is covered by the Lead Safe Housing Rule, the occupants must be notified within 15 days of the results of a lead evaluation or the presumption that lead-based paint or lead-based paint hazards are present, and within 15 days of results of lead hazard control activities (including clearance examination results and where any lead-based paint remains in the work areas) after the work is completed.

8. Perform Clearance Examinations to Check Dust-Lead Levels

HUD recommends that clearance examinations be performed after completion of maintenance and renovation work and associated clean-up when work exceeds the *de minimis* level, and requires this for housing receiving Federal assistance. EPA requires clearance after abatement projects, but not after other work. A clearance examination consists of a visual assessment for deteriorated paint, dust and debris; taking samples of dust on horizontal surfaces (floors, interior window sills, and window troughs); and testing the samples for lead. Clearance examiners should wait a minimum of one hour after the final clean-up of the work before collecting wipe samples of dust. Testing should be done by a laboratory recognized by EPA for analysis of lead in wipe samples. Workers and supervisors should not know where the wipe samples will be taken. Clearance should be performed by a person certified to perform clearance examinations in the State or Tribal area (usually a risk assessor, a lead-based paint inspector, or a sampling

technician). Clearance procedures are described in Chapter 15 and/or ASTM 2271, "Standard Practice for Clearance Examinations Following Lead Hazard Reduction Activities in Single-Family Dwellings and Child-Occupied Facilities." (www.astm.org/Standard/index.shtml)

HUD does not require clearance in housing receiving Federal assistance if the area of paint disturbed by the work is no more than HUD's *de minimis* level defined at section II.C.3. For housing not covered by HUD's Lead Safe Housing Rule, these *Guidelines* recommend that, as a quality control check on their training and the project supervision, clearance examinations, including dust sampling, be conducted after maintenance jobs exceeding the *de minimis* level if the work is performed by newly trained workers, until three consecutive clearances of their jobs are passed on initial examination (i.e., on the first try), even if clearance is not required by regulation. Project supervisors (whether they are certified renovators or abatement supervisors) should always conduct a visual assessment of the work area, adjacent rooms, and passageways used by workers to determine that the clean-up, as well as the maintenance work, has been done properly; this visual assessment is required by HUD for work exceeding its *de minimis* level, and by EPA for renovation, repair, or painting work exceeding its minor repair and maintenance activities level (section II.C.3, and 40 CFR 745.83) and for all abatement work (Chapter 12, and 40 CFR 745.227(e)(8)(i)).

9. Addressing Bare Soil and Sandboxes

If the conditions described above in section II.E apply, all bare soil should be covered (see Figure 6.4). See section VI of Chapter 11 for guidance on soil-hazard controls.

If there is a sandbox containing sand that has not been tested for lead, the owner should:

- ◆ Test the sand and, if it is a hazard, replace it with sand with lead content of less than 200 µg/g if possible (this is best practice) but certainly less than 400 µg/g, which is the EPA requirement;
- ◆ Omit testing and replace the sand with new sand with the same lead content as in option (a); or
- ◆ Remove the sandbox and the sand.

D. Qualifications of Firms, Workers, and Clearance Examiners

Workers performing lead-safe maintenance and lead-safe renovation must be supervised by a certified renovator working for a certified renovation firm if the amount of paint being disturbed is above the EPA's minor repair and maintenance activities threshold. If the housing is receiving federal housing assistance, the workers need to be certified renovators

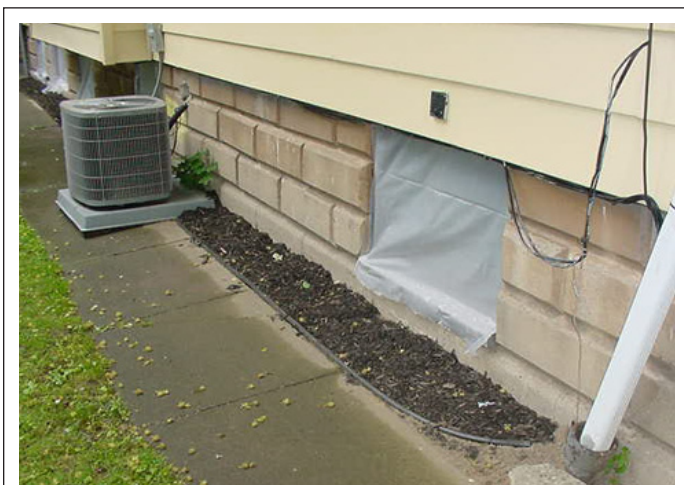


FIGURE 6.4 Bare soil in Figure 6.3 covered with mulch (the window was sealed during the process of controlling the bare soil).

themselves, and be supervised by a certified renovator working for a certified renovation firm if the amount of paint being disturbed is above HUD's *de minimis* threshold. See section IV.C.2, below, for information on training courses.)

Note that an owner of rental property working on a rental unit must establish a renovation firm that is certified by the EPA or the State, as applicable. Only an owner working on the housing unit in which only she and, if applicable, her family, but no other tenants, live is exempt from this firm certification requirement. (See Section II.C.3, above, about the thresholds.)

Persons performing clearance examinations must be certified by EPA or an EPA-authorized State, Tribe, or Territory (as applicable) as a risk assessor, a lead-based paint inspector, or a sampling technician, as allowed.

IV. Managing Ongoing Lead-Safe Maintenance

This section describes how an ongoing lead-safe maintenance program can be developed and managed. For multi-family housing, the lead-safe maintenance program should be included in the Lead Hazard Control Plan discussed in Chapter 11 (see Section II.A of that chapter).

A. Determining the Scope of the Program

At the outset, the owner should determine in writing exactly what the scope of the program is for the property in question. Some objectives are common to all properties, but there are several variations and options that are determined by Governmental regulation and the choice of the owner.

All lead-safe maintenance programs should include periodic visual assessments to identify deteriorated paint, paint-related debris, and excessive visible dust. All programs should also take steps to correct identified problems to the extent that they are the responsibility of the owner, and should use lead-safe work practices in doing so. All programs should also use lead-safe work practices when making any other paint-disturbing repairs and renovations. Clearance examinations should be included as required or otherwise appropriate. Finally, all programs should include communications with residents about lead-based paint hazards, including complying with the EPA Pre-Renovation Education Rule, and seeking residents' cooperation in cleaning their units frequently to keep dust accumulation to a minimum and reporting occurrences of paint deterioration, failed lead hazard controls (if applicable), and bare soil (if applicable) so that owners can promptly correct situations that are or may be lead-based paint hazards.

It should also be remembered that the HUD-EPA Lead Disclosure Rule must be observed. Owners of pre-1978 rental properties that are covered by that Rule must, among other requirements discussed in Appendix 6, provide the lead warning statement, and the EPA-approved pamphlet, and must disclose any actual knowledge, records and reports of lead-based paint and lead-based paint hazards to prospective tenants. Current tenants must be told of any new knowledge, records and reports at the time of lease renewal when lease conditions change. Disclosure to buyers prior to sale is also required; in addition to the requirements for rentals, sellers must provide an opportunity (typically 10 days) for the prospective buyer to conduct a lead-based paint inspection and/or risk assessment, and provide the buyer with the reports and records of lead-based paint and lead-based paint hazards.

Beyond these basic elements are a number of questions that owners or managers should answer in preparing to determine the scope and nature of their ongoing lead-safe maintenance program:

1. *Have lead-based paint hazards been identified through a risk assessment and, if so, have the hazards been controlled?* If hazards been identified but not yet controlled, they should be controlled promptly. If hazards have been controlled, the controls should be inspected during visual assessments and repaired if found to be failing.
2. *Do laws or regulations require that soil-lead hazards be controlled?* If so, visual assessments should include inspection of the grounds to identify bare soil, and bare soil should be covered according to guidance in this chapter and either Chapter 11 or 12. (If soil-lead hazard controls are in place, they should be identified in the answer to question 1, above.)
3. *Do laws or regulations require that floors, interior window sills, window troughs, or other horizontal surfaces be kept smooth and cleanable?* If yes, the condition of these surfaces should be visually assessed periodically and corrected if found to be rough and difficult to clean. If no, the owner may disregard the question of smooth and cleanable surfaces, or the owner may choose to maintain these surfaces in a smooth and cleanable condition.
4. *Do laws or regulations require that chewable surfaces be controlled?* If yes, the condition of these surfaces should be visually assessed periodically and corrected. If no, the owner may disregard the question of chewable surfaces, or the owner may choose to remove any lead-based paint from them.
5. *Do laws or regulations require that a clearance examination, including dust testing, be conducted after all paint-disturbing work, or that disturb more than a de minimis amount of paint?* If yes, a clearance examination must always be conducted. If no, clearance examinations should be conducted at the frequencies stated in section III.C.8, above.
6. *Do laws or regulations require that current residents be informed of the results of the clearance examination?* If yes, residents should be informed as soon as feasible, and within the required period. For example, for federally-assisted target housing, HUD requires tenant notification of hazard reduction activity within 15 days; see section III.C.7, above. If no, release of such information is at the option of the owner. For renovation, repair, or painting work in target housing that exceeds the EPA's minor repair and maintenance activities threshold, the renovation firm must, provide specific information about the test kit sampling or clearance examination within 30 days to the person who contracted for the renovation; EPA does not require notification of residents. Note, also, that new information on lead-based paint and lead-based paint hazards, such as clearance examination results, must be provided to current residents at the time of lease renewal under the HUD-EPA Lead Disclosure Rule (which applies to almost all pre-1978 housing).
7. *Do laws or regulations require only that ongoing lead-safe maintenance be carried out in dwelling units occupied by children under age 6, and common and exterior areas associated with those dwelling units?* If yes, lead-safe maintenance in other units is optional. This situation arises, for example, with:
 - ◆ HUD-assisted tenant-based rental assistance (under the housing choice voucher program), for which the Lead Safe Housing Rule applies only to dwelling units in target housing occupied or to be occupied by families or households that have one or more children of less than 6 years of age, common areas servicing such dwelling units, and exterior painted surfaces associated with such dwelling units or common areas. Common areas servicing a dwelling unit include those areas through which residents pass to gain access to the unit and other areas frequented by resident children of less than 6 years of age, including on-site play areas and child care facilities. (24 CFR 35.1200(b)(1))

- ◆ Some State and local jurisdictions require ongoing lead-safe maintenance in certain housing. For example, an owner of housing in Massachusetts who obtains a Letter of Interim Control must implement an ongoing lead-safe maintenance program (105 Code of Massachusetts Regulations 460.105(E), Maintenance and Monitoring). In New York City, rental housing “[o]wners must prevent the reasonably foreseeable occurrence of lead hazards and remediate them, and the underlying defects that may cause lead hazards, using safe work practices in apartments [and] in common areas.” (Local Law 1 of 2004 – A Summary. Department of Housing Preservation and Development. City of New York. See also title 28 Rules of the City of New York § 11-02, Owner’s Responsibility to Remediate, and § 11-04, Investigation for Lead-based Paint Hazards, ¶ (a).)

8. *Is lead-based paint known to be present?*

The property owner or manager must presume that all paint is lead-based paint, and that all deteriorated paint is a lead-based paint hazard until:

- ◆ an inspection is conducted, or
- ◆ chemical spot test kit testing determines that lead-based paint is absent on building components to be worked on under the RRP Rule.

If an inspection was conducted and no lead-based paint was found, the property is exempt from federal lead-based paint regulations, and lead-safe maintenance is not necessary, although the precautions recommended at the conclusion of section I of this chapter, and in section II.C.3, should be observed.

If an inspection was conducted and lead-based paint was found, has it been removed?

- ◆ If the lead-based paint has been removed, the property may be exempt from the federal lead-based paint regulations. See Appendix 6 for regulatory requirements before the property can be considered to be exempt.
- ◆ If the paint has not been removed, lead-safe maintenance procedures need to continue, focused on the remaining surfaces with known or presumed lead-based paint. (See Chapter 7 for how to extend the knowledge of lead-based paint status from surfaces that were sampled to surfaces that were not sampled).

B. Assignment of Responsibilities

Owners or managers should assign each of the following ongoing lead-safe maintenance responsibilities to a specific individual and should describe the responsibilities in writing. Based on the size of the organization responsible for maintaining the property (including staff and, possibly, maintenance supervision contractors), and the skill, knowledge, training and experience of the personnel involved, an individual may have one or more than one area of responsibility.

- ◆ **Managing visual assessments**, which includes assuring that visual assessments are performed at all units, areas, and surfaces at the recommended frequency; determining what items should be looked for in visual assessments; ensuring that persons performing visual assessments are trained in identifying deteriorated paint and other items to be observed, and that they know how to record on Form 6.0 or similar form all observations made during the visual assessments.
- ◆ **Ensuring that workers performing paint-disturbing work are working safely and in a lead-safe manner.** This includes ensuring that workers are following OSHA requirements (or the State

occupational safety and health requirements, if applicable) and are using lead-safe work practices in which they have been trained by becoming certified renovators or, in HUD-assisted housing, becoming certified lead-based paint abatement workers or supervisors, or being supervised by a certified lead-based paint abatement supervisor; or, in unassisted housing, being supervised by a certified renovator who has provided them with project-specific on-the-job training in lead-safe work practices. Employers are responsible for instituting engineering and work practice controls including administrative controls to the extent feasible to reduce employee exposure to lead. If those controls are feasible but not adequate to reduce exposures below OSHA's permissible exposure limit for lead, they must be supplemented with (not replaced by) appropriate respiratory protection. (See OSHA's lead in construction standard, 29 CFR 1926.62, OSHA's summary of the standard at its appendix B; and Chapter 9 and Appendix 6 of these *Guidelines*.)

- ◆ **Maintaining records** on the existence of lead-based paint and lead hazard controls, and on the performance of lead-safe maintenance, including visual assessment records and records of completion of maintenance and renovation work and clearance examinations. If the work is done by employees of the owner or manager, maintaining records in accordance with the OSHA lead in construction standard (29 CFR 1926.62(n)). (See Chapter 9 and Appendix 6 of these *Guidelines*.)
- ◆ **Determining exactly what lead-safe work practices should be used on each paint-disturbing job**, which includes determining whether the specific job will disturb paint that is known or presumed to be lead-based, whether the job will be a low-dust or high-dust job, and what occupant protection and worksite preparation methods are appropriate to the job. (See chapters 8 and 11 of these *Guidelines*.)
- ◆ **Modifying the work order system** to include necessary information for the maintenance workers on lead-safe work practices for each job.
- ◆ **Handling communications with residents**, including compliance with the EPA Pre-Renovation Education rule (PRE), and HUD's Lead Safe Housing Rule, and notifying residents of the results of environmental testing before work is begun (if any), the results of lead hazard controls (if any), and the results of clearance dust testing and cleaning verification.



FIGURE 6.5 Unit turnover is an excellent time to conduct the visual assessment and perform lead-safe maintenance activities.

- ◆ **Purchasing and maintaining supplies and equipment**, including lead information pamphlets, respirators, protective sheeting, workplace barrier tape, high-quality vacuums (preferably HEPA), disposable shoe coverings, protective clothing, and cleaning equipment.
- ◆ **Monitoring the work and managing clearance**, including inspecting ongoing work for lead-safe work practices, inspecting jobs after clean-up, and arranging for clearance examinations.

For small staffs, a single person may handle all of these tasks; for larger staffs, coordination is essential. If there is only a single maintenance person and owner/supervisor, a written program may not be essential, but it is quite useful as a reminder of what needs to be done (see Figure 6.5).

C. Description of Responsibilities

1. Managing Visual Assessments

The main objectives of managing visual assessments are to assure that visual assessments are performed at all dwelling units, common areas, exterior painted surfaces and grounds (if required or recommended) at the frequency described in section II.A, above, and that persons performing visual assessments know what to look for in a given area and how to record their observations.

It is suggested that a list be made of all spaces (i.e., dwelling units, common areas, exterior surfaces) to which visual assessment for lead-safe maintenance applies at the subject property, and that the date of each visual assessment of each space on the list be recorded, including those made at turnover or during other maintenance visits. Then, at the end of a designated 12-month period, the list will reveal which spaces have not yet been visually assessed. Owners or managers should establish the policy that visual assessments be conducted at turnover and at the time of other maintenance visits whenever possible. An example of a simple form for this purpose is provided at Form 6.2 at the end of this chapter.

Owners or managers should assure that each person performing a visual assessment:

- ✦ **Has completed a recognized course on visual assessment of deteriorated paint**, such as HUD's online course (at <http://www.hud.gov/offices/lead/training/visualassessment/h00101.htm>.) or a similar State course, or an EPA-, State- or Tribally-accredited lead-based paint inspection or risk assessment course.
- ✦ **Knows how much visible dust and paint-related debris is considered excessive.**
- ✦ **Knows whether the area in question has lead hazard controls in place** and, if so, what and where, and what constitutes failure.
- ✦ **Knows how to recognize structural or substrate problems** that may be causing paint deterioration or failure of hazard controls.
- ✦ **Knows whether to look for bare soil**, and if so, where, how to distinguish between play areas and the rest of the yard, how to determine if the total area of bare soil in the rest of the yard exceeds HUD's small amount threshold (9 square feet per property), and if the bare soil is contaminated with dust, paint chips and/or debris.
- ✦ **Knows whether to look for other optional conditions that the owner may wish to include in the visual assessment**, such as whether floors, interior window sills and window troughs are smooth and cleanable, or whether there are chewable surfaces.
- ✦ **Knows how to record observations** on forms or worksheets provided for the purpose.

2. Determining that Firms and Workers Are Qualified

Property owners and managers of target housing must ensure that the maintenance firms and workers conducting work covered by the EPA's Renovation, Repair, and Painting (RRP) Rule (see Appendix 6) are certified renovation firms which have the work supervised by certified renovators and the workers either certified renovators or property trained under the RRP Rule, as described in Section III.D, above.

3. Maintaining Records

The owner or manager should keep the following forms (all located at the end of the chapter) or reports to facilitate and document the lead-safe maintenance program:

- ✦ **Reports of visual assessments** (Forms 6.0 and 6.1, or similar forms).
- ✦ **A log of the dates of visual assessments** (Form 6.2, or similar form).
- ✦ **An inventory of lead-based paint testing results or presumption of lead-based paint or hazards, if any** (Form 6.3, or similar).
- ✦ **An inventory of lead hazard controls, if any** (Form 6.4, or similar).
- ✦ **Lead-safe maintenance work orders, if used** (Form 6.5, or similar).
- ✦ **Reports of clearance examinations.**

Inventory of lead-based paint testing. Individuals assigning maintenance tasks will need to determine whether work on certain surfaces may result in a lead hazard. The best method for doing this is to have a certified lead-based paint inspector or risk assessor determine whether lead-based paint is present (using the protocols in Chapter 7) and then maintain an easy-to-use, surface-by-surface inventory, such as that shown as Form 6.3 at the end of this chapter and illustrated by example in Form 6.3a. If paint testing is not conducted, all painted surfaces in dwellings constructed before 1978 should be presumed to contain lead-based paint, until proven otherwise. While this presumption could result in erroneously requiring controls for working on paint that does not contain lead, it would be dangerous to assume that the paint does not contain lead. A maintenance supervisor could fail to recommend controls where they are needed, resulting in a poisoned worker or child.

It is important to note that most painted surfaces in dwellings constructed before 1978 do *not* contain lead-based paint. This is especially true of buildings constructed after World War II (Jacobs, 2002). It is not unusual for entire buildings built in the 1970s to have no lead-based paint. Therefore, it frequently pays to test. The cost of testing can be returned in reduced maintenance and renovation costs. Also, if it is *known*, through *documentation*, that certain building components are new or were replaced or new materials added after 1977, it can be assumed that they do not contain lead. For example, if all exterior doors and windows in a building are known to have been replaced in 1981, these surfaces do not need to be included in the inventory of components known or presumed to contain lead-based paint. It is advisable, however, to have written documentation of the dates such additions or replacements. Reuse or reinstallation of old or antique architectural components should also be avoided.

Depending on the size and organization of the maintenance operation, the inventory could be organized by room (appropriate for small owners with only one or a few single-family dwellings) or by unit/apartment building (appropriate for larger landlords). For computerized maintenance systems, the lead-based paint inventory system can be added to the database to flag those jobs that could produce lead hazards. If workers or supervisors are unsure about whether or not they are working on a leaded surface, they can quickly consult the inventory.

Inventory of lead hazard controls. If lead hazard controls, other than *de minimis* paint stabilization or total removal of the lead-based paint, have been conducted on the property, it will be necessary to inform the visual assessor of their existence. Therefore, it is recommended that owners maintain a simple inventory of lead hazard controls that lists the location, type of hazard, method of control, and date of installation. Form 6.4 provides an example of such an inventory form.

4. Determining the Lead-Safe Work Practices To Be Used on Each Job

The methods used to protect residents, workers, and the environment on a given maintenance or renovation job depend on many factors, including the amount and dispersal of dust likely to be created by the job (which in turn is affected by the size of the surface(s) needing work, the nature of the work, and the methods being used); the location of residents; the building layout; and the proximity of the building to other properties. Consult Chapter 8 for guidance on determining whether a job is likely to generate low or high amounts of dust and on selecting occupant protection and worksite preparation methods appropriate to the job. Absent other comprehensive training on this subject (see courses described above in section IV.C.2), Chapter 8 is essential to understanding lead-safe maintenance. Also, Chapter 11 (Interim Controls) should be consulted for work practices to be used in various types of paint-disturbing work (such as paint stabilization or repair of windows or doors), and Chapter 9 provides further information on worker protection.

5. Modifying the Work Order System

Work order systems should be modified (if they have not yet been) to reflect whether the job will disturb lead-based paint, whether the job is low- or high-risk (see guidance in Chapter 8), and which protective measures will be required. Even if an owner does not have a formal work order system developed, the hazard warning information must be transmitted to those conducting the work.

To account for lead hazards, the owner's work order form will need to be modified (if it has not yet been). Specifically, a check-off box should be added to indicate that the work will disturb known or presumed lead-based paint. If this box is checked, the supervisor or worker should receive a second form (see Form 6.5 "Lead-Safe Maintenance Work Order" at the end of this chapter) with detailed information on required work practices and control measures.

6. Communicating with Residents

The EPA's Pre-Renovation Education Rule requires that persons who perform, for compensation, most renovation, repair or painting of housing built before 1978 provide, before beginning work to the owner of the housing, and to the occupant of each affected unit (a unit in which the work is being done, and/or a unit for which work in a common area that will affect that unit) (40 CFR 745.84):

- ◆ the renovation-specific pamphlet “*Renovate Right: Important Lead Hazard Information for Families, Child Care Providers and Schools*,” (www.epa.gov/lead/pubs/renovaterightbrochure.pdf, or, in Spanish, www.epa.gov/lead/pubs/renovaterightbrochuresp.pdf) or an EPA-approved State or Tribal alternate pamphlet; and
- ◆ information about how and where the project will be conducted, including the general nature and locations of the planned renovation activities; the expected starting and ending dates; and
- ◆ if the work is being conducted in common areas, ensure written notification to each affected unit with the information above and describing how the occupant can obtain the pamphlet, at no charge, from the firm performing the renovation.

This pre-renovation education is not required for: (1) minor repair and maintenance activities (see section II.C.3, above), (2) emergency renovation operations, and (3) renovations in which a certified lead-based paint inspector, certified risk assessor, or the certified renovator for the project has determined that the components disrupted by the renovation are free of lead-based paint. Detailed information on implementing pre-renovation education is provided in the EPA’s *Small Entity Compliance Guide to Renovate Right*, a handbook on the RRP rule for contractors, property managers and maintenance personnel working in homes and child-occupied facilities built before 1978 (EPA publication EPA-740-K-10-003; www.epa.gov/lead/pubs/sbcomplianceguide.pdf).

7. Purchasing Supplies and Equipment

The following is a list of some of the more important specialized materials needed to carry out lead-safe maintenance. These items, with the possible exception of quality door mats, are available at most full-service hardware stores (see Figure 6.6).

- A. Vacuum.** If possible, a high-quality, high efficiency particulate air (HEPA) vacuum should be used in cleaning. If required by EPA, HEPA vacuums must be used. If construction work is being performed, OSHA’s lead in construction regulation 29 CFR 1926.62(h)(4) requires HEPA vacuums for vacuuming. A HEPA vacuum has a filter capable of removing particles of 0.3 microns or larger from air at 99.97 percent or greater efficiency. The filters on ordinary vacuums do not capture very tiny particles of lead, allergens, and other contaminants but rather let them pass through the filter and out the exhaust. However, it is important to note that there is more to a vacuum than the filter. Other important factors that determine the effectiveness of a vacuum are suction (which is a function of the motor, the design of the suction tool, and the extent to which the rest of the system does not release air before it is supposed to), quality of construction (which may determine the durability of the machine and whether there are air pressure leaks before the filtration), and whether the vacuum has special tools, such as a beater bar or agitator attachment for carpets. Also, there are filters available that, while not HEPA, are better than those that formerly were standard on household and commercial vacuums.

Research has shown that high-quality non-HEPA vacuums are often as effective as, and sometimes more effective than, HEPA vacuums (California Department of Health Services, 2004; Rich, 2002; Yiin, 2002). Therefore, while these *Guidelines* recommend that a good HEPA vacuum should be used if possible, a high-quality household or commercial vacuum should be used if a HEPA vacuum is not available.

- B. Respirators.** Workers on high-dust jobs (see Chapter 8) should wear respirators that are rated N100 (HEPA) at a minimum. N100 rated disposable masks are available, but a fitted, half-face respirator is preferable because it is reusable and conforms to the face of the user, eliminating leaks. Disposable respirators can be \$5 to \$7, while a half-face respirator costs \$32 plus \$3 for set of cartridges. All determinations with regard to worker protection equipment, such as respirators and protective clothing, should be made in accordance with OSHA regulations for exposure monitoring and assessments. If dust levels are at or above OSHA's Permissible Exposure Limit, there are legal requirements under both 29 CFR 1910.1025 (Lead in General Industry) and 29 CFR 1926.62 (Lead in Construction) for personal protective equipment.
- C. Protective sheeting.** When lead-safe work practices are recommended, workers should use disposable, impermeable protective sheeting (such as heavy-duty polyethylene) as needed to cover floors, furniture, and HVAC ducts in the work area, construct dust-containing door flaps, and also to cover floors in passageways to and from the work area. Sheeting that is subject to the possibility of abrasion or puncture should be at least 6-mil thick, while other sheeting can be less thick.
- D. Protective clothing.** For high-dust jobs, it is recommended that workers either wear disposable protective suits (such as Tyvek™) or wear clothes that will be changed before leaving the work place and washed separately from the family laundry.
- E. Disposable shoe coverings.** An effective and relatively easy way to avoid tracking contaminated dust into non-work areas is for workers to wear inexpensive non-skid disposable shoe coverings when walking on protective sheeting and then remove the shoe coverings whenever they step off the protective sheeting.
- F. Detergents, buckets, mops and rags for wet cleaning the work area.** The supplies and equipment for wet cleaning the work area are all standard, commonly used cleaning materials (see Figure 6.6). The detergent should be a common cleaning solution, not trisodium phosphate (TSP). Not only has TSP been banned in some areas because of negative effects on the ecology of aquatic systems, but also research indicates that phosphate content is not associated with effectiveness in removing lead-contaminated dust from residential surfaces (EPA, 1997a; EPA, 1998). When cleaning floors, workers should have three buckets: one for the cleaning solution, one with a mop-squeezing tool, and one with clean water for rinsing the floor. For floors, the mop should be a string mop; sponge mops work more as a sweeping tool since it has less surface area to trap dust than string mops. Rags and sponges are recommended for cleaning walls, interior window sills, window troughs, counters, shelves and other horizontal surfaces.



FIGURE 6.6 Clean-up supplies.

Some experienced contractors have abandoned mopping in favor of a “wet wipe and toss” procedure. This method requires a large quantity of clean rags, which are put into a bucket of detergent and water solution. The worker pulls a rag from the bucket, wrings it out over the bucket, wipes clean an area of about 16 square feet, throws the used rag away, pulls another rag, and so on. If the detergent requires rinsing, repeat with clean water. For sills, troughs, counters, shelves, walls, and tight floor spaces like behind toilets, the wet wipe and toss method is the best alternative to the mop. Some contractors prefer this method even for large floor areas. A major advantage is that it avoids the potential problem of re-contaminating the area by cleaning with dirty water. This method may also use less water than a mop. The rags are commercially available disposable cloth scraps or paper products. Cloth rags usually are not cleaned and reused because of the risk of contaminating other laundry (White, 2003).

- G. Door mats.** Lead dust from outside the building can be tracked inside on the bottom of shoes, wheels on carts, and bare feet. A good doormat can be very effective in reducing the introduction of exterior dirt, dust, moisture, and various contaminants in residential and nonresidential buildings, *provided the mat is vacuumed frequently*. A good mat should have dense, synthetic fibers on a waterproof backing and should be easily cleaned by vacuuming. For best results, it should be placed in a dry location inside an exterior door, and, if possible, it should be big enough to allow people to take three or four steps on the mat. A small mat (e.g., two feet by three feet) is effective if people wipe their shoes on it. The better mats tend to be designed for commercial use and may not be available at hardware stores, except by special order.

8. Monitoring the Work and Arranging for Clearance Examinations

The person who monitors maintenance or remodeling work should be trained in lead-safe work practices and should be familiar with clearance examination procedures. There are three stages of involvement: (1) *while paint-disturbing work is underway*; (2) *during and after clean-up*; and (3) *at the time of clearance*.

The following is a minimal list of determinations that should be made while work is underway:

- ◆ ***Has the worksite been set up properly***, in accordance with the work order and guidance in Chapter 8, and does the setup appear to be working as planned?
- ◆ ***Are residents being kept out of the work area?***
- ◆ ***Are workers avoiding the use of prohibited work practices?***

- ✦ *Is waste being handled correctly?*
- ✦ *Are workers using worker protection methods appropriate to the job?*

Clean-ups should be observed in process on a random basis to assure that all horizontal surfaces are being cleaned, and every job should be inspected visually after clean-up to assure that no visible dust and debris are present in the work area and in other rooms and passageways used by the workers.

The person responsible for arranging for clearance should retain a person or firm certified to perform clearance examinations in the State. Multi-family property owners can use in-house staff to perform clearance, provided the clearance examiner is certified in the State or Tribal area and the clearance examiner does not participate in doing the maintenance or renovation work and the clean-up. Clearance should be conducted as required by regulation. Even if regulations do not require clearance, clearance examinations should be conducted randomly at a rate of at least one per twenty jobs for crews demonstrating a good record of achieving clearance on the first three tries. The timing of the clearance examination is important. Clearance dust sampling should be performed no less than one hour after clean-up has been completed to allow time for any fallout of fine dust particles. Arrangements must be made for the clearance examiner to have access to the worksite. Chapter 15 explains what a clearance examiner does and what the Federal dust-lead standards are for clearance.

On-site Dust Testing. Owners and managers should be aware that methods exist for reliably analyzing wipe samples on-site instead of in a fixed laboratory. These include portable X-ray fluorescence (XRF) analysis and anodic stripping voltammetry (ASV) (EPA, 2002b; Clark, 2002). These methods may provide testing results much more quickly than fixed-laboratory analysis because samples do not have to be transported to the laboratory. Therefore the methods may save time and money, reduce relocation difficulties, facilitate cooperation with tenants, and accelerate environmental investigations in cases of lead-poisoned children.

In States and Tribal lands where EPA is operating a lead program, wipe samples for a clearance examination must be analyzed by a laboratory or testing firm recognized by EPA under the National Lead Laboratory Accreditation Program (NLLAP). If, in these States, an NLLAP laboratory wishes to perform on-site analyses of dust wipe samples, they may do so. In States or Tribal lands where the State or Tribe is operating an EPA-authorized lead program, the same requirements generally apply, although there may be some differences (EPA, 2002a). While EPA regulations and procedures apply only to abatement activities, HUD regulations and many State regulations apply the same procedures to non-abatement activities.

In addition, any person who is trained and otherwise qualified to operate the XRF instrument or use the ASV method may use these methods to conduct *preliminary* dust testing to determine whether the clearance area is clean and ready for the clearance examination. A person conducting a preliminary screen does not have to be a technician working for an NLLAP-accredited laboratory. Owners and contractors may wish to use such screening tests to minimize the likelihood of clearance failure. State regulations on the use of devices with radioactive elements must be observed.

Form 5.2 Report of Visual Assessment (for Lead Hazard Risk Assessment).
Form 6.0 Report of Visual Assessment (for Ongoing Lead-Safe Maintenance).

Property address _____ Apt. No. _____ Page ____ of ____

Name of property owner _____

Name of risk assessor _____ Date of assessment ____/____/____

Area Description		Deteriorated Paint			Friction or Impact Surface? (F or I)	Visible Teeth Marks? (Y or N)	Paint Testing Results (Use codes below) ⁴	Notes [e.g., paint testing (e.g., XRF, lab analysis) indicates paint is or is not lead-based paint; cause(s) of hazard control failures]
Location of Building Component, Dust or Bare Soil	Building Component, Dust, or Bare Soil Play Area/ Non-Play Area	Area (sq. ft.)	Is Area Small? ² (Y or N)	Probable Cause(s) of Deterioration if Known ³				

¹ Include room equivalent or exterior side or wall, as appropriate.
² Lead-safe work practices and clearance/cleaning verification are not required if work does not disturb painted surfaces that total more than
 ♦ For assisted housing: HUD's *de minimis* area of: 20 ft² or less on exterior surfaces, 2 ft² or less in any one interior room or space, or 10 percent of the total surface area on an interior or exterior type of component with a small surface area (such as trim, window sills, baseboards);
 ♦ For unassisted housing, and for child-occupied facilities, EPA's minor repair and maintenance activities threshold of: 6 ft² or less per room; or 20 ft² or less for exterior activities; provided that no prohibited or restricted work practices were used and no window replacement or demolition of painted surface areas is to be done.
³ Common causes of paint deterioration are: moisture (indicate source if apparent), mildew, friction or abrasion, impact, damaged or deteriorated substrate, and severe heat.
⁴ Codes based on previous paint testing or lead-based paint (LBP) inspection: Code 1: Surface known to be LBP; Code 2: Surface known to be LBP; Code 3: Presumed to be LBP. If paint testing results are obtained on site, use this column to record the result. If a paint chip sample is sent to the laboratory, use this column to record the sample number (or other unique identifier) as a reference to another record containing the sampling data and laboratory results.

**Form 6.1 Report of Visual Assessment of Bare Soil
for Lead-Safe Maintenance**

Property address _____

Name of visual assessor _____ Date _____

Type of Area (play or nonplay)	Location of Each Bare Soil Area (side of building and detailed description, or code from sketch plan)	Approximate Area of Bare Soil Area (in sq. ft. or approximate dimensions)	Notes

Site-Plan Sketch Showing Locations of Bare Soil



Form 6.2 Log of Visual Assessments for Ongoing Lead-Safe Maintenance

Property address _____

Unit Number, Common Area, or Exterior	Date of Visual Assessment and Initials of Assessor			



Form 6.3 Lead-Based Paint Inventory

Property address _____

Dwelling Unit Number, Common Area, or Exterior Wall _____

Room Identifier _____

Room or Space	Component or Surface	Known Lead-Based Paint	Suspected Lead-Based Paint	Known Not To Be Lead-Based Paint

Indicate date of test that determined not lead-based paint

Form 6.3a Completed Lead-Based Paint Inventory for a Room/Space

Dwelling Unit Identifier 234

Room Identifier Dining Room

Surface	Known Lead-Based Paint	Suspected Lead-Based Paint	No Lead-Based Paint
Floors			X (6/3/2005)
Lower Walls		X	
Upper Walls		X	
Chair rail		X	
Interior window trim		X	
Window trough	X		
Ceiling		X	
Baseboards			X (6/3/2005)
Doors			X (4/15/2006)
Door trim		X	
Crown molding		X	
Other trim, mantels, etc.		X	
Exterior siding	X		

Form 6.4 Lead Hazard Control Inventory

Property address _____

Dwelling Unit, Common Area, or Exterior Location	Room/Component or, if exterior, Yard or Play Area	Description (Type of Hazard, Control Method, Date of Application or Installation)

Form 6.5 Lead-Safe Maintenance Work Order

Reference to work order number _____

Equipment and supplies needed (check items needed):

- Protective sheeting (e.g., polyethylene) Approximate amount (in yards) _____
- Disposable shoe coverings
- Protective clothing
- Respirators
- Vacuum (HEPA preferable, if available)
- Cleaning materials (detergent, buckets, mops, and rags)
- Spray bottle for misting
- Other _____

Worksite preparation (check items needed):

- Cover whole floor with protective sheeting
- Cover floor approximately five feet from work surface
- Cover floors in hallway to work area
- Cover furniture Move furniture
- Close off doorways(s) to room with protective sheeting
- Relocate occupants temporarily Just keep occupants out of work area
- Shut down HVAC system while paint-disturbing work is underway
- Other _____

Mist down paint surfaces to be disturbed (*except around electrical outlets*) Yes No

Clean-up:

Area(s) to be cleaned: _____

Vacuum horizontal surface? Yes No

Wet wash? Yes No

Clean window troughs? Yes No

Disposal of waste will be done by _____

Will clearance dust sampling be conducted Yes No

References

- Amitai, 1991. Amitai, Y., M.J. Brown, J.W. Graef, and E. Cosgrove. "Residential Deleading: Effects on the Blood Lead Levels of Lead Poisoned Children," *Pediatrics* 88(5): 893–897.
- ASTM, E 2271. American Society for Testing and Materials, "Standard Practice for Clearance Examinations Following Lead Hazard Reduction Activities in Single-Family Dwellings and Child-Occupied Facilities," ASTM, 100 Barr Harbor Drive, West Conshohocken, PA.
- California Department of Health Services, 2004. Public Health Institute for California Department of Health Services, Childhood Lead Poisoning Prevention Branch and Environmental Health Laboratory Branch, "Evaluation of Household Vacuum Cleaners in the Removal of Settled Lead Dust from Hard Surface Floors," Final Report to U.S. Department of Housing and Urban Development, 2004.
- Clark, 2002. Clark, C.S., "Development of a Rapid On-Site Method for the Analysis of Dust Wipes Using Field Portable X-Ray Fluorescence," prepared for the U.S. Department of Housing and Urban Development, January 2002.
- EPA, 1997a. U.S. Environmental Protection Agency, *Laboratory Study of Lead-Cleaning Efficacy*, March 1997 (EPA 747-R-97-002). Available through nepis.epa.gov by searching for 747R97002.
- EPA, 1997b. U.S. Environmental Protection Agency, *Lead Exposures Associated With Renovation and Remodeling Activities: Summary Report*, May 1997 (EPA 747-R-99-001). Available through nepis.epa.gov by searching for 747-R-99-001
- EPA, 1998. U.S. Environmental Protection Agency, *Lead-Cleaning Efficacy Follow-Up Study*, October 1998 (EPA 747-R-98-008).
- EPA, 1999a. U.S. Environmental Protection Agency, "Lead Exposures Associated With Renovation and Remodeling Activities: Phase IV, Worker Characterization and Blood-Lead Study of R&R Workers Who Specialize in Renovation of Old or Historic Homes," March 1999 (EPA 747-R-99-001).
- EPA, 1999b. U.S. Environmental Protection Agency, "Lead Exposures Associated With Renovation and Remodeling Activities: Phase III, Wisconsin Childhood Blood-Lead Study," March 1999 (EPA 747-R-99-002).
- EPA, 2001. U.S. Environmental Protection Agency, Identification of Dangerous Levels of Lead, *66 Federal Register* 1206-1240, January 5, 2001; at 1227.
- EPA, 2002a. U.S. Environmental Protection Agency, "Questions & Answers About ETV Reports on Portable Technologies for Measuring Lead in Dust," December 2002.
- EPA, 2002b. U.S. Environmental Protection Agency, The Environmental Technology Verification Program (ETV), Verification Statements EPA-VS-SCM-50, 51, 52, 53 and 54. Prepared by Oak Ridge National Laboratory, Oak Ridge, Tennessee, August, 2002.
- Farfel and Chisolm, 1990. Farfel, M., and J.J. Chisolm, Jr., "Health and Environmental Outcomes of Traditional and Modified Practices for Abatement of Residential Lead-Based Paint," *American Journal of Public Health* 80:10, 1240–1245. ajph.aphapublications.org/cgi/reprint/80/10/1240

HUD, 2001a. *National Survey of Lead and Allergens in Housing, Final Report, Volume I: Analysis of Lead Hazards*, prepared by Westat, Inc. for U.S. Department of Housing and Urban Development, Washington, DC, April, 2001. http://www.nmic.org/nycce/p/documents/HUD_NSLAH_Vol1.pdf

Lange, 2000. Lange, John H., K.W. Thomulka, "Effectiveness of Engineering Controls for Airborne Lead Exposure during Renovation/Demolition of a Commercial Building," *Indoor and Built Environment*, 2000:9, 207-215 (DOI: 10.1159/000057509).

Jacobs, 2002. Jacobs, D.E., R.P. Clickner, J.Y. Zhou, S.M. Viet, D.A. Marker, J.W. Rogers, D.C. Zeldin, P. Broene and W. Friedman, "The Prevalence of Lead-Based Paint Hazards in US Housing," *Environmental Health Perspectives*, 110(10):599, October 2002. <http://www.ncbi.nlm.nih.gov/pubmed/12361941>

NCHH, 2004. National Center for Healthy Housing, and University of Cincinnati Department of Environmental Health, *Evaluation of the HUD Lead-Based Paint Hazard Control Grant Program: Final Report*, prepared for the U.S. Department of Housing and Urban Development, Washington, DC, May 1, 2004.

NIOSH, 1990. National Institute for Occupational Safety and Health, *Health Hazard Evaluation Report: HUD Lead Based Paint Abatement Demonstration Project*, HETA 90-070-2181.

Rabinowitz, 1985a. Rabinowitz, M., A. Leviton, and D. Bellinger, "Home Refinishing, Lead Paint, and Infant Blood Lead Levels," *American Journal of Public Health* 75(4): 403-404. ajph.aphapublications.org/cgi/reprint/75/4/403.pdf

Rich, 2002. Rich, David Q., G.G. Rhoads, L. Yiin, J. Zhang, Z. Bai, J.L. Adgate, P.J. Ashley and P.L. Lioy, "Comparison of Home Lead Dust Reduction Techniques on Hard Surfaces: The New Jersey Assessment of Cleaning Techniques Trial," *Environmental Health Perspectives*, 110(9): 889-893, September 2002. ehp.niehs.nih.gov/members/2002/110p889-893rich/rich-full.html

White, 2003. White, K. and G. Dewalt, Unpublished comments on proposed revisions to Chapter 14 of the HUD *Guidelines*, May 2003.

Yiin, 2002. Yiin, Lih-Ming, F.F. Rhoads, D.Q. Rich, J. Zhang, Z. Bai, J.L. Adgate, P.J. Ashley and P.J. Lioy, "Comparison of Techniques to Reduce Residential Lead Dust on Carpet and Upholstery: The New Jersey Assessment of Cleaning Techniques Trial," *Environmental Health Perspectives*, 110(12): 1-5, December, 2002. <http://ehp03.niehs.nih.gov/article/fetchArticle.action?articleURI=info%3Adoi%2F10.1289%2Fehp.021101233>

Zhu, 2012. Zhu, J., E. Franko, N. Pavelchaka and R. DePersis. Worker Lead Poisoning during Renovation of a Historic Hotel Reveals Limitations of the OSHA Lead in Construction Standard. *Journal of Occupational and Environmental Hygiene*. 9:8. Published online June 25, 2012, published on paper, August 9, 2012. DOI: 10.1080/15459624.2012.700273

Chapter 7: Lead-Based Paint Inspection

HOW TO DO IT	7-5
I. Introduction	7-8
A. Purpose	7-8
1. Disclosure of Inspections	7-9
2. Limitation of this Inspection Protocol	7-9
3. Documentation of Results	7-9
4. Owner's Use of Inspection Reports in Lead Disclosure	7-9
B. Qualifications of Inspectors and Laboratories	7-10
1. Where to Find Inspectors and Laboratories	7-10
2. Qualifications of Inspectors	7-10
C. Other Sources of Information	7-10
1. XRF Performance Characteristic Sheet	7-10
2. XRF Radiation Protection Regulations	7-11
3. ASTM and NIST Standards	7-11
D. Paint Testing for Inspections and Risk Assessments	7-11
E. Most Common Inspection Method	7-12
F. XRF Performance Characteristic Sheets and Manufacturer's Instructions	7-13
G. Inspection by Paint-chip Analysis	7-13
H. Additional Means of Analyzing Paint	7-14
1. Mobile Laboratories	7-14
2. Chemical Test Kits	7-14
II. Summary of XRF Radiation Safety Issues	7-16
III. Definitions	7-16
IV. Inspections in Single-Family Housing	7-19
A. Listing Testing Combinations	7-20
1. Number of Room Equivalents to Inspect	7-20
2. Number of Testing Combinations to Inspect	7-20
3. Painted Furniture	7-21
4. Ceramic Tile and Other Fixtures.....	7-21
5. Building Component Types	7-21
6. Substrates	7-21
B. Number and Location of XRF Readings	7-22
1. Number of XRF Readings for Each Testing Combination	7-22
2. Location of XRF Readings	7-22
3. Documentation of XRF Reading Locations	7-22
C. XRF Instrument Reading Time	7-24
D. XRF Calibration Check Readings	7-25

1.	Frequency and Number of Calibration Checks	7-25
2.	Calibration Check Standard Materials	7-25
3.	Recording and Interpreting Calibration Check Readings	7-26
E.	Substrate Correction	7-26
1.	When Substrate Correction Is Not Required	7-27
2.	Substrate Correction Procedure	7-27
3.	Negative Values	7-29
F.	Discarding Readings	7-29
G.	Classification of XRF Results	7-29
H.	Evaluation of the Quality of the Inspection	7-30
1.	Direct Observation	7-31
2.	Immediate Provision of Results	7-31
3.	Repeated Testing of 10 Surfaces	7-31
4.	Time-and-Motion Analysis	7-32
I.	Documentation in Single-Family Housing	7-32
1.	Data Forms	7-32
2.	Electronic Data Storage	7-32
3.	Final Report	7-32
V.	Inspections in Multi-family Housing	7-36
A.	Statistical Confidence in Dwelling Unit Sampling	7-36
B.	Selection of Housing Units, Common Areas, and Exterior Site Areas	7-37
C.	Listing Testing Combinations and Common Areas	7-41
D.	Classification of XRF Results in Multi-family Housing	7-41
1.	Unsampled Housing Units	7-44
2.	Fewer than 5% Positive Results	7-45
E.	Documentation in Multi-family Housing	7-45
VI.	Laboratory Testing for Lead in Paint-chip Samples	7-45
A.	Number of Samples	7-46
B.	Size of Samples	7-46
C.	Inclusion of Substrate Material	7-46
D.	Repair of Sampled Locations	7-46
E.	Classification of Paint-chip Sample Results	7-47
F.	Units of Measure	7-47
G.	Sample Containers	7-47
H.	Laboratory Analysis Methods	7-48
I.	Laboratory Selection	7-49
J.	Laboratory Report	7-50
VII.	XRF Hazards	7-50
A.	Licenses and Certifications for Using XRFs with Radioactive Sources	7-51
B.	Safe Operating Distance	7-52

REFERENCES	7-53
ADDENDUM 1: EXAMPLES OF LEAD-BASED PAINT INSPECTIONS.....	7-54
A. Example of a Single-Family Housing Inspection	7-54
B. Example of Multi-family Housing Inspection	7-56
ADDENDUM 2: DATA COLLECTION FORMS	7-61
Form 7.1 Single Family Housing LBP Testing Data Sheet – Blank	
Form 7.1 Single Family Housing LBP Testing Data Sheet – Completed	
Form 7.2 Calibration Check Test Results – Blank	
Form 7.2 Calibration Check Test Results – Completed	
Form 7.3 Substrate Correction Values – Blank	
Form 7.3 Substrate Correction Values – Completed	
Form 7.4 Selection of Housing Units – Blank	
Form 7.4 Selection of Housing Units – Completed	
Form 7.5 Multi-family Housing LBP Testing Data Sheet – Blank	
Form 7.5 Multi-family Housing LBP Testing Data Sheet – Completed	
Form 7.6 Multi-family Housing: Component Type Report – Blank	
Form 7.6 Multi-family Housing: Component Type Report – Completed	
ADDENDUM 3: XRF PERFORMANCE CHARACTERISTICS SHEETS.....	7-74
FIGURES	
Figure 7.1 One type of XRF instrument displays its reading of a testing combination	7-12
Figure 7.2 Child’s bed showing teeth marks in painted surface	7-21
Figure 7.3 Multi-family Decision Flowchart	7-43
Figure 7.4 Preparation to take paint chip sample	7-46
Figure 7.5 Removing paint chip sample	7-46
Figure 7.6 Damage caused by removing paint chip sample	7-47
Figure 7.7 Inspectors must operate XRFs at safe distance from others.....	7-52
TABLES	
Table 7.1 Examples of Interior and Exterior Building Component Types.....	7-18
Table 7.2 Examples of Distinct Testing Combinations.....	7-19
Table 7.3 Number of Units to Be Tested in Multi-family Building or Developments.....	7-38



Intentionally Left Blank

Chapter 7: Lead-Based Paint Inspection

How to Do It

1. See Chapters 3, 5 and 16 for guidance on when a lead-based paint inspection is appropriate. A lead-based paint inspection will determine:
 - ◆ Whether lead-based paint is present in a house, dwelling unit, residential building, housing development, or child-occupied facility, including common areas and exterior surfaces; and
 - ◆ If present, which building components contain lead-based paint.

The U.S. Department of Housing and Urban Development (HUD) and the U.S. Environmental Protection Agency (EPA) define an inspection as a surface-by-surface investigation to determine the presence of lead-based paint and the provision of a report explaining the results of the investigation. The sampling protocols in this chapter fulfill that definition.

2. The client should hire a certified (licensed) lead-based paint inspector or risk assessor (see 40 CFR part 745). Lists of certified lead-based paint inspectors and risk assessors can be obtained from the EPA website at: www.epa.gov/oppt/lead/pubs/traincert.htm. Laboratories recognized by EPA, under its National Lead Laboratory Accreditation Program (NLLAP), for analysis of lead in paint can also be found at www.epa.gov/oppt/lead/pubs/nllap.htm.
3. The inspector should use the HUD/EPA standard for lead-based paint of equal to or greater than 1.0 mg/cm² or 0.5% by weight, as defined by Title X of the Housing and Community Development Act of 1992 (unless HUD and EPA have lowered the standard). If the applicable standard in the jurisdiction is more stringent, the procedures in this chapter will need to be modified. For purposes of the HUD/EPA Lead-Based Paint Disclosure Rule, 1.0 milligrams per square centimeter (mg/cm²) or 0.5% by weight are the standards that must be used (see Appendix 6) as of the publication of this edition of these *Guidelines*. If a State, Tribe or local government has an EPA-authorized plan for certifying lead-based paint inspectors and has lower lead standards, those lower lead standards would apply to inspections (but not to the Lead Disclosure Rule; paint with lead below the federal threshold is not considered lead-based paint for purposes of that Rule).

There are other analytical techniques that may be used by a laboratory with NLLAP recognition for analysis of lead in paint.

4. Obtain the *XRF Performance Characteristic Sheet (PCS)* for the X-Ray Fluorescence (XRF) lead paint analyzer to be used in the inspection. It will specify the ranges where XRF results are positive, negative or inconclusive, the calibration check tolerances, and other important information. Only devices with a posted PCS may be used for lead paint inspections. If you use a XRF without a current PCS, or do not follow the requirements of the PCS, the work will be considered invalid, and not an inspection or paint testing, as applicable, and the work will have to be re-done. To obtain the appropriate *XRF Performance Characteristic Sheet*, contact the National Lead Information Center Clearinghouse (1-800-424-LEAD) or download it from the Internet at www.hud.gov/offices/lead/lbp/hudguidelines/allpcs.pdf. *XRF Performance Characteristic Sheets* have been developed by HUD and EPA for most commercially available XRFs. (Hearing- or speech-challenged individuals may access this number through TTY by calling the toll-free Federal Relay Service at 800-877-8339.) *Report lead paint amounts in mg/cm²* because this unit of measurement does not depend on the number of layers of

non-lead-based paint and can usually be obtained without damaging the painted surface. All measurements of lead in paint should be in mg/cm², unless the surface area cannot be measured or if all paint cannot be removed from the measured surface area. In such cases, concentrations may be reported in weight percent (%) or parts per million by weight (ppm).

5. If the XRF instrument has a radioactive source, follow the radiation safety procedures explained in this chapter, and as required by the U.S. Nuclear Regulatory Commission and applicable State and local regulations when using XRF instruments.
6. Take at least three calibration check readings before beginning the inspection. Additional calibration check readings should be made at least every 4 hours, after inspection work has been completed for the day, or according to the manufacturer's instructions, whichever is most frequent. If the instrument is to be turned off during the course of an inspection, calibration checks should always be done before the instrument is turned off and again after it has been warmed up (calibration checks do not need to be done each time an instrument enters an automatic "sleep" state while still powered on).
7. When conducting an inspection in a multi-family housing development or building, obtain a complete list of all housing units, common areas, and exterior site areas. Determine which can be grouped together for inspection purposes based on similarity of construction materials and common painting histories. In each group of similar units, similar common areas, and similar exterior sites, determine the minimum number of each to be inspected from the tables in this chapter. Random selection procedures are explained in this chapter.
8. For each unit, common area, and exterior site to be inspected, identify all testing combinations in each room equivalent. A testing combination is characterized by the room equivalent, the component type, and the substrate. A room equivalent is an identifiable part of a residence (e.g., room, house exterior, foyer, etc.). Painted surfaces include any surface coated with paint, shellac, varnish, stain, paint covered by wallpaper, or any other coating. Wallpaper should be assumed to cover paint unless building records or physical evidence indicates no paint is present.
9. Take at least one individual XRF reading on each testing combination in each room equivalent. For walls, take at least four readings (one reading on each wall) in each room equivalent. A different visible color does not by itself result in a separate testing combination. It is not necessary to take multiple XRF readings on the same spot, as was previously recommended, unless the PCS requires such for the XRF instrument being used.
10. Determine whether to correct the XRF readings for substrate interference by consulting the *XRF Performance Characteristic Sheet*. If test results for a given substrate fall within the substrate correction range, take readings on that bare substrate scraped completely clean of paint, as explained in Section IV.E of this chapter.
11. Classify XRF results for each testing combination. Readings above the upper limit of the inconclusive range are considered positive, while readings below the lower limit of the inconclusive range are considered negative. Readings within the inconclusive range (including its boundary values) are classified as inconclusive. Some instruments have a threshold value separating ranges of readings considered positive from readings considered negative for a given substrate. Readings at or above the threshold are considered positive, while readings below the threshold are considered negative.
12. In single-family housing inspections, all inconclusive readings must be confirmed in the laboratory, unless the client wishes to assume that all inconclusive results are positive. Such an assumption may reduce the cost of an inspection, but will probably increase subsequent abatement, interim control, and maintenance costs, because laboratory analysis often shows that testing combinations with inconclusive readings do not in fact contain lead-based paint. Inconclusive readings cannot be assumed to be negative.

13. In multi-family dwelling inspections, XRF readings are aggregated across units and room equivalents by component type. Use the flowchart provided in this chapter (Figure 7.3) to make classifications of all testing combinations or component types in the development as a whole, based on the percentages of positive, negative, and inconclusive readings.
14. If the inspector collected paint-chip samples for analysis, they must be analyzed by a laboratory recognized under the EPA's National Lead Laboratory Accreditation Program (NLLAP) for analysis of lead in paint, and collected in accordance with ASTM E 1729, Standard Practice for Field Collection of Dried Paint Samples for Subsequent Lead Determination, or equivalent. Paint-chip samples are collected when the overall results for a component type are inconclusive by XRF, or were not measured by XRF, or if the inspector chooses to do so if the paint is deteriorated. They may be collected by a properly trained and certified inspector or others, if permitted by State law and recognized by EPA. Paint-chip samples should contain all layers of paint (not just peeled layers) and must always include the bottom layer. If results will be reported in mg/cm², including a small amount of substrate with the sample will not significantly bias results. Substrate material should not, however, be included in samples reported in weight percent. Paint from 4 square inches (25 square centimeters) should provide a sufficient quantity for laboratory analysis. Smaller surface areas may be used, but only if the laboratory indicates that a smaller sample is acceptable. In all cases, the surface area sampled must be recorded.
15. The client or client's representative should evaluate the quality of the inspection using the procedures in this chapter.
16. The inspector will prepare an inspection report indicating if and where lead-based paint is located in the unit or the housing development (or building). Inspection reports contain detailed information on the following:
 - ◆ Who performed the inspection;
 - ◆ Date(s);
 - ◆ Inspector's certification number;
 - ◆ All XRF readings;
 - ◆ Classification of all surfaces into positive or negative (but not inconclusive) categories, based on XRF and laboratory analyses;
 - ◆ Specific information on the XRF and laboratory methodologies;
 - ◆ Housing unit and sampling location identifiers;
 - ◆ Results of any laboratory analyses; and
 - ◆ Additional information described in Section IV of this chapter.
17. The report should include a statement that the presence of lead-based paint and the report must be disclosed by the owner (seller / lessor) to prospective new buyers (purchasers) and renters (lessees) of target housing prior to obligation under a sales contract or lease, except that the disclosure does not have to be made when the property is being leased if it is lead-based paint free. (See the discussion of Lead Disclosure Rule in Appendix 6.) The suggested language in the boxes in Section I.A.4 may be used.

I. Introduction

A. Purpose

This chapter explains methods for performing lead-based paint inspections in housing to determine:

- ◆ Whether lead-based paint is present in a house, dwelling unit, residential building, housing development, or child-occupied facility, including common areas and exterior surfaces; and
- ◆ If present, which building components contain lead-based paint.

The information presented here is intended for both inspectors and persons who purchase inspection services (clients). This chapter provides an inspection protocol, methods for determining the quality of an inspection, and information on how to locate certified lead inspectors.

Defining lead-based paint. Title X (“ten”) of the Housing and Community Development Act of 1992, defines lead-based paint inspection (in two places, with slightly different formatting of the same wording) as:

a surface-by-surface investigation to determine the presence of lead-based paint as provided in section 302(c) of the Lead-Based Paint Poisoning Prevention Act and the provision of a report explaining the results of the investigation. (15 U.S.C. 2681(7), for use by EPA and its stakeholders; and 42 U.S.C. 4851(12), for use by HUD and its stakeholders)

This definition in Title X is based on, and mentions, the earlier Lead-Based Paint Poisoning Prevention Act (Public Law 91-695), enacted in 1971, which described an inspection in its section 302(c) as being an:

inspection of all intact and nonintact interior and exterior painted surfaces of housing subject to this section for lead-based paint using an approved x ray fluorescence analyzer, atomic absorption spectroscopy, or comparable approved sampling or testing technique. A certified inspector or laboratory shall certify in writing the precise results of the inspection. If the results equal or exceed a level of 1.0 milligrams per centimeter squared or 0.5 percent by weight, the results shall be provided to any potential purchaser or tenant of the housing. (42 U.S.C. 4822(c))

The sampling and testing protocols in this chapter fulfill the definition of lead-based paint inspection, in providing guidance on selecting building components of housing to sample and/or test them and the methods for determining whether they are coated with lead-based paint.

Section 302(c) of the 1971 act, above, established the threshold for lead-based paint as a surface concentration (or “loading”) on the basis of weight of lead per area of surface, at 1 mg/cm², or a weight concentration on the basis of a weight of lead per weight of paint, at 0.5% by weight. That section also has wording providing for HUD to review the lead-based paint threshold and reduce it if “reliable technology makes feasible the detection of a lower level and medical evidence supports the imposition of a lower level.” As of the publication of this edition of these *Guidelines*, in response to a petition received by the EPA on August 10, 2009, HUD and EPA are collaboratively considering whether to lower the threshold level of lead-based paint; they are also looking into whether to lower the lead dust hazard standards.

HUD, consistent with EPA, CDC and OSHA, notes that paint with lead that is deteriorated or disturbed, even if its lead content is below the current EPA and HUD standards, may still pose a human health hazard, this depends largely on how much lead-contaminated dust is generated from the paint and where

that dust is dispersed. Accordingly, HUD recommends, in these *Guidelines*, using lead-safe methods of working with paint that is known or presumed to have lead in it, whether or not it is lead-based paint.

1. Disclosure of Inspections

Federal law requires the disclosure of knowledge of lead-based paint and lead-based paint hazards, or that there is no such knowledge, when owners sell or rent most pre-1978 housing, known as “target” housing. Therefore the results (that is, reports and records) of lead-based paint inspections (as discussed in this Chapter) and risk assessments (as discussed in Chapter 5) must be disclosed to prospective renters (lessees, tenants) of target housing prior to entering into a new lease and renters renewing an old lease (unless the results were previously disclosed to them), if lead-based paint is found, and to prospective purchasers prior to obligation under a sales contract for target housing, whether or not lead-based paint is found. If the inspection described in this chapter finds that lead-based paint is not present in units which are to be leased, the dwelling unit and, for multi-family housing, all other dwelling units characterized by the inspection are exempt from disclosure requirements for rental actions. However, for dwelling units which are being sold (not leased), the owner still has certain legal responsibilities to fulfill under Federal law *even if no lead-based paint is identified*. See the HUD and EPA regulations in 24 CFR part 35, and 40 CFR part 745, respectively, for additional details, and see the regulatory overview in Appendix 6.

You may contact the National Lead Information Center Clearinghouse (1-800-424-LEAD) to obtain HUD and EPA brochures, question-and-answer booklets, the regulations mentioned above (and the descriptive preamble to those regulations), and other information on lead-based paint disclosure. (Hearing- or speech-challenged individuals may access this number through TTY by calling the toll-free Federal Relay Service at 800-877-8339.) See section IV for recommended inspection report language regarding these disclosure requirements.

2. Limitation of this Inspection Protocol

The protocol described here is not intended for investigating housing units where children with elevated blood lead levels are currently residing. Such a protocol can be found in chapter 16 or from the State or local health department; the most stringent investigation protocol should be used.

3. Documentation of Results

The complete set of forms provided at the end of this chapter for use in single-family and multi-family housing may be used; similar forms or computerized reports may also be used to document the results of inspections.

4. Owner’s Use of Inspection Reports in Lead Disclosure

In the final report on the inspection, the inspector should advise the client (typically the property owner or manager) that, if the housing is target housing, the owner has certain responsibilities under the Lead Disclosure Rule when the property is being sold or leased, or when a lease is being renewed with revisions. In general, lead disclosure is required in these circumstances, except that disclosure does not have to be made when the target housing is being leased if the inspection has found that it is lead-based paint free.

See the discussion of Lead Disclosure Rule (24 CFR part 35, subpart A, or 40 CFR part 745, subpart F) in Appendix 6 of these *Guideline*). The suggested language in the boxes in Section IV.I.3, Final Report, below, may be used in the cases of lead-based paint being identified, or not identified, in target housing.

B. Qualifications of Inspectors and Laboratories

1. Where to Find Inspectors and Laboratories

Lists of EPA and State-licensed (certified) inspectors can be obtained from the National Lead Information Center Clearinghouse at 800-424-LEAD (5323). The Clearinghouse can also help you locate the appropriate State agency contact to obtain lists of State-licensed (certified) inspectors and other information.

You can go to EPA's Lead Abatement Professionals page, <http://www.epa.gov/oppt/lead/pubs/traincert.htm>, and click on the map for individual states and tribes which are authorized by EPA to operate their own lead certification programs. For other states, you can click on the Where You Live link on the left column, or go directly to <http://www.epa.gov/oppt/lead/pubs/leadoff1.htm>, to find the contact information for the EPA Regional Lead Coordinators.

Laboratories recognized under the EPA's National Lead Laboratory Accreditation Program (NLLAP) are updated monthly, and are available at <http://www.epa.gov/oppt/lead/pubs/nllaplist.pdf>.

2. Qualifications of Inspectors

An inspector must be certified (licensed) by the State or tribe where the testing is to be done if the State or tribe has an EPA-authorized inspection certification program. If the State does not have such a program, the inspector must be certified by EPA. The list of EPA-authorized states and tribes is at the EPA's Lead Abatement Professionals web page identified above.

C. Other Sources of Information

Other sources of information and materials needed for using this protocol include an XRF Performance Characteristic Sheet, U.S. Nuclear Regulatory Commission and State radiation protection regulations, and standards issued by the American Society for Testing and Materials (ASTM). The National Institute of Standards and Technology (NIST) produces Standard Reference Materials (SRMs) and provides supporting documentation for these materials.

1. XRF Performance Characteristic Sheet

An XRF Performance Characteristic Sheet (PCS) defines acceptable operating specifications and procedures for each model of X-Ray Fluorescence (XRF) lead-based paint analyzer. An inspector must follow the XRF Performance Characteristic Sheet for all inspection activities. XRF PCSs are available from the National Lead Information Center Clearinghouse or through the HUD website at <http://www.hud.gov/offices/lead/lbp/hudguidelines/allpcs.pdf>. If an XRF analyzer does not have a PCS, or if it is not used, or if the data are not analyzed, in accordance with its PCS, the actions undertaken with it are neither a lead-based paint inspection nor paint testing.

2. XRF Radiation Protection Regulations

Regulations that govern radioactive sources used in XRFs are available from State radiation protection agencies (see <http://nrc-stp.ornl.gov>) and the Nuclear Regulatory Commission (NRC). The NRC may be contacted toll-free at (800) 368-5642, or <http://www.nrc.gov/about-nrc/organization/fsmefuncdesc.html>. (Hearing- or speech-challenged individuals may access this number through TTY by calling the toll-free Federal Relay Service at 800-877-8339.) Employers of individuals who use XRF that have radioactive sources should also see OSHA's Ionizing Radiation standard, 29 CFR 1910.1096, and NRC's Standards for Protection Against Radiation, 10 CFR Part 20.

3. ASTM and NIST Standards

Other helpful information and standards are available from ASTM International at (610) 832-9585, or www.astm.org/Standard/index.shtml including:

- ✦ ASTM E1605 Standard Terminology Relating to Lead in Buildings
- ✦ ASTM E1613 Standard Test Method for Determination of Lead by Inductively Coupled Plasma Atomic Emission Spectrometry (ICP-AES), Flame Atomic Absorption Spectrometry (FAAS), or Graphite Furnace Atomic Absorption Spectrometry (GFAAS) Techniques
- ✦ ASTM E 1645 Standard Practice for Preparation of Dried Paint Samples by Hotplate or Microwave Digestion for Subsequent Lead Analysis
- ✦ ASTM E1729 Standard Practice for Field Collection of Dried Paint Samples for Subsequent Lead Determination
- ✦ ASTM E1775 Standard Guide for Evaluating Performance of On-Site Extraction and Field-Portable Electrochemical or Spectrophotometric Analysis for Lead
- ✦ ASTM E1979 Standard Practice for Ultrasonic Extraction of Paint, Dust, Soil, and Air Samples for Subsequent Determination of Lead
- ✦ ASTM E2052 Standard Guide for Evaluation, Management, and Control of Lead Hazards in Facilities (As of the publication of this edition of these *Guidelines*, this withdrawn standard being reinstated pending comprehensive updates.)
- ✦ ASTM E2120 Standard Practice for Performance Evaluation of the Portable X-Ray Fluorescence Spectrometer for the Measurement of Lead in Paint Films

NIST (301-975-2200 or <http://www.nist.gov/>; hearing- or speech-challenged individuals may access this number through TTY by calling the toll-free Federal Relay Service at 800-877-8339.) has developed a series of paint films that have known amounts of lead-based paint and can be used for calibration check purposes. As of the publication of this edition of these *Guidelines*, NIST Standard Reference Material 2579a is available (see section IV.D, below).

D. Paint Testing for Inspections and Risk Assessments

While risk assessments determine the presence of lead-based paint *hazards*, inspections determine the presence of *lead-based paint*. The paint chip sampling and measurement procedures used in

lead-based paint inspections are similar to the procedures for paint sampling used in risk assessment. However, the number of paint measurements or samples taken for a paint inspection is, generally, considerably greater than the number of paint samples required for a risk assessment, because risk assessments measure lead in paint are only made for deteriorated paint, not all paint. Inspections measure lead in both deteriorated and intact paint, which involves many more surfaces. Risk assessments always note the condition of paint on surfaces; inspections may not. For dwellings in good condition, a full risk assessment may be unnecessary, and a lead hazard screen risk assessment may be conducted. In a lead hazard screen or risk assessment, the certified risk assessor tests only painted surfaces in deteriorated condition for their lead content. See chapter 5 for methods to determine the condition of paint when conducting a risk assessment.

E. Most Common Inspection Method

Portable XRF lead-based paint analyzers are the most common primary analytical method for inspections in housing because of the demonstrated ability to determine if lead-based paint is present on many surfaces and to measure the paint without destructive sampling or paint removal, as well as the high speed and low cost per sample (see Figure 7.1). Portable XRF instruments expose a building component to electromagnetic radiation in the form of X-rays or gamma radiation. In response to radiation, each element, including lead, emits energy at a fixed and characteristic level. Emission of characteristic x-rays is called "X-Ray Fluorescence," or XRF. The energy released is measured by the instrument's fluorescence detector and displayed. The inspector must then compare this displayed value (reading) with the threshold or inconclusive range specified in the XRF Performance Characteristic Sheet (PCS) for the specific XRF instrument being used, and the specific substrate beneath the painted surface (see section IV.F, below). For instrument – substrate combinations that have a threshold:



FIGURE 7.1 One type of XRF instrument displays its reading of a testing combination.

- ◆ If the reading is less than the threshold, then the reading is considered negative for lead-based paint.
- ◆ If the reading is greater than or equal to the threshold, then the reading is considered positive.

For instrument – substrate combinations that have an inconclusive range:

- ◆ If the reading is less than the lower boundary of the inconclusive range, then the reading is considered negative.
- ◆ If the reading is within the inconclusive range, including its boundary values, then the reading is considered inconclusive.
- ◆ If the reading is greater than the upper boundary of the inconclusive range, then the reading is considered positive.

As of the publication of this edition of these *Guidelines*, the detection elements and software of all of the XRF analyzers for which HUD has issued PCSs, all of the inconclusive ranges and/or thresholds are based on 1.0 mg/cm², so that positive and negative readings are consistent with the HUD definition of

lead-based paint for identification and disclosure purposes. Laboratory analysis is recommended to confirm inconclusive XRF results, as mentioned in Section I.G, below; alternatively, the paint can be presumed to be lead-based paint.

F. XRF Performance Characteristic Sheets and Manufacturer's Instructions

When an XRF instrument is used for testing paint in target housing or pre-1978 child-occupied facilities, it must have a HUD -issued XRF Performance Characteristic Sheet. XRFs must be used in accordance with the manufacturer's instructions and the PCS. The PCS contains information about XRF readings taken on specific substrates, calibration check tolerances, interpretation of XRF readings (see section I.E, above), and other aspects of the model's performance.

If discrepancies exist among the PCS, the HUD *Guidelines* and the manufacturer's instructions, the most stringent guidelines should be followed. For example, if the PCS has a lower (more stringent) calibration check tolerance than the manufacturer's instructions, the PCS should be followed.

These *Guidelines* and the PCS are applicable to all XRF instruments that detect K X rays, L X rays, or both. Most XRF instruments in use at the time of publication of this edition of these *Guidelines* detect K-shell fluorescence (X-ray energy), some instruments, L-shell fluorescence, and some, both K and L fluorescence. In general, L X rays released from greater depths of paint are less likely to reach the surface than are K X rays, which makes detection of lead in deeper paint layers by L X rays alone more difficult. However, L X rays are less likely to be influenced by substrate effects.

G. Inspection by Paint-chip Analysis

Performing inspections by the sole use of laboratory paint-chip analysis is not recommended because it is time-consuming, costly, and requires extensive repair of painted surfaces. Laboratory analysis of paint-chip samples is recommended for inaccessible areas or building components with irregular (non-flat) surfaces that cannot be tested using XRF instrumentation. Laboratory analysis is also recommended to confirm inconclusive XRF results, as specified on the applicable XRF Performance Characteristic Sheet, or at the inspector's professional judgment. Some newer laboratory analytical methods can provide results within minutes (see section I.H, below). Only laboratories recognized under the EPA NLLAP may be used for analyzing samples of paint in target housing or pre-1978 child-occupied facilities. Laboratory analysis is more accurate and precise than XRF, but only if great care is used to collect and analyze the paint-chip sample. Laboratory results of paint chip samples should be reported as mg/cm². Appendix 1 of these *Guidelines* explains why units of mg/cm² are not dependent on the number of overcoats of lead-free paint and why such units of measure are therefore more reliable than weight percent. The dimensions of the area from which a paint-chip sample is removed must be measured as accurately as possible (to the nearest millimeter or 1/16th of an inch) and the sample has to include every layer of paint with minimal substrate included.

Although laboratory results can also be reported as a percentage of lead by weight of the paint sample, percents should only be used when it is not feasible to use mg/cm². These two units of measure are not interchangeable. Laboratory results should be reported as mg/cm² if the surface area can be accurately measured and if all paint within that area is collected.

In mg/cm² measurements, keep the amount of substrate material as small as possible so that the inclusion of the substrate in the sample risks biasing the results as little as possible. However, if reporting weight percent measurements, no substrate may be included because the substrate will "dilute" the amount of lead reported. If a visual examination shows that the bottom layer of paint appears to have "bled" into the substrate, a very thin upper portion of the substrate should

be included in the sample to ensure that all lead within the sample area has been included in the sample. Direct the laboratory to report lead in mg/cm^2 if significant amounts of substrate are included in the sample. If the classification of presence or absence of lead-based paint based on weight percent and mg/cm^2 do not agree (e.g., weight percent exceeds the standard while mass per area value is below the standard) and the contradictory results cannot be resolved the report should state that lead-based paint is present.

See section VI for additional information on laboratory analysis.

H. Additional Means of Analyzing Paint

Methods of analyzing lead in paint are available in addition to XRF and laboratory paint-chip analysis, including transportable instruments and chemical test kits. Because some of these methods involve paint removal or disturbance, repair is needed after sampling, unless the substrate will be removed, encapsulated, enclosed, or repainted before occupancy (see section VI), or if analysis shows that the paint is not lead-based paint, and leaving the damage is acceptable to the client and/or the owner.

1. Mobile Laboratories

Portable instruments that employ anodic stripping voltammetry (ASV) and potentiometric stripping analysis (PSA) are now available. Their use is described in ASTM E1775-07 Standard Guide for Evaluating Performance of On Site Extraction and Field Portable Electrochemical or Spectrophotometric Analysis for Lead, (www.astm.org/Standard/index.shtml) which may be used as a basis for evaluating the performance of on-site extraction and electrochemical and spectrophotometric analyses.

In states and tribal lands where EPA is operating a lead program, paint samples for an inspection must be analyzed by a laboratory or testing firm recognized by EPA under the National Lead Laboratory Accreditation Program (NLLAP). If, in these states, an NLLAP laboratory wishes to perform on-site analyses of paint samples, it may do so if its NLLAP recognition includes the type of laboratory operation to be used, whether a mobile laboratory, or a field sampling and measurement organization. See the NLLAP Laboratory Quality System Requirements (LQSR). (As of the publication of this edition of these *Guidelines*, NLLAP was using Revision 3.0 of the LQSR, dated November 5, 2007. <http://www.epa.gov/lead/pubs/lqsr3.pdf>, especially pages 1-2, 7, 12, and 18-19.) In states or tribal lands where the state or tribe is operating an EPA-authorized lead program, the same requirements generally apply, although there may be some differences.

2. Chemical Test Kits

Chemical test kits, also known as spot test kits, are intended to show a color change when a part of the kit makes contact with the lead in lead-based paint. Because of how long it has been since the application of lead-based paint in residential units was banned, often the surface coat does not contain significant levels of lead. Therefore many spot test kits require exposing all the layers of paint by slicing or some other method.

One type of chemical test kit is based on the formation of lead sulfide, which is black, when lead in paint reacts with sodium sulfide. Another is based on the formation of a red or pink color when lead in paint reacts with sodium rhodizonate.

Although EPA did not find chemical spot test kits sufficiently reliable for use in lead-based paint inspections, and the Agency recommended that they not be used (EPA, 1995b), it appeared that some spot test kits, when used by trained professionals, may be reliable as negative screens (NIST, 2000). During its development of its 2008 Lead Renovation, Repair and Painting Program (RRP) rule (see Appendix 6), EPA published “Lead Paint Test Kit Development; Request for Comments” (71 Federal Register 13561-13563, March 16, 2006) in order to encourage the further development of this method. In the RRP Rule, EPA described criteria for lead test kits that detect lead in paint (<http://www.epa.gov/lead/pubs/testkit.htm>).

Specifically, at 40 CFR 745.88(b)(4) and (c), the RRP rule requires a test kit newly recognized (i.e., after September 1, 2010) by EPA to meet both:

- ◆ The negative response criterion: That a false negative response (a negative response, indicating that lead-based paint is not detected) occurs no more than 5 percent of the time for paint at or above the current standard for lead-based paint (1.0 mg/cm² or 0.5 percent by weight), with 95 percent confidence; and
- ◆ The positive response criterion: That a false positive response (a positive response, indicating that lead-based paint is detected) occurs no more than 10 percent of the time for paint below the current standard for lead-based paint), with 95 percent confidence.

As of the publication of this edition of these *Guidelines*, a lead test kit can be EPA-recognized (see the list at <http://www.epa.gov/lead/pubs/testkit.htm>) for determining, for RRP rule use, that lead-based paint is not present if it meets EPA’s negative response criterion, above. EPA’s recognition of such kits will last until EPA publicizes its recognition of the first test kit that meets both the negative response and positive response criteria outlined in the RRP rule. (40 CFR 745.88(b)(3).) As of the publication of this edition of these *Guidelines*, EPA had recognized three lead test kits for use in complying with the false negative response criterion of the RRP rule, but no test kit that meet both its false positive and false negative criteria. Accordingly, when a certified renovator obtains a negative response from an EPA-recognized test kit, i.e., indicating that lead-based paint is not detected, the certified renovator may use the response as part of determining whether the renovation project is exempt from the RRP Rule (but this does not provide an exemption from the Lead Disclosure Rule or the Lead Safe Housing Rule, which require lead-based paint inspections to support the exemption). Similarly, when a certified inspector or risk assessor obtains a negative response from an EPA-recognized test kit – but not a positive response – the response may be mentioned in a lead-based paint inspection, hazard screen or risk assessment report.

HUD and EPA may fully recommend chemical spot test kit use at some point after the publication of this edition of these *Guidelines* for lead-based paint inspections if the technology is demonstrated to be equivalent to XRF or laboratory paint-chip analysis in its ability to properly classify painted surfaces into positive, negative, and, if appropriate, inconclusive categories, with appropriate estimates of the magnitude of sampling and analytical error. XRF Performance Characteristic Sheets currently provide such estimates for XRFs, and analytical error is

well-described for laboratory analysis. Information on test kits or other new technologies for testing for lead in paint can be obtained from the lead test kits website above, and the EPA contact listed there, and from the National Lead Information Center Clearinghouse (1-800-424-LEAD) (hearing- or speech-challenged individuals may access this number through TTY by calling the toll-free Federal Relay Service at 800-877-8339) (<http://www.epa.gov/oppt/lead/pubs/nlic.htm>).

II. Summary of XRF Radiation Safety Issues

Radiation hazards associated with the use of XRFs that use radioactive sources are covered in detail in section VII. The shutter of an XRF must never be pointed at anyone, even if the shutter is closed. Inspectors should wear radiation dosimeters to measure their exposure, although excessive exposures are highly unlikely if the instruments are used in accordance with the manufacturer's instructions. If feasible, persons should not be near the other side of a wall, floor, ceiling, or other building component surface being tested.

III. Definitions

Definitions of several key terms used in this chapter are provided here. Although other definitions are available, the definitions and descriptions in this chapter should be used when conducting lead-based paint inspections.

- a) **Building Component Types** – A building component type consists of doors, windows, walls, and so on that are repeated in more than one room equivalent in a unit and have a common substrate. If a unique building component is present in only one room, it is considered to be a testing combination. Each testing combination may be composed of more than one building component (such as two similar windows within a room equivalent). Component types can be located inside or outside the dwelling. For example, typical component types in a bedroom would be the ceiling, walls, a door and its casing, the window sash, window casings, and any other distinct surface, such as baseboards, crown molding, and chair rails. If trends or patterns of lead-based paint classifications are found among building component types in different room equivalents, an inspection report may summarize results by building component type, as long as all measurements are included in the report. For example, the inspection may find that all doors and door casings in a dwelling unit are coated with LBP (are "positive").
- b) **Lead-based paint** – As of the publication of this edition of these *Guidelines*, lead-based paint means paint or other surface coatings that contain lead equal to or greater than 1.0 mg/cm² or 0.5 percent by weight. (Equivalent units for the weight concentration are: 5,000 µg/g, 5,000 mg/kg, or 5,000 ppm by weight.) Surface coatings include paint, shellac, varnish, or any other coating, including wallpaper that covers painted surfaces.
- c) **Lead loading** – The mass of lead in a given surface area of a substrate. Lead loading is typically measured in units of milligrams per square centimeter (mg/cm²). It is also called area concentration.
- d) **Room equivalent** – A room equivalent is an identifiable part of a residence, such as a room, a house exterior, a foyer, a staircase within a housing unit, a hallway within a housing unit, or an exterior area (exterior areas contain items such as play areas, painted swing sets, painted sandboxes, etc.). Closets or other similar areas adjoining rooms should not be considered as separate room equivalents unless they are obviously dissimilar from the adjoining room equivalent. Most closets are not separate room equivalents. Exteriors should be included in all inspections. An individual side of an exterior is not considered to be a

separate room equivalent, unless there is visual or other evidence that its paint history is different from that of the other sides. All sides of a building (typically two for row houses, three for each of the units of a side-by-side duplex, or four for freestanding houses) are generally treated as a single room equivalent if the paint history appears to be similar. For multi-family developments or apartment buildings, common areas and exterior sites are treated as separate types of units, not as room equivalents (see section V.C.1 for further guidance).

- e) **Substrate** – The substrate is the material underneath the paint. Substrates should be classified into one of six types: brick, concrete, drywall, metal, plaster, or wood. These substrates cover almost all building materials that are painted and are linked to those used in the XRF Performance Characteristic Sheets (PCS). For example, the concrete substrate type includes poured concrete, precast concrete, and concrete block.

If a painted substrate is encountered that is different from the substrate categories shown on the PCS, select the substrate type that is most similar in density and composition to the substrate being tested. For example, for painted glass substrates, an inspector should select the concrete substrate, because it has about the same density (2.5 g/cm²) and because the major element in both is silicon.

For components that have layers of different substrates, such as plaster over concrete, the substrate immediately adjacent to (underneath) the painted surface should be used. For example, plaster over concrete block is recorded as plaster.

- f) **Testing Combination** – A testing combination is a unique combination of room equivalent, building component type, and substrate. Visible color may not be an accurate predictor of painting history and is not included in the definition of a testing combination. Table 7.1 lists common building component types that could make up distinct testing combinations within room equivalents. The list is not intended to be exhaustive. Unlisted components that are coated with paint, varnish, shellac, wallpaper, stain, or other coating should also be considered as a separate testing combination.

Certain building components that are adjacent to each other and not likely to have different painting histories can be grouped together into a single testing combination, as follows:

- ◆ Window casings, stops, jambs and aprons are typically a single testing combination
- ◆ Interior window mullions and window sashes are a single testing combination – do not group interior mullions and sashes with exterior mullions and sashes
- ◆ Exterior window mullions and window sashes are a single testing combination
- ◆ Door jambs, stops, transoms, casings and other door frame parts are a single testing combination
- ◆ Door stiles, rails, panels, mullions and other door parts are a single testing combination
- ◆ Baseboards and associated trim (such as quarter-round or other caps) are a single testing combination (do not group chair rails, crown molding or walls with baseboards)
- ◆ Painted electrical sockets, switches or plates can be grouped with walls

Each of these building parts should be tested separately if there is some specific reason to believe that they have a different painting history. In most cases, separate testing will not be necessary.

Table 7.1 Examples of Interior and Exterior Building Component Types

Commonly Encountered Interior Painted Components That Should Be Tested Include:		
Air Conditioners	Counter Tops	Radiators
Balustrades	Crown Molding	Shelf Supports
Baseboards	Doors and Trims	Shelves
Bathroom Vanities	Electrical Fixtures, Painted	Stair Stringers
Beams	Fireplaces	Stair Treads and Risers
Cabinets	Floors	Stools and Aprons
Ceilings	Handrails	Walls
Chair Rails	Newel Posts	Window Sashes and Trim
Columns	Other Heating Units	
Exterior Painted Components That Should Be Tested Include:		
Air Conditioners	Fascias	Railing Caps
Balustrades	Floors	Rake Boards
Bulkheads	Gutters and Downspouts	Sashes
Ceilings	Joists	Siding
Chimneys	Handrails	Soffits
Columns	Lattice Work	Stair Risers and Treads
Corner boards	Mailboxes	Stair Stringers
Doors and Trim	Painted Roofing	Window and Trim
Other Exterior Painted Components Include:		
Fences	Storage Sheds & Garages	
Laundry Line Posts	Swing sets and Other Play Equipment	

Table 7.2 provides six examples of different testing combinations. The first example is a wooden bedroom door. This is a testing combination because it is described by a room equivalent (bedroom), component (door), and substrate (wood). If one of these variables is different for another component, that component is a different testing combination. For example, if a second door in the room equivalent is metal, two testing combinations, not one, would be present.

Table 7.2 Examples of Distinct Testing Combinations

Room Equivalent	Building Component	Substrate
Master Bedroom (Room 5)	Door	Wood
Master Bedroom (Room 5)	Door	Metal
Kitchen (Room 3)	Wall	Plaster
Garage (Room 10)	Floor	Concrete
Exterior	Siding	Wood
Exterior	Swing set	Metal

Test Location – The test location is a specific area on a testing combination where either an XRF reading or a paint-chip sample will be taken. For doors separating rooms, each side of the door is assigned to the room equivalent it faces and is tested separately. The same is true of door casings. For prefabricated metal doors where it is apparent that both sides of the door have the same painting history, only one side needs to be tested.

IV. Inspections in Single-Family Housing

Single-family housing inspections should be conducted by a State- or EPA-certified (licensed) lead-based paint inspector using the following seven steps, some of which may be done at the same time:

- ◆ List all testing combinations, including those that are painted, stained, shellacked, varnished, coated, or wallpaper which covers painted surfaces.
- ◆ Select testing combinations.
- ◆ Perform XRF testing (including the calibration check readings).
- ◆ Collect and analyze paint-chip samples for testing combinations that cannot be tested with XRF, that had inconclusive XRF results, or for client-approved confirmation of XRF results.
- ◆ Classify XRF and paint-chip results.
- ◆ Evaluate the work and results to ensure the quality of the paint inspection.
- ◆ Document all findings in a plain language summary and a complete report; include language in both the summary and the report indicating that the information must be disclosed to tenants and prospective purchasers in accordance with Federal law (24 CFR part 35 or 40 CFR part 745) (see Appendix 6).

A. Listing Testing Combinations

Develop a list of all testing combinations in all interior rooms, on all exterior building surfaces, and on surfaces in other exterior areas, such as fences, playground equipment, and garages. The “Single-Family Housing LBP Testing Data Sheet” (see Addendum 2) or a comparable data collection instrument may be used for this purpose. An inventory of a house may be completed either before any testing or on a room-by-room basis during testing. HUD encourages inspectors to take the inventory before beginning any testing. This provides the inspector with an overview of the housing to be inspected, identify problems, and helps the inspector organize the inspection work activities.

1. Number of Room Equivalents to Inspect

Test all room equivalents inside and outside the dwelling unit. The final report must include a final determination of the presence or absence of lead-based paint on each testing combination in each room equivalent. For varnished, stained, or similar clear-coated floors, measurements in only one room equivalent are permissible if it appears that the floors in the other room equivalents have the same coating.

Some testing combinations have multiple parts. For example, a window testing combination could theoretically be broken down into the interior sill (stool), exterior sill, trough, sash, apron, parting bead, stop bead, casing, and so on. Because it is highly unlikely that all these parts will have different painting histories, usually they should not be considered separate testing combinations unless their professional judgment and field condition dictate otherwise. (Inspectors should regard parts of building components as separate testing combinations if they have evidence that different parts have separate, distinct painting histories). Windows and doors would typically have at least two combinations, interior and exterior. See the definition of testing combination (section III, above) for guidance on which building component parts may and may not be grouped together.

2. Number of Testing Combinations to Inspect

Inspect each testing combination in each room equivalent, unless similar building component types with identical substrates (such as windows) are all found to contain lead-based paint in the first five interior room equivalents. In that case, testing of that component type in the remaining room equivalents may be discontinued, *if and only if* the purchaser of the inspection services agrees beforehand to such a discontinuation. The inspector should then conclude that similar building component types in the rest of the dwelling unit also contain lead-based paint. For example, if an inspector finds that baseboards in the first five room equivalents are all positive, the inspector – with the client’s permission – may conclude that all remaining room equivalents in the unit contain positive baseboards. This is sometimes referred to as a “positive stop.”

Because it is highly unlikely that testing combinations *known* (and not just presumed) to have been replaced or added to the building after 1977 will contain lead-based paint, they need not be tested. If the age of the testing combination is in doubt, it should be tested.



FIGURE 7.2 Child's bed showing teeth marks in the painted surface. Paint should be tested for lead.

3. Painted Furniture

Painted furniture that is physically attached to the unit (for example, a built-in desk or dresser) should be included in the inspection as a testing combination. Other painted furniture may also be tested, depending on the client's wishes. Children's furniture (such as cribs or playpens), especially if built before 1978, may contain lead-based paint and can be tested, subject to the client's wishes (see Figure 7.2). Imported products may be more suspect, and therefore tested. Check that the entire face plate of the XRF is flush to a painted surface of the furniture. If this is not possible, the piece of furniture must be presumed to be coated with lead-based paint, or a chip may be taken for lead analysis by an EPA-recognized laboratory.

4. Ceramic Tile and Other Fixtures

Some inspectors and risk assessors test non-paint surfaces such as unpainted ceramic tile and porcelain

bathtubs for lead content because these items may be a source of lead exposure during demolition or renovation. These items are not considered lead-based paint; their presence does not need to be included in disclosure under the Lead Disclosure Rule (see Appendix 6). Lead-containing ceramic tile is not a common cause for childhood lead poisoning. However, surface abrading and demolition activities such as breaking or crushing may release lead. For this reason, some inspectors and risk assessors include ceramic tile and bathtubs in pre-rehabilitation inspections/risk assessments and reference the OSHA lead in construction standard (29 CFR 1926.62) in their reports (see Appendix 6).

Ceramic tiles are still available with lead glaze; these are being sold and installed in homes. HUD's American Healthy Homes Survey found some tiles with lead loadings of 1.0 mg/cm² or more in homes built after 1977. (HUD, 2011)

5. Building Component Types

Results of an inspection may be summarized by classifying component types across room equivalents if patterns or trends are supported by the data.

6. Substrates

Several types of XRF instruments do not require "substrate correction," needed to correct a systematic bias in an XRF instrument resulting from interference from substrate material beneath the paint. (See Section IV.E, below.) However, all substrates across all room equivalents should be grouped into one of the six substrate categories (brick, concrete, drywall, metal, plaster, or wood) shown on the XRF Performance Characteristic Sheet for the instrument being used. Substrate correction procedures, if required, can then be applied for all building component types with the same substrate. For example, the substrate correction procedure for wooden doors and wooden baseboards can use the same substrate correction value.

B. Number and Location of XRF Readings

1. Number of XRF Readings for Each Testing Combination

XRF testing is required for at least one location per testing combination, except for interior and exterior walls, where four readings should be taken, one on each wall. Analysis (Westat, 1996) of EPA data show a median difference in spatial variation of only 0.1 mg/cm² and a change in classification (positive, negative, or inconclusive) occurs less than 5 percent of the time as a result of different test locations on the same testing combination. (Westat, 1996) Multiple readings on the same testing combination or testing location are, therefore, unnecessary, except for interior and exterior walls.

Because of the large surface areas and quantities of paint involved, and the possibility of increased spatial variation, take at least four readings (one reading on each wall) in each room equivalent. (For room equivalents with fewer than four walls, test each wall.) For each set of walls with the same painting history in a room equivalent, test the four largest walls. Classify each wall based on its individual XRF reading. If a room equivalent has more than four walls, calculate the average of the readings, round the result to the same number of decimal places as the XRF instrument displays, and classify the remaining walls with the same painting history as the tested walls, based on this rounded average. When the remaining walls in a room equivalent clearly do not have the same painting history as that of the tested walls, test and classify the remaining walls individually. For exterior walls, select at least four sides and average the readings (rounding the result as described above) to obtain a result for any remaining sides. If there are more than four walls and the results of the tested walls do not follow a classification pattern (for example, one is positive and the other three are negative), test each wall individually.

2. Location of XRF Readings

The selection of the test location for a specific testing combination should be representative of the paint over the areas that are most likely to be coated with old paint or other lead-based coatings. Thus, locations where the paint appears to be thickest should be selected. Locations where paint has worn away or been scraped off should not be selected. Areas over pipes, electrical surfaces, nails, and other possible interferences should also be avoided if possible. All layers of paint should be included and the XRF probe faceplate should be able to lie flat against the surface of the test location.

If no acceptable location for XRF testing exists for a given testing combination, a paint-chip sample should be collected and sent to a lead laboratory recognized by NLLAP for analysis of lead in paint. The sample should include all paint layers and should be taken as unobtrusively as possible. Because paint-chip sampling is destructive, a single sample may be collected from a wall and used to characterize the other walls in a room equivalent (see section VI for additional details on paint-chip sampling). For greater reliability, consider collection and analysis of more than one sample.

3. Documentation of XRF Reading Locations

Descriptions of testing combinations must be sufficiently detailed to permit another individual to find them. While it is not necessary to document the exact spot or the exact building

component on which the reading was taken, it is necessary to record the exact testing combination measured. Current room uses or colors can change and should not be the only way of identifying them. A numbering system, floor plan, sketch or other system may be used to document which testing combinations were tested. While HUD does not require a standard identification system, one that could be used is as follows:

a) **Side identification**

Identify perimeter wall sides with letters A, B, C, and D (or numbers or Roman numerals). Side A for single-family housing is the street side for the address. Side A in multi-family housing is the apartment entry door side.

Side B, C, and D are identified clockwise from Side A as one faces the dwelling; thus Wall B is to the left, Wall C is across from Side A, and Side D is to the right of Side A.

Each room equivalent's side identification follows the scheme for the whole housing unit. Because a room can have two or more entries, sides should not be allocated based on the entry point. For example, giving a closet a side allocation based on how the room is entered would make it difficult for another person to make an easy identification, especially if the room had two closets and two entryways.

b) **Room Equivalent Identification**

Room equivalents should be identified by both a number and a use pattern (for example, Room 5-Kitchen). Room 1 can always be the first room, at the A-D junction at the entryway, or it can be the exterior. Rooms are consecutively numbered clockwise. If multiple closets exist, they are given the side allocation: for example, Room 3, Side C Closet. The exterior is always assigned a separate room equivalent identifier.

c) **Sides in a Room**

Sides in an interior room equivalent follow the overall housing unit side allocation. Therefore, when standing in any four-sided room facing Side C, the room's Side A will always be to the rear, Side B will be to the left, and Side D will be to the right.

d) **Building Component Identification**

Individual building components are first identified by their room number and side allocation (for example, the radiator in Room 1, Side B is easily identified). If multiple similar component types are in a room (for example, three windows), they are differentiated from each other by side allocation. If multiple components are on the same wall side, they are differentiated by being numbered left to right when facing the components. For example, three windows on Wall D are identified as windows D1, D2, and D3, left to right. If window D3 has the only old original sash, it is considered a separate testing combination from the other two windows. Codes or abbreviations for building components and/or locations may be used in order to shorten the time needed for data entry. If codes or abbreviations are used, the inspection records and the inspection report must include a table showing their meaning.

A sketch of the dwelling unit's floor plan is often helpful, but is not required by this protocol. Whatever documentation is used, a description of the room equivalent and testing combination identification system must be included in the final inspection report.

C. XRF Instrument Reading Time

The recommended time to open an XRF instrument's shutter to obtain a single XRF result for a testing location depends on the specific XRF instrument model and the mode in which the instrument is operating. The *XRF Performance Characteristic Sheet* provides information on this issue.

To ensure that a constant amount of radiation is delivered to the painted surface, the open-shutter time that permits radiation from the radioactive source to strike the painted surface and then stimulate fluorescence in the paint that reaches the instrument's detector must be increased as the source ages and the source weakens. Almost all commercially available XRF instruments automatically adjust for the age of the source. (Some instruments adjust for source decay in some but not all modes; operators should check with the manufacturers of their instruments to determine whether these differences need to be accommodated). The following formula should be employed for instruments that use radioactive sources and that requiring manual adjustment of the open-shutter time:

$$\text{Open-Shutter Time} = 2^{(\text{Age}/\text{Half-life})} \times \text{Nominal Time}$$

where:

- ◆ Age is the age (in days) of the radioactive source, starting from the date the manufacturer says the source had its full radiation strength;
- ◆ *Half-life* is the time (in days) it takes for the radioactive material's activity to decrease to one-half its initial level; and
- ◆ *Nominal Time* is the recommended nominal number of seconds for open-shutter time to expose the surface to the X-rays from the radioactive source, when the source is at its full radiation strength, and is obtained from the *XRF Performance Characteristic Sheet*.

For example, if the age of the radioactive source is equal to its half-life (the length of time in which the number of radioactive atoms is reduced to one half of the current number of radioactive atoms), the open-shutter time should be twice the nominal time in order to get the same amount of exposure to the radiation from the decaying source. XRFs that use radioactive sources typically use cobalt-57 (with a half life of 270 days) or cadmium-109 (with a half life of 464 days). Thus, if the recommended nominal time for a particular model of XRF instrument is 15 seconds on the date of manufacture of the source, the open-shutter time should be doubled to 30 seconds 270 days later for cobalt sources and 464 days later for cadmium sources. This would be repeated at the same half-life intervals for each source as it decays further. For example, at 540 days (i.e., two half-lives) after manufacture of an XRF instrument of this model if it has a cobalt source should have its open-shutter time be 60 seconds (i.e., two times two, or four times the nominal time), at 810 days (i.e., three half-lives), 120 seconds (i.e., two multiplied by itself three times, that is, eight times the nominal time), and so on.

XRF Performance Characteristic Sheets (PCS) typically report different inconclusive ranges or thresholds (see section IV.G, below) for different nominal times and different substrates. This may affect the number of paint-chip samples that must be collected as well as the length of time required for the inspection. Some XRF devices have different modes of operation with different nominal reading times. Inspectors must use the appropriate inconclusive ranges and other criteria specified on the PCS for each XRF model, mode of operation and substrate. For example, inconclusive ranges specified for a 30-second nominal reading cannot be used for a 5-second nominal reading, even for the same instrument and the same substrate.

Inspectors should record the source age (or the date the manufacturer says the source had its full radiation strength) in the field notes for the inspection. Optionally, the inspector may include this information in description of the XRF testing method in the inspection report.

D. XRF Calibration Check Readings

In addition to the manufacturer's recommended warm up and quality control procedures, the XRF operator should take the quality control readings recommended below, unless these are less stringent than the manufacturer's instructions. Quality control for XRF instruments involves readings to check calibration. Most XRFs cannot be calibrated on-site; actual calibration can only be accomplished in the factory. You should also review ASTM E21 1900, Standard Practice for Quality Systems for Conducting in Situ Measurements of Lead Content in Paint or Other Coatings Using Field-Portable X-Ray Fluorescence (XRF) Devices.

1. Frequency and Number of Calibration Checks

For each XRF instrument, two sets of XRF calibration check readings are recommended at least every 4 hours. The first is a set of three nominal-time XRF calibration check readings to be taken before the inspection begins. The second occurs either after the day's inspection work has been completed, or at least every 4 hours, whichever occurs first. To reduce the amount of data that would be lost if the instrument were to go out of calibration between checks, and/or if the manufacturer recommends more frequent calibration checks, the calibration check can be repeated more frequently than every 4 hours. If the XRF manufacturer recommends more frequent calibration checks, the manufacturer's instructions should be followed. Calibration should also be checked before the XRF is turned off (for example, to replace a battery or before a lunch break) and after it is turned on again. For example, if an inspection of a large house took 6 hours, there would be three calibration checks: one at the beginning of the inspection, another after 4 hours, and a third at the end of the inspection.

If the XRF is not turned off as the inspector travels from one dwelling unit to the next, calibration checks do not need to be done after each dwelling unit is completed. For example, in multi-family housing, calibration checks do not need to be done after each dwelling unit is inspected; once every 4 hours is usually adequate. Some inspectors do a calibration check between units for two reasons: first, if the instrument goes out of calibration during the inspection of the unit, only that unit needs to be reinspected, and, second, if the inspector inadvertently misses a calibration check, the period between checks is less likely to exceed 4 hours.

Some instruments automatically enter a "sleep" or "off" state when not being used continually to prolong battery life. It is not necessary to perform a calibration check before and after each "sleep" state episode, unless the manufacturer recommends otherwise.

2. Calibration Check Standard Materials

Portable XRF calibration check readings are taken on the National Institute of Standards and Technology (NIST) Standard Reference Material (SRM) or NIST Certified Reference Material using the nominal 1.0 mg/cm² paint film (or nearly 1.0 in older sets) within the SRM. The complete set of paint films can be obtained by calling (301) 975-2200 or using the NIST SRM site at <http://www.nist.gov>.

nist.gov/srm/index.cfm . As of the publication of this edition of these *Guidelines*, the SRM for *Lead Paint Films for Portable XRF Analyzers* is a set of paint films numbered SRM 2579a, its cost was \$397. (At some point, this SRM may be depleted and NIST may begin selling another SRM in its place; its number (possibly 2579b) may be found by searching the NIST SRM site for “Lead Paint Films,” or asking NIST staff for an SRM for Lead Paint Films)

Calibration checks should be taken through the SRM paint film with the film positioned at least 1 foot (0.3 meters) away from any potential source of lead. The NIST SRM film should not be placed on a tool box, suitcase, or surface coated with paint, shellac, or any other coating to take calibration check readings. Rather, the NIST SRM film should be attached to a solid (not plywood) wooden board or other non-metal rigid substrate such as drywall, or attached directly to the XRF probe. The SRM should be positioned so that readings of it are taken when it is more than 1 foot (0.3 meters) away from a potential source of error. For example, the NIST SRM film can be placed on top of a 1 foot (0.3 meter) thick piece of Styrofoam or other lead-free material, as recommended by the manufacturer before taking readings.

3. Recording and Interpreting Calibration Check Readings

Each time calibration check readings are made, three readings should be taken. These readings should be taken using the nominal time which will be used during the inspection, selected from among those specified in the PCS. The open shutter time should be adjusted, if necessary, to reflect the age of the radioactive source (see section IV.C, above). The readings can be recorded on the “Calibration Check Test Results” form (Form 7.2 in Addendum 2), on a comparable form, or stored in the instrument’s memory, and printed out or transferred to a computer later. The average of the three calibration check readings should be calculated, rounded to the same number of decimal places as the XRF instrument displays, and recorded on the form.

Large deviations from the NIST SRM value will alert the inspector to problems in the instrument’s performance. If the observed calibration check average is outside of the acceptable calibration check tolerance range specified in the instrument’s PCS, the manufacturer’s instructions should be followed to bring the instrument back into control. A successful calibration check should be obtained before additional XRF testing is conducted. Readings not accompanied by successful calibration checks at the beginning and end of the testing period are unreliable and should be repeated after a successful calibration check has been made. If a backup XRF instrument is used as a replacement, it must successfully pass the initial calibration check test before retesting the affected test locations. (Current sheets are available at www.hud.gov/offices/lead/lbp/hudguidelines/allpcs.pdf.)

This procedure assumes that the HUD/EPA lead-based paint standard of 1.0 mg/cm² is being used. If a different standard is being used, other NIST SRMs should be used to determine instrument performance against the different standard (see Section IV D 2). At the time of the publication of this edition of these *Guidelines*, however, no method for determining XRF performance characteristics using different standards has been developed.

E. Substrate Correction

XRF readings are sometimes subject to systematic biases as a result of interference from substrate material beneath the paint. The magnitude and direction of bias depends on the substrate, the specific XRF instrument being used, and other factors such as temperature and humidity. Results

can be biased in either the positive or negative direction and may be quite high.

1. When Substrate Correction Is Not Required

Some XRF instruments do not need to have their readings corrected for substrate bias on any substrate. Other instruments may only need to apply substrate correction procedures on specific substrates and/or when XRF results are below a specific value. The *XRF Performance Characteristic Sheet* should be consulted to determine the requirements for a specific instrument and each mode of operation (e.g., nominal time, or time required for intended precision). XRF instruments which do not require correction for any substrate, or require corrections on only a few substrates, have an advantage in that they simplify and shorten the inspection process.

2. Substrate Correction Procedure

XRF results are corrected for substrate bias by subtracting a correction value determined separately in each house for each type of substrate where lead paint values are in the substrate correction range indicated on the XRF Performance Characteristic Sheet (PCS). In single-family housing, the substrate correction value is determined using the specific instrument(s) used in that house. The correction value (formerly called "Substrate Equivalent Lead" or "SEL") is an average of six XRF readings, with three taken from each of two test locations that have been scraped visually clean of their paint coating. The locations selected for removal of paint should have an initial XRF reading on the painted surface of less than 2.5 mg/cm², if possible. If all initial readings on a substrate type are greater than 2.5 mg/cm², the locations with the lowest initial reading should be chosen. Because available data indicate that surfaces with XRF readings in excess of about 3.0 mg/cm² or 4.0 mg/cm² are almost always coated with lead-based paint, and since bleed-through of lead into the substrate may occur, or pipes and similarly interfering building components may be behind the material being evaluated, locations with such high readings should be avoided for substrate correction.

After all XRF testing has been completed but before the final calibration check test has been conducted, XRF results for each substrate type should be reviewed. If any readings fall within the range for substrate correction for a particular substrate, obtain the substrate correction value.

On each selected substrate requiring correction, two different testing combinations must be chosen for paint removal and testing. For example, if the readings are inconclusive for some wooden baseboards, select two baseboards, each from a different room. If some wooden doors also require substrate correction, the inspector should take substrate correction readings on one door and one baseboard. Selecting the precise location of substrate correction should be based on the inspector's ability to remove paint thoroughly from the substrates, the similarity of the substrates, and their accessibility. The XRF probe faceplate must be able to be placed over the scraped area, which should be completely free of paint or other coatings.

The size of the area from which paint is taken depends on the size of the analytical area of the XRF probe faceplate; normally, the area is specified by the manufacturer. To ensure that no paint is included in the bare substrate measurement, the bare area on the substrate should be slightly larger than the analytical area on the XRF probe faceplate.

In all, six readings must be taken for each substrate type that requires correction. All six must be averaged together. Take three readings on the first *bare* substrate area. Record

the substrate and XRF readings on the "Substrate Correction Values" form (Form 7.3 in Addendum 2) or a comparable form. Repeat this procedure for the second bare substrate area and record the three readings on the same form. Substrate correction values should be determined using the same instrument used to take readings on the painted surfaces. If more than one XRF model was used to take readings, apply the substrate correction values as specified on each instrument's PCS.

Compute the correction value for each substrate type that requires correction by computing the average of all six readings as shown below and recording the results on the "Substrate Correction Values" form. The formula given below should be used to compute the substrate bias correction value for XRF readings taken on a bare substrate that is not covered with NIST SRM film. A different formula should be used when SRM film must be placed over the bare substrate. The PCS specifies when this correction is necessary and provides the formula for computing the correction value.

For each substrate type requiring substrate correction, transfer the correction values to the "Single-Family Housing LBP Testing Data Sheet" (Form 7.1). Correct XRF readings for substrate interference by subtracting the correction value from each XRF reading.

Example: Suppose that a house has 50 testing combinations with wood substrates. The PCS states that a correction value for XRF results taken on those wood testing combinations that have values less than 4.0 mg/cm² must be computed. Select two test locations from the testing combinations that had uncorrected XRF results of less than 2.5 mg/cm². Completely remove the paint from these two test locations and take three nominal-time XRF readings on the bare substrate at each location. The six XRF readings at the two random locations are:

Master Bedroom Wood Door (mg/cm ²)			Kitchen Wood Baseboard (Room 4) (mg/cm ²)		
First	Second	Third	First	Second	Third
1.32	0.91	1.14	1.21	1.03	1.43

The correction value is the average of the six values:

$$\text{Correction value} = (1.32 + 0.91 + 1.14 + 1.21 + 1.03 + 1.43) \text{ mg/cm}^2 / 6 = 1.17 \text{ mg/cm}^2$$

In this same house, three different wood testing combinations were inspected for lead-based paint and the XRF results are: 1.63 mg/cm², 3.19 mg/cm², and 1.14 mg/cm². Correcting these three XRF measurements for substrate bias produce the following results:

$$\text{First corrected measurement} = 1.63 \text{ mg/cm}^2 - 1.17 \text{ mg/cm}^2 = 0.46 \text{ mg/cm}^2$$

$$\text{Second corrected measurement} = 3.19 \text{ mg/cm}^2 - 1.17 \text{ mg/cm}^2 = 2.02 \text{ mg/cm}^2$$

$$\text{Third corrected measurement} = 1.14 \text{ mg/cm}^2 - 1.17 \text{ mg/cm}^2 = -0.03 \text{ mg/cm}^2$$

The third corrected result shown above is an example of how random error in XRF measurements can cause the corrected result to be less than zero. (Random measurement error is present whenever measurements are taken). Note that correction values can be either positive or negative. In short, negative corrected XRF values should be reported if supported by the data.

Finally, suppose an XRF result of 1.24 mg/cm² has a correction value of negative 0.41 mg/cm². Subtracting a negative number is the same as adding its positive value. Therefore, the corrected measurement would be:

$$\text{Corrected result} = 1.24 \text{ mg/cm}^2 - (-0.41 \text{ mg/cm}^2) = 1.24 \text{ mg/cm}^2 + 0.41 \text{ mg/cm}^2 = 1.65 \text{ mg/cm}^2$$

3. Negative Values

If more than 20 percent of the corrected values are negative, the instrument's lead paint readings and/or the substrate readings are probably in error. Calibration should be checked and substrate measurements should be repeated.

F. Discarding Readings

If the manufacturer's instructions call for the deletion of readings at specific times, *only* readings taken at those specific times should be deleted. Similarly, readings between a successful calibration check and a subsequent unsuccessful calibration check must be discarded. Readings should not be deleted based on any criteria other than what is specified by the manufacturer's instructions or the *HUD Guidelines*. For example, a manufacturer may instruct operators to discard the first XRF reading after a substrate change. If so, *only* the first reading should be discarded after a substrate change.

G. Classification of XRF Results

XRF results are classified as positive, negative, or inconclusive.

A *positive* classification indicates that lead is present on the testing combination at or above the HUD/EPA standard; as of the publication of this edition of these *Guidelines*, the standard is 1.0 mg/cm². A positive XRF result is any value greater than the upper bound of the inconclusive range, or greater than or equal to the threshold, as specified on the applicable XRF Performance Characteristic Sheet (PCS).

A *negative* classification indicates that lead is not present on the testing combination at or above the HUD/EPA standard. A negative XRF result is any value less than the lower bound of the inconclusive range, or less than the threshold, specified on the PCS.

An *inconclusive* classification indicates that the XRF cannot determine with reasonable certainty whether lead is present on the testing combination at or above the HUD/EPA standard. An inconclusive XRF result is any value falling within the inconclusive range on the PCS (including the boundary values defining the range). In single-family housing, all inconclusive results should be confirmed by analysis by a laboratory recognized by EPA, under NLLAP, for analysis of lead in paint, unless the client wishes to assume that all inconclusive results are positive.

Positive, negative, and inconclusive results apply to the actual testing combination and to any repetitions of the testing combination that were not tested in the room equivalents. Positive results also apply to similar component types in room equivalents that were not tested. For example, suppose that one baseboard in a room equivalent is tested, and that the inspector decided that all four baseboards are a single testing combination. The single XRF result applies to all four baseboards in that room equivalent.

When an inconclusive range is specified on the PCS, the inconclusive range includes its upper and lower bounds. XRF results are classified as positive if they are greater than the upper boundary of the inconclusive range, negative if they are less than the lower boundary of the inconclusive range, or inconclusive otherwise. For example (as in the table below), if the inconclusive range is 0.51 mg/

cm² to 1.49 mg/cm², an XRF result of 0.50 mg/cm² is considered negative, because it is less than 0.51; a result of 0.6 mg/cm² is inconclusive; and a result of 1.5 mg/cm² is positive. Results of 0.51 mg/cm², 1.00 mg/cm², or 1.49 mg/cm² would be inconclusive. If the instrument reads to only one decimal place (such as 0.5 mg/cm²), the reading is treated as having a 0 in the second decimal place (as if the reading were 0.50 mg/cm²) for classifying the result with respect to its inconclusive range.

Reading (mg/cm ²)	Inconclusive Range in PCS		Classification
	Lower limit (mg/cm ²)	Upper limit (mg/cm ²)	
0.50	Below lower limit		Negative
0.51	At lower limit		Inconclusive
0.60	Above lower limit	Below upper limit	Inconclusive
1.00	Above lower limit	Below upper limit	Inconclusive
1.49		At upper limit	Inconclusive
1.50		Above upper limit	Positive

Different XRF models have different inconclusive ranges, depending on the specific XRF model and the mode of operation. The inconclusive range may also be substrate-specific.

In some cases, the upper and lower limits of the inconclusive range are equal; that value is called the *threshold*. If the reading is less than the threshold, then the reading is considered negative. If the reading is equal to or greater than the threshold, then the reading is considered positive.

Use of the inconclusive range and threshold is detailed in the performance characteristic sheet. The categories include substrate-corrected results, if substrate correction is indicated. XRFs with *only* threshold values listed on the PCS are advantageous in that classifications of results are either positive or negative (no XRF readings are inconclusive).

Note that the final inspection report should **not** list inconclusive readings as a third category in addition to positive and negative. There are two options for addressing inconclusive readings:

- ◆ A paint chip may be sampled and sent to a laboratory recognized by EPA, under NLLAP, for analysis of lead in paint.
- ◆ If the client agrees, all inconclusive readings may be assumed to be positive. It is not permissible to assume any inconclusive reading is negative.

H. Evaluation of the Quality of the Inspection

The person responsible for purchasing inspection services – the homeowner, property owner, housing authority, prospective buyer, occupant, contractor, etc.; also known as the client – should consider evaluating the quality of the work using one or more of the methods listed below. Evaluation methods include direct observation, immediate provision of results, repeated testing, and time-and-motion analysis. Direct observation of the inspection should be used whenever possible. If this quality evaluation is to be conducted, the inspection contract should outline the financial penalties that will occur

if an inspector fails to perform as contracted during any visit. The certified lead-based paint inspection firm remains responsible, of course, for performing the inspection properly, even when the client, or a representative, has evaluated the quality of the work.

1. Direct Observation

An evaluation of a lead-based paint inspection is best made if a knowledgeable observer is present for as much of the XRF testing as possible. This is the only way to ensure that all painted, varnished, shellacked, wallpapered, stained, or other coated testing combinations are actually tested, and that all XRF readings are recorded correctly. Employ as the observer someone who is trained in lead-based paint inspection and who is independent of the inspection firm.

If it is not feasible for the client or the client's representative to be present throughout the inspection, that person should conduct unannounced and unpredictable visits to observe the inspection process. The number of unannounced visits will depend on the results of prior visits. When observing ongoing XRF testing, review the test results for the room equivalent currently being tested and for the previously inspected room equivalent. Even if the first visit is fully satisfactory, follow-up visits should be conducted throughout the inspection.

2. Immediate Provision of Results

The client, or a representative, should ask the inspector to provide copies or printouts of results on completed data forms immediately following the completion of the inspection or on a daily basis. Alternatively, the client, or a representative, should visually review the inspector's written results to ensure that they are properly recorded for all surfaces that require XRF testing. If surfaces have been overlooked or recorded incorrectly, the inspection process should be stopped and considered deficient. Clients should retain daily results to ensure that the data in the final report are the same as the data collected in the home.

3. Repeated Testing of 10 Surfaces

Data from HUD's private housing lead-based paint hazard control program show that it is possible to successfully retest painted surfaces without knowing the exact spot which was tested.

Select 10 testing combinations at random from the already compiled list in the "Single-Family Housing LBP Testing Data Sheet" for retesting (see forms in Addendum 2 of this chapter). Observe the inspector during the retesting. If possible, the same XRF instrument used in the original inspection should be used in the retesting. If the XRF instrument used in the original inspection is not available and cannot be returned to the site, use an XRF of the same model for retesting. Use the same procedures to retest the 10 testing combinations. The 10 repeat XRF results should be compared with the 10 XRF results previously made on the same testing combinations.

The repeat readings and the original readings should not be corrected for substrate bias for the purpose of this comparison. The average of the 10 repeat XRF results should not differ from the 10 original XRF results by more than the retest tolerance limit. The procedure for calculating the retest tolerance limit is specified in the PCS. If the limit is exceeded, the procedure should be repeated using 10 different testing combinations. If the retest tolerance limit is exceeded again, the original inspection is considered deficient.

4. Time-and-Motion Analysis

Anyone who contracts for a lead-based paint inspection can also perform a simple check to determine if the inspector had sufficient time to complete the number of housing units reported as being tested in the time allotted. Usually, inspections require at least 1 to 2 hours per housing unit using technology in common use at the time of publication of these *Guidelines*, with the number of rooms and the complexity of the surfaces among the factors that affect the inspection duration. A one-bedroom apartment may require considerably less time. If the inspector's on-site time is significantly less than the expected duration, the situation should be looked into further to determine if the inspector actually completed the work described in the report.

I. Documentation in Single-Family Housing

1. Data Forms

Data can be recorded on handwritten forms, electronically, or by a combination of these two methods. XRF readings can be entered on handwritten forms, such as the set of forms provided in Addendum 2 – Data Collection Forms (or comparable forms). Because handwriting and keyboard entry can result in transcription errors, handwritten and keyboard-entered forms should be examined for missing data and copying errors.

2. Electronic Data Storage

Electronic data storage is recommended only if the data recorded are sufficient to allow another person to find the testing combination that corresponds to each XRF reading. Electronically stored data should be printed in hard copy either daily or at the completion of the inspection, unless the inspector (or the inspection firm) has an electronic data archiving procedure in place. The data should be examined for extraneous symbols, extra data, and missing data, including missing test location identification. In most cases, electronic data storage is supplemented by manual data recording of sampling location, operator name, and other information, although some XRF instruments allow at least some of this supplemental information to be stored on the instrument.

3. Final Report

The final report must include both a summary and complete information about the site, the inspector, the inspection firm, the inspection process, and the inspection results. Report writing is an important element of completing lead-based paint inspections. The professional responsibilities of an inspector include writing reports that are well-written, understandable, and meet EPA requirements. Clients, such as owners, are encouraged to request report revisions for clarity and regulatory compliance.

The full report should include a complete data set, including:

- ◆ Date of each inspection.

- ◆ Address of building.
- ◆ Date of construction.
- ◆ Apartment numbers (if applicable).
- ◆ Name, address, and telephone number of the owner or owners of each residential dwelling or child-occupied facility.
- ◆ Name, signature, and certification number of each certified inspector and/or risk assessor conducting testing.
- ◆ Name, address, and telephone number of the certified firm employing each inspector and/or risk assessor, if applicable.
- ◆ Each testing method and device and/or sampling procedure employed for paint analysis, including quality control data and, if used, the serial number of any x-ray fluorescence (XRF) device.
 - It is typical to include the name of the instrument manufacturer and model number, as well.
- ◆ Specific locations of each painted component tested for the presence of lead-based paint.
 - It may be helpful to provide the numbering system or sketches that identify building components and room equivalents.
- ◆ The results of the inspection expressed in terms appropriate to the sampling method used.
 - The report should start with a plain-language summary of the results of the inspection.
 - ◆ As part of its overview of the results of the inspection, the summary should answer two questions:
 - Is there lead-based paint in the house?
 - If lead-based paint is present, where is it located?
 - The report should include the final classification of all testing combinations into positive or negative categories, including a list of testing combinations, or building component types and their substrates, which were classified but not individually tested (see below).
 - It is typical to include tables or listings of all XRF readings (including calibration check readings), and of the results of any paint-chip analyses that were performed (including the name, address, telephone number and NLLAP recognition number of the laboratory(ies) that conducted the analyses). If codes or abbreviations for building components and/or locations have been used in order to shorten the time needed for data entry, the inspection report must include a table showing their meaning.

As noted above, the final report should **not** list inconclusive readings as a third category in addition to positive and negative. The report should include the actual readings for any testing combinations for which readings were inconclusive, and were classified as positive by assumption, **or** which, after the XRF testing, were analyzed by a laboratory recognized by EPA, under NLLAP, for analysis of lead in paint, and what the results of that analysis were, including the paint level and whether or not it is lead-based paint.

Note that final classifications are needed for building component types and their substrates that were not actually tested in the single-family property. For example, if the client wants to suspend testing on testing combinations that were found to be positive in the first five room equivalents and are assumed to be positive in the remaining rooms, the final report should list those testing combinations that are assumed to be positive.

The summary should also contain language regarding disclosure, such as one of the following blocks of text, based on whether lead-based paint was found or was not found, respectively:

Recommended Report Language On Disclosure Where Lead-Based Paint Was Identified in Target Housing

Results of this inspection must be provided to new lessees (tenants) and prospective buyers of this property under Federal law (24 CFR part 35 and 40 CFR part 745) before they become obligated under a lease or sales contract. The complete report must be provided by the owner to prospective buyers and it must be made available to prospective tenants, and to renewing tenants if they have not been provided the information previously. The inspector's plain language summary of the report must be provided to the client (e.g., property owner or manager) when the complete report is provided. The landlord (lessor) or seller is also required to distribute an educational pamphlet approved by the U.S. Environmental Protection Agency and include the Lead Warning Statement in the leases or sales contracts to ensure that parents have the information they need to protect their children from lead-based paint hazards. Complete disclosure requires the landlord/sellers and renters/buyers (and their agents) to sign and date acknowledgement that the required information and materials were provided and received. Also, prospective buyers must be provided the opportunity to have their own lead-based paint inspection, lead hazard screen or risk assessment performed before the purchase agreement is signed; the standard period is 10 days, but this period may be changed or waived by agreement between the seller and prospective buyer. EPA regulations require the inspector to keep the inspection report for at least 3 years.

(See section IV of chapter 7 of the HUD *Guidelines for the Evaluation and Control of Lead-Based Paint Hazards in Housing* for further details; see www.hud.gov/lead.)

Recommended Report Language For Disclosure Where No Lead-Based Paint Was Identified in Target Housing

The results of this inspection indicate that no lead in amounts greater than or equal to 1.0 mg/cm² in paint was found on any building components, using the inspection protocol in chapter 7 of the *HUD Guidelines for the Evaluation and Control of Lead-Based Paint Hazards in Housing (current Revision as of the date of the inspection)*. However, some painted surfaces may contain levels of lead below 1.0 mg/cm², which could create lead dust or lead-contaminated soil hazards if the paint is turned into dust by abrasion, scraping, or sanding. This report should be kept by the inspector and the owner, and all future owners for the life of the dwelling. EPA regulations require the inspector to keep the inspection report for at least 3 years.

Sales: Disclosure is required when selling this dwelling. The complete report must be provided by the owner (seller) to prospective buyers. The inspector's plain language summary of the report must be provided to the client (e.g., property owner or manager) when the complete report is provided. The seller is required to distribute the report, an educational pamphlet approved by the U.S. Environmental Protection Agency, and include the Lead Warning Statement in the sales contract to ensure that parents have the information they need to protect their children from lead-based paint hazards. Complete disclosure requires the seller (and any agents) to sign and date acknowledgement that the required information and materials were provided and received. Furthermore, prospective buyers must be provided the opportunity to have their own lead-based paint inspection, lead hazard screen and/or risk assessment performed before the purchase agreement is signed; the standard period is 10 days, but this period may be changed or waived by agreement between the seller and prospective buyer.

Leases: This dwelling qualifies for the exemption in 24 CFR part 35 and 40 CFR part 745 for target housing being *leased* that is free of lead-based paint, as defined in the rule. No disclosure is required when renewing a lease or leasing this dwelling to new tenants.

(See section IV of chapter 7 of the *HUD Guidelines for the Evaluation and Control of Lead-Based Paint Hazards in Housing* for further details; see www.hud.gov/lead.)

Detailed documentation of the XRF testing should also be provided in the full report, including the raw data upon which it was based. The single-family housing forms provided at the end of this chapter or comparable forms would serve this purpose.

For a leased home, where no lead-based paint is identified during an inspection, the building owner is exempt from the requirements of the disclosure rule. However, when a housing unit with no lead-based paint is being sold, the owner still has responsibilities under the Disclosure Rule (e.g., providing a lead hazard information pamphlet to potential buyers), so owners should take measures to ensure the preservation and availability of the reports for the life of the building. For

leasing properties where no lead-based paint is identified, it is strongly recommended that owners retain inspection reports for the life of the building, in order to prove that leases in the building are exempt from the disclosure rule. Owners may wish to make arrangements with inspectors to store their copy of the report for longer than the 3 years required of the inspector (40 CFR 745.227(i); this also applies to risk assessment reports). (See Appendix 6 for more information on the Disclosure Rule.)

V. Inspections in Multi-family Housing

This section emphasizes the additional considerations for random sampling of large housing buildings or projects. The protocols mentioned in earlier sections are not repeated here. It will be necessary to read section IV on single-family housing to implement the protocol for multi-family housing.

Use of the multi-family protocol is less time-consuming and more cost effective than inspecting all units in a given housing development or building because in most instances a pattern can be determined after inspecting a fraction of the units. The number of units tested is based on the date of construction and the number of units in the housing development.

- ◆ For purposes of this chapter only, multi-family housing is defined as any group of more than four units that are similar in construction from unit to unit.

A. Statistical Confidence in Dwelling Unit Sampling

The number of similar units, similar common areas or exterior sites to be tested (the sample size) is based on the total number units, similar common areas or exterior sites in the building(s), as specified in Table 7.3. Use the table for sampling each set of similar units, each set of similar common areas, and each set of exterior sites, separately (that is, do *not* add the number of units, common areas and exterior sites, and then use the table for the total). For pre-1960 or unknown-age buildings or developments with 1,040 or more similar units, similar common areas or exterior sites, test 5.8 percent of them, and round up any fraction to the next whole number. For 1960-77 buildings or developments with 1,000 or more units, test 2.9 percent of the units, and round up any fraction to the next whole number. For reference, the table shows entries from 1500 to 4000 in steps of 500. For example, in a development built in 1962, with 200 similar units, 20 similar common areas, and 9 similar exterior sites, sample 27 units, 16 common areas, and all 9 exterior sites.

If lead levels in *all* units, common areas or exterior sites tested are found to be below the 1.0 mg/cm² standard, these sample sizes provide 95 percent confidence that:

- ◆ For pre-1960 housing units, less than 5 percent or fewer than 50 (whichever is less) units, common areas or exterior sites, have lead at or above the standard; and
- ◆ For 1960 to 1977 housing units, less than 10 percent or fewer than 50 (whichever is less) units, common areas or exterior sites, have lead at or above the standard.

The National Survey of Lead and Allergens in Housing (<http://www.hud.gov/offices/lead/researchers.cfm>) showed that there are fewer lead paint hazards in 1960-1977 housing than in older housing (Jacobs et al., 2002). A higher margin of error was allowed for 1960-1977 housing units to focus resources on housing with the greatest hazards. Refer to Appendix 12 of these *Guidelines* for the statistical calculations for this table. The Appendix shows the details of the calculation for pre-1960-1977 housing, which are the same for 1960-1977 housing except for using the 10 percent criterion rather than the 5 percent criterion used for older housing.

Although the data set used to develop sample sizes in multi-family housing was not randomly selected from all multi-family housing developments in the nation (no such data set is available), analyses drawn from the data are likely to err on the side of safety and public health for at least two reasons: First, the prevalence and amounts of lead-based paint are highest in pre-1960 housing developments. The sampling approach used here focuses inspection efforts on buildings where a greater chance of lead-based paint hazards exist.

The statistical rationale and calculations used to develop sample sizes in multi-family housing is based on a data set which contains approximately 164,000 XRF readings from 23,000 room equivalents in 3,900 units located in 65 housing developments. Statistical and theoretical analyses completed for HUD are available through the Lead Clearinghouse at 1-800-424-LEAD and in Appendix 12.

Second, and perhaps more important, none of the 65 developments had lead-based paint in 5 to 10 percent of the units. That indicates lead-based paint in this range is likely to be quite rare and that plausible increases in sampling to improve detection in this range will fail to improve confidence in the results significantly. Most painting follows a pattern: Property owners or managers often paint all surfaces, all components within a room, or similar components in all rooms in a unit when there is tenant turnover. It is unlikely that lead-based paint distributions are completely random, as assumed in the 1995 edition of the *Guidelines*. From the available data, there appears to be no significant benefit to increasing the number of units to be sampled to detect a prevalence rate of 5 to 10 percent, because few developments are likely to be in that range. In short, the sampling design presented here will yield a more targeted, cost-effective approach to identifying lead-based paint where it is most likely to exist.

B. Selection of Housing Units, Common Areas, and Exterior Site Areas.

The first step in selecting housing units is to identify buildings in the development with a common construction based on written documentation or visual evidence of construction type. Such buildings can be grouped together for sampling purposes. For example, if two buildings in the development were built at the same time by the same builder and appear to be of similar construction, all of the units in the two buildings can be grouped for sampling purposes, as can the common areas, and exterior site areas. Units can have different sizes, floor plans, and number of bedrooms and still be grouped allowing use of table 7.3 to determine the minimum number to be inspected. Similar common areas can be grouped for sampling purposes using the table to determine the minimum number to be inspected, as can similar exterior sites. (Do *not* add the number of units, common areas and exterior sites, and then use the table for the total.)

Table 7.3 Number of Units to be Tested in Multi-family Building or Developments*

Number of Similar Units, Similar Common Areas, or Similar Exterior Sites	Pre-1960 or Unknown-Age Building or Development: Number of Units to Test *	1960-1977 Building or Development: Number of Units to Test *
1-10	All	All
11-13	All	10
14	All	11
15	All	12
16-17	All	13
18	All	14
19	All	15
20	All	16
21-26	20	16
27	21	17
28	22	18
29	23	18
30	23	19
31	24	19
32	25	19
33-34	26	19
35	27	19
36	28	19
37	29	19
38-39	30	20
40-48	31	21
49-50	31	22
51	32	22
52-53	33	22
54	34	22
55-56	35	22
57-58	36	22
59	37	23
60-69	38	23
70-73	38	24
74-75	39	24
76-77	40	24

Number of Similar Units, Similar Common Areas, or Similar Exterior Sites	Pre-1960 or Unknown-Age Building or Development: Number of Units to Test *	1960-1977 Building or Development: Number of Units to Test *
78-79	41	24
80-88	42	24
89-95	42	25
96-97	43	25
98-99	44	25
100-109	45	25
110-117	45	26
118-119	46	26
120-138	47	26
139-157	48	26
158-159	49	26
160-177	49	27
178-197	50	27
198-218	51	27
219-258	52	27
259-279	53	27
280-299	53	28
300-379	54	28
380-499	55	28
500-776	56	28
777-939	57	28
940-1004	57	29
1005-1022	58	29
1023-1032	59	29
1033-1039	59	30
1500	87	44
2000	116	58
2500	145	73
3000	174	87
3500	203	102
4000	232	116

* For brevity, "Number of Units" and "Number of Units to Test" are used, but the number to test is the same for similar units, similar common areas, and similar exterior sites.

The specific units to be tested should be chosen *randomly* from a list of all units in each building or buildings. (For brevity, just “units” are mentioned in describing the random selection procedure, but the procedure is the same for similar units, similar common areas, and similar exterior sites.) The “Selection of Units” form (Form 7.4) or a comparable form may be used to aid in the selection process. A complete list of all units in each group should be used and a separate identifying sequential number must be assigned to each unit. For example, if apartment addresses are shown as 1A, 1B, 2A, 2B etc., they must be given a sequence number (1, 2, 3, 4, etc.).

Obviously, units without identifiers could not be selected for inspection and would thus bias the sampling scheme. The list of units should be complete and verified by consulting building plans or by a physical inspection of the development.

Specific units to be tested should be selected randomly using the formula below, and a table of random numbers or the random number function on a calculator. Tables of random numbers are often included in statistics books. Today’s common full-function computer spreadsheet software products (e.g., Apple’s Numbers, Corel’s Quattro Pro, Microsoft’s Excel, and OpenOffice.org’s Calc,)¹ have random number generator functions of sufficient quality for use in lead-based paint inspections. Inspectors are, therefore, advised to use them to obtain the random numbers, which can then be used to select the specific numbered units. A unit number is selected by rounding up the product of the random number times the total number of units in the development to the *next* whole number. That is:

Housing Unit number = Random number *times* Total number, rounded up, where:

Housing Unit number = the identification number for a unit in a list;

Random number = a random number between 0 and 1; *and*

Total number = the total number of units in a list of units.

For example, if there is a total of 50 units in the development, and one of the random numbers is 0.196411, the product of the total number of units *times* that random number (50×0.196411) is 9.82055, which is rounded up to 10, which would point to the 10th unit on the list of units.

The same unit may be selected more than once by this procedure. For example, another of the random numbers in the 50-unit development example above could be 0.18347, for which the product (50×0.18347) would be 9.1735, which is also rounded up to 10, pointing to the same 10th unit on the list. Because each unit should be tested only once, duplicate selection should be documented and then the duplicate unit should be discarded. The selection procedure should be continued until an adequate number of units have been selected.

The “Selection of Units” form (Form 7.4 in Addendum 2) is completed by filling in as many random numbers as are needed in the appropriate column. Numbers for the third column are obtained by multiplying the total development size by each random number. Numbers for the fourth column are obtained by rounding up from the previous calculation to the next whole number. If the whole number in the fourth column has already been selected, that selection should not be entered again. The notation “DUP” should be entered to show that the selection was a duplicate. This process should continue until the required number of distinct sample numbers has been selected. Common areas and exterior room equivalents should be identified at this time, but they are not considered to be separate units. Addendum 1, Examples of Lead-Based Paint Inspections, includes detailed guidance on the random selection procedure in multi-family housing, and other information about single-family and multi-family inspections.

C. Listing Testing Combinations and Common Areas

The “Multi-family Housing LBP Testing Data Sheet” form (Form 7.5 in Addendum 2) – or a comparable form – should be used to list the testing combinations in each unit, common area and exterior site that was selected for inspection. In multi-family housing, the inventory of testing combinations often will be similar for units that have the same number of bedrooms. The inspector should, however, list testing combinations that are unique to each tested unit. For example, some units may contain built-in cabinets while others do not. The selection of testing combinations should, therefore, be carried out independently in each inspected unit.

As in single family housing, take readings on all testing combinations in all room equivalents in each unit selected for testing. However, common areas need to be identified and tested as well.

Common Areas

Similar common areas and similar exterior sites must always be tested, but in some cases they can be sampled in much the same way that dwelling units are. Common areas and building exteriors typically have a similar painting history from one building to the next. In multi-family housing, each common area (such as a building lobby, laundry room, or hallway) can be treated like a dwelling unit. If there are multiple similar common areas, they may be grouped for sampling purposes in exactly the same way as regular dwelling units are. However, dwelling units, common areas and exterior sites cannot all be mixed together in a single group.

All testing combinations within each common area or on building exteriors selected for testing must be inspected. This includes playground equipment, benches and miscellaneous testing combinations located throughout the development. The specific common areas and building exteriors to test should be randomly selected, in much the same way as specific units are selected using random numbers. (See section IV.B, above.)

The number of common areas to test should be taken from Table 7.3. In this instance, common areas and building exteriors can be treated in the same way as housing units (although they are not to be confused with true housing units).

D. Classification of XRF Results in Multi-family Housing

The inspector should record each XRF reading for each testing combination on the “Multi-family Housing LBP Testing Data Sheet,” (Form 7.5) or a comparable form, and indicate whether that testing combination was classified as positive, negative, or inconclusive as described previously for single-family housing.

When the inspection is completed in all of the selected units and the classification rules have been applied to all XRF results, the “Multi-family Housing: Component Type Report” form (Form 7.6) or a comparable form should be completed. Building component types – groups of like components constructed of the same substrate in the multi-family housing development – are aggregated on this form. For example, grouping all interior walls would create an appropriate component type if all walls are plaster. Grouping all doors would not be appropriate; however, if some doors are metal and some are wood. At least 40 testing combinations of a given component type in a multi-family housing development must be tested to obtain the desired level of confidence in the results for that component type. (Refer to Appendix 12 of these *Guidelines* for the statistical rationale for this minimum number of component types to test.) If fewer than 40 testing combinations of a given component type were tested, test additional combinations of that component type. If fewer than 40 components of a given type exist in the units to be tested, test all of the components that do exist.

In some cases additional sampling of the specific component may not be necessary. If no lead at or above the standard is found on that component type, additional measurements should be taken in other units to increase the sample size to 40. However, if all or most of the sampled component types are positive, no further sampling is needed, provided that the building owner agrees with this reduction of testing. For example, if 20 out of 60 doors are tested, and the majority is positive for lead-based paint, all similar doors in the buildings may be presumed positive; only those doors tested and found negative may be treated as negative. Note that the inspector and owner may not presume a component is negative. All required XRF testing and/or laboratory analysis must be completed to conclude that any or all components included in a given component type are negative.

On the “Multi-family Housing: Component Type Report” form, the substrate and the component for each component type should be recorded under the heading “Description” (for example, wooden interior doors), as should the total number of testing combinations included in the component type. In addition, for each component type, the aggregated positive, negative, and inconclusive classifications should be recorded as described below. Record the number and percentage of testing combinations classified as:

- ◆ **Positive** for lead-based paint. This is based upon a positive XRF reading in accordance with the XRF’s Performance Characteristic Sheet;
- ◆ **Low Inconclusive** for lead-based paint. This is based on having XRF readings less than the midpoint of the XRF’s inconclusive range (if the XRF instrument does not have an inconclusive range (that is, it has a threshold value), this aggregation element should not be provided);
- ◆ **High Inconclusive** (high) for lead-based paint. This is based on having XRF readings equal to or greater than the midpoint of the XRF’s inconclusive range (if the XRF instrument does not have an inconclusive range (that is, it has a threshold value), this aggregation element should not be provided); and
- ◆ **Negative** for lead-based paint.

The “Multi-family Decision Flowchart” (figure 7.3) should be used to interpret the aggregated XRF testing results in the “Multi-family Housing: Component Type Report” form. The flowchart is applied separately to each component/substrate type (wood doors, metal window casings, etc.) and shows one of the following results:

- ◆ **Positive:** Lead based-paint is present on one or more of the components.
- ◆ **Negative:** Lead based-paint is not present on the components throughout the development. (Lead may still be present at lower loadings and hazardous leaded dust may be generated during modernization, renovation, repair, remodeling, maintenance, painting or other disturbances of painted surfaces.)

These results are obtained by following the flowchart. The decision that lead-based paint is present is reached with 99 percent confidence if 15 percent or more of the components are positive. (Refer to Appendix 12 for the statistical rationale for this percentage.) The decision that lead-based paint is not present throughout the development is reached if:

- (1) 100 percent of the tested component types are negative, or
- (2) 100 percent of the tested component types are classified as either negative or inconclusive *and* all of the inconclusive classifications have XRF readings less than the midpoint of the inconclusive range for the XRF in use.
 - ◆ Note that the midpoint of the inconclusive range is *not* a threshold; it is used only for classifying XRF readings in multi-family housing in conjunction with information about other XRF readings as

FIGURE 7.3 Multi-family Decision Flowchart



¹ "Positive," "negative," and "inconclusive XRF readings are determined in accordance the XRF instrument's Performance Characteristic Sheet (PCS) as described in Chapter 7 of the HUD *Guidelines for the Evaluation and Control of Lead Hazards in Housing*.

² A high inconclusive reading is an XRF reading at or above the midpoint of the inconclusive range (if it equals) around 1.0 mg/cm² for the instrument model that is used (see PCS).
For example, if the model's PCS states the inconclusive range is 0.41 to 1.39, then the midpoint would be 0.90. A high inconclusive reading would be from 0.90 to 1.39, and a low inconclusive reading would be from 0.41 to 0.39.

³ You may assume any part or coating contains lead-based paint, even without XRF or laboratory analysis. Similarly, you may confirm any XRF reading by laboratory analysis.

described here. (See section 2 below for guidance on what to do when the percentage of positive readings is less than 5%.)

- ◆ For cases with greater than or equal to 5% positives *and* less than 15% positives, as well as no positives but greater than 15% high inconclusives, some confirmatory laboratory testing may be needed to reach a final conclusion, unless the client wishes to assume the validity of the XRF results and that all inconclusives are positive.
 - For each testing combination with an inconclusive XRF reading at or above the midpoint of the inconclusive range, a paint-chip sample should be analyzed by a laboratory recognized by the EPA NLLAP for the analysis of lead in paint.
 - If all the laboratory-analyzed samples are negative, it is not necessary to test inconclusive XRF results below the midpoint of the inconclusive range.
 - If, however, *any* laboratory results are positive on a component type, all inconclusives equal to or above the midpoint of the inconclusive range should be analyzed, or they should be presumed to be positive.
- ◆ Once all laboratory results have been reported, the “Multi-family Housing: Component Type Report” form should be updated to include the laboratory results and classifications (either positive or negative).

The “Multi-family Decision Flowchart” is based on data collected by EPA in a large field study of XRF instruments (EPA 1995b). Percentages were chosen so that, for each component type, there is a 98 percent chance of correctly concluding that lead-based paint is either absent on all components or present on at least one component of a given type. Thus, the probability that a tested component type will be correctly classified is very high.

Percentages of positive or inconclusive results are computed by dividing the number in each classification group by the total number of testing combinations of the component type that were tested. For example, if 245 wooden doors in a multi-family housing development were tested and 69 were classified as inconclusive with XRF readings less than the midpoint of the inconclusive range, 28 percent $[(69 / 245) \times 100 \text{ percent} = 28.2 \text{ percent}]$ should be recorded on the form in the “<1.0 percent” columns under the heading “Inconclusive.”

1. Unsampld Housing Units

If a particular component type in the sampled units is classified as positive, that same component type in the unsampled units is also classified as positive. For those cases where the number of positive components is small, further analysis may determine if there is a systematic reason for the specific mixture of positive and negative results.

For example, suppose that a few porch railings tested negative, but most tested positive. Examination of the sample results in conjunction with the building records showed that the porch railings classified as positive were all original and the railings classified as negative were all recent replacements. The records did not reveal which units had replaced railings, and due to historic preservation requirements, the replacement railings were identical in appearance to the old railings. Thus, all unsampled original porch railings could be classified as positive, and all unsampled recently replaced porch railings could be classified as negative if at least 40 of the replaced porch railings had been tested.

2. Fewer than 5% Positive Results

Where a small fraction of XRF readings, less than 5 percent, of a particular component type are positive, several choices are available:

- ◆ First, the inspector may confirm the results by laboratory analysis, which is considered definitive when performed as described in section VI, below; a laboratory lead result of 1.0 mg/cm² or greater (or 0.5 percent by weight or greater) is considered positive.
- ◆ Second, the inspector may select a second random sample (using unsampled units only) and test the component type in those units. If less than 2.5% of the combined set of results is positive, the component type may be considered as having lead-based paint in isolated locations, but not having lead-based paint development-wide, with a reasonable degree of confidence. Individual components that are classified positive should be considered as being lead-based painted and managed or abated appropriately.
- ◆ Finally, if the client chooses not to confirm the results by laboratory analysis and not to take a second set of measurements, then the component type should be considered as having lead-based paint development-wide.

The inspector may wish to advise the client that the cost of additional XRF testing or laboratory analysis is usually much less than the cost of lead abatement or interim control projects. This is of particular interest in the situation where few results are positive, because there is a significant chance that the paint, development-wide, may not be lead-based.

Whatever approaches are used, all painted individual surfaces found to be positive for lead must be included in the inspection report, regardless of development-wide conclusions.

E. Documentation in Multi-family Housing

The method for documentation is identical for multi-family and single-family housing (see section IV.I), with the following exception: Use forms 7.2 through 7.6 for multi-family housing (see Addendum 2) or comparable forms, not the single-family housing forms.

When lead-based paint has been found in some units it must be managed or treated as such in those units, even if the inspection indicates that it is not present development-wide.

VI. Laboratory Testing for Lead in Paint-chip Samples

For inconclusive XRF results, areas that cannot be tested using an XRF instrument, and for client-approved confirmation of XRF, a paint-chip sample should be collected using the protocol outlined here and in Appendix 13.2 of these *Guidelines* and/or ASTM E1729, Standard Practice for Field Collection of Dried Paint Samples for Subsequent Lead Determination. The sample should be analyzed by a laboratory recognized under the EPA National Lead Laboratory Accreditation Program (NLLAP) for the analysis of lead in paint using the analytical method(s) it used to obtain the laboratory's recognition. If a paint-chip sample cannot be collected, the inspection report should include a list of surfaces where paint-chip samples were needed but not taken; the paint on these components is presumed positive.

A. Number of Samples

Only one paint-chip needs to be taken for each testing combination. Additional samples can be collected as a quality control measure, if desired, and are recommended.

B. Size of Samples

The paint-chip sample should be taken from a 4-square-inch (25-square-centimeter) or larger area that is representative of the paint on the testing combination, as close as possible to any XRF reading location and, if possible, unobtrusive (see Figure 7.4). This area may be a 2 by 2 inch (5 by 5 centimeter) square, or a 1 by 4 inch (2½ by 10 centimeter) rectangle, or have any other dimensions that equal at least 4 square inches (25 square centimeters). Regardless of shape, the dimensions of the surface area must be accurately measured (to the nearest 1/16th of an inch or millimeter) and recorded, so that laboratory results can be reported in mg/cm². Results should be reported as percent by weight if the dimensions of the surface area cannot be accurately measured or if all paint within the sampled area cannot be removed. In these cases, lead should be reported in ppm or percent by weight, *not* in mg/cm². Smaller surface areas can be used if acceptable to the laboratory. The 4-square-inch (25-square-centimeter) area practically guarantees that a sufficient amount of paint will be collected for laboratory analysis. As a result, samples will sometimes weigh more than required for some laboratory analysis methods. Smaller-sized paint-chips may be collected if permitted by the laboratory (see ASTM E1729). In all cases, the inspector should consult with the NLLAP-recognized laboratory selected regarding specific requirements for the submission of samples for lead-based paint analysis.

C. Inclusion of Substrate Material

Inclusion of small amounts of substrate material in the paint-chip sample will result in minimal error if results are reported in mg/cm², but including any amount of substrate can result in less precise results, with worse effect as the amount of substrate increases. Substrate material shall not be included if results are to be reported in weight percent (or ppm) (see Figure 7.5).

D. Repair of Sampled Locations

Property owners or managers should ensure that areas from which paint-chip samples are collected should be repaired and cleaned, unless the area will be removed, encapsulated, enclosed,



FIGURE 7.4 Preparing to take a paint-chip sample for laboratory analysis.



FIGURE 7.5 Removing paint-chip sample.

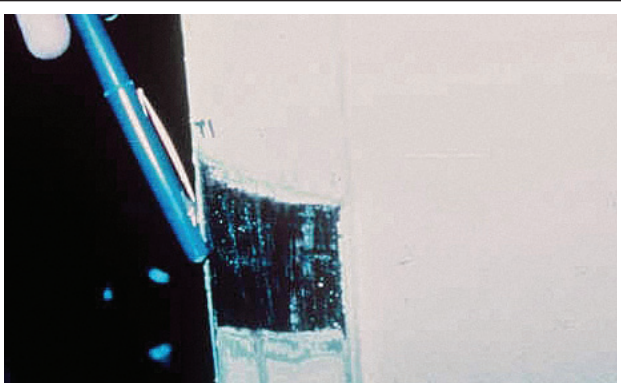


FIGURE 7.6 Damage caused by removal of paint-chip from substrate.

or repainted before occupancy. (Lead-based paint inspectors and risk assessors are not generally responsible for repainting, unless specified in their contracts.) Repairs can be completed by repainting, spackling, or any other method of covering that renders the bare surface inaccessible. Cleanup should be done with wet wiping and rinsing, and it should be done on both the surface and the floor underneath the surface sampled. The new covering or coating should have the same expected longevity as new paint or primer. Repair is not necessary if analysis shows that the paint is not lead-based paint and leaving the damage is acceptable to the client and/or the owner (see Figure 7.6).

E. Classification of Paint-chip Sample Results

Any paint inspections may be carried out using only paint-chip sampling and laboratory analysis at the option of the client, such as the property owner or manager or other purchaser of the inspection services. This option is not recommended because it is time consuming, costly, and requires extensive repairs. Paint-chip sampling also has opportunities for errors, such as inclusion of substrate material (for results in weight percent), failure to remove all paint from an area (including paint that has bled into a substrate) and laboratory error. Nevertheless, paint-chip sampling generally has a smaller error than does XRF and is, therefore, appropriate as a final decision-making tool. Laboratory results of 1.0 mg/cm^2 or greater, or 0.5 percent or greater, are to be considered positive. If the laboratory reports both mg/cm^2 and weight percent for a sample, if either result is positive, use that one for final classification, or both, if they are both positive. In the rare situation where more than one paint-chip sample from a single testing combination is analyzed, the combination is considered positive if any of those samples is positive. All other results are negative. No inconclusive range is reported for laboratory measurements.

F. Units of Measure

Results should be reported in mg/cm^2 , the primary unit of measure for lead-based paint analyses of surface coatings. Results should be reported as percent by weight only if the dimensions of the surface area cannot be accurately measured or if not all paint within the sampled area can be removed. In these cases, results should not be reported in mg/cm^2 , but in weight percent.

Weight measurements are usually reported as micrograms per gram ($\mu\text{g/g}$), milligrams per kilogram (mg/kg), or parts per million (ppm) by weight. For example, a sample with 0.2 percent lead may also be reported as 2,000 $\mu\text{g/g}$ lead, 2,000 mg/kg lead, or 2,000 ppm lead.

G. Sample Containers

Samples should be collected in sealable rigid containers such as screw-top plastic centrifuge tubes, rather than plastic bags which generate static electricity and make quantitative transfer of the entire paint sample in the laboratory impossible. Paint-chip collection should include collection of all the paint layers from the substrate, but collection of actual substrate should be minimized. Refer to ASTM E 1729 and Appendix 13 of these *Guidelines* for further details on collection of paint-chip samples.

H. Laboratory Analysis Methods

Several standard laboratory technologies are useful in quantifying lead levels in paint-chip samples. These methods include, but are not limited to, Atomic Absorption Spectroscopy (AAS), Inductively Coupled Plasma-Atomic Emission Spectroscopy (ICP-AES), Anodic Stripping Voltammetry (ASV), and Potentiometric Stripping Analysis (PSA).

For analytical methods that require sample digestion, samples should be pulverized so that there is adequate surface area to dissolve the sample before laboratory instrument measurement. In some cases, the amount of paint collected from a 4-square-inch (25-square centimeter) area may exceed the amount of paint that can be analyzed successfully. It is important that the actual sample mass analyzed not exceed the maximum mass the laboratory has successfully tested using the specified method. If subsampling is required to meet analytical method specifications, the laboratory must homogenize the paint-chip sample (unless the entire sample will eventually be analyzed and the results of the subsamples combined). Without homogenization, subsampling would likely result in biased, inaccurate lead results (see ASTM E 1645 Standard Practice for Preparation of Dried Paint Samples by Hotplate or Microwave Digestion for Subsequent Lead Analysis, and ASTM E1979 Standard Practice for Ultrasonic Extraction of Paint, Dust, Soil, and Air Samples for Subsequent Determination of Lead).

If the sample is properly homogenized and substrate inclusion is negligible, the result can be reported as a loading, in milligrams per square centimeter (mg/cm^2), the preferred unit, or as percent by weight, or both. The following equation should be used to report the results in milligrams per square centimeter:

$$\text{mg}/\text{cm}^2 = \frac{\text{weight of lead from sample subsample (in mg)} \times \left(\frac{\text{total sample weight (in g)}}{\text{subsample weight (in g)}} \right)}{\text{area (in cm}^2\text{)}}$$

To report results in weight percent, the following equation should be used:

$$\text{Weight percent} = \frac{\text{weight of lead from subsample (in } \mu\text{g)}}{\text{subsample weight (in } \mu\text{g)}} \times 100\%$$

To report results in micrograms per gram ($\mu\text{g}/\text{g}$), the following equation should be used:

$$\mu\text{g}/\text{g} = \frac{\text{weight of lead from subsample (in } \mu\text{g)}}{\text{subsample weight (in g)}}$$

If the laboratory reports results in both mg/cm^2 and weight percent, and if one result is positive and the other negative, the sample is classified as positive.

Whatever the preparation techniques of paint-chip samples (including homogenization, grinding, and digestion), and instrument selection and operation selected, the inspector should verify, prior to the collection and submission of samples, that the laboratory is approved to perform the appropriate analytical methodologies. Methods should be applied to paint-chip materials of approximately the same mass and lead loading (also called area concentration, measured in mg/cm^2) as those samples anticipated from the field.

Because of the potential for sample mass to affect the precision of lead readings, laboratory analysis reference materials processed with field samples for quality assurance purposes should have close to the same mass as those used for paint-chip samples. Refer to ASTM E1645 or equivalent methods for further details on laboratory preparation of paint-chip samples, and refer to ASTM E1613, ASTM E2051, or equivalent methods on analysis of samples for lead, and the related E1775 Guide for Evaluating Performance of On-Site Extraction and Field-Portable Electrochemical or Spectrophotometric Analysis for Lead.

I. Laboratory Selection

A laboratory used for lead-based paint analysis must be recognized under EPA's National Lead Laboratory Accreditation Program (NLLAP) for analysis of lead in paint, with one exception. The exception is for analyzing samples collected where States or Tribes operate an EPA-authorized lead-based paint inspection certification program that has paint testing requirements different from the EPA requirements, in which case the State or Tribal requirements must be followed. NLLAP-recognized laboratories are required to use the same analytical methods for analyzing the sample that they used to obtain NLLAP recognition.

EPA established NLLAP to provide the public with laboratories that have a demonstrated capability for analyzing lead in paint-chip, dust, and/or soil samples at the levels of concern stated in these *Guidelines*. NLLAP monitors the analytical proficiency, management and quality control procedures of each laboratory participating in the program. NLLAP does not specify or recommend analytical methods. Information on this program can be obtained by calling the National Lead Information Center at 1-800-424-LEAD. (Hearing- or speech-challenged individuals may access this number through TTY by calling the toll-free Federal Relay Service at 800-877-8339.) Useful information on the NLLAP program is available on the EPA web site at <http://www.epa.gov/lead/pubs/nllap.htm>.

To participate in NLLAP, a laboratory must, as summarized on the EPA's NLLAP web page, <http://www.epa.gov/lead/pubs/nllap.htm>:

- ◆ Be accredited by an organization EPA recognizes as an accrediting body for lead sample analysis. As part of the accreditation process, a laboratory undergoes a systems audit, including an on-site visit, by one of the accrediting bodies. To apply for accreditation as a lead sample analysis laboratory recognized under NLLAP, laboratories contact an accrediting body. NLLAP specifies quality control and data reporting requirements, as described in its "Laboratory Quality System Requirements," (LQSR) which, as of the publication of this edition of these *Guidelines*, was in version 3 (<http://www.epa.gov/lead/pubs/lqsr3.pdf>). EPA has developed a Model Memorandum of Understanding (<http://www.epa.gov/lead/pubs/nllapmou.pdf>) for other organizations, including States and Tribes, to become NLLAP accrediting bodies. As of the publication of these *Guidelines*, EPA recognized three such NLLAP accrediting bodies.
- ◆ Participate successfully in the periodic (currently quarterly) Environmental Lead Proficiency Analytical Testing Program (ELPAT), administered by the AIHA Proficiency Analytical Testing Programs, LLC (an affiliate of the American Industrial Hygiene Association (AIHA)) in cooperation with the Centers for Disease Control and Prevention's (CDC's) National Institute for Occupational Safety and Health (NIOSH), and EPA. The proficiency testing samples used in ELPAT consist of various levels of lead in paint, dust, and soil matrices. An accredited laboratory is recognized only for the analysis of only those matrices for which it is proficient; the laboratory

decides which matrices it will analyze for lead for purposes of obtaining NLLAP recognition. Field-portable XRF measurement of lead in paint does not involve collecting a sample of the paint, so it is not covered by NLLAP, and the measurements need not be performed by an NLLAP-recognized laboratory. See Chapter 7 for further guidance.

Field-portable XRF analysis has been used for measurement of lead in dust (Sterling, 2000; Harper, 2002) or soil (EPA, 2004; Binstock, 2009) with varying degrees of success; these methods do involve collecting a sample of the medium, so samples collected from target housing or pre-1978 child-occupied facilities, must be analyzed by a laboratory recognized by NLLAP for analysis of lead in the particular medium. The laboratory may be a mobile laboratory, field sampling and measurement organization, or a fixed-site laboratory, as discussed in Section II.E.6, above.

Information on NLLAP, including an up-to-date list of fixed-site and mobile laboratories recognized by NLLAP, can be obtained on the EPA web site at <http://www.epa.gov/lead/pubs/nllap.htm>, or by calling the National Lead Information Center at 800-424-LEAD. (Hearing- or speech-challenged individuals may access this number through TTY by calling the toll-free Federal Relay Service at 800-877-8339.)

J. Laboratory Report

The laboratory report for analysis of paint samples for lead should include both identifying information and information about the analysis. At a minimum, this should include the information outlined in the LQSR version 3's section 5.10.2, Test Reports. In addition to the minimum requirements in that section, test reports containing the results of sampling must include specified sampling information, if available. (Inspectors may find the LQSR version 3's Appendix I, Acronyms and Glossary of Terms Associated with the NLLAP, helpful.)

VII. XRF Hazards

As the U.S. Nuclear Regulatory Commission (NRC) notes, "ionizing radiation (such as x-rays and cosmic rays) is more energetic than non-ionizing radiation. Consequently, when ionizing radiation passes through material, it deposits enough energy to break molecular bonds and displace (or remove) electrons from atoms. This electron displacement creates two electrically charged particles (ions), which may cause changes in living cells of plants, animals, and people." (www.nrc.gov/about-nrc/radiation/health-effects/radiation-basics.html)

XRF instruments used in accordance with the manufacturer's instructions will not cause significant exposure to ionizing radiation. The operator should be trained by the instrument's manufacturer (or equivalent), instrument's shutter should never be pointed at anyone, even if the shutter is closed, it should be in the operator's possession at all times, it should not be dropped or tossed, and no one should ever defeat or override any of its safety mechanisms.

Some portable XRF instruments used for lead-based paint inspections contain one or more radioactive isotopes that emit X-rays and gamma radiation; some portable XRF instruments use an X-ray tube to generate X-rays. Proper safety training and handling of these instruments is required to protect the instrument operator and any other persons in the immediate vicinity during XRF usage.

A. Licenses and Certifications for Using XRFs with Radioactive Sources

In addition to training and certification in lead-based paint inspection, a person using a portable XRF instrument for inspection that has (one or more) radioactive X-ray sources must have valid licenses or permits from the appropriate Federal, State, and local regulatory bodies to possess (through ownership or lease), and to operate, such an instrument.

All portable XRF instrument operators should be trained by the instrument's manufacturer (or equivalent). XRF operators using an instrument with a radioactive source should provide related training, licensing, permitting, and certification information to the person who has contracted for their services before an inspection begins. Depending on the State, such operators may be required to hold three forms of proof of competency: manufacturer's training certificate (or equivalent) for the operator, a radiation safety license for the firm or entity using the XRF, and a State lead-based paint inspection certificate or license to perform the requested inspection services. To help ensure competency and safety, HUD and EPA recommend that clients hiring inspectors who will use XRF instruments with a radioactive source hire only those who hold all three forms of proof of competency.

The regulatory body responsible for oversight of the radioactive materials contained in portable XRF instruments depends on the type of material being handled. Some radioactive materials are federally regulated by the NRC; others are regulated at the State level. States are generally categorized as "agreement" or "non-agreement" States. An agreement State has an agreement with NRC to regulate radioactive materials that are generally used for medical or industrial applications. (www.nrc.gov/about-nrc/state-tribal/agreement-states.html) (Most radioactive materials found in XRF instruments are regulated by agreement States). For non-agreement States, NRC retains this regulatory responsibility directly. At a minimum, however, most State agencies require prior notification that a specific XRF instrument is to be used within the State. Fees and other details regarding the use of portable XRF instruments vary from State to State. Contractors who provide inspection services must hold current licenses or permits for handling XRF instruments, and must meet any applicable State or local laws or notification requirements.

Requirements for radiation dosimetry by the XRF instrument operator (wearing dosimeter badges to monitor exposure to radiation) are generally specified by State regulations, and vary from State to State. In some cases, for some isotopes, no radiation dosimetry is required. Because the cost of dosimetry is low, it should be conducted, even when not required, for the following four reasons:

- ◆ XRF instrument operators have a right to know the level of radiation to which they are exposed during the performance of the job. In virtually all cases, the exposure will be far below applicable exposure limits.
- ◆ Long-term collection of radiation exposure information can aid both the operator (employee) and the employer. The employee benefits by knowing when to avoid a hazardous situation; the employer benefits by having an exposure record that can be used in deciding possible health claims.
- ◆ The public benefits by having exposure records available to them.
- ◆ The need for equipment repair can be identified more quickly.

B. Safe Operating Distance

All XRF Instruments: XRF instruments used in accordance with manufacturer's instructions will not cause significant exposure to ionizing radiation. But the instrument's shutter should never be pointed at anyone, even if the shutter is closed. The safe operating distance between an XRF instrument and a person during inspections depends on the source type, radiation intensity, quantity (if any) of radioactive material, and the density of the materials being surveyed. As the radiation source intensity increases, the required safe distance also increases. Placing materials, such as a wall, in the direct line of fire, reduces the required safe distance. Persons should not be near the other side of a wall, floor, ceiling or other surface being tested. Operators should verify that this is indeed the case prior to initiating XRF testing activities, and check on it during testing (see Figure 7.7).



FIGURE 7.7 Lead inspectors should operate XRF instruments at a safe distance from others.

XRF Instruments with Radioactive Sources: According to NRC rules regarding radioactive sources of radiation, the radiation dose to a member of the general public must not exceed 2 millirems per hour. (10 CFR 20.1301(a)(2). (The regulation can be found through <http://ecfr.gpoaccess.gov/>, or at <http://www.nrc.gov/reading-rm/doc-collections/cfr/part020/part020-1301.html>.) This can be compared to the 0.07 millirems per hour the NRC says is the average American radiation dose. One of the most intense sources used in portable XRF instruments is a 40-millicurie ⁵⁷Co (Cobalt-57) radiation source. Other radiation sources in current use for XRF testing of lead-based paint generally produce lower levels of radiation. Generally, an XRF operator conducting inspections according to manufacturer's instructions would be exposed to radiation well below the regulatory level. One study found that exposures to radiation during operation of a Scitec MAP 3 XRF were 132 microrem/day (Wisconsin, 1994). Typically, XRF instruments with lower gamma radiation intensities can use a shorter safe distance provided that the potential exposure to an individual will not exceed the regulatory limit.

If these practices are observed, the risk of excessive exposure to ionizing radiation is extremely low and will not endanger any inspectors or occupants present in the dwelling.

References

- Binstock, 2009. Binstock, D.A.; Gutknecht, W.F. McWilliams, A.C. "Lead in Soil - An Examination of Paired XRF Analysis Performed in the Field and Laboratory ICP-AES Results," *International Journal of Soil, Sediment and Water*. 2:2(1), 2009. <http://scholarworks.umass.edu/intljssw/vol2/iss2/>
- EPA, 1995b. U.S. Environmental Protection Agency, *A Field Test of Lead-Based Paint Testing Technologies: Technical Report*, EPA 747-R-95-002b, May 1995.
- EPA, 2004. U.S. Environmental Protection Agency, X-ray Fluorescence (XRF) Instruments. Frequently Asked Questions (FAQ). <http://epa.gov/superfund/lead/products/xrffaq.pdf>
- Harper, 2002. Harper M, Hallmark TS, Bartolucci AA. A comparison of methods and materials for the analysis of leaded wipes. *J. Environmental Monitoring*, 4(6):1025-33, December 2002. <http://pubs.rsc.org/en/Content/ArticleLanding/2002/EM/b208456m>
- HUD, 2011. U.S. Department of Housing and Urban Development, American Healthy Homes Survey: Lead and Arsenic Findings. April 2011. http://portal.hud.gov/hudportal/documents/huddoc?id=AHHS_REPORT.pdf
- Jacobs, 2002. Jacobs David E., Robert P. Clickner, Joey Y. Zhou, Susan M. Viet, David A. Marker, John W. Rogers, Darryl C. Zeldin, Pamela Broene, and Warren Friedman. The prevalence of lead-based paint hazards in U.S. housing. *Environmental Health Perspectives*. 2002 Oct; 110(10): A599-606. <http://www.ncbi.nlm.nih.gov/pubmed/12361941>
- NIST, 2000. Rossiter, W.J., Jr., M. G. Vangel, M.E. McKnight and G. Dewalt, *Spot Test Kits for Detecting Lead in Household Paint: A Laboratory Evaluation*, National Institute of Standards and Technology, U.S. Department of Commerce, May 2000. NISTIR 6398. <http://fire.nist.gov/bfrlpubs/build00/PDF/b00034.pdf>
- Sterling, 2000. Sterling DA, Lewis RD, Luke DA, Shadel BN. A portable x-ray fluorescence instrument for analyzing dust wipe samples for lead: evaluation with field samples. *Environmental Research*, 83(2):174-9, June 2000. <http://www.sciencedirect.com/science/article/pii/S0013935100940581>.
- Westat, 1996. Westat, Inc., "An Analysis and Discussion of the Single Family Inspection Protocol Under the 1995 HUD Guidelines: Draft Report."
- Wisconsin 1994. Wisconsin Department of Health and Social Services, memo from Mark Chamberlain dated April 28, 1994.

Addendum 1: Examples of Lead-Based Paint Inspections

A. Example of a Single-Family Housing Inspection

The inspector completed the “Single-Family Housing LBP Testing Data Sheet,” recording “bedroom (room 5)” as the room equivalent and listing “plaster” as the first substrate. The completed inventory of testing combinations in the bedroom indicated the presence of wood, plaster, metal, and drywall substrates. Brick and concrete substrates were not present in the bedroom. Descriptions of all testing combinations in the bedroom were recorded. Completed form 7.1, Single Family LBP Test Data Sheet, shows the completed inventory for all testing combinations in the bedroom. (Completed forms are found in Addendum 2, after the blank forms.)

Before any XRF testing, the inspector noted the date and starting time in her field notes, and then performed the manufacturer’s recommended warm up procedures. The film was placed more than 12 inches (0.3 meters) away from any other surface. The inspector then took three calibration check readings (1.18 mg/cm², 0.99 mg/cm², and 1.07 mg/cm²) on the NIST SRM with a lead level of 1.02 mg/cm². Results of the first calibration check readings were recorded on the “Calibration Check Test Results” form (see Completed Form 7.2).

The inspector then averaged the three readings (1.08 mg/cm²), and computed the calibration difference (1.08 mg/cm² - 1.02 mg/cm² = 0.06 mg/cm²) and compared this to the calibration check tolerance shown in the *XRF Performance Characteristic Sheet* (see Completed Form 7.2) for the particular XRF make, model and testing mode used. The calibration difference was not greater than the 0.20 calibration check limits around the NIST SRM standard of 1.02 mg/cm², that is, the difference was within the range of 0.82 mg/cm² to 1.22 mg/cm², inclusive. The instrument was considered in calibration, and XRF testing could begin.

For each component type measured in a room equivalent, the inspector entered the replication number to record its amount/quantity type in that room equivalent. There were two closet doors in the room that were just like each other, so the replication number was 2. During the inspection, some components were not tested. To maintain a complete inventory of surfaces in the house, the inspector used the applicable code from the list at the bottom of Form 7.1. The codes were CPT = carpeted floor; ED = Entry Denied, for situations in which the owner, tenant or someone else denied the inspector access to the room or to test the particular component; IN = Inaccessible, for physical reasons, such as for situations in which the room was locked, debris in front of a window prevented reaching the window safely, etc.; and NC = Not Coated/Painted surface, for those surfaces that are not varnished, painted, lacquered or otherwise coated.

The inspector recorded the results from the XRF testing in the bedroom on the “Single-Family Housing LBP Testing Data Sheet.” At that point, the inspector was able to complete this form only through the XRF Reading column (see Completed Form 7.1). The remainder of the form was completed after the testing combinations in the house were inspected and correction values for substrate bias were computed. The inspector then moved on to inspect the next room equivalent.

The other bedroom, the kitchen, a living room, and a bathroom were also inspected. Three substrates – wood, drywall, and plaster – were found in these room equivalents. XRF testing for lead-based paint was conducted, using the same methodology employed in the first bedroom (room 5). After these five room equivalents were tested, the inspector noticed that all baseboards and all crown molding of the same substrate had XRF values of more than 5.0 mg/cm². The client had agreed earlier that testing could be abbreviated in this situation, so no further baseboard and crown molding testing combinations were tested in the remaining room equivalents. All similar remaining untested baseboard and crown molding with identical substrates were classified as positive in the final report based on the results of those tested. The raw data for the tested baseboards and crown moldings were also included in the final report.

Four hours after the initial calibration check readings, the inspector took another set of three calibration check readings. (If the inspection had taken less than 4 hours, as is common, the second calibration check test would have been conducted at the end of the inspection.) The readings were 1.45 mg/cm², 1.21 mg/cm², and 1.10 mg/cm²; the inspector recorded the results on the “Calibration Check Test Results” form (Completed Form 7.2). The inspector then averaged the three readings (1.25 mg/cm²), and computed the calibration difference (1.25 mg/cm² - 1.02 mg/cm² = 0.23 mg/cm²) and compared this to the calibration check tolerance shown in the *XRF Performance Characteristic Sheet* on Completed Form 7.2. The calibration difference exceeded the 0.20 calibration check tolerance. The inspector then marked “Failed calibration check” on the data sheets for those room equivalents that had been inspected since the last – successful calibration check test, and consulted the manufacturer’s recommendations. After trying, the instrument could not be brought back into control. Consequently, the inspector began using a backup instrument, after performing a calibration check and manufacturer’s warm up and quality control procedure. The calibration check test showed that the backup instrument was operating acceptably. The inspector used the backup instrument to reinspect the room equivalents checked with the first instrument, and then all the other room equivalents in the home. Next, because substrate correction was required for all results on wood and metal below 4.0 mg/cm² as specified in the *XRF Performance Characteristic Sheet* for the XRF model in use, the inspector prepared to take readings for use in the substrate correction computations. Using the random number function on a calculator and the list of sample location numbers, the inspector randomly selected two testing combinations each with wood and metal substrates where initial readings were less than 2.5 mg/cm², removed the paint from an area on each selected testing combination slightly larger than the faceplate of the XRF instrument, took three readings on the bare substrates, and recorded the readings on the “Substrate Correction Values” form (Completed Form 7.3). The inspector calculated the correction values for each substrate by averaging the six readings from the two test locations, rounded the result to the 2 places after the decimal point that the XRF instrument displayed, and recorded the information in the Correction Value row. The inspector then transferred the correction values to the “Single-Family Housing LBP Testing Data Sheet” for each corresponding substrate.

After the inspector had finished taking the readings needed to compute the substrate correction values, the inspector took another set of three calibration check readings. The inspector recorded the results on the “Calibration Check Test Results” form, under Second Calibration Check, for readings taken by the backup XRF instrument (Completed Form 7.2). The second (and final) calibration check average did not exceed the 0.20 calibration check tolerance. The inspector, therefore, deemed the XRF testing to be complete.

The inspector then calculated the corrected readings by subtracting the substrate correction value from each XRF result taken on a wood or metal substrate. The substrate correction value was obtained by averaging readings on bare surfaces that had initially measured less than 2.5 mg/cm² with the paint still on the surface (Completed Form 7.3). The inspector also used the inconclusive ranges obtained from the XRF Performance Characteristic Sheet (0.41 mg/cm² to 1.39 mg/cm²) for the particular XRF make, model and testing mode used, for all substrates except plaster (inconclusive range 1.01 mg/cm² to 1.09 mg/cm²). Based on the valid window sill XRF readings, including substrate corrections for wood, there were initially 10 positive results, 2 inconclusive results, and 3 negative results in the bedroom. The two inconclusive results required paint-chip sampling with laboratory confirmation; this resulted in one positive and one negative result.. When she completed entering information into the tables, and turned off and stored her equipment, the inspector noted the date and ending time of the inspection in her field notes.

B. Example of Multi-family Housing Inspection

This section presents a simple example of a multi-family housing development inspection. An actual inspection would have many more testing combinations than are provided here.

The inspector's first step was a visual examination of the development to be tested. During this pre-testing review, buildings with a common construction and painting history were identified and the date of construction – 1962 – was determined. The construction and painting history of all the units was found to be similar, so that units in the development could be grouped together for sampling purposes. The inspector determined that the development had 55 units, and by consulting Table 7.3, determined that 22 units should be inspected.

The inspector used the "Selection of Housing Units" form (Completed Form 7.4) to randomly select units to inspect. The total number of units, 55, was entered into the first column of the form. The random numbers generated from a calculator (a computer's spreadsheet program or database program could have been used as well) were entered into the second column. The first random number, 0.583, was multiplied by 55 (the total number of units), and the product, 32.0 (which showed the first decimal place of the 32.065 calculator result), was entered in the third column. The product was rounded up from 32.1 to 33, and 33 was written in the fourth column, indicating that the 33rd unit would be tested. Other units were selected using the same procedure. When a previously selected unit was chosen again, the inspector crossed out the repeated unit number and wrote "DUP" (for duplicate) in the last column. The inspector continued generating random numbers until 35 distinct units had been selected for inspection.

Some detailed guidance on the random selection process is as follows:

- ◆ An option, if more than half of the units are to be inspected, is to randomly determine the units that would *not* be inspected and then to select the remaining units for inspection.
- ◆ Random numbers: When using the random number, which will be a long string of digits, you may use just a few decimal place digits of the random number for the calculation:
 - When there are under 100 units being inspected, you may use just the first three decimal places.
 - For more than 100 units, you may use just the first four decimal places,
 - For more than 1000 units, you may use just the first five decimal places.

- Option: If you are using a computer to do the multiplication as well as generating the random number, you may use the random number as the computer generates it, without shortening it.
- ◆ Multiplications: In order to be clear on the form about how units are selected when the multiplication gives a result close to a whole number, the following procedure (or an equivalent procedure) should be used:
 - If the first decimal place of the product is from .1 to .8 (such as 55 times 0.107 = 5.885 in the second row of the filled-in Form 7.4), you may record and use just the **first** decimal place (such as 5.8). The housing unit number, which is the round-up to the next whole number, is 6 in this case.
 - If the first decimal place of the product is .0 (such as 55 times 0.873 = 48.015 in the third row of the form), or .9 (such as 55 times 0.636 = 34.980 in the fourth row from the bottom of the form), you may record and use just the **first two** decimal places, 48.01 and 34.98 in these two cases. The housing unit numbers, which are the round-ups to the next whole number, are 49 and 35 in these two cases.
 - Options: You may record and use the first two decimal places for all multiplications. If you are using a computer to do the multiplication as well as generating the random number, you may let the computer do the calculation without shortening the product. An example of the formulas that could be used is the following (showing the first three rows of the spreadsheet):

1	Total Number of Units	Random Number*	Random Number times Total Number of Units #	Round up for Unit Number to be Sampled
2	55	=RAND()	=A2*B2	=INT(C2+1)
3	55	=RAND()	=A3*B3	=INT(C3+1)

After identifying units to be inspected, the inspector conducted an inventory of all painted surfaces within the selected units. The inspector completed Form 7.5, the “Multi-family Housing LBP Testing Data Sheet” for every testing combination found in each room equivalent within each unit. This multi-family Form 7.5 is intentionally the same as the single family Form 7.1, and the instructions on using the form for single family housing, in Section A of this Addendum 1, above, apply to using it for multi-family housing. (Completed forms are found in Addendum 2, after the blank forms.) Completed Form 7.5 is an example of the completed inventory for the bedroom of the first unit to be inspected. The inventory showed that the bedroom was composed of four substrates and eight testing combinations of the following components: (1) one ceiling beam, (2) two doors, (3) four walls, (4) one window casing, (5) two door casings, (6) three shelves, (7) two support columns, and (8) one radiator. Where more than one of a particular component was present, except walls, one was randomly selected for XRF testing. Component location descriptions were recorded in the “Test Location” column. Drywall and brick substrates were not present in the bedroom.

Testing combinations not common to all units were added to the inventory list. The inspector also noted which types of common areas and exterior areas were associated with the selected units, identified each of these common and exterior areas as a room equivalent, and inventoried the corresponding testing combinations **based on the appropriate number of common areas and exteriors as is required by table 7.3.**

The inspector inventoried the remaining 34 units selected and their associated types of common areas and exterior areas before beginning XRF testing in the development. Alternatively, the inspector could have inventoried each room equivalent as XRF testing proceeded.

After completing the inventory, the inspector went to the first unit selected for sampling, and noted the date and starting time in her field notes. She then performed the XRF manufacturer's recommended warm up and quality control procedures successfully. Then the inspector took three calibration check readings on a 1.02 mg/cm² NIST SRM film. The calibration check was accomplished by attaching the film to a wooden board and placing the board on a flat wooden table. Readings were then taken with the probe at least 12 inches (0.3 meters) from any other potential source of lead. The following readings were obtained: 1.12, 1.00, and 1.08 mg/cm². These calibration check results were recorded on the "Calibration Check Test Results" form (Completed Form 7.2). The difference between the first calibration check average and 1.02 mg/cm² (NIST SRM) was not greater than the 0.3 mg/cm² calibration check tolerance limit obtained from the *XRF Performance Characteristic Sheet* for the particular XRF make, model and testing mode used, indicating that the XRF instrument was in calibration and that XRF testing could begin. (See the single-family housing example, in section A, above, of this addendum, for a description of what to do when the calibration check tolerance is exceeded.)

The inspector began XRF testing in the bedroom by taking one reading on each testing combination listed on the inventory data sheet. XRF testing continued until all concrete, wood, and plaster component types were inspected in the bedroom. The XRF readings were recorded on the "Multi-family Housing LBP Testing Data Sheet" form (Completed form 7.5). According to the XRF Performance Characteristic Sheet (PCS), the XRF instrument in use did not require correction for substrate bias for any of the substrates encountered in the development, so the XRF classification column was completed at that time. The inspector used the rules for classifying the XRF readings as positive, negative, or inconclusive. The inspector also used the inconclusive ranges obtained from the PCS (0.41 mg/cm² to 1.39 mg/cm²). The midpoint of the inconclusive range was then calculated to be 0.90 mg/cm² $[(0.41 \text{ mg/cm}^2 + 1.39 \text{ mg/cm}^2)/2 = 0.90 \text{ mg/cm}^2]$. The results of the classifications were recorded in the Classification column of the "Multi-family Housing LBP Testing Data Sheet" form. Classifications for all testing combinations within the unit were computed in the same manner as for the bedroom.

Once inspections were completed in all of the 35 selected units of the development, the inspector completed the "Multi-family Housing: Component Type Report" form (Completed Form 7.6). A description of each component type was recorded in the first column, the total number of each tested component type was entered in the second column, and the number of testing combinations classified as positive for each component type from the "Multi-family Housing LBP Testing Data Sheet" (Completed Form 7.5) was calculated and entered in the third column. The inspector then did the same for the testing combinations classified as negative, that is, XRF readings up to and including 0.40 mg/cm², and for inconclusive classifications with XRF readings less than the midpoint of the inconclusive range, that is, XRF readings from 0.41 mg/cm² to 0.89 mg/cm², and for inconclusive classifications with XRF readings equal to or greater than the mid-point of the inconclusive range, that is 0.90 mg/cm² to 1.39 mg/cm². Using these readings and the total number of the component type sampled, the inspector computed and recorded the percentages of positive, negative, and inconclusive classifications for each component type.

After entering the number of testing combinations for each component type in the “Multi-family Housing Component Type Report” form, the inspector noticed that only 34 wood door casings had been inspected. Because it is necessary to test at least 40 testing combinations of each component type, the inspector arranged with the client to test six more previously untested door casings. Additional units were randomly selected from the list of unsampled units. An initial calibration check test was successfully completed and the six door casings were tested for lead-based paint. Another calibration check test indicated that the XRF instrument remained within acceptable limits. The inspector then updated the “Multi-family Housing: Component Type Report” form by crossing out with one line the row of the form that showed the original, insufficient number of component types for testing; the inspector then wrote the information on the full 40 wood door casings in a new row.

The inspector used the “Multi-family Decision Flowchart” (figure 7.3) to evaluate the component type results. Because 100 percent of the plaster walls and metal baseboards tested negative for lead, the inspector concluded that no lead-based paint had been detected on any plaster walls or metal baseboards in the development, including those in uninspected units, and entered “NEG” in the Overall Classification column. The inspector also observed that shelves, hall cabinets, and window casings had no positive results. For all of the other component types, 15% or more of the readings for each type were positive; after choosing *not* to perform additional XRF readings or laboratory analysis on those components, that is, to rely on the XRF readings, the inspector entered “POS” in the Overall Classification column for them. For the shelves, all the XRF results were negative or inconclusive and less than 0.90 mg/cm² (“low inconclusive”) so the inspector, in accordance with the flowchart, entered “NEG” in the Overall Classification column. The hall cabinets and window casings were classified as inconclusive with some readings greater than or equal to 0.90 mg/cm² (“high inconclusive”). The inspector determined that over 15 percent of the readings taken on these component types were high inconclusives. The inspector chose to take additional samples for laboratory analysis, to see if any or all of the samples would be determined to be negative by laboratory analysis.

The inspector collected paint-chip samples from the inconclusive component types, but only from testing combinations where XRF readings were equal to or greater than 0.90 mg/cm², the midpoint of the inconclusive range. Paint-chip samples were taken from 32 sampling locations: 12 hall cabinets, 7 window casings and 13 metal radiators. The paint-chip samples were collected from a 4-square-inch (25 square-centimeter) surface area on each component. Each paint-chip sample was placed in a hard-shelled plastic container, sealed, given a uniquely-numbered label, and sent to the laboratory for analysis. A chain of custody form describing the samples was included in the submission. When she completed entering the information on the form, and turned off and stored her equipment, the inspector noted the date and ending time of the inspection in her field notes.

The laboratory returned the results to the inspector, who entered the laboratory results and classifications on the appropriate “Multi-family Housing LBP Testing Data Sheet” (Form 7.5). Laboratory results of all 7 paint-chip samples taken from the window casings were classified as negative. The laboratory results of 5 samples from the hall cabinets were classified as positive, and 7 as negative. The metal radiator results were classified as 9 positives and 4 negatives.

The “Multi-family Decision Flowchart” was applied to the results shown in the “Multi-family Housing: Component Type Report” to determine the appropriate classification for each component type. The inspector classified all shelves and window casings as negative, based either on the XRF substrate-corrected readings and the laboratory confirmation analysis, respectively. Therefore,

no further lead-based paint testing was required for the shelves and window casings. About 9.1 percent (none positive by XRF analysis and 5 positive by lab analysis of the 55 that were inspected) of all hall cabinets in the housing development had lead-based paint. About 70 percent of the metal radiator paint chips were positive by lab analysis.

Final decisions made by the development client regarding the hall cabinets and radiators that have some lead-based paint were based on various factors, including:

- ◆ The substantially lower cost of inspecting all hall cabinets in the development versus replacing all of those cabinets;
- ◆ The higher cost but shorter time frame to strip or replace radiators without testing versus testing and only treating radiators with lead-based paint;
- ◆ Future plans, including renovating the buildings within three years; and
- ◆ The HUD/EPA disclosure rule requirements regarding the sale or rental of housing with lead-based paint.

In this case, the client chose to remove the positive and untested radiators to be stripped offsite and reinstalled. The client also arranged for testing hall cabinets in all of the unsampled units to determine which were positive, and which were negative. To verify the accuracy of the inspection services, the client asked the inspector to retest 10 testing combinations. The retest was performed according to instructions obtained from the *XRF Performance Characteristic Sheet*. The client appointed an employee to randomly select 10 testing combinations from the inventory list of 2 randomly selected units. The employee observed the inspector retesting the 10 selected testing combinations, using the same XRF instrument and procedures used for the initial inspection. A single XRF reading was taken from each of the 10 testing combinations. The average of the 10 repeat XRF results was calculated to be 0.674 mg/cm², and the average of the 10 previous XRF results was computed to be 0.872 mg/cm². The absolute difference between the two averages was computed to be 0.198 mg/cm² (0.872 mg/cm² minus 0.674 mg/cm²). The Retest Tolerance Limit, using the formula described in the *XRF Performance Characteristic Sheet* for the particular XRF make, model and testing mode used, was computed to be 0.231. Because 0.198 mg/cm² is less than 0.231 mg/cm², the inspector concluded that the inspection had been performed competently. The final summary report also included the address of the inspected units, the date(s) of inspection, the starting and ending times for each inspected unit, and other information described in section V.I of chapter 7.

At the end of the work shift, the inspector took a final set of three calibration check readings using the same procedure as for the initial calibration check. The following readings were obtained: 0.86, 1.07 and 0.94 mg/cm². The average of these readings is 0.97 mg/cm². The difference between 0.97 mg/cm² and the NIST SRM's 1.02 mg/cm² is -0.08 mg/cm², which is not greater in magnitude than the 0.30 mg/cm² calibration check tolerance for the instrument used. The inspector recorded that the XRF instrument was in calibration, and that the measurements taken between the first and second calibrations could be used.

Addendum 2:

Data Collection Forms

1. Single Family Housing LBP Testing Data Sheet (Form 7.1) – Blank
2. Single Family Housing LBP Testing Data Sheet (Form 7.1) – Completed
3. Calibration Check Test Results (Form 7.2) – Blank
4. Calibration Check Test Results (Form 7.2) – Completed
5. Substrate Correction Values (Form 7.3) – Blank
6. Substrate Correction Values (Form 7.3) – Completed
7. Selection of Housing Units (Form 7.4) – Blank
8. Selection of Housing Units (Form 7.4) – Completed
9. Multi-family Housing LBP Testing Data Sheet (Form 7.5) – Blank
10. Multi-family Housing LBP Testing Data Sheet (Form 7.5) – Completed
11. Multi-family Housing: Component Type Report (Form 7.6) – Blank
12. Multi-family Housing: Component Type Report (Form 7.6) – Completed

Single-Family Housing LBP Testing Data Sheet

Address/Unit No. _____ Date _____

Room Equivalent _____

XRF Serial No. _____ Inspector Name _____ Signature _____

Sample ID#	Substrate	Component	Color	Test Locations	XRF Reading	Correction Value	Result	Classification (pos, neg, inc)	Laboratory Result	UNITS	Final Classification
										mg/cm ²	
										%	
										mg/cm ²	
										%	
										mg/cm ²	
										%	
										mg/cm ²	
										%	
										mg/cm ²	
										%	
										mg/cm ²	
										%	
										mg/cm ²	
										%	
										mg/cm ²	
										%	
										mg/cm ²	
										%	
										mg/cm ²	
										%	
										mg/cm ²	
										%	
										mg/cm ²	
										%	
										mg/cm ²	
										%	
										mg/cm ²	
										%	
										mg/cm ²	
										%	

Single-Family and Multifamily Testing LBP Testing Data Sheet

Address/Unit No. 918 Fenway Drive

Date August 19, 2012

Room Equivalent Bedroom 1 (Room 5)

XRF Serial No. RS-1967 Inspector Name Mr. Smith Signature Mo Smith

Sample ID#	Substrate	Component	Replication Number**	Test Locations*	XRF Reading	Correction Value	Result	Classification (pos, neg, inc)	Laboratory Result	Choose units	Final* Classification (pos or neg)
819.1	Plaster	Wall	5	Wall A Center	1.12 mg/cm ²	NA	1.12 mg/cm ²	POS		mg/cm ²	
819.2	Plaster	Wall	5	Wall B Left	0.92 mg/cm ²	NA	0.92 mg/cm ²	NEG		mg/cm ²	POS
819.3	Plaster	Wall	5	Wall C Right	1.31 mg/cm ²	NA	1.31 mg/cm ²	POS		mg/cm ²	
819.4	Plaster	Wall	5	Wall D Right	1.12 mg/cm ²	NA	1.12 mg/cm ²	POS		mg/cm ²	
819.5	Drywall	Wall	4	Closet Wall A	1.81 mg/cm ²	NA	1.81 mg/cm ²	POS		mg/cm ²	
819.6	Drywall	Wall	4	Closet Wall B	1.62 mg/cm ²	NA	1.62 mg/cm ²	POS		mg/cm ²	
819.7	Drywall	Wall	4	Closet Wall C	2.11 mg/cm ²	NA	2.11 mg/cm ²	POS		mg/cm ²	
819.8	Drywall	Wall	4	Closet Wall D	1.85 mg/cm ²	NA	1.85 mg/cm ²	POS		mg/cm ²	
819.9	Wood	Window Sill	3	Wall C Left	2.23 mg/cm ²	NA	2.23 mg/cm ²	POS		mg/cm ²	
819.10	Wood	Window Sash	3	Wall C Left	2.40 mg/cm ²	NA	2.40 mg/cm ²	POS		mg/cm ²	
819.11	Wood	Door	2	Wall A Center	4.20 mg/cm ²	NA	4.20 mg/cm ²	POS		mg/cm ²	
819.12	Metal	Door Frame	2	Wall A Center	5.50 mg/cm ²	NA	5.50 mg/cm ²	POS		mg/cm ²	
819.13	Wood	Baseboard	4	Wall D Right	>9.9 mg/cm ²	NA	>9.9 mg/cm ²	POS		mg/cm ²	
819.14	Wood	Chair rail	1	Wall B Center	1.0 mg/cm ²	NA	1.0 mg/cm ²	INC	5400	mg/cm ²	POS
<p>While one wall (sample 819.2) was determined to be negative by XRF, the walls as a whole in this room are classified as positive because of the variability in painted surfaces due to patching and repairs has the average lead loading be 1.12 mg/cm²; specifically, (1.12 + 0.92 + 1.31 + 1.12)/4 = 1.12, which is at least 1.0.</p> <p>Sample 819.14 was inconclusive, for this XRF, at 1.0 mg/cm². Laboratory testing confirmed LBP, with the paint concentration being at least 5000 ppm.</p>											

* Maintain a complete inventory of surfaces, components or rooms that are not tested. Use CPT=Carpeted floor; ED=Entry Denied; IN=Inaccessible; NC=Not Coated/Painted surface
 ** No. of Replications: The number of times a specific room equivalent, component, substrate, and color combination occurs. For example, if four walls are characterized by the same testing combination, the number of replications would be four.

Calibration Check Test Results

Page ____ of ____

Address/Unit No. _____

Device _____

Date _____ XRF Serial No. _____

Contractor _____

Inspector Name _____ Signature _____

NIST SRM Used _____ mg/cm² Calibration Check Tolerance Used _____ mg/cm²

First Calibration Check

NIST SRM			First Average	Difference Between First Average and NIST SRM*
First Reading	Second Reading	Third Reading		

Second Calibration Check

NIST SRM			Second Average	Difference Between Second Average and NIST SRM*
First Reading	Second Reading	Third Reading		

Third Calibration Check (if required)

NIST SRM			Third Average	Difference Between Third Average and NIST SRM*
First Reading	Second Reading	Third Reading		

Fourth Calibration Check (if required)

NIST SRM			Fourth Average	Difference Between Fourth Average and NIST SRM*
First Reading	Second Reading	Third Reading		

* If the difference of the Calibration Check Average from the NIST SRM film value is greater than the specified Calibration Check Tolerance for this device, consult the manufacturer's recommendations to bring the instrument back into control. Retest all testing combinations tested since the last successful Calibration Check test.

Calibration Check Test Results

Address/Unit No. Fenway Gardens Housing Complex
Oldtown, Maryland 21334

Device WXY Company, Inc. XRF 2.1

Date August 19, 2012 XRF Serial No. RS-1967

Contractor RIGAH PG Testing, Inc

Inspector Name Mo Smith Signature Mo Smith

NIST SRM Used 1.02 mg/cm² Calibration Check Tolerance Used mg/cm²

First Calibration Check Initial reading 8:43 AM

NIST SRM			First Average	Difference Between First Average and NIST SRM*
First Reading	Second Reading	Third Reading		
1.12	1.00	1.08	1.07	0.05

Second Calibration Check Midday Reading 11:35 AM

NIST SRM			Second Average	Difference Between Second Average and NIST SRM*
First Reading	Second Reading	Third Reading		
0.86	1.07	0.89	0.94	-0.08

Third Calibration Check (if required) End of testing 2:22 PM

NIST SRM			Third Average	Difference Between Third Average and NIST SRM*
First Reading	Second Reading	Third Reading		
1.45	1.21	1.10	1.25	0.23

Failed Calibration Check

Fourth Calibration Check (if required)

NIST SRM			Fourth Average	Difference Between Fourth Average and NIST SRM*
First Reading	Second Reading	Third Reading		

* If the difference of the Calibration Check Average from the NIST SRM film value is greater than the specified Calibration Check Tolerance for this device, consult the manufacturer's recommendations to bring the instrument back into control. Retest all testing combinations tested since the last successful Calibration Check test.

Substrate Correction Values

Page _____ of _____

Address/Unit No. _____

Date _____ XRF Serial No. _____

Inspector Name _____ Signature _____

Use this form when the *XRF Performance Characteristics Sheet* indicates that correction for substrate bias is needed.

Substrate		Brick	Concrete	Drywall	Metal	Plaster	Wood
L O C A T I O N	1	First Reading					
		Second Reading					
		Third Reading					
	2	First Reading					
		Second Reading					
		Third Reading					
Correction Value (Average of the Six Readings)							

Transfer Correction Value for each substrate to the 'Correction Value' column of the LBP Testing Data Sheet.

Notes:

Substrate Correction Values

Page 3 of 6

Address/Unit No. 918 Fenway Drive
Oldtown, Maryland 21334

Date August 19, 2012 XRF Serial No. RS-1967

Inspector Name Mo Smith Signature Mo Smith

Use this form when the *XRF Performance Characteristics Sheet* indicates that correction for substrate bias is needed.

Substrate		Brick	Concrete	Drywall	Metal	Plaster	Wood	
L o c a t i o n	1	First Reading			0.10			
		Second Reading			0.09			
		Third Reading			0.09			
	2	First Reading				0.10		
		Second Reading				0.09		
		Third Reading				0.11		
Correction Value (Average of the Six Readings)					0.10			

Transfer Correction Value for each substrate to the 'Correction Value' column of the LBP Testing Data Sheet.

Notes: Metal: Location 1 - Door frame, Side B, Room 2 (Dining room)
Location 2 - Door Frame, Side C, Room 3 (Kitchen)

Selection of Housing Units

Page _____ of _____

Testing Site _____ Year Built _____ Date _____

Inspector Name _____ Signature _____

Number of Distinct Units
to be Sampled

Total Number of Units	Random Number*	Random Number times Total Number of Units #	Round up for Unit Number to be Sampled	Distinct Unit Number

* Obtain from a hand-held calculator, spreadsheet or database.
 # Round down to 1 decimal place (e.g., 23.7), except if x.0+ or x.9+, then round down to 2 decimal places (e.g., 47.02 or 34.98).

Selection of Housing Units

Testing Site Fenway Gardens Housing Complex Year Built 1962 Date August 16, 2012

Inspector Name Mo Smith

Signature Mo Smith

Number of Distinct Units to be Sampled 22

Total Number of Units	Random Number*	Random Number times Total Number of Units #	Round up for Unit Number to be Sampled	Distinct Unit Number
55	0.583	32.0	33	1
55	0.107	5.8	6	2
55	0.873	48.01	49	3
55	0.085	4.6	5	4
55	0.961	52.8	53	5
55	0.111	6.1	7	6
55	0.575	31.6	32	7
55	0.241	13.2	14	8
55	0.560	30.8	31	9
55	0.884	48.6	49	DUP
55	0.341	18.7	19	10
55	0.851	46.8	47	11
55	0.574	31.5	32	DUP
55	0.221	12.1	13	12
55	0.103	5.6	6	DUP
55	0.375	20.6	21	13
55	0.625	34.3	35	14
55	0.395	21.7	22	15
55	0.095	5.2	6	DUP
55	0.772	42.4	43	16
55	0.761	41.8	42	17
55	0.515	28.3	29	18
55	0.855	47.02	48	19
55	0.679	37.3	38	20
55	0.636	34.98	35	DUP
55	0.622	34.2	35	DUP
55	0.323	17.7	18	21
55	0.431	23.7	34	22

* Obtain from a hand-held calculator, spreadsheet or database.

Round down to 1 decimal place (e.g., 23.7), except if x.0+or x.9+, then round down to 2 decimal places (e.g., 47.02 or 34.98).

Multifamily Housing LBP Testing Data Sheet

Address/Unit No. _____ Date _____

Room Equivalent _____

XRF Serial No. _____ Inspector Name _____ Signature _____

Sample ID#	Substrate	Component	Color	Replication Number	Test Location	XRF Reading	Correction Value	Corrected Reading	Classification (pos, neg, inc)	Laboratory Result	UNITS	Laboratory Classification
										mg/cm ²		
										%		
										mg/cm ²		
										%		
										mg/cm ²		
										%		
										mg/cm ²		
										%		
										mg/cm ²		
										%		
										mg/cm ²		
										%		
										mg/cm ²		
										%		
										mg/cm ²		
										%		
										mg/cm ²		
										%		
										mg/cm ²		
										%		
										mg/cm ²		
										%		
										mg/cm ²		
										%		
										mg/cm ²		
										%		
										mg/cm ²		
										%		
										mg/cm ²		
										%		
										mg/cm ²		
										%		
										mg/cm ²		
										%		
										mg/cm ²		
										%		
										mg/cm ²		
										%		

Single-Family and Multifamily Testing LBP Testing Data Sheet

Address/Unit No. 918 Fenway Drive Date August 19, 2012
 Room Equivalent Bedroom 1 (Room 5)

XRF Serial No. RS-1967 Inspector Name Mo Smith Signature Mo Smith

Sample ID#	Substrate	Component	Replication Number**	Test Locations*	XRF Reading	Correction Value	Result	Classification (pos, neg, inc)	Laboratory Result	Choose units	Final* Classification (pos or neg)
819.1	Plaster	Wall	5	Wall A Center	1.12 mg/cm ²	NA	1.12 mg/cm ²	POS		mg/cm ²	
819.2	Plaster	Wall	5	Wall B Left	0.92 mg/cm ²	NA	0.92 mg/cm ²	NEG		mg/cm ²	POS
819.3	Plaster	Wall	5	Wall C Right	1.31 mg/cm ²	NA	1.31 mg/cm ²	POS		mg/cm ²	
819.4	Plaster	Wall	5	Wall D Right	1.12 mg/cm ²	NA	1.12 mg/cm ²	POS		mg/cm ²	
819.5	Drywall	Wall	4	Closet Wall A	1.81 mg/cm ²	NA	1.81 mg/cm ²	POS		mg/cm ²	
819.6	Drywall	Wall	4	Closet Wall B	1.62 mg/cm ²	NA	1.62 mg/cm ²	POS		mg/cm ²	
819.7	Drywall	Wall	4	Closet Wall C	2.11 mg/cm ²	NA	2.11 mg/cm ²	POS		mg/cm ²	
819.8	Drywall	Wall	4	Closet Wall D	1.85 mg/cm ²	NA	1.85 mg/cm ²	POS		mg/cm ²	
819.9	Wood	Window Sill	3	Wall C Left	2.23 mg/cm ²	NA	2.23 mg/cm ²	POS		mg/cm ²	
819.10	Wood	Window Sash	3	Wall C Left	2.40 mg/cm ²	NA	2.40 mg/cm ²	POS		mg/cm ²	
819.11	Wood	Door	2	Wall A Center	4.20 mg/cm ²	NA	4.20 mg/cm ²	POS		mg/cm ²	
819.12	Metal	Door Frame	2	Wall A Center	5.50 mg/cm ²	NA	5.50 mg/cm ²	POS		mg/cm ²	
819.13	Wood	Baseboard	4	Wall D Right	>9.9 mg/cm ²	NA	>9.9 mg/cm ²	POS		mg/cm ²	
819.14	Wood	Chair rail	1	Wall B Center	1.0 mg/cm ²	NA	1.0 mg/cm ²	INC	5400	mg/cm ²	POS
	<p>While one wall (sample 819.2) was determined to be negative by XRF, the walls as a whole in this room are classified as positive because of the variability in painted surfaces due to patching and repairs has the average lead loading be 1.12 mg/cm²; specifically, (1.12 + 0.92 + 1.31 + 1.12)/4 = 1.12, which is at least 1.0.</p> <p>Sample 819.14 was inconclusive, for this XRF, at 1.0 mg/cm². Laboratory testing confirmed LBP, with the paint concentration being at least 5000 ppm.</p>										

* Maintain a complete inventory of surfaces, components or rooms that are not tested. Use CPT=Carpeted floor; ED=Entry Denied; IN=Inaccessible; NC=Not Coated/Painted surface
 ** No. of Replications: The number of times a specific room equivalent, component, substrate, and color combination occurs. For example, if four walls are characterized by the same testing combination, the number of replications would be four.

Multifamily Housing: Component Type Report

Page ____ of ____

Address/Unit No. _____

Date _____ XRF Serial No. _____

Inspector Name _____ Signature _____

Description	Number of Readings	POSITIVE		INCONCLUSIVE*				NEGATIVE		Comp. Type Classif.
		Number	Percent	Low		High		Number	Percent	
				Number	Percent	Number	Percent			

1997 Revision

Form 7.6

* Lower Boundary: _____ Upper Boundary: _____ Midpoint: _____

Multifamily Housing: Component Type Report

Address/Unit No. Fenway Gardens Housing Complex

Date August 19, 2012 XRF Serial No. RS-1967

Inspector Name Mo-Smith Signature Mo Smith

Description	Number of Readings	POSITIVE		INCONCLUSIVE*				NEGATIVE		Comp. Type Classification
		Number	Percent	Low		High		Number	Percent	
				Number	Percent	Number	Percent			
Wood Shelves	83	4	4.8	5	6.0	9	10.8	65	78.3	NEG
Wood Doors	110	40	36.4	12	10.9	8	7.3	50	45.5	POS
Wood door Casings	34	6	17.6	5	14.7	5	14.7	18	52.9	POS
Wood Hall Cabinets	60	5	8.3	8	13.3	12	20.0	35	58.3	POS
Wood Window Stools	110	60	54.4	30	27.3	10	9.1	10	9.1	POS
Wood Window Casings	63	0	0.0	0	0.0	0	0.0	63	100	NEG
Plaster Walls	110	0	0.0	10	9.1	9	8.2	91	82.7	NEG
Concrete Support Columns	40	40	100	0	0.0	0	0.0	0	0.0	POS
Concrete Ceiling Beams	40	40	100	0	0.0	0	0.0	0	0.0	POS
Metal Baseboards	45	0	0.0	0	0.0	0	0.0	45	100	NEG
Metal Gutters	50	20	40.0	8	16.0	2	4.0	20	40.0	POS
Brick Stairway	50	10	20.0	4	8.0	6	12.0	30	60.0	POS
Metal Radiators*	55	0	0.0	11	20.0	13	23.6	31	56.4	POS
Wood Door Casings	40	12	30.0	5	12.5	5	12.5	18	45.0	POS
Metal Radiators* Retest of high inconclusive	13	9	69.2					4	30.7	POS



Addendum 3: XRF Performance Characteristics Sheets

For current XRF Performance Characteristics Sheets, see the HUD website at: <http://www.hud.gov/offices/lead/guidelines/hudguidelines/Allpcs.pdf>.

Performance Characteristic Sheet

EFFECTIVE DATE: October 7, 1996

EDITION NO.: 3

MANUFACTURER AND MODEL :

Make: *Advanced Detectors, Inc.*
Model: *LeadStar*
Source: ⁵⁷Co
Note: This sheet supersedes all previous sheets for the XRF instrument of the make, model, and source shown above.

FIELD OPERATION GUIDANCE

OPERATING PARAMETERS

Nominal Reading Time is 15 seconds Fixed mode; or Brief mode.

XRF CALIBRATION CHECK LIMITS

For this instrument, calibration check readings should be taken in *Fixed Mode*.

Instruments with software versions 4.1 to 4.30*
0.83 to 1.02 mg/cm ² (inclusive)
* This guidance may be used for software versions higher than 4.30 if the higher software version incorporates the same signal processing and data treatment algorithms that are in software version 4.30

Instruments with software versions earlier than version 4.1
0.83 to 1.12 mg/cm ² (inclusive)

(Operators may choose to use limits in the manufacturer's operations manual for this calibration check. The rate of an incorrect result if the limits in the manufacturer's operations manual are followed may be different from the rate of an incorrect result stated here.)

SUBSTRATE CORRECTION:

Substrate correction recommended for XRF results below 4.0 mg/cm²:

For those instruments with software versions 4.1 to 4.30 (this guidance may be used for software versions higher than 4.30 if the higher software version incorporates the same signal processing and data treatment algorithms that are in software version 4.30):

None

For those instruments with software versions earlier than version 4.1 :

Metal

Substrate correction not recommended for:

For those instruments with software versions 4.1 to 4.30:

Brick, Concrete, Drywall, Metal, Plaster, and Wood

For those instruments with software versions earlier than version 4.1:

Brick, Concrete, Drywall, Plaster, and Wood

INCONCLUSIVE RANGE OR THRESHOLD

For those instruments with software versions 4.1 to 4.30 (this guidance may be used for software versions higher than 4.30 if the higher software version incorporates the same signal processing and data treatment algorithms that are in software version 4.30):

15-SECOND FIXED MODE READING DESCRIPTION	SUBSTRATE	THRESHOLD (mg/cm ²)	INCONCLUSIVE RANGE (mg/cm ²)
Results not corrected for substrate bias	Brick	None	0.91 to 1.09
	Concrete	None	0.91 to 1.09
	Drywall	None	0.91 to 1.09
	Metal	None	0.91 to 1.19
	Plaster	1.0	None
	Wood	None	0.91 to 1.09

BRIEF MODE READING DESCRIPTION	SUBSTRATE	THRESHOLD in mg/cm ²
Results not corrected for substrate bias	Brick	1.0
	Concrete	1.0
	Drywall	1.0
	Metal	1.0
	Plaster	1.0
	Wood	1.0

For those instruments with software versions earlier than version 4.1:

15-SECOND FIXED MODE READING DESCRIPTION	SUBSTRATE	INCONCLUSIVE RANGE in mg/cm ²
Results corrected for substrate bias for readings on metal substrates only	Brick	0.91 to 1.29
	Concrete	0.91 to 1.29
	Drywall	0.91 to 1.09
	Metal	0.91 to 1.09
	Plaster	0.91 to 1.09
	Wood	0.91 to 1.09

BACKGROUND INFORMATION

EVALUATION DATA SOURCE AND DATE

This sheet is supplemental information to be used in conjunction with Chapter 7 of the HUD *Guidelines for the Evaluation and Control of Lead-Based Paint Hazards in Housing* ("HUD Guidelines"). Performance parameters shown on this sheet are calculated from evaluation data collected during the EPA/HUD field evaluation study conducted from March through October 1993. The data were collected from four instruments at approximately 1,200 15-second test locations and 300 60-second test locations. One instrument had a January 1993 source and the other three instruments had July 1993 sources. All four instruments had sources with 40 mCi initial strengths. The results of this study are reported in *A Field Test of Lead-Based Paint Testing Technologies: Technical Report*, EPA 747-R-95-002b, May 1995.

OPERATING PARAMETERS

Performance parameters shown in this sheet are applicable only when properly operating the instrument using the manufacturer's instructions and procedures described in Chapter 7 of the HUD Guidelines.

XRF CALIBRATION CHECK:

The calibration of the XRF instrument should be checked using the paint film nearest 1.0 mg/cm² in the NIST Standard Reference Material (SRM) used (e.g., for NIST SRM 2579, use the 1.02 mg/cm² film).

If readings are outside the acceptable calibration check range, follow the manufacturer's instructions to bring the instruments into control before XRF testing proceeds

SUBSTRATE CORRECTION VALUE COMPUTATION

Chapter 7 of the HUD Guidelines provides guidance on correcting XRF results for substrate bias. Supplemental guidance for using the paint film nearest 1.0 mg/cm² for substrate correction is provided:

XRF results are corrected for substrate bias by subtracting from each XRF result a correction value determined separately in each house for single-family housing or in each development for multifamily housing, for each substrate. The correction value is an average of XRF readings taken over the NIST SRM paint film nearest to 1.0 mg/cm² at test locations that have been scraped bare of their paint covering. Compute the correction values as follows:

- Using the same XRF instrument, take three readings on a bare substrate area covered with the NIST SRM paint film nearest 1 mg/cm². Repeat this procedure by taking three more readings on a second bare substrate area of the same substrate covered with the NIST SRM.
- Compute the correction value for each substrate type where XRF readings indicate substrate correction is needed by computing the average of all six readings as shown below.

For each substrate type (the 1.02 mg/cm² NIST SRM is shown in this example; use the actual lead loading of the NIST SRM used for substrate correction):

$$\left. \begin{array}{l} \text{Correction} \\ \text{Value} \end{array} \right\} = \frac{1^{st} + 2^{nd} + 3^{rd} + 4^{th} + 5^{th} + 6^{th} \text{ Reading}}{6} - 1.02\text{mg/cm}^2$$

- Repeat this procedure for each substrate requiring substrate correction in the house or housing development.

EVALUATING THE QUALITY OF XRF TESTING

Randomly select ten testing combinations for retesting from each house or from two randomly selected units in multifamily housing. Use either 15-second readings or 60-second readings.

Conduct XRF retesting at the ten testing combinations selected for retesting.

Determine if the XRF testing in the units or house passed or failed the test by applying the steps below.

Compute the Retest Tolerance Limit by the following steps:

Determine XRF results for the original and retest XRF readings. Do not correct the original or retest results for substrate bias. In single-family and multi-family housing, a result is defined as a single

reading. Therefore, there will be ten original and ten retest XRF results for each house or for the two selected units.

Calculate the average of the original XRF result and retest XRF result for each testing combination.

Square the average for each testing combination.

Add the ten squared averages together. Call this quantity C.

Multiply the number C by 0.0072. Call this quantity D.

Add the number 0.032 to D. Call this quantity E.

Take the square root of E. Call this quantity F.

Multiply F by 1.645. The result is the Retest Tolerance Limit.

Compute the average of all ten original XRF results.

Compute the average of all ten retest XRF results.

Find the absolute difference of the two averages.

If the difference is less than the Retest Tolerance Limit, the inspection has passed the retest. If the difference of the overall averages equals or exceeds the Retest Tolerance Limit, this procedure should be repeated with ten new testing combinations. If the difference of the overall averages is equal to or greater than the Retest Tolerance Limit a second time, then the inspection should be considered deficient.

Use of this procedure is estimated to produce a spurious result approximately 1% of the time. That is, results of this procedure will call for further examination when no examination is warranted in approximately 1 out of 100 dwelling units tested.

TESTING TIMES:

For *Fixed Mode*, the LeadStar instrument tests for a set length of time before a result is obtained and displayed. For *Brief Mode*, the LeadStar instrument tests until a reading is obtained relative to an operator set *Action Level*. The following table provides a summary of testing times for readings taken in *Brief Mode* with an *Action Level* set to 1.0 mg/cm². All times have been scaled relative to an initial source strength of 15 mCi. Note that source strength and factors such as substrate may affect testing times.

Results from testing in August 1996 and September 1996

BRIEF MODE TESTING TIMES (Seconds)						
SUBSTRATE	ALL DATA			MEDIAN FOR LABORATORY-MEASURED LEAD LEVELS (mg/cm ²)		
	25 th Percentile	Median	75 th Percentile	Pb < 0.25	0.25 ≤ Pb < 1.0	1.0 ≤ Pb
Wood Drywall	7	7	8	7	8	7
Metal	7	7	8	7	8	7
Brick Concrete Plaster	8	8	9	8	8	8

*Testing times are based on readings obtained relative to a 1.0 mg/cm² Action Level.

BIAS AND PRECISION

Do not use these bias and precision data to correct for substrate bias. These bias and precision data were computed without substrate correction from samples with reported laboratory results less than 4.0 mg/cm² lead. There were 15 test locations taken in *Fixed Mode* with a laboratory reported result equal to or greater than 4.0 mg/cm² lead. The fifteen test locations were each tested four times in *Fixed Mode*, once under software version 4.05, once under software version 4.08, and twice under software version 4.30. Of the 15 test locations tested under software version 4.05, one case resulted in an XRF reading was less than 1.0 mg/cm². Of the 45 test locations tested under software versions 4.08 and 4.30, there were no instances in which an XRF reading was less than 1.0 mg/cm². Each of the fifteen test locations were tested in *Brief Mode* twice, both under software version 4.30. Out of the 30 *Brief Mode* testing cases, there were no instances in which an XRF reading was less than 1.0 mg/cm². The following data are for illustrative purposes only. Actual bias must be determined on-site. Inconclusive ranges provided above already account for bias and precision.

For those instruments with software versions 4.1 to 4.30.

FIXED MODE READINGS MEASURED AT	SUBSTRATE	BIAS (mg/cm ²)	PRECISION ¹ (mg/cm ²)
0.0 mg/cm ²	Brick	0.0	0.1
	Concrete	0.0	0.1
	Drywall	0.0	0.1
	Metal	0.1	0.1
	Plaster	-0.1	0.1
	Wood	0.0	0.1
0.5 mg/cm ²	Brick	0.1	0.2
	Concrete	0.1	0.2
	Drywall	0.0	0.2
	Metal	0.1	0.2
	Plaster	0.0	0.2
	Wood	0.1	0.2
1.0 mg/cm ²	Brick	0.1	0.3
	Concrete	0.1	0.3
	Drywall	0.1	0.3
	Metal	0.2	0.3
	Plaster	0.0	0.3
	Wood	0.1	0.3
2.0 mg/cm ²	Brick	0.2	0.4
	Concrete	0.2	0.4
	Drywall	0.2	0.4
	Metal	0.3	0.4
	Plaster	0.1	0.4
	Wood	0.2	0.4

¹Precision at 1 standard deviation

For those instruments with software versions earlier than version 4.1.

FIXED MODE READINGS MEASURED AT	SUBSTRATE	BIAS (mg/cm ²)	PRECISION ¹ (mg/cm ²)
0.0 mg/cm ²	Brick	0.1	0.1
	Concrete	0.1	0.1
	Drywall	0.0	0.1
	Metal	0.1	0.1
	Plaster	0.0	0.1
	Wood	0.0	0.1
0.5 mg/cm ²	Brick	0.2	0.2
	Concrete	0.2	0.2
	Drywall	0.1	0.2
	Metal	0.2	0.2
	Plaster	0.1	0.2
	Wood	0.1	0.2
1.0 mg/cm ²	Brick	0.3	0.3
	Concrete	0.3	0.3
	Drywall	0.1	0.3
	Metal	0.2	0.3
	Plaster	0.1	0.3
	Wood	0.1	0.3
2.0 mg/cm ²	Brick	0.4	0.5
	Concrete	0.4	0.5
	Drywall	0.3	0.5
	Metal	0.4	0.5
	Plaster	0.3	0.5
	Wood	0.3	0.5

¹Precision at 1 standard deviation

CLASSIFICATION OF RESULTS

XRF results are classified as positive if they are greater than the upper boundary of the inconclusive range, and negative if they are less than the lower boundary of the inconclusive range, or inconclusive if in between. The inconclusive range includes both its upper and lower bounds. Earlier editions of this *XRF Performance Characteristics Sheet* did not include both bounds of the inconclusive range as "inconclusive." While this edition of the Performance Characteristics Sheet uses a different system, the specific XRF readings that are considered positive, negative, or inconclusive for a given XRF model and substrate remain unchanged, so previous inspection results are not affected.

DOCUMENTATION

A document titled *Methodology for XRF Performance Characteristic Sheets* provides an explanation of the statistical methodology used to construct the data in the sheets, and provides empirical results from using the recommended inconclusive ranges or thresholds for specific XRF instruments. For a copy of this document call the National Lead Information Center Clearinghouse at 1-800-424-LEAD.

This XRF Performance Characteristics Sheet is a joint product of the U.S. Environmental Protection Agency (EPA) and the U.S. Department of Housing and Urban Development (HUD). The issuance of this sheet does not constitute rulemaking. The information provided here is intended solely as guidance to be used in conjunction with Chapter 7, Lead-Based Paint Inspection, of the *Guidelines for the Evaluation and Control of Lead-Based Paint Hazards in Housing*. EPA and HUD reserve the right to revise this guidance. Please address questions and comments on this sheet to: Director, Office of Lead Hazard Control (L), U.S. Department of Housing and Urban Development, 451 Seventh St, S.W., Washington, DC 20410.

Performance Characteristic Sheet

EFFECTIVE DATE: December 1, 2006

EDITION NO.: 1

MANUFACTURER AND MODEL:

Make: *Innov-X Systems, Inc.*
 Models: *LBP4000 with software version 1.4 and higher*
 Source: *X-ray tube*

FIELD OPERATION GUIDANCE

OPERATING PARAMETERS:

Inspection mode, variable reading time.

XRF CALIBRATION CHECK LIMITS:

1.0 to 1.1 mg/cm² (inclusive)

SUBSTRATE CORRECTION:

Not applicable

INCONCLUSIVE RANGE OR THRESHOLD:

INSPECTION MODE READING DESCRIPTION	SUBSTRATE	INCONCLUSIVE RANGE (mg/cm ²)
Results not corrected for substrate bias on any substrate	Brick Concrete Drywall Metal Plaster Wood	0.6 to 1.1 0.6 to 1.1 0.6 to 1.1 0.6 to 1.1 0.6 to 1.1 0.6 to 1.1

BACKGROUND INFORMATION

EVALUATION DATA SOURCE AND DATE:

This sheet is supplemental information to be used in conjunction with Chapter 7 of the HUD *Guidelines for the Evaluation and Control of Lead-Based Paint Hazards in Housing* ("HUD Guidelines"). Performance parameters shown on this sheet are calculated from the EPA/HUD evaluation using archived building components. Testing was conducted on 146 test locations, with two separate instruments, in December 2005.

OPERATING PARAMETERS:

Performance parameters shown in this sheet are applicable only when properly operating the instrument using the manufacturer's instructions and procedures described in Chapter 7 of the HUD Guidelines.

XRF CALIBRATION CHECK:

The calibration of the XRF instrument should be checked using the paint film nearest 1.0 mg/cm² in the NIST Standard Reference Material (SRM) used (e.g., for NIST SRM 2579, use the 1.02 mg/cm² film).

If the average (rounded to 1 decimal place) of three readings is outside the acceptable calibration check range, follow the manufacturer's instructions to bring the instrument into control before XRF testing proceeds.

SUBSTRATE CORRECTION VALUE COMPUTATION:

Chapter 7 of the HUD Guidelines provides guidance on correcting XRF results for substrate bias. Supplemental guidance for using the paint film nearest 1.0 mg/cm² for substrate correction is provided:

XRF results are corrected for substrate bias by subtracting from each XRF result a correction value determined separately in each house for single-family housing or in each development for multifamily housing, for each substrate. The correction value is an average of XRF readings taken over the NIST SRM paint film nearest to 1.0 mg/cm² at test locations that have been scraped bare of their paint covering. Compute the correction values as follows:

Using the same XRF instrument, take three readings on a bare substrate area covered with the NIST SRM paint film nearest 1 mg/cm². Repeat this procedure by taking three more readings on a second bare substrate area of the same substrate covered with the NIST SRM.

Compute the correction value for each substrate type where XRF readings indicate substrate correction is needed by computing the average of all six readings as shown below.

For each substrate type (the 1.02 mg/cm² NIST SRM is shown in this example; use the actual lead loading of the NIST SRM used for substrate correction):

$$\text{Correction value} = (1\text{st} + 2\text{nd} + 3\text{rd} + 4\text{th} + 5\text{th} + 6\text{th Reading}) / 6 - 1.02 \text{ mg/cm}^2$$

Repeat this procedure for each substrate requiring substrate correction in the house or housing development.

EVALUATING THE QUALITY OF XRF TESTING:

Randomly select ten testing combinations for retesting from each house or from two randomly selected units in multifamily housing.

Conduct XRF re-testing at the ten testing combinations selected for retesting.

Determine if the XRF testing in the units or house passed or failed the test by applying the steps below.

Compute the Retest Tolerance Limit by the following steps:

Determine XRF results for the original and retest XRF readings. Do not correct the original or retest results for substrate bias. In single-family and multi-family housing, a result is defined as a single reading. Therefore, there will be ten original and ten retest XRF results for each house or for the two selected units.

Calculate the average of the original XRF result and the retest XRF result for each testing combination.

Square the average for each testing combination.

Add the ten squared averages together. Call this quantity C.

Multiply the number C by 0.0072. Call this quantity D.
 Add the number 0.032 to D. Call this quantity E.
 Take the square root of E. Call this quantity F.
 Multiply F by 1.645. The result is the Retest Tolerance Limit.

Compute the average of all ten original XRF readings.

Compute the average of all ten re-test XRF readings.

Find the absolute difference of the two averages.

If the difference is less than the Retest Tolerance Limit, the inspection has passed the retest. If the difference of the overall averages equals or exceeds the Retest Tolerance Limit, this procedure should be repeated with ten new testing combinations. If the difference of the overall averages is equal to or greater than the Retest Tolerance Limit a second time, then the inspection should be considered deficient.

Use of this procedure is estimated to produce a spurious result approximately 1% of the time. That is, results of this procedure will call for further examination when no examination is warranted in approximately 1 out of 100 dwelling units tested.

TESTING TIMES:

For the variable-time inspection paint test mode, the instrument continues to read until it has determined whether the result is positive or negative (with respect to the 1.0 mg/cm² Federal standard), with 95% confidence. The following table provides testing time information for this testing mode.

Testing Times Using Variable Reading Time Inspection Mode (Seconds)						
Substrate	All Data			Median for laboratory-measured lead levels (mg/cm ²)		
	25 th Percentile	Median	75 th Percentile	Pb < 0.25	0.25 ≤ Pb < 1.0	1.0 ≤ Pb
Wood, Drywall	2.1	2.3	5.4	2.2	5.4	2.2
Metal	2.6	3.2	5.3	2.7	5.1	5.1
Brick, Concrete, Plaster	3.1	4.0	5.7	3.2	4.0	5.9

CLASSIFICATION OF RESULTS:

When an inconclusive range is specified on the *Performance Characteristic Sheet*, XRF results are classified as positive if they are greater than the upper boundary of the inconclusive range, negative if they are less than the lower boundary of the inconclusive range, or inconclusive if in between. The inconclusive range includes both its upper and lower bounds. If the instrument reads “> x mg/cm²”, the value “x” should be used for classification purposes, ignoring the “>”. For example, a reading reported as “>1.0 mg/cm²” is classified as 1.0 mg/cm², or inconclusive. When the inconclusive range reported in this PCS is used to classify the readings obtained in the EPA/HUD evaluation, the following False Positive, False Negative and Inconclusive rates are obtained:

FALSE POSITIVE RATE: 2.5% (2/80)
 FALSE NEGATIVE RATE: 1.9% (4/212)
 INCONCLUSIVE RATE: 16.4% (48/212)

DOCUMENTATION:

A document titled *Methodology for XRF Performance Characteristic Sheets* provides an explanation of the statistical methodology used to construct the data in the sheets, and provides empirical results from using the recommended inconclusive ranges or thresholds for specific XRF instruments. For a copy of this document call the National Lead Information Center Clearinghouse at 1-800-424-LEAD.

This XRF Performance Characteristic Sheet was developed by the Midwest Research Institute (MRI) and QuanTech, Inc., under a contract between MRI and the XRF manufacturer. XRF Performance Characteristic Sheets were originally developed by the MRI under a grant from the U. S. Environmental Protection Agency and the U.S. Department of Housing and Urban Development. HUD has determined that the information provided here is acceptable when used as guidance in conjunction with Chapter 7, Lead-Based Paint Inspection, of HUD's *Guidelines for the Evaluation and Control of Lead-Based Paint Hazards in Housing*.

Performance Characteristic Sheet

EFFECTIVE DATE: September 24, 2004

EDITION NO.: 1

MANUFACTURER AND MODEL:

Make: Niton LLC

Tested Model: XLp 300

Source: ^{109}Cd

Note: This PCS is also applicable to the equivalent model variations indicated below, for the Lead-in-Paint K+L variable reading time mode, in the XLi and XLp series:

XLi 300A, XLi 301A, XLi 302A and XLi 303A.

XLp 300A, XLp 301A, XLp 302A and XLp 303A.

XLi 700A, XLi 701A, XLi 702A and XLi 703A.

XLp 700A, XLp 701A, XLp 702A and XLp 703A.

Note: The XLi and XLp versions refer to the shape of the handle part of the instrument. The differences in the model numbers reflect other modes available, in addition to Lead-in-Paint modes. The manufacturer states that specifications for these instruments are identical for the source, detector, and detector electronics relative to the Lead-in-Paint mode.

FIELD OPERATION GUIDANCE

OPERATING PARAMETERS:

Lead-in-Paint K+L variable reading time mode.

XRF CALIBRATION CHECK LIMITS:

0.8 to 1.2 mg/cm² (inclusive)

The calibration of the XRF instrument should be checked using the paint film nearest 1.0 mg/cm² in the NIST Standard Reference Material (SRM) used (e.g., for NIST SRM 2579, use the 1.02 mg/cm² film).

If readings are outside the acceptable calibration check range, follow the manufacturer's instructions to bring the instruments into control before XRF testing proceeds.

SUBSTRATE CORRECTION:

For XRF results using Lead-in-Paint K+L variable reading time mode, substrate correction is not needed for:

Brick, Concrete, Drywall, Metal, Plaster, and Wood

INCONCLUSIVE RANGE OR THRESHOLD:

K+L MODE READING DESCRIPTION	SUBSTRATE	THRESHOLD (mg/cm ²)
Results not corrected for substrate bias on any substrate	Brick	1.0
	Concrete	1.0
	Drywall	1.0
	Metal	1.0
	Plaster	1.0
	Wood	1.0

BACKGROUND INFORMATION

EVALUATION DATA SOURCE AND DATE:

This sheet is supplemental information to be used in conjunction with Chapter 7 of the HUD *Guidelines for the Evaluation and Control of Lead-Based Paint Hazards in Housing* ("HUD Guidelines"). Performance parameters shown on this sheet are calculated from the EPA/HUD evaluation using archived building components. Testing was conducted in August 2004 on 133 testing combinations. The instruments that were used to perform the testing had new sources; one instrument's was installed in November 2003 with 40 mCi initial strength, and the other's was installed June 2004 with 40 mCi initial strength.

OPERATING PARAMETERS:

Performance parameters shown in this sheet are applicable only when properly operating the instrument using the manufacturer's instructions and procedures described in Chapter 7 of the HUD Guidelines.

SUBSTRATE CORRECTION VALUE COMPUTATION:

Substrate correction is not needed for brick, concrete, drywall, metal, plaster or wood when using Lead-in-Paint K+L variable reading time mode, the normal operating mode for these instruments. If substrate correction is desired, refer to Chapter 7 of the HUD Guidelines for guidance on correcting XRF results for substrate bias.

EVALUATING THE QUALITY OF XRF TESTING:

Randomly select ten testing combinations for retesting from each house or from two randomly selected units in multifamily housing. Use the K+L variable time mode readings.

Conduct XRF retesting at the ten testing combinations selected for retesting.

Determine if the XRF testing in the units or house passed or failed the test by applying the steps below.

Compute the Retest Tolerance Limit by the following steps:

Determine XRF results for the original and retest XRF readings. Do not correct the original or retest results for substrate bias. In single-family and multifamily housing, a result is defined as a single reading. Therefore, there will be ten original and ten retest XRF results for each house or for the two selected units.

Calculate the average of the original XRF result and retest XRF result for each testing combination.

Square the average for each testing combination.

Add the ten squared averages together. Call this quantity C.

Multiply the number C by 0.0072. Call this quantity D.

Add the number 0.032 to D. Call this quantity E.

Take the square root of E. Call this quantity F.

Multiply F by 1.645. The result is the Retest Tolerance Limit.

Compute the average of all ten original XRF results.

Compute the average of all ten re-test XRF results.

Find the absolute difference of the two averages.

If the difference is less than the Retest Tolerance Limit, the inspection has passed the retest. If

the difference of the overall averages equals or exceeds the Retest Tolerance Limit, this procedure should be repeated with ten new testing combinations. If the difference of the overall averages is equal to or greater than the Retest Tolerance Limit a second time, then the inspection should be considered deficient.

Use of this procedure is estimated to produce a spurious result approximately 1% of the time. That is, results of this procedure will call for further examination when no examination is warranted in approximately 1 out of 100 dwelling units tested.

TESTING TIMES:

For the Lead-in-Paint K+L variable reading time mode, the instrument continues to read until it is moved away from the testing surface, terminated by the user, or the instrument software indicates the reading is complete. The following table provides testing time information for this testing mode. The times have been adjusted for source decay, normalized to the initial source strengths as noted above. Source strength and type of substrate will affect actual testing times. At the time of testing, the instruments had source strengths of 26.6 and 36.6 mCi.

Testing Times Using K+L Reading Mode (Seconds)						
Substrate	All Data			Median for laboratory-measured lead levels (mg/cm ²)		
	25 th Percentile	Median	75 th Percentile	Pb < 0.25	0.25 ≤ Pb < 1.0	1.0 ≤ Pb
Wood Drywall	4	11	19	11	15	11
Metal	4	12	18	9	12	14
Brick Concrete Plaster	8	16	22	15	18	16

CLASSIFICATION RESULTS:

XRF results are classified as positive if they are greater than or equal to the threshold, and negative if they are less than the threshold.

DOCUMENTATION:

A document titled *Methodology for XRF Performance Characteristic Sheets* provides an explanation of the statistical methodology used to construct the data in the sheets, and provides empirical results from using the recommended inconclusive ranges or thresholds for specific XRF instruments. For a copy of this document call the National Lead Information Center Clearinghouse at 1-800-424-LEAD.

This XRF Performance Characteristic Sheet was developed by the Midwest Research Institute (MRI) and QuanTech, Inc., under a contract between MRI and the XRF manufacturer. HUD has determined that the information provided here is acceptable when used as guidance in conjunction with Chapter 7, Lead-Based Paint Inspection, of HUD's *Guidelines for the Evaluation and Control of Lead-Based Paint Hazards in Housing*.

Performance Characteristic Sheet

EFFECTIVE DATE: April 17, 1998

EDITION NO.: 4

MANUFACTURER AND MODEL :

Make: *Niton Corporation*

Models: *XL-309, 701-A, 702-A, and 703-A Spectrum Analyzers*

Source: ^{109}Cd (10 - 40 mCi initial source strength)

Note: This Performance Characteristic Sheet (PCS) is applicable to the listed Niton XRF instruments which have an operating software version of 5.1 (or equivalent) using a variable-time mode, and to Niton instruments having an operating software version of 1.2C (or equivalent) using a fixed-time mode. This sheet supersedes all previous sheets for the XRF instruments made by the Niton Corporation and the 1993 testing of XL prototypes reported in the document titled: *A Field Test of Lead-Based Paint Testing Technologies: Technical Report* (EPA Report No. 747-R-95-002b, May 1995).

FIELD OPERATION GUIDANCE

This PCS provides supplemental information to be used in conjunction with Chapter 7 (Lead-Based Paint Inspection) of the HUD *Guidelines for the Evaluation and Control of Lead-Based Paint Hazards in Housing* ("HUD Guidelines"). Performance parameters shown in this sheet are applicable only when operating the instrument using the manufacturer's instructions and the procedures described in Chapter 7 of the HUD Guidelines.

OPERATING PARAMETERS

Use of variable-time paint test mode ("K & L + Spectra" mode) on instruments running software version 5.1 (or equivalent) using the "Combined Lead Reading" with the instrument's display of a 95%--confident (2-sigma) *Positive* or *Negative* determination versus the action-level as the stopping point of the measurement.

Use of nominal 20-second readings for L-shell results or 120-second readings for K-shell results on instruments running software version 1.2C (or equivalent) in a fixed-time mode.

XRF CALIBRATION CHECK LIMITS

0.9 to 1.2 mg/cm² (inclusive) for instruments running software version 5.1 (or equivalent)

0.9 to 1.1 mg/cm² (inclusive) for instruments running software version 1.2C (or equivalent)

SUBSTRATE CORRECTION :

(applicable to instruments running software versions 5.1 (or equivalent) or 1.2C (or equivalent))

For XRF results below 4.0 mg/cm², substrate correction recommended for:

None.

Substrate correction is not recommended for:

Brick, Concrete, Drywall, Metal, Plaster, and Wood

THRESHOLDS:**(applicable to instruments running software versions 5.1 (or equivalent) or 1.2C (or equivalent))**

DESCRIPTION	SUBSTRATE	THRESHOLD* (mg/cm ²)
Results not corrected for substrate bias	Brick	1.0
	Concrete	1.0
	Drywall	1.0
	Metal	1.0
	Plaster	1.0
	Wood	1.0
*For instruments running software version 1.2C (or equivalent), application of the decision making methodology recommended in this PCS can result in inconclusive results regardless of whether decisions are based on L-shell readings, K-shell readings, or both.		

BACKGROUND INFORMATION**EVALUATION DATA SOURCE AND DATE**

Performance parameters shown on this sheet are calculated from the EPA/HUD evaluation using archived building components. Three rounds of tests were conducted on approximately 150 test locations in each round.

One round of testing was conducted March 1995 using a single instrument with an October 1994 source at 10 mCi initial strength while running software version 1.2C in a fixed-time mode with nominal 20-second readings for L-shell results or 120-second readings for K-shell results.

The two other rounds of testing were conducted December 1997 using three different instruments, each running software version 5.1. Two of these instruments had new sources installed November 1997, the other instrument had a new source installed December 1997, all with 10 mCi initial strength. The December 1997 testing was performed in the variable-time paint test mode "K & L + Spectra" using the "Combined Lead Reading" with 2-sigma confidence interval as the stopping point of the measurement.

XRF CALIBRATION CHECK:

The calibration of the XRF instrument should be checked using the paint film nearest 1.0 mg/cm² in the NIST Standard Reference Material (SRM) (e.g., for NIST SRM 2579, use the 1.02 mg/cm² film). Measurements should be bracketed by successful XRF calibration check readings. XRF calibration checks are performed at the beginning and end of the day's inspections or at extended delays in testing, and (at least) every four hours during inspections or at a frequency recommended by the manufacturer, whichever is more stringent. If readings are outside the acceptable calibration check range, follow the manufacturer's instructions to bring the instrument into control before XRF testing proceeds. Measurements which are not bracketed by successful calibration checks should be considered suspect.

EVALUATING THE QUALITY OF XRF TESTING

Randomly select ten testing combinations for re-testing from each house or from two randomly selected units in multifamily housing. (A testing combination is a location on a painted surface as defined in Chapter 7 of the HUD Guidelines.) For testing combinations involving up to four walls in a room, each wall is classified on its individual XRF reading. (See Chapter 7 for testing procedures if there are more than four walls in a room, and for testing exterior walls.)

For instruments running software version 5.1 (or equivalent), conduct the test in the variable-time paint test mode "K & L + Spectra" using the "Combined Lead Reading" with 2-sigma confidence interval as the

stopping point of the measurement. For instruments running software version 1.2C (or equivalent) in the fixed-time mode, use either 20-second readings for the L-shell results or 120-second readings for the K-shell results, as described in the "Classifications of Results" section below.

Conduct XRF re-testing at the ten testing combinations selected for re-testing.

Determine if the XRF testing in the units or house passed or failed the test by applying the steps below.

Compute the Retest Tolerance Limit by the following steps:

Determine XRF results for the original and retest XRF readings. Do not correct the original or retest results for substrate bias. In single-family and multifamily housing, a result is defined as a single reading. Therefore, there will be ten original and ten retest XRF results for each house or for the two selected units.

Calculate the average of the original XRF result and retest XRF result for each testing combination.

Square the average for each testing combination.

Add the ten squared averages together. Call this quantity C.

Multiply the number C by 0.0072. Call this quantity D.

Add the number 0.032 to D. Call this quantity E.

Take the square root of E. Call this quantity F.

Multiply F by 1.645. The result is the Retest Tolerance Limit.

Compute the average of all ten original XRF results.

Compute the average of all ten retest XRF results.

Find the absolute difference of the two averages.

If the difference is less than the Retest Tolerance Limit, the inspection has passed the retest. If the difference of the overall averages equals or exceeds the Retest Tolerance Limit, this procedure should be repeated with ten new testing combinations. If the difference of the overall averages is equal to or greater than the Retest Tolerance Limit a second time, then the inspection should be considered deficient.

Use of this procedure is estimated to produce a spurious result approximately 1% of the time. That is, results of this procedure will call for further examination when no examination is warranted in approximately 1 out of 100 dwelling units tested.

BIAS AND PRECISION

Bias and precision data were not computed for instruments using software version 5.1 and taking variable mode readings. (See Appendix B, Section B.3.2 of the document titled *Methodology for XRF Performance Characteristic Sheets*, EPA-747-R-45-008, September 1997). During the 1997 testing, there were 12 testing locations with laboratory-measured lead levels equal to or greater than 4.0 mg/cm² lead which were tested using two instruments in the variable-time paint test mode. None of these testing locations had XRF readings less than 1.0 mg/cm². These data are for illustrative purposes only. Substrate correction is not recommended for this XRF instrument.

The bias and precision data given below are for instruments running software version 1.2C (or equivalent) and were computed without substrate correction using the 20-second L-shell readings from samples with

reported laboratory results less than 4.0 mg/cm² lead. Readings reported by the instrument in the “x” or “>x” format were not used in the computation. During the 1995 testing there were 15 test locations with a laboratory reported result equal to or greater than 4.0 mg/cm² lead. Of these, 12 readings were reported in the “>x” or “>>x” format, but of the 3 remaining, 1 had an XRF reading less than 1.0 mg/cm².

Bias & Precision Results for Niton Model XL-309 Instruments Using Software Version 1.2C (or equivalent)

MEASURED AT	SUBSTRATE	BIAS (mg/cm ²)	PRECISION* (mg/cm ²)
0.0 mg/cm ²	All	0.0	<0.1
0.5 mg/cm ²	All	0.0	0.2
1.0 mg/cm ²	All	0.0	0.3
2.0 mg/cm ²	All	-0.1	0.5

*Precision at 1 standard deviation

CLASSIFICATION OF RESULTS

This section describes how to apply information displayed by this instrument to determine the presence or absence of lead in paint using the procedures recommended in Chapter 7 of the HUD Guidelines. These guidelines recommend classifying XRF results as positive, negative, or inconclusive compared to the lead-based paint 1.0 mg/cm² standard.

For Niton Model XL-309, 701-A, 702-A, and 703-A instruments running software version 5.1 (or equivalent), XRF results are classified using a threshold. There is no inconclusive classification when using the threshold for instruments running software version 5.1. In single-family and multifamily housing, an XRF result is a single reading taken on each testing combination. (A testing combination is a location on a painted surface as defined in Chapter 7 of the HUD Guidelines.) For testing combinations involving up to four walls in a room, each wall is classified on its individual XRF reading. (See Chapter 7 for testing procedures if there are more than four walls in a room, and for testing exterior walls.) For computing the XRF result, use all digits that are displayed by the instrument as the “Combined Lead Reading.” Results are classified as positive (i.e., ≥ 1.0 mg/cm²), if greater than or equal to the threshold, or negative (< 1.0 mg/cm²) if less than the threshold. Threshold values, provided in the tables above, were determined by comparing XRF test results to the 1.0 mg/cm² standard.

For Niton Model XL-309 instruments running software version 1.2C (or equivalent), additional procedures are needed to classify readings because this software displays readings and ancillary information useful for classification purposes. An algorithmic procedure is described that makes use of the XRF reading and other displayed information.

The algorithm for classifying results is first applied to 20-second nominal L-shell readings followed by 120-second nominal K-shell readings to resolve inconclusive results, or to recommend laboratory analysis of paint-chip samples, if necessary. A listing of laboratories recognized by the EPA National Lead Laboratory Accreditation Program (NLLAP) for the confirmational analysis of inconclusive results is available from the National Lead Clearinghouse at 1-800-424-LEAD.

XRF results are classified using threshold values for the Model XL-309 software version 1.2C (or equivalent). Results are classified as positive if greater than or equal to the threshold, and as negative if less than the threshold. There is no inconclusive classification when using threshold values. However, in some cases, inconclusive results still may be obtained regardless of whether decisions are based on L-shell readings, K-shell readings, or both, as described below. Use all digits that are reported by the instrument. Threshold values, which were determined for comparing results to the 1.0 mg/cm² standard, are provided in the table above.

This instrument displays its lead-based paint measurements as both L-shell and K-shell readings based on

the corresponding L-shell and K-shell X-ray fluorescence (refer to Chapter 7 of the HUD Guidelines for more details). The L-shell readings (or L-readings) are displayed as a numerical result alone, or as a numerical result preceded by either one greater-than symbol (" $>$ ") or preceded by two greater-than symbols (" $>>$ "). The two greater-than symbols will only be displayed when the detected lead level is greater than 5.0 mg/cm^2 . Since the maximum lead level reported by this instrument is 5.0 mg/cm^2 , lead levels greater than 5.0 mg/cm^2 are displayed as " $>>5.0$ ". Other examples of how L-readings can be displayed (in mg/cm^2 units) are "0.6" and " >0.9 ". The numerical display alone implies that the instrument measured the lead in the paint at the displayed level using L-shell X-ray fluorescence; 0.6 mg/cm^2 in the example. A number preceded by a single greater-than symbol indicates that the measurable lead is deeply buried in the paint and the detected lead level is greater than the displayed value. In the example, >0.9 indicates that the instrument detected lead deeply buried in paint at a level greater than 0.9 mg/cm^2 . K-shell readings (or K-readings) are displayed in one of two ways: 1) as a single K-reading plus and minus a "precision" value or 2) as an upper K-reading and lower K-reading.

The same method is used for testing in single-family and multifamily housing. The HUD Guidelines recommend taking a single XRF reading on a testing combination. (A testing combination is a location on a painted surface as defined in Chapter 7 of the HUD Guidelines.) For testing combinations involving up to four walls in a room, each wall is classified on its individual XRF reading. (See Chapter 7 for testing procedures if there are more than four walls in a room, and for testing exterior walls.)

- A. Take a single 20-second nominal reading on each testing combination.
- B. Classify the L-reading based on the type of information displayed.

If two greater-than symbols are displayed then:

- Classify the $>>5.0$ L-reading as POSITIVE

If one greater-than symbol is displayed then:

- Classify the L-reading as POSITIVE if the numerical result that follows the greater than symbol is equal to or greater than 1.0.
- Classify the L-reading as INCONCLUSIVE if the numerical result that follows the greater than symbol is less than 1.0.

If the numerical L-reading is displayed alone (that is, without any preceding greater-than symbols) then:

- Classify the L-reading as POSITIVE if the numerical result is equal to or greater than 1.0.
- Classify the L-reading as NEGATIVE if the numerical result is less than 1.0.

- C. Resolution of results classified as inconclusive.

All results classified as inconclusive above require further investigation. Take a 120-second nominal XRF reading and use the K-shell reading. In multifamily housing, resolve the inconclusive classification with a single K-shell reading or laboratory analysis as described below.

- Classify the result as POSITIVE if either the K-reading minus the displayed precision value or the lower K-reading is equal to or greater than 1.0.
- Classify the result as NEGATIVE if either the K-reading plus the displayed precision value or the upper K-reading is less than 1.0.
- Classify the result as INCONCLUSIVE if neither of the above decision rules using the K-reading provided a classification which can occur when the upper K-reading is equal to or greater than 1.0 or the lower K-reading is less than 1.0.

- To resolve a remaining INCONCLUSIVE classification, remove a paint-chip sample as described in Chapter 7 of the HUD Guidelines and have it analyzed by a qualified laboratory as described in Chapter 7.

TESTING TIMES (FOR SOFTWARE VERSION 5.1)

For the variable-time paint test mode “K & L + Spectra,” the instrument continues measuring until a positive or negative result is indicated relative to an action level (1.0 mg/cm² for archive testing) and the current precision, or until the reading is terminated by moving the instrument away from the testing surface. None of the variable mode readings were terminated because of the two-minute limit used for archive testing. The following table provides testing time information for this testing mode. Source strength and type of substrate will affect actual testing times.

Testing Times for Instruments Running Software Version 5.1						
Variable mode testing times (seconds)						
Substrate	All data			Median for laboratory—measured lead levels (mg/cm ²)		
	25 th Percentile	Median	75 th Percentile	Pb < 0.25	0.25 <= Pb < 1.0	1.0 <= Pb
Wood Drywall	6	8	15	6	20	5
Metal	6	13	20	13	20	6
Brick Concrete Plaster	6	11	20	9	18	6

DOCUMENTATION

This PCS was developed in accordance with the methodology in the EPA report titled *Methodology for XRF Performance Characteristic Sheets* (EPA 747-R-95-008, September 1997). This report provides an explanation of the statistical methodology used to construct the data in the sheets, and provides empirical results from using the recommended inconclusive ranges or thresholds for specific XRF instruments. For a copy of this document call the National Lead Clearinghouse at 1-800-424-LEAD.

This XRF Performance Characteristic Sheet was developed by the Midwest Research Institute (MRI) under a grant from the U. S. Environmental Protection Agency and a separate contract between MRI and the XRF manufacturer. The U.S. Department of Housing and Urban Development (HUD) has determined that the information provided here is acceptable when used as guidance in conjunction with Chapter 7, Lead-Based Paint Inspection, of HUD’s *Guidelines for the Evaluation and Control of Lead-Based Paint Hazards in Housing*. While MRI reserves the right to revise this XRF Performance Characteristic Sheet at any time, HUD’s statement of acceptance would not apply to a revision until HUD has reviewed the revision and made a determination of its acceptability.

Performance Characteristic Sheet

EFFECTIVE DATE: September 25, 1995

EDITION NO.: 3

MANUFACTURER AND MODEL :

Make: *Princeton Gamma-Tech, Inc.*
Model: *XK-3*
Source: *⁵⁷Co*
Note: This sheet supersedes all previous sheets for the XRF instrument of the make, model, and source shown above.

FIELD OPERATION GUIDANCE

OPERATING PARAMETERS

Nominal Time Reading is 15 seconds.

XRF CALIBRATION CHECK LIMITS

0.5 to 2.3 mg/cm ² (inclusive)

SUBSTRATE CORRECTION:

For XRF results below 4.0 mg/cm², substrate is correction recommended for:

Brick, Concrete, Drywall, Metal, Plaster and Wood.

Substrate correction is not recommended for:

None.

INCONCLUSIVE RANGE OR THRESHOLD

DESCRIPTION	SUBSTRATE	THRESHOLD (mg/cm ²)	INCONCLUSIVE RANGE (mg/cm ²)
Readings corrected for substrate bias on all substrates	Brick	None	1.0 to 1.2
	Concrete	None	0.9 to 1.6
	Drywall	1.0	None
	Metal	None	0.4 to 1.7
	Plaster	None	0.8 to 1.3
	Wood	None	1.0 to 1.3

BACKGROUND INFORMATION

EVALUATION DATA SOURCE AND DATE

This sheet is supplemental information to be used in conjunction with Chapter 7 of the HUD *Guidelines for the Evaluation and Control of Lead-Based Paint Hazards in Housing* ("HUD Guidelines"). Performance parameters shown on this sheet are calculated from evaluation data collected during the EPA/HUD field evaluation study conducted from March through October 1993. The data were collected from approximately 1,200 test locations using three instruments. One instrument had a March 1993 source and the other two instruments had April 1993 sources. All three instruments had sources with 10 mCi initial strengths. The results of this study are reported in *A Field Test of Lead-Based Paint Testing Technologies: Technical Report*, EPA 747-R-95-002b, May 1995.

OPERATING PARAMETERS

Performance parameters shown in this sheet are applicable only when properly operating the instrument using the manufacturer's instructions and procedures described in Chapter 7 of the HUD Guidelines.

XRF CALIBRATION CHECK:

The calibration of the XRF instrument should be checked using the paint film nearest 1.0 mg/cm² in the NIST Standard Reference Material (SRM) used (e.g., for NIST SRM 2579, use the 1.02 mg/cm² film).

If readings are outside the acceptable calibration check range, follow the manufacturer's instructions to bring the instruments into control before XRF testing proceeds.

SUBSTRATE CORRECTION VALUE COMPUTATION

Chapter 7 of the HUD Guidelines provides guidance on correcting XRF results for substrate bias. Supplemental guidance for using the paint film nearest 1.0 mg/cm² for substrate correction is provided:

XRF results are corrected for substrate bias by subtracting from each XRF result a correction value determined separately in each house for single-family housing or in each development for multifamily housing, for each substrate. The correction value is an average of XRF readings taken over the NIST SRM paint film nearest to 1.0 mg/cm² at test locations that have been scraped bare of their paint covering. Compute the correction values as follows:

- Using the same XRF instrument, take three readings on a bare substrate area covered with the NIST SRM paint film nearest 1 mg/cm². Repeat this procedure by taking three more readings on a second bare substrate area of the same substrate covered with the NIST SRM.
- Compute the correction value for each substrate type where XRF readings indicate substrate correction is needed by computing the average of all six readings as shown below.

For each substrate type (the 1.02 mg/cm² NIST SRM is shown in this example; use the actual lead loading of the NIST SRM used for substrate correction):

$$\left. \begin{array}{l} \text{Correction} \\ \text{Value} \end{array} \right\} = \frac{1^{st} + 2^{nd} + 3^{rd} + 4^{th} + 5^{th} + 6^{th} \text{ Reading}}{6} - 1.02 \text{ mg/cm}^2$$

- Repeat this procedure for each substrate requiring substrate correction in the house or housing development.

EVALUATING THE QUALITY OF XRF TESTING

Randomly select ten testing combinations for retesting from each house or from two randomly selected units in multifamily housing. Use either 15-second readings or 60-second readings.

Conduct XRF retesting at the ten testing combinations selected for retesting.

Determine if the XRF testing in the units or house passed or failed the test by applying the steps below.

Compute the Retest Tolerance Limit by the following steps:

Determine XRF results for the original and retest XRF readings. Do not correct the original or retest results for substrate bias. In single-family and multi-family housing, a result is defined as a single reading. Therefore, there will be ten original and ten retest XRF results for each house or for the two selected units.

Calculate the average of the original XRF result and retest XRF result for each testing combination.

Square the average for each testing combination.

Add the ten squared averages together. Call this quantity C.

Multiply the number C by 0.0072. Call this quantity D.

Add the number 0.032 to D. Call this quantity E.

Take the square root of E. Call this quantity F.

Multiply F by 1.645. The result is the Retest Tolerance Limit.

Compute the average of all ten original XRF results.

Compute the average of all ten retest XRF results.

Find the absolute difference of the two averages.

If the difference is less than the Retest Tolerance Limit, the inspection has passed the retest. If the difference of the overall averages equals or exceeds the Retest Tolerance Limit, this procedure should be repeated with ten new testing combinations. If the difference of the overall averages is equal to or greater than the Retest Tolerance Limit a second time, then the inspection should be considered deficient.

Use of this procedure is estimated to produce a spurious result approximately 1% of the time. That is, results of this procedure will call for further examination when no examination is warranted in approximately 1 out of 100 dwelling units tested.

BIAS AND PRECISION

Do not use these bias and precision data to correct for substrate bias. These bias and precision data were computed without substrate correction from samples with reported laboratory results less than 4.0 mg/cm² lead. There were 143 testing locations with a laboratory reported result equal to or greater than 4.0 mg/cm² lead. Of these, 1 had XRF readings less than 1.0 mg/cm². These data are for illustrative purposes only. Actual bias must be determined on the site. Inconclusive ranges provided above already account for bias and precision. Bias and precision ranges are provided whenever significant variability was found between machines of the same model.

MEASURED AT	SUBSTRATE	BIAS (mg/cm ²)	BIAS RANGES (mg/cm ²)	PRECISION (mg/cm ²)	PRECISION RANGES (mg/cm ²)
0.0 mg/cm ²	Brick	0.9	-	0.6	-
	Concrete	1.3	(0.6, 1.9)	0.6	(0.2, 0.6)
	Drywall	-0.1	(-0.3, 0.2)	0.3	(0.2, 0.3)
	Metal	0.9	(0.5, 1.4)	0.5	(0.4, 0.5)
	Plaster	0.8	(0.4, 1.7)	0.5	(0.4, 0.5)
	Wood	0.2	(-0.1, 1.0)	0.4	(0.3, 0.5)
0.5 mg/cm ²	Brick	0.9	-	0.6	-
	Concrete	1.3	(0.7, 1.9)	0.6	(0.5, 0.7)
	Drywall	0.0	(-0.2, 0.2)	0.4	(0.3, 0.4)
	Metal	1.1	(0.7, 1.6)	0.8	(0.4, 0.9)
	Plaster	0.8	(0.2, 1.6)	0.6	(0.4, 0.6)
	Wood	0.4	(0.1, 1.1)	0.6	(0.3, 0.9)
1.0 mg/cm ²	Brick	0.9	-	0.6	-
	Concrete	1.3	(0.7, 2.0)	0.7	(0.6, 0.8)
	Drywall	0.0	(-0.1, 0.2)	0.4	(0.4, 0.5)
	Metal	1.3	(0.9, 1.7)	1.0	(0.5, 1.1)
	Plaster	0.8	(0.0, 1.6)	0.6	(0.4, 0.7)
	Wood	0.6	(0.3, 1.3)	0.7	(0.3, 1.2)
2.0 mg/cm ²	Brick	0.9	-	0.6	-
	Concrete	1.3	(0.7, 2.0)	0.8	(0.6, 0.9)
	Drywall	0.1	(0.1, 0.2)	0.6	(0.5, 0.6)
	Metal	1.7	(1.4, 2.1)	1.4	(0.6, 1.6)
	Plaster	0.7	(-0.3, 1.6)	0.7	(0.4, 0.8)
	Wood	1.0	(0.8, 1.5)	0.9	(0.3, 1.7)

† Precision at 1 standard deviation

CLASSIFICATION OF RESULTS

XRF results are classified as positive if they are greater than the upper boundary of the inconclusive range, and negative if they are less than the lower boundary of the inconclusive range, or inconclusive if in between. The inconclusive range includes both its upper and lower bounds. Earlier editions of this *XRF Performance Characteristics Sheet* did not include both bounds of the inconclusive range as "inconclusive." While this edition of the Performance Characteristics Sheet uses a different system, the specific XRF readings that are considered positive, negative, or inconclusive for a given XRF model and substrate remain unchanged, so previous inspection results are not affected.

DOCUMENTATION

A document titled *Methodology for XRF Performance Characteristic Sheets* provides an explanation of the statistical methodology used to construct the data in the sheets, and provides empirical results from using the recommended inconclusive ranges or thresholds for specific XRF instruments. For a copy of this document call the National Lead Information Center Clearinghouse at 1-800-424-LEAD.

This XRF Performance Characteristics Sheet is a joint product of the U.S. Environmental Protection Agency (EPA) and the U.S. Department of Housing and Urban Development (HUD). The issuance of this sheet does not constitute rulemaking. The information provided here is intended solely as guidance to be used in conjunction with Chapter 7, Lead-Based Paint Inspection, of the *Guidelines for the Evaluation and Control of Lead-Based Paint Hazards in Housing*. EPA and HUD reserve the right to revise this guidance. Please address questions and comments on this sheet to: Director, Office of Lead Hazard Control (L), U.S. Department of Housing and Urban Development, 451 Seventh St, S.W., Washington, DC 20410.

Performance Characteristic Sheet

EFFECTIVE DATE: December 1, 2006

EDITION NO.: 5

MANUFACTURER AND MODEL:

Make: *Radiation Monitoring Devices*Model: *LPA-1*Source: *⁵⁷Co*

Note: This sheet supersedes all previous sheets for the XRF instrument of the make, model, and source shown above ***for instruments sold or serviced after June 26, 1995. For other instruments, see prior editions.***

FIELD OPERATION GUIDANCE

OPERATING PARAMETERS:

Quick mode or 30-second equivalent standard (Time Corrected) mode readings.

XRF CALIBRATION CHECK LIMITS:

0.7 to 1.3 mg/cm ² (inclusive)

SUBSTRATE CORRECTION:

For XRF results below 4.0 mg/cm², substrate correction is recommended for:

Metal using 30-second equivalent standard (Time Corrected) mode readings.

None using quick mode readings.

Substrate correction is not needed for:

Brick, Concrete, Drywall, Plaster, and Wood using 30-second equivalent standard (Time Corrected) mode readings

Brick, Concrete, Drywall, Metal, Plaster, and Wood using quick mode readings

THRESHOLDS:

30-SECOND EQUIVALENT STANDARD MODE READING DESCRIPTION	SUBSTRATE	THRESHOLD (mg/cm ²)
Results corrected for substrate bias on metal substrate only	Brick	1.0
	Concrete	1.0
	Drywall	1.0
	Metal	0.9
	Plaster	1.0
	Wood	1.0

QUICK MODE READING DESCRIPTION	SUBSTRATE	THRESHOLD (mg/cm ²)
Readings not corrected for substrate bias on any substrate	Brick	1.0
	Concrete	1.0
	Drywall	1.0
	Metal	1.0
	Plaster	1.0
	Wood	1.0

BACKGROUND INFORMATION

EVALUATION DATA SOURCE AND DATE:

This sheet is supplemental information to be used in conjunction with Chapter 7 of the HUD *Guidelines for the Evaluation and Control of Lead-Based Paint Hazards in Housing* ("HUD Guidelines"). Performance parameters shown on this sheet are calculated from the EPA/HUD evaluation using archived building components. Testing was conducted on approximately 150 test locations in July 1995. The instrument that performed testing in September had a new source installed in June 1995 with 12 mCi initial strength.

OPERATING PARAMETERS:

Performance parameters shown in this sheet are applicable only when properly operating the instrument using the manufacturer's instructions and procedures described in Chapter 7 of the HUD Guidelines.

XRF CALIBRATION CHECK:

The calibration of the XRF instrument should be checked using the paint film nearest 1.0 mg/cm² in the NIST Standard Reference Material (SRM) used (e.g., for NIST SRM 2579, use the 1.02 mg/cm² film).

If readings are outside the acceptable calibration check range, follow the manufacturer's instructions to bring the instruments into control before XRF testing proceeds.

SUBSTRATE CORRECTION VALUE COMPUTATION :

Chapter 7 of the HUD Guidelines provides guidance on correcting XRF results for substrate bias. Supplemental guidance for using the paint film nearest 1.0 mg/cm² for substrate correction is provided:

XRF results are corrected for substrate bias by subtracting from each XRF result a correction value determined separately in each house for single-family housing or in each development for multifamily housing, for each substrate. The correction value is an average of XRF readings taken over the NIST SRM paint film nearest to 1.0 mg/cm² at test locations that have been scraped bare of their paint covering. Compute the correction values as follows:

Using the same XRF instrument, take three readings on a bare substrate area covered with the NIST SRM paint film nearest 1 mg/cm². Repeat this procedure by taking three more readings on a second bare substrate area of the same substrate covered with the NIST SRM.

Compute the correction value for each substrate type where XRF readings indicate substrate correction is needed by computing the average of all six readings as shown below.

For each substrate type (the 1.02 mg/cm² NIST SRM is shown in this example; use the actual lead loading of the NIST SRM used for substrate correction):

$$\text{Correction value} = (1^{\text{st}} + 2^{\text{nd}} + 3^{\text{rd}} + 4^{\text{th}} + 5^{\text{th}} + 6^{\text{th}} \text{ Reading}) / 6 - 1.02 \text{ mg/cm}^2$$

Repeat this procedure for each substrate requiring substrate correction in the house or housing development.

EVALUATING THE QUALITY OF XRF TESTING:

Randomly select ten testing combinations for retesting from each house or from two randomly selected units in multifamily housing. Use either the Quick Mode or 30-second equivalent standard (Time Corrected) Mode readings.

Conduct XRF re-testing at the ten testing combinations selected for retesting.

Determine if the XRF testing in the units or house passed or failed the test by applying the steps below.

Compute the Retest Tolerance Limit by the following steps:

Determine XRF results for the original and retest XRF readings. Do not correct the original or retest results for substrate bias. In single-family and multi-family housing, a result is defined as a single reading. Therefore, there will be ten original and ten retest XRF results for each house or for the two selected units.

Calculate the average of the original XRF result and retest XRF result for each testing combination.

Square the average for each testing combination.

Add the ten squared averages together. Call this quantity C.

Multiply the number C by 0.0072. Call this quantity D.

Add the number 0.032 to D. Call this quantity E.

Take the square root of E. Call this quantity F.

Multiply F by 1.645. The result is the Retest Tolerance Limit.

Compute the average of all ten original XRF results.

Compute the average of all ten re-test XRF results.

Find the absolute difference of the two averages.

If the difference is less than the Retest Tolerance Limit, the inspection has passed the retest. If the difference of the overall averages equals or exceeds the Retest Tolerance Limit, this procedure should be repeated with ten new testing combinations. If the difference of the overall averages is equal to or greater than the Retest Tolerance Limit a second time, then the inspection should be considered deficient.

Use of this procedure is estimated to produce a spurious result approximately 1% of the time. That is, results of this procedure will call for further examination when no examination is warranted in approximately 1 out of 100 dwelling units tested.

BIAS AND PRECISION:

Do not use these bias and precision data to correct for substrate bias. These bias and precision data were computed without substrate correction from samples with reported laboratory results less than 4.0 mg/cm² lead. The data which were used to determine the bias and precision estimates given in the table below have the following properties. During the July 1995 testing, there were 15 test locations with a laboratory-reported result equal to or greater than 4.0 mg/cm² lead. Of these, one 30-second standard mode reading was less than 1.0 mg/cm² and none of the quick mode readings were less than 1.0 mg/cm². The instrument that tested in July is representative of instruments sold or serviced after June 26, 1995. These data are for illustrative purposes only. Actual bias must be determined on the site. Results provided above already account for bias and precision. Bias and precision ranges are provided to show the variability found between machines of the same model.

30-SECOND STANDARD MODE READING MEASURED AT	SUBSTRATE	BIAS (mg/cm ²)	PRECISION* (mg/cm ²)
0.0 mg/cm ²	Brick	0.0	0.1
	Concrete	0.0	0.1
	Drywall	0.1	0.1
	Metal	0.3	0.1
	Plaster	0.1	0.1
	Wood	0.0	0.1
0.5 mg/cm ²	Brick	0.0	0.2
	Concrete	0.0	0.2
	Drywall	0.0	0.2
	Metal	0.2	0.2
	Plaster	0.0	0.2
	Wood	0.0	0.2
1.0 mg/cm ²	Brick	0.0	0.3
	Concrete	0.0	0.3
	Drywall	0.0	0.3
	Metal	0.2	0.3
	Plaster	0.0	0.3
	Wood	0.0	0.3
2.0 mg/cm ²	Brick	-0.1	0.4
	Concrete	-0.1	0.4
	Drywall	-0.1	0.4
	Metal	0.1	0.4
	Plaster	-0.1	0.4
	Wood	-0.1	0.4

*Precision at 1 standard deviation.

CLASSIFICATION RESULTS:

XRF results are classified as positive if they are greater than the upper boundary of the inconclusive range, and negative if they are less than the lower boundary of the inconclusive range, or inconclusive if in between. The inconclusive range includes both its upper and lower bounds. Earlier editions of this *XRF Performance Characteristic Sheet* did not include both bounds of the inconclusive range as "inconclusive." While this edition of the Performance Characteristics Sheet uses a different system, the specific XRF readings that are considered positive, negative, or inconclusive for a given XRF model and substrate remain unchanged, so previous inspection results are not affected.

DOCUMENTATION:

An EPA document titled *Methodology for XRF Performance Characteristic Sheets* provides an explanation of the statistical methodology used to construct the data in the sheets, and provides empirical results from using the recommended inconclusive ranges or thresholds for specific XRF instruments. For a copy of this document call the National Lead Information Center Clearinghouse at 1-800-424-LEAD. A HUD document titled *A Nonparametric Method for Estimating the 5th and 95th Percentile Curves of Variable-Time XRF Readings Based on Monotone Regression* provides supplemental information on the methodology for variable-time XRF instruments. A copy of this document can be obtained from the HUD lead web site, www.hud.gov/offices/lead.

This XRF Performance Characteristic Sheet was developed by QuanTech, Inc., under a contract from the U.S. Department of Housing and Urban Development (HUD). HUD has determined that the information provided here is acceptable when used as guidance in conjunction with Chapter 7, Lead-Based Paint Inspection, of HUD's *Guidelines for the Evaluation and Control of Lead-Based Paint Hazards in Housing*.

Performance Characteristic Sheet

EFFECTIVE DATE: August 24, 1995

EDITION NO.: 3

MANUFACTURER AND MODEL :

Make: *Scitec Corporation*
 Model: *MAP-3*
 Source: *⁵⁷Co*
 Note: This sheet supersedes all previous sheets for the XRF instrument of the make, model, and source shown above.

FIELD OPERATION GUIDANCE

OPERATING PARAMETERS

Nominal Time Reading is 15 seconds or 60 seconds.

XRF CALIBRATION CHECK LIMITS

15-SECOND READINGS	60-SECOND READINGS
0.4 to 1.3 mg/cm ² (inclusive)	0.6 mg/cm ² to 1.1 mg/cm ² (inclusive)

SUBSTRATE CORRECTION:

For XRF results below 4.0 mg/cm², substrate is correction recommended for:

Metal and Wood

Substrate correction is not recommended for:

Brick, Concrete, Drywall, and Plaster

INCONCLUSIVE RANGE OR THRESHOLD

15-SECOND READING DESCRIPTION	SUBSTRATE	INCONCLUSIVE RANGE (mg/cm ²)
Results corrected for substrate bias for 15-second readings on metal and wood substrates only	Brick	0.01 to 1.49
	Concrete	0.01 to 1.49
	Drywall	0.91 to 0.99
	Metal	0.91 to 1.29
	Plaster	0.31 to 1.29
	Wood	0.91 to 1.29

60-SECOND READING DESCRIPTION	SUBSTRATE	THRESHOLD (mg/cm ²)	INCONCLUSIVE RANGE (mg/cm ²)
Readings corrected for substrate bias for 60-second readings on metal and wood substrates only	Brick	None	0.31 to 0.89
	Concrete	None	0.31 to 0.89
	Drywall	None	0.61 to 0.79
	Metal	None	0.91 to 1.19
	Plaster	None	0.21 to 0.91
	Wood	1.0	None

BACKGROUND INFORMATION

EVALUATION DATA SOURCE AND DATE

This sheet is supplemental information to be used in conjunction with Chapter 7 of the HUD *Guidelines for the Evaluation and Control of Lead-Based Paint Hazards in Housing* ("HUD Guidelines"). Performance parameters shown on this sheet are calculated from evaluation data collected during the EPA/HUD field evaluation study conducted from March through October 1993. The data were collected from four instruments at approximately 1,200 15-second test locations and 300 60-second test locations. One instrument had a January 1993 source and the other three instruments had July 1993 sources. All four instruments had sources with 40 mCi initial strengths. The results of this study are reported in *A Field Test of Lead-Based Paint Testing Technologies: Technical Report*, EPA 747-R-95-002b, May 1995.

OPERATING PARAMETERS

Performance parameters shown in this sheet are applicable only when properly operating the instrument using the manufacturer's instructions and procedures described in Chapter 7 of the HUD Guidelines.

XRF CALIBRATION CHECK:

The calibration of the XRF instrument should be checked using the paint film nearest 1.0 mg/cm² in the NIST Standard Reference Material (SRM) used (e.g., for NIST SRM 2579, use the 1.02 mg/cm² film).

If readings are outside the acceptable calibration check range, follow the manufacturer's instructions to bring the instruments into control before XRF testing proceeds

SUBSTRATE CORRECTION VALUE COMPUTATION

Chapter 7 of the HUD Guidelines provides guidance on correcting XRF results for substrate bias. Supplemental guidance for using the paint film nearest 1.0 mg/cm² for substrate correction is provided:

XRF results are corrected for substrate bias by subtracting from each XRF result a correction value determined separately in each house for single-family housing or in each development for multifamily housing, for each substrate. The correction value is an average of XRF readings taken over the NIST SRM paint film nearest to 1.0 mg/cm² at test locations that have been scraped bare of their paint covering. Compute the correction values as follows:

- Using the same XRF instrument, take three readings on a bare substrate area covered with the NIST SRM paint film nearest 1 mg/cm². Repeat this procedure by taking three more readings on a second bare substrate area of the same substrate covered with the NIST SRM.
- Compute the correction value for each substrate type where XRF readings indicate substrate correction is needed by computing the average of all six readings as shown below.

For each substrate type (the 1.02 mg/cm² NIST SRM is shown in this example; use the actual lead loading of the NIST SRM used for substrate correction):

$$\left. \begin{array}{l} \text{Correction} \\ \text{Value} \end{array} \right\} = \frac{1^{st} + 2^{nd} + 3^{rd} + 4^{th} + 5^{th} + 6^{th} \text{ Reading}}{6} - 1.02 \text{mg/cm}^2$$

- Repeat this procedure for each substrate requiring substrate correction in the house or housing development.

EVALUATING THE QUALITY OF XRF TESTING

Randomly select ten testing combinations for retesting from each house or from two randomly selected units in multifamily housing. Use either 15-second readings or 60-second readings.

Conduct XRF retesting at the ten testing combinations selected for retesting.

Determine if the XRF testing in the units or house passed or failed the test by applying the steps below.

Compute the Retest Tolerance Limit by the following steps:

Determine XRF results for the original and retest XRF readings. Do not correct the original or retest results for substrate bias. In single-family and multi-family housing, a result is defined as a single reading. Therefore, there will be ten original and ten retest XRF results for each house or for the two selected units.

Calculate the average of the original XRF result and retest XRF result for each testing combination.

Square the average for each testing combination.

Add the ten squared averages together. Call this quantity C.

Multiply the number C by 0.0072. Call this quantity D.

Add the number 0.032 to D. Call this quantity E.

Take the square root of E. Call this quantity F.

Multiply F by 1.645. The result is the Retest Tolerance Limit.

Compute the average of all ten original XRF results.

Compute the average of all ten retest XRF results.

Find the absolute difference of the two averages.

If the difference is less than the Retest Tolerance Limit, the inspection has passed the retest. If the difference of the overall averages equals or exceeds the Retest Tolerance Limit, this procedure should be repeated with ten new testing combinations. If the difference of the overall averages is equal to or greater than the Retest Tolerance Limit a second time, then the inspection should be considered deficient.

Use of this procedure is estimated to produce a spurious result approximately 1% of the time. That is, results of this procedure will call for further examination when no examination is warranted in approximately 1 out of 100 dwelling units tested.

BIAS AND PRECISION

Do not use these bias and precision data to correct for substrate bias. These bias and precision data were computed without substrate correction from samples with reported laboratory results less than 4.0 mg/cm² lead. There were 124 15-second testing locations with a laboratory reported result equal to or greater than 4.0 mg/cm² lead. Of these, none had XRF readings less than 1.0 mg/cm². For the 60-second testing locations, 34 had laboratory reported results equal to or greater than 4.0 mg/cm² lead, with 2 of those having XRF readings less than 1.0 mg/cm². These data are for illustrative purposes only. Actual bias must be determined on the site. Inconclusive ranges provided above already account for bias and precision.

15-SECOND READING MEASURED AT	SUBSTRATE	BIAS (mg/cm ²)	PRECISION* (mg/cm ²)
0.0 mg/cm ²	Brick	-0.7	0.9
	Concrete	-0.7	0.9
	Drywall	0.0	0.4
	Metal	0.3	0.3
	Plaster	-0.7	0.8
	Wood	-0.1	0.5
0.5 mg/cm ²	Brick	-0.5	1.0
	Concrete	-0.5	1.0
	Drywall	-0.1	0.4
	Metal	0.4	0.5
	Plaster	-0.6	0.8
	Wood	0.2	0.6
1.0 mg/cm ²	Brick	-0.4	1.0
	Concrete	-0.4	1.0
	Drywall	-0.1	0.4
	Metal	0.5	0.6
	Plaster	-0.4	0.9
	Wood	0.4	0.7
2.0 mg/cm ²	Brick	-0.1	1.2
	Concrete	-0.1	1.2
	Drywall	-0.3	0.4
	Metal	0.6	0.7
	Plaster	-0.2	0.9
	Wood	0.8	0.8
*Precision at 1 standard deviation			

60-SECOND READING MEASURED AT	SUBSTRATE	BIAS (mg/cm ²)	PRECISION* (mg/cm ²)
0.0 mg/cm ²	Brick	-0.8	0.7
	Concrete	-0.8	0.7
	Drywall	0.0	0.3
	Metal	0.3	0.2
	Plaster	-0.8	0.5
	Wood	-0.2	0.4
0.5 mg/cm ²	Brick	-0.7	0.7
	Concrete	-0.7	0.7
	Drywall	-0.2	0.3
	Metal	0.4	0.3
	Plaster	-0.6	0.7
	Wood	0.1	0.4
1.0 mg/cm ²	Brick	-0.7	0.7
	Concrete	-0.7	0.7
	Drywall	-0.4	0.3
	Metal	0.6	0.4
	Plaster	-0.5	0.8
	Wood	0.3	0.4
2.0 mg/cm ²	Brick	-0.6	0.7
	Concrete	-0.6	0.7
	Drywall	-0.8	0.3
	Metal	0.9	0.5
	Plaster	-0.1	1.0
	Wood	0.8	0.4
*Precision at 1 standard deviation			

CLASSIFICATION OF RESULTS

XRF results are classified as positive if they are greater than the upper boundary of the inconclusive range, and negative if they are less than the lower boundary of the inconclusive range, or inconclusive if in between. The inconclusive range includes both its upper and lower bounds. Earlier editions of this *XRF Performance Characteristics Sheet* did not include both bounds of the inconclusive range as "inconclusive." While this edition of the Performance Characteristics Sheet uses a different system, the specific XRF readings that are considered positive, negative, or inconclusive for a given XRF model and substrate remain unchanged, so previous inspection results are not affected.

DOCUMENTATION

A document titled *Methodology for XRF Performance Characteristic Sheets* provides an explanation of the

statistical methodology used to construct the data in the sheets, and provides empirical results from using the recommended inconclusive ranges or thresholds for specific XRF instruments. For a copy of this document call the National Lead Information Center Clearinghouse at 1-800-424-LEAD.

This XRF Performance Characteristics Sheet is a joint product of the U.S. Environmental Protection Agency (EPA) and the U.S. Department of Housing and Urban Development (HUD). The issuance of this sheet does not constitute rulemaking. The information provided here is intended solely as guidance to be used in conjunction with Chapter 7, Lead-Based Paint Inspection, of the *Guidelines for the Evaluation and Control of Lead-Based Paint Hazards in Housing*. EPA and HUD reserve the right to revise this guidance. Please address questions and comments on this sheet to: Director, Office of Lead Hazard Control (L), U.S. Department of Housing and Urban Development, 451 Seventh St, S.W., Washington, DC 20410.

Performance Characteristic Sheet

EFFECTIVE DATE: June 26, 1996

EDITION NO.: 3

MANUFACTURER AND MODEL :

Make: *Scitec Corporation*
Model: *MAP-4*
Source: *⁵⁷Co*
Note: This sheet supersedes all previous sheets for the XRF instrument of the make, model, and source shown above.

FIELD OPERATION GUIDANCE

OPERATING PARAMETERS

Test mode, Screen mode, or Unlimited mode.

XRF CALIBRATION CHECK LIMITS

0.6 to 1.2 mg/cm ² (inclusive)

SUBSTRATE CORRECTION:

When using Unlimited mode, substrate correction recommended for:

None

When using Unlimited mode, substrate correction not recommended for:

Brick, Concrete, Drywall, Metal, Plaster, and Wood

When using Screen or Test mode, for XRF results below 4.0 mg/cm², substrate correction recommended for:

Drywall, Metal, and Wood

When using Screen or Test mode, substrate correction not recommended for:

Brick, Concrete, and Plaster

INCONCLUSIVE RANGE OR THRESHOLD

UNLIMITED MODE READING DESCRIPTION	SUBSTRATE	INCONCLUSIVE RANGE (mg/cm ²)
Results not corrected for substrate bias for unlimited mode readings	Brick	0.91 to 1.19
	Concrete	0.91 to 1.19
	Drywall	0.91 to 1.19
	Metal	0.91 to 1.19
	Plaster	0.91 to 1.19
	Wood	0.91 to 1.19

SCREEN MODE READING DESCRIPTION	SUBSTRATE	INCONCLUSIVE RANGE (mg/cm ²)
Results corrected for substrate bias for screen mode readings on drywall, metal, and wood substrates only	Brick	0.91 to 1.09
	Concrete	0.91 to 1.09
	Drywall	0.91 to 1.39
	Metal	0.91 to 1.19
	Plaster	0.91 to 1.09
	Wood	0.91 to 1.29

TEST MODE READING DESCRIPTION	SUBSTRATE	THRESHOLD (mg/cm ²)	INCONCLUSIVE RANGE (mg/cm ²)
Readings corrected for substrate bias for test mode readings on drywall, metal, and wood substrates only	Brick	0.9	None
	Concrete	0.9	None
	Drywall	None	0.91 to 1.39
	Metal	None	0.91 to 1.09
	Plaster	0.9	None
	Wood	None	0.91 to 1.29

BACKGROUND INFORMATION

EVALUATION DATA SOURCE AND DATE

This sheet is supplemental information to be used in conjunction with Chapter 7 of the HUD *Guidelines for the Evaluation and Control of Lead-Based Paint Hazards in Housing* ("HUD Guidelines"). Performance parameters shown on this sheet are calculated from an EPA/HUD evaluation using archived building components. Testing was conducted on approximately 150 test locations. All of the test locations were tested in February 1996 using two different instruments. One instrument had a new source installed in July 1994 and its strength at the time of testing was calculated as 9.4 mCi. The other instrument had a new source installed in September 1994 and its strength at the time of testing was calculated as 10.6 mCi.

OPERATING PARAMETERS

Performance parameters shown in this sheet are applicable only when properly operating the instrument using the manufacturer's instructions and procedures described in Chapter 7 of the HUD Guidelines.

XRF CALIBRATION CHECK:

The calibration of the XRF instrument should be checked using the paint film nearest 1.0 mg/cm² in the NIST Standard Reference Material (SRM) used (e.g., for NIST SRM 2579, use the 1.02 mg/cm² film).

If readings are outside the acceptable calibration check range, follow the manufacturer's instructions to bring the instruments into control before XRF testing proceeds

SUBSTRATE CORRECTION VALUE COMPUTATION

Chapter 7 of the HUD Guidelines provides guidance on correcting XRF results for substrate bias. Supplemental guidance for using the paint film nearest 1.0 mg/cm² for substrate correction is provided:

XRF results are corrected for substrate bias by subtracting from each XRF result a correction value determined separately in each house for single-family housing or in each development for multifamily housing, for each substrate. The correction value is an average of XRF readings taken over the NIST SRM paint film nearest to 1.0 mg/cm² at test locations that have been scraped bare of their paint covering. Compute the correction values as follows:

- Using the same XRF instrument, take three readings on a bare substrate area covered with the

NIST SRM paint film nearest 1 mg/cm². Repeat this procedure by taking three more readings on a second bare substrate area of the same substrate covered with the NIST SRM.

- Compute the correction value for each substrate type where XRF readings indicate substrate correction is needed by computing the average of all six readings as shown below.

For each substrate type (the 1.02 mg/cm² NIST SRM is shown in this example; use the actual lead loading of the NIST SRM used for substrate correction):

$$\text{Correction Value} \left. \vphantom{\text{Correction Value}} \right\} = \frac{1^{st} + 2^{nd} + 3^{rd} + 4^{th} + 5^{th} + 6^{th} \text{ Reading}}{6} - 1.02 \text{ mg/cm}^2$$

- Repeat this procedure for each substrate requiring substrate correction in the house or housing development.

EVALUATING THE QUALITY OF XRF TESTING

Randomly select ten testing combinations for retesting from each house or from two randomly selected units in multifamily housing. Use either 15-second readings or 60-second readings.

Conduct XRF retesting at the ten testing combinations selected for retesting.

Determine if the XRF testing in the units or house passed or failed the test by applying the steps below.

Compute the Retest Tolerance Limit by the following steps:

Determine XRF results for the original and retest XRF readings. Do not correct the original or retest results for substrate bias. In single-family and multi-family housing, a result is defined as a single reading. Therefore, there will be ten original and ten retest XRF results for each house or for the two selected units.

Calculate the average of the original XRF result and retest XRF result for each testing combination.

Square the average for each testing combination.

Add the ten squared averages together. Call this quantity C.

Multiply the number C by 0.0072. Call this quantity D.

Add the number 0.032 to D. Call this quantity E.

Take the square root of E. Call this quantity F.

Multiply F by 1.645. The result is the Retest Tolerance Limit.

Compute the average of all ten original XRF results.

Compute the average of all ten retest XRF results.

Find the absolute difference of the two averages.

If the difference is less than the Retest Tolerance Limit, the inspection has passed the retest. If the difference of the overall averages equals or exceeds the Retest Tolerance Limit, this procedure should be repeated with ten new testing combinations. If the difference of the overall averages is equal to or greater than the Retest Tolerance Limit a second time, then the inspection should be considered deficient.

Use of this procedure is estimated to produce a spurious result approximately 1% of the time. That is, results of this procedure will call for further examination when no examination is warranted in approximately 1 out of 100 dwelling units tested.

TESTING TIMES:

For screen, test, and confirm modes, the MAP 4 instrument tests until a K-shell result is obtained relative to a level of precision. A result is "positive", "negative" or "retest" as displayed by indicator lights. For the unlimited mode, the MAP 4 instrument tests until a K-shell result is indicated relative to an action level (1.0 mg/cm² for archive testing) and the current precision, or until the the reading is terminated by releasing the trigger. A few unlimited mode readings were terminated because they exceeded the two-minute limit used for archive testing. The following tables provide testing time information for three testing modes. Insufficient information is available to provide this information for confirm mode. All times have been scaled to match an initial 12 mCi source. Note that source strength and factors such as substrate may affect testing times.

UNLIMITED MODE TESTING TIMES (Seconds)						
SUBSTRATE ^a	ALL DATA			MEDIAN FOR LABORATORY-MEASURED LEAD LEVELS (mg/cm ²)		
	25 th Percentile	Median	75 th Percentile	Pb < 0.25	0.25 ≤ Pb < 1.0	1.0 ≤ Pb
Wood Drywall	3	4	6	4	13	3
Metal	3	4	8	4	9	3
Brick Concrete Plaster	4	5	8	6	6	3

^aThe general calibration was used for wood, drywall, brick, concrete, plaster. Steel calibration was used for metal. (There are no aluminum samples in the archive facility).

SCREEN MODE TESTING TIMES (Seconds)						
SUBSTRATE ^a	ALL DATA			MEDIAN FOR LABORATORY-MEASURED LEAD LEVELS (mg/cm ²)		
	25 th Percentile	Median	75 th Percentile	Pb < 0.25	0.25 ≤ Pb < 1.0	1.0 ≤ Pb
Wood Drywall	4	6	7	5	6	7
Metal	4	5	6	5	5	5
Brick Concrete Plaster	11	11	13	11	11	11

^aThe general calibration was used for wood, drywall, brick, concrete, plaster. Steel calibration was used for metal. (There are no aluminum samples in the archive facility).

TEST MODE TESTING TIMES (Seconds)						
SUBSTRATE	ALL DATA			MEDIAN FOR LABORATORY-MEASURED LEAD LEVELS (mg/cm ²)		
	25 th Percentile	Median	75 th Percentile	Pb < 0.25	0.25 ≤ Pb < 1.0	1.0 ≤ Pb
Wood Drywall	17	22	27	21	20	28
Metal	13	20	23	20	20	20
Brick Concrete Plaster	41	42	52	41	46	43

^aThe general calibration was used for wood, drywall, brick, concrete, plaster. Steel calibration was used for metal. (There are no aluminum samples in the archive facility).

BIAS AND PRECISION

Do not use these bias and precision data to correct for substrate bias. These bias and precision data were computed without substrate correction from samples with laboratory-measured lead levels less than 4.0 mg/cm² lead. There were 15 testing locations taken in the screen mode with a laboratory-measured lead levels equal to or greater than 4.0 mg/cm² lead. None of these had XRF readings less than 1.0 mg/cm². There were 15 testing locations taken in the test mode with a laboratory-measured lead levels equal to or greater than 4.0 mg/cm² lead. None of these had XRF readings less than 1.0 mg/cm². There were not any testing locations taken in the confirm mode with a laboratory-measured lead levels equal to or greater than 4.0 mg/cm² lead. There were 15 testing locations taken in the unlimited mode with a laboratory-measured lead levels equal to or greater than 4.0 mg/cm² lead. None of these had XRF readings less than 1.0 mg/cm². All testing was done in February 1996 with two different instruments. The following data are for illustrative purposes only. Actual bias must be determined on the site. Inconclusive ranges provided above already account for bias and precision.

SCREEN MODE READING MEASURED AT	SUBSTRATE	BIAS (mg/cm ²)	PRECISION (mg/cm ²)
0.0 mg/cm ²	Brick	-0.1	0.3
	Concrete	-0.1	0.3
	Drywall	0.1	0.2
	Metal	0.1	0.3
	Plaster	-0.1	0.3
	Wood	0.0	0.2
0.5 mg/cm ²	Brick	0.0	0.3
	Concrete	0.0	0.3
	Drywall	0.3	0.4
	Metal	0.2	0.3
	Plaster	0.0	0.3
	Wood	0.2	0.4
1.0 mg/cm ²	Brick	0.1	0.4
	Concrete	0.1	0.4
	Drywall	0.5	0.6
	Metal	0.3	0.3
	Plaster	0.1	0.4
	Wood	0.4	0.6

2.0 mg/cm ²	Brick	0.4	0.5
	Concrete	0.4	0.5
	Drywall	0.9	0.8
	Metal	0.5	0.3
	Plaster	0.4	0.5
	Wood	0.7	0.8
*Precision at 1 standard deviation			

TEST MODE READING MEASURED AT	SUBSTRATE	BIAS (mg/cm ²)	PRECISION [*] (mg/cm ²)
0.0 mg/cm ²	Brick	-0.1	0.2
	Concrete	-0.1	0.2
	Drywall	0.1	0.1
	Metal	0.1	0.2
	Plaster	-0.1	0.2
	Wood	0.0	0.1
0.5 mg/cm ²	Brick	-0.1	0.3
	Concrete	-0.1	0.3
	Drywall	0.3	0.4
	Metal	0.2	0.2
	Plaster	-0.1	0.3
	Wood	0.2	0.4
1.0 mg/cm ²	Brick	-0.1	0.3
	Concrete	-0.1	0.3
	Drywall	0.5	0.6
	Metal	0.3	0.2
	Plaster	-0.1	0.3
	Wood	0.4	0.6
2.0 mg/cm ²	Brick	0.0	0.4
	Concrete	0.0	0.4
	Drywall	1.0	0.8
	Metal	0.5	0.2
	Plaster	0.0	0.4
	Wood	0.8	0.8
*Precision at 1 standard deviation			

CLASSIFICATION OF RESULTS

XRF results are classified as positive if they are greater than the upper boundary of the inconclusive range, and negative if they are less than the lower boundary of the inconclusive range, or inconclusive if in between. The inconclusive range includes both its upper and lower bounds. Earlier editions of this *XRF Performance Characteristics Sheet* did not include both bounds of the inconclusive range as "inconclusive." While this edition of the Performance Characteristics Sheet uses a different system, the specific XRF readings that are considered positive, negative, or inconclusive for a given XRF model and substrate remain unchanged, so previous inspection results are not affected.

DOCUMENTATION

A document titled *Methodology for XRF Performance Characteristic Sheets* provides an explanation of the statistical methodology used to construct the data in the sheets, and provides empirical results from using the recommended inconclusive ranges or thresholds for specific XRF instruments. For a copy of this document call the National Lead Information Center Clearinghouse at 1-800-424-LEAD.

This XRF Performance Characteristics Sheet is a joint product of the U.S. Environmental Protection Agency (EPA) and the U.S. Department of Housing and Urban Development (HUD). The issuance of this sheet does not constitute rulemaking. The information provided here is intended solely as guidance to be used in conjunction with Chapter 7, Lead-Based Paint Inspection, of the *Guidelines for the Evaluation and Control of Lead-Based Paint Hazards in Housing*. EPA and HUD reserve the right to revise this guidance. Please address questions and comments on this sheet to: Director, Office of Lead Hazard Control (L), U.S. Department of Housing and Urban Development, 451 Seventh St, S.W., Washington, DC 20410.

Performance Characteristics Sheet

EFFECTIVE DATE: October 31, 1995

EDITION NO.: 3

MANUFACTURER AND MODEL :

Manufacturer: *TN Technologies, Inc. (TN Spectrace)*

Make: *Pb Analyzer*

Model: *9292*

Source: ^{109}Cd

Note: This sheet supersedes all previous sheets for the XRF instrument of the make, model, and source shown above.

FIELD OPERATION GUIDANCE

OPERATING PARAMETERS

Nominal Time Reading is 15 seconds.

XRF CALIBRATION CHECK LIMITS

0.7 to 1.4 (inclusive)

SUBSTRATE CORRECTION:

Not required for any substrate.

INCONCLUSIVE RANGE OR THRESHOLD

DESCRIPTION	SUBSTRATE	INCONCLUSIVE RANGE in mg/cm ²	
		LOWER BOUND	UPPER BOUND
Results not corrected for substrate bias	Brick	0.91	1.19
	Concrete	0.91	1.19
	Drywall	0.91	1.19
	Metal	0.91	1.19
	Plaster	0.91	1.09
	Wood	0.91	1.29

BACKGROUND INFORMATION

EVALUATION DATA SOURCE AND DATE

This sheet supplements Chapter 7 of the HUD *Guidelines for the Evaluation and Control of Lead-Based Paint Hazards in Housing* ("HUD Guidelines"). Performance parameters shown on this sheet are derived from measurements of real world archived paint samples collected during the EPA/HUD field evaluation study, and from data collected during testing in January 1995 and in September 1995. The field evaluation data were collected from approximately 1,200 test locations using two instruments both with radiation sources installed in April 1993. See *A Field Test of Lead-Based Paint Testing Technologies: Technical Report*,

EPA 747-R-95-002b, May 1995 for further information. The archival testing data were collected from approximately 150 test locations using two instruments. The instrument that was used in January had a radiation source installed in July 1994 and the instrument that was used in September 1995 had a radiation source installed in January 1995. All of the instruments mentioned had 30 mCi initial strengths.

OPERATING PARAMETERS

Performance parameters shown in this sheet are applicable only when properly operating the instrument using the manufacturer's instructions and procedures described in Chapter 7 of the HUD Guidelines.

XRF CALIBRATION CHECK

The calibration of the XRF instrument should be checked using the film nearest 1.0 mg/cm^2 in the NIST Standard Reference Material (SRM) used (e.g., for NIST SRM 2579, use the 1.02 mg/cm^2 film).

If readings are outside the acceptable calibration check range, follow the manufacturer's instructions to bring the instruments into control before XRF testing proceeds

EVALUATING THE QUALITY OF XRF TESTING

Randomly select ten testing combinations for retesting from each house or from two randomly selected units in multifamily housing.

Conduct XRF retesting at the ten testing combinations selected for retesting.

Determine if the XRF testing in the units or house passed or failed the test by applying the steps below.

Compute the Retest Tolerance Limit by the following steps:

Determine XRF results for the original and retest XRF readings. Do not correct the original or retest results for substrate bias. In single-family and multi-family housing, a result is defined as a single reading. Therefore, there will be ten original and ten retest XRF results for each house or for the two selected units.

Calculate the average of the original XRF result and retest XRF result for each testing combination.

Square the average for each testing combination.

Add the ten squared averages together. Call this quantity C.

Multiply the number C by 0.0072. Call this quantity D.

Add the number 0.032 to D. Call this quantity E.

Take the square root of E. Call this quantity F.

Multiply F by 1.645. The result is the Retest Tolerance Limit.

Compute the average of all ten original XRF results.

Compute the average of all ten retest XRF results.

Find the absolute difference of the two averages.

If the difference is less than the Retest Tolerance Limit, the inspection has passed the retest. If the difference of the overall averages equals or exceeds the Retest Tolerance Limit, this procedure should be repeated with ten new testing combinations. If the difference of the overall

averages is equal to or greater than the Retest Tolerance Limit a second time, then the inspection should be considered deficient.

Use of this procedure is estimated to produce a spurious result approximately 1% of the time. That is, results of this procedure will call for further examination when no examination is warranted in approximately 1 out of 100 dwelling units tested.

BIAS AND PRECISION

Do not use these bias and precision data to correct for substrate bias. These bias and precision data were computed without substrate correction from samples with reported laboratory results less than 4.0 mg/cm² lead. There were 88 test locations with a laboratory reported result equal to or greater than 4.0 mg/cm² lead. Of these, none had XRF readings less than 1.0 mg/cm². These data are for illustrative purposes only. Bias and precision ranges are provided to show the variability found between machines of the same model.

MEASURED AT	SUBSTRATE	BIAS (mg/cm ²)	BIAS RANGE ^p (mg/cm ²)	PRECISION ^r (mg/cm ²)	PRECISION RANGE ^p (mg/cm ²)
0.0 mg/cm ²	Brick	0.0	(0.0, 0.0)	0.1	(0.1, 0.1)
	Concrete	0.0	(0.0, 0.0)	0.1	(0.1, 0.1)
	Drywall	0.0	(0.0, 0.0)	0.1	(0.1, 0.1)
	Metal	0.0	(-0.1, 0.1)	0.1	(0.1, 0.1)
	Plaster	0.0	(-0.1, 0.0)	0.1	(0.1, 0.1)
	Wood	0.0	(0.0, 0.0)	0.1	(<0.1, 0.1)
0.5 mg/cm ²	Brick	0.1	(0.0, 0.2)	0.3	(0.3, 0.3)
	Concrete	0.1	(0.0, 0.2)	0.3	(0.2, 0.3)
	Drywall	0.1	(0.0, 0.2)	0.3	(0.1, 0.3)
	Metal	0.1	(0.0, 0.3)	0.3	(0.3, 0.3)
	Plaster	0.0	(-0.1, 0.2)	0.3	(0.1, 0.3)
	Wood	0.1	(0.1, 0.2)	0.3	(0.3, 0.3)
1.0 mg/cm ²	Brick	0.2	(0.0, 0.4)	0.4	(0.4, 0.5)
	Concrete	0.2	(0.0, 0.4)	0.4	(0.3, 0.5)
	Drywall	0.2	(0.1, 0.4)	0.4	(0.2, 0.5)
	Metal	0.2	(0.0, 0.5)	0.4	(0.4, 0.5)
	Plaster	0.1	(-0.1, 0.3)	0.4	(0.1, 0.5)
	Wood	0.3	(0.1, 0.4)	0.4	(0.4, 0.5)
2.0 mg/cm ²	Brick	0.4	(0.0, 0.7)	0.6	(0.5, 0.6)
	Concrete	0.3	(0.0, 0.7)	0.5	(0.4, 0.6)
	Drywall	0.5	(0.3, 0.7)	0.5	(0.3, 0.6)
	Metal	0.4	(0.0, 0.8)	0.6	(0.5, 0.6)
	Plaster	0.2	(-0.3, 0.7)	0.5	(0.1, 0.6)
	Wood	0.5	(0.3, 0.7)	0.6	(0.5, 0.6)

^pRanges are provided to show the variability between machines of the same model.
^rPrecision at 1 standard deviation.

CLASSIFICATION OF RESULTS

XRF results are classified as positive if they are greater than the upper boundary of the inconclusive range, and negative if they are less than the lower boundary of the inconclusive range, or inconclusive if in between. The inconclusive range includes both its upper and lower bounds. Earlier editions of this *XRF Performance Characteristics Sheet* did not include both bounds of the inconclusive range as "inconclusive." While this edition

of the Performance Characteristics Sheet uses a different system, the specific XRF readings that are considered positive, negative, or inconclusive for a given XRF model and substrate remain unchanged, so previous inspection results are not affected.

DOCUMENTATION:

A document titled *Methodology for XRF Performance Characteristic Sheets* provides an explanation of the statistical methodology used to construct the data in the sheets, and provides empirical results from using the recommended inconclusive ranges or thresholds for specific XRF instruments. For a copy of this document call the National Lead Information Center Clearinghouse at 1-800-424-LEAD.

This XRF Performance Characteristics Sheet is a joint product of the U.S. Environmental Protection Agency (EPA) and the U.S. Department of Housing and Urban Development (HUD). The issuance of this sheet does not constitute rulemaking. The information provided here is intended solely as guidance to be used in conjunction with Chapter 7, Lead-Based Paint Inspection, of the *Guidelines for the Evaluation and Control of Lead-Based Paint Hazards in Housing*. EPA and HUD reserve the right to revise this guidance. Please address questions and comments on this sheet to: Director, Office of Lead Hazard Control (L), U.S. Department of Housing and Urban Development, 451 Seventh St, S.W., Washington, DC 20410.

Performance Characteristic Sheet

EFFECTIVE DATE: September 25, 1995

EDITION NO.: 3

MANUFACTURER AND MODEL :

Make: *Warrington, Inc.*
Model: *Microlead I revision 4*
Source: ⁵⁷Co
Note: This sheet supersedes all previous sheets for the XRF instrument of the make, model, and source shown above.

FIELD OPERATION GUIDANCE

OPERATING PARAMETERS

Nominal Reading Time is 15 seconds.

XRF CALIBRATION CHECK LIMITS

0.4 to 1.6 mg/cm ² (inclusive)

SUBSTRATE CORRECTION:

For XRF results below 4.0 mg/cm², substrate is correction recommended for:

Brick, Concrete, Drywall, Metal, and Wood.

Substrate correction is not needed for:

Plaster.

INCONCLUSIVE RANGE OR THRESHOLD

DESCRIPTION	SUBSTRATE	INCONCLUSIVE RANGE in mg/cm ²
Results corrected for substrate bias on all substrates except plaster	Brick	0.9 to 1.2
	Concrete	0.6 to 1.3
	Drywall	1.0 to 1.0
	Metal	1.0 to 1.3
	Plaster	0.8 to 1.5
	Wood	1.0 to 1.5

BACKGROUND INFORMATION

EVALUATION DATA SOURCE AND DATE

This sheet is supplemental information to be used in conjunction with Chapter 7 of the HUD *Guidelines for the Evaluation and Control of Lead-Based Paint Hazards in Housing* ("HUD Guidelines"). Performance parameters

shown on this sheet are calculated from evaluation data collected during the EPA/HUD field evaluation study conducted from March through October 1993. The data were collected from approximately 1,200 test locations using five instruments with source dates ranging from March 1993 to October 1993. All five instruments had sources with 10 mCi initial strengths. The results of this study are reported in *A Field Test of Lead-Based Paint Testing Technologies: Technical Report*, EPA 747-R-95-002b, May 1995.

OPERATING PARAMETERS

Performance parameters shown in this sheet are applicable only when properly operating the instrument using the manufacturer's instructions and procedures described in Chapter 7 of the HUD Guidelines.

XRF CALIBRATION CHECK:

The calibration of the XRF instrument should be checked using the paint film nearest 1.0 mg/cm² in the NIST Standard Reference Material (SRM) used (e.g., for NIST SRM 2579, use the 1.02 mg/cm² film).

If readings are outside the acceptable calibration check range, follow the manufacturer's instructions to bring the instruments into control before XRF testing proceeds

SUBSTRATE CORRECTION VALUE COMPUTATION

Chapter 7 of the HUD Guidelines provides guidance on correcting XRF results for substrate bias. Supplemental guidance for using the paint film nearest 1.0 mg/cm² for substrate correction is provided:

XRF results are corrected for substrate bias by subtracting from each XRF result a correction value determined separately in each house for single-family housing or in each development for multifamily housing, for each substrate. The correction value is an average of XRF readings taken over the NIST SRM paint film nearest to 1.0 mg/cm² at test locations that have been scraped bare of their paint covering. Compute the correction values as follows:

- Using the same XRF instrument, take three readings on a bare substrate area covered with the NIST SRM paint film nearest 1 mg/cm². Repeat this procedure by taking three more readings on a second bare substrate area of the same substrate covered with the NIST SRM.
- Compute the correction value for each substrate type where XRF readings indicate substrate correction is needed by computing the average of all six readings as shown below.

For each substrate type (the 1.02 mg/cm² NIST SRM is shown in this example; use the actual lead loading of the NIST SRM used for substrate correction):

$$\left. \begin{array}{l} \text{Correction} \\ \text{Value} \end{array} \right\} = \frac{1^{st} + 2^{nd} + 3^{rd} + 4^{th} + 5^{th} + 6^{th} \text{ Reading}}{6} - 1.02 \text{mg/cm}^2$$

- Repeat this procedure for each substrate requiring substrate correction in the house or housing development.

EVALUATING THE QUALITY OF XRF TESTING

Randomly select ten testing combinations for retesting from each house or from two randomly selected units in multifamily housing. Use either 15-second readings or 60-second readings.

Conduct XRF retesting at the ten testing combinations selected for retesting.

Determine if the XRF testing in the units or house passed or failed the test by applying the steps below.

Compute the Retest Tolerance Limit by the following steps:

Determine XRF results for the original and retest XRF readings. Do not correct the original or retest results for substrate bias. In single-family and multi-family housing, a result is defined as a single reading. Therefore, there will be ten original and ten retest XRF results for each house or for the two selected units.

Calculate the average of the original XRF result and retest XRF result for each testing combination.

Square the average for each testing combination.

Add the ten squared averages together. Call this quantity C.

Multiply the number C by 0.0072. Call this quantity D.

Add the number 0.032 to D. Call this quantity E.

Take the square root of E. Call this quantity F.

Multiply F by 1.645. The result is the Retest Tolerance Limit.

Compute the average of all ten original XRF results.

Compute the average of all ten retest XRF results.

Find the absolute difference of the two averages.

If the difference is less than the Retest Tolerance Limit, the inspection has passed the retest. If the difference of the overall averages equals or exceeds the Retest Tolerance Limit, this procedure should be repeated with ten new testing combinations. If the difference of the overall averages is equal to or greater than the Retest Tolerance Limit a second time, then the inspection should be considered deficient.

Use of this procedure is estimated to produce a spurious result approximately 1% of the time. That is, results of this procedure will call for further examination when no examination is warranted in approximately 1 out of 100 dwelling units tested.

BIAS AND PRECISION

Do not use these bias and precision data to correct for substrate bias. These bias and precision data were computed without substrate correction from samples with reported laboratory results less than 4.0 mg/cm² lead. There were 143 test locations with a laboratory reported result equal to or greater than 4.0 mg/cm² lead. Of these, 1 had an XRF reading less than 1.0 mg/cm². These data are for illustrative purposes only. Actual bias must be determined on the site. Inconclusive ranges provided above already account for bias and precision. Bias and precision ranges are provided whenever significant variability was found between machines of the same model.

MEASURED AT	SUBSTRATE	BIAS (mg/cm ²)	BIAS RANGES (mg/cm ²)	PRECISION (mg/cm ²)	PRECISION RANGES (mg/cm ²)
0.0 mg/cm ²	Brick	0.1	-	0.6	-
	Concrete	0.3	(0.0, 0.9)	0.6	(0.5, 1.2)
	Drywall	0.0	(0.0, 0.7)	0.3	(0.3, 0.5)
	Metal	-0.3	(-0.4, 1.1)	0.5	(0.3, 0.8)
	Plaster	0.1	(-0.3, 0.2)	0.5	(0.3, 0.6)
	Wood	0.4	(0.0, 0.5)	0.6	(0.5, 0.8)
0.5 mg/cm ²	Brick	-	-	-	-
	Concrete	0.3	(0.1, 1.1)	0.6	(0.5, 1.3)
	Drywall	0.1	(0.1, 1.3)	0.3	(0.3, 0.5)
	Metal	-0.2	(-0.3, 1.2)	0.6	(0.5, 0.8)
	Plaster	0.1	(-0.3, 0.1)	0.6	(0.4, 0.8)
	Wood	0.7	(0.2, 0.7)	0.7	(0.6, 0.8)

1.0 mg/cm ²	Brick	-0.3	-	0.6	-
	Concrete	0.3	(0.2, 1.2)	0.7	(0.6, 1.4)
	Drywall	0.2	(0.2, 1.9)	0.3	(0.3, 0.5)
	Metal	-0.1	(-0.1, 1.4)	0.6	(0.5, 0.8)
	Plaster	0.1	(-0.3, 0.3)	0.7	(0.5, 1.0)
	Wood	1.0	(0.3, 1.0)	0.7	(0.6, 0.8)
2.0 mg/cm ²	Brick	-	-	-	-
	Concrete	0.2	(0.2, 1.5)	0.8	(0.7, 1.7)
	Drywall	0.4	(0.1, 3.1)	0.3	(0.3, 0.5)
	Metal	0.2	(0.1, 1.7)	0.7	(0.5, 0.8)
	Plaster	0.2	(-0.3, 0.7)	0.9	(0.6, 1.2)
	Wood	1.6	(0.6, 1.7)	0.8	(0.7, 0.8)
*Precision at 1 standard deviation					

CLASSIFICATION OF RESULTS

XRF results are classified as positive if they are greater than the upper boundary of the inconclusive range, and negative if they are less than the lower boundary of the inconclusive range, or inconclusive if in between. The inconclusive range includes both its upper and lower bounds. Earlier editions of this *XRF Performance Characteristics Sheet* did not include both bounds of the inconclusive range as "inconclusive." While this edition of the Performance Characteristics Sheet uses a different system, the specific XRF readings that are considered positive, negative, or inconclusive for a given XRF model and substrate remain unchanged, so previous inspection results are not affected.

DOCUMENTATION

A document titled *Methodology for XRF Performance Characteristic Sheets* provides an explanation of the statistical methodology used to construct the data in the sheets, and provides empirical results from using the recommended inconclusive ranges or thresholds for specific XRF instruments. For a copy of this document call the National Lead Information Center Clearinghouse at 1-800-424-LEAD.

This XRF Performance Characteristics Sheet is a joint product of the U.S. Environmental Protection Agency (EPA) and the U.S. Department of Housing and Urban Development (HUD). The issuance of this sheet does not constitute rulemaking. The information provided here is intended solely as guidance to be used in conjunction with Chapter 7, Lead-Based Paint Inspection, of the *Guidelines for the Evaluation and Control of Lead-Based Paint Hazards in Housing*. EPA and HUD reserve the right to revise this guidance. Please address questions and comments on this sheet to: Director, Office of Lead Hazard Control (L), U.S. Department of Housing and Urban Development, 451 Seventh St, S.W., Washington, DC 20410.

A Nonparametric Method for Estimating the 5th and 95th Percentile Curves of Variable-Time XRF Readings Based on Monotone Regression

Prepared for the
HUD Office of Healthy Homes and Lead Hazard Control
by
QuanTech, Inc.

October 24, 2000

For some newer XRF instruments, readings are typically taken in a “variable-time” mode where the reading time depends on the lead level in the paint. As detailed in Appendix B of Methodology for XRF Performance Characteristic Sheets (EPA 747-R-95-008, September 1997), it is not appropriate to apply the parametric XRF measurement model to such readings.

Since the underlying distribution is unknown and suspected to be nonnormal, a nonparametric method, based on monotone regression, was developed to obtain estimates of the 5th and 95th percentile XRF readings, as functions of the true lead level. This method applies the assumption that the percentiles are increasing functions of the lead level. Monotone regression is the solution to a quadratic programming problem, and is obtained with the “pool adjacent violators” (PAV) algorithm. The solution takes the form of a step function, formed by percentiles of the data over subgroups in a way that the percentiles do not decrease. Although a monotone regression cannot be “smooth” in appearance, it will approximate the true response if the sample is large, and if the true response is itself a nondecreasing function. A full treatment of monotone regression can be found in Statistical Inference Under Order Restrictions (Barlow, Bartholomew, Bremner, and Brunk, Wiley 1972). The nonparametric 5th and 95th percentile curves are applied to determine the threshold/inconclusive range for the PCS for an instrument with variable-time readings. Because the method is nonparametric, there is typically insufficient data to develop thresholds/inconclusive ranges separately by substrate.

Chapter 8: Resident Protection and Worksite Preparation

HOW TO DO IT	8-3
I. Introduction	8-4
II. General Requirements and Other Guidance	8-4
A. Small Areas of Paint Disturbance, and Basic Good Work Practices	8-4
B. Resident Entry into Work Area Prohibited	8-5
C. Pre-Renovation Education	8-6
D. Written Occupant Protection Plan for Abatement Projects	8-7
E. Site Assessment and Pre-Cleaning	8-8
F. Vacuums: HEPA vs. non-HEPA	8-8
G. Worker Protection	8-8
H. Lead-Safe Work Practices	8-9
I. Debris Control	8-10
III. Worksite Preparation	8-10
A. Introduction	8-10
B. Interior Worksite Preparation	8-11
C. Worksite Preparation for Exterior Paint-Disturbing Work	8-24
1. Resident Location	8-24
2. Containment and Barrier System	8-24
3. Playground Equipment, Toys, Sandbox, and Outdoor Furniture	8-25
4. Security	8-26
5. Warning Signs	8-26
6. Weather	8-26
7. Cleanup	8-26
D. Worksite Preparation for Windows	8-27
E. Worksite Preparation for Soil-Lead Hazard Controls	8-28
IV. Temporary Relocation	8-29
A. When Is Relocation Necessary and What Are the Options?	8-29
1. Work Is a Small Area	8-29
2. Work Is Only on the Outside	8-29
3. Work and Clearance Take Only One Day	8-29
4. Work Area Is Limited and Work Is of Short Duration	8-30
5. Exception for Elderly Residents	8-30
B. What Relocation Units Are Acceptable?	8-32
C. Allowing Reoccupancy after Interim Clearance	8-32
D. Who Should Pay?	8-33
E. How Can Costs Be Minimized?	8-33

F. Communicating with Residents 8-34

V. Negative Pressure Zones (“Negative Air” Machines) 8-35

REFERENCES 8-37

FIGURES

Figure 8.1 Prohibiting resident entry into work area by use of containment barrier. 8-5

Figure 8.2 EPA “Renovate Right” Pamphlet. 8-7

Figure 8.3 Structural deficiency. 8-8

Figure 8.4 Example of structural deficiency needing repair prior to work. 8-8

Figure 8.5 One example of a commercial-type HEPA vacuum. 8-9

Figure 8.6 Inadequate worker protection during a large overhead paint stripping project. 8-9

Figure 8.7 Placing coffee station in the work area is an unsafe work practice. 8-9

Figure 8.8 Floor plastic in work area. 8-15

Figure 8.9 Plastic barrier between living space and work area. 8-16

Figure 8.10 Interior warning sign. 8-17

Figure 8.11 Exterior warning sign for project shown in Figure 8.10 8-17

Figure 8.12 Items that are too large to move should be sealed completely and taped. 8-19

Figure 8.13 Removal and wrapping contaminated carpet. 8-20

Figure 8.14 Exterior containment of polyethylene sheeting lines the narrow walkway between two houses. 8-25

Figure 8.15 Exterior containment on building and window; ladder kept on plywood. 8-25

Figure 8.16 Example of barrier tape used as an occupant protection measure. 8-26

Figure 8.17 Pre-cleaning window with HEPA vacuum. 8-27

Figure 8.18 Sample Informed Consent Form for Residents of Housing for the Elderly. 8-31

TABLES

Table 8.1 Interior Worksite Preparation (Not Including Windows) 8-13

Chapter 8: Resident Protection and Worksite Preparation

How to Do It

1. **If possible, perform the work in a vacant unit.** If this is not possible, relocate residents if the work in their unit will last for more than a short time. If residents must remain inside the dwelling during work, appropriate containment and barrier systems as described in this chapter should be installed. Never permit residents to enter a work area where work disturbing known or presumed lead-based paint, or cleanup of lead-contaminated dust or soil, is underway. See Section IV, Temporary Relocation.
2. **Determine requirements** for relocation, isolation of work areas, and other worksite preparation measures based on the type and extent of the work and the amount of dust that will be generated. Use guidance in Section III of this chapter. Avoid high-dust jobs and procedures, if at all possible.
3. **Perform pre-renovation education about lead-based paint hazards** as required by EPA regulations and some State, tribal and/or local requirements. Consider providing pre-renovation education even if the regulations do not require doing so.
4. **Determine if the dwelling will require pre-cleaning** before worksite containment. (See Section II.E.) If the paint is severely deteriorated and paint chips or dust or debris are present, vacuum the floor before protective sheeting is laid down.
5. **Implement relocation plan, if needed, and begin worksite preparation.**
6. **Restrict access to the work area.** As noted above, never permit residents to enter the work area. When clearance or cleaning verification is performed, entry should be denied until cleaning is complete, and clearance or cleaning verification, as applicable, has been achieved. If clearance or cleaning verification has not been achieved at the end of the day, keep the barriers in place overnight and instruct residents not to enter the work area. Exceptions to these rules are available for elderly residents and hardship cases. See Section IV.A.5.
7. **Conduct daily cleanup.** See the Cleanup row of Table 8.1.
8. **Perform a visual examination daily.** Conduct this examination to ensure that dust, debris and residue outside the contained work area are removed, and that the contained area has been cleaned up adequately by the daily cleanup.
9. **Perform final cleanup after work is finished.** See the Cleanup row of Table 8.1.
10. **Do not allow residents to reoccupy the work area until a clearance examination, or cleaning verification, as applicable, has been passed.** See the item 10, Clearance, in the How to Do It list at the start of Chapter 11.
11. **Notification of residents.** The property owner or manager should notify residents of what lead-based paint hazards were controlled and how, and the results of the clearance examination or cleaning verification, as applicable – HUD recommends that the residents be notified whether or not the work is federally assisted (if the work is not federally assisted, only the person who ordered the work must be informed of its results).

I. Introduction

Many forms of paint-disturbing work, including renovation, maintenance, and rehabilitation, as well as lead hazard controls, generate varying amounts of leaded dust, paint chips, and other lead-contaminated materials. This chapter describes ways to protect residents and the environment from exposure to, or contamination from, these materials. Some types of work require complete isolation, or containment, of the work area and/or full evacuation of the residents and their belongings. Other jobs require much less site preparation and containment.

Containment refers to various methods of preventing leaded dust from migrating beyond the work area. It includes a variety of measures, including the simple use of disposable, impermeable protective sheeting as drop cloths, the sealing of doors and vents with such sheeting using tape, and measures taken by workers to keep from tracking leaded dust into non-work areas. The required degree of containment depends upon a number of considerations, including: the amount of dust that will be generated (which is affected by the nature of the work and the work practices that are used); resident re` possibilities; the size of the work area; the duration of the job; whether the work is interior or exterior or both; the construction skill levels of workers applicable to their performing specific tasks on the job; and whether there will be air movement within an interior work area due to open windows.

Generally speaking, only small-scale activity should be conducted in occupied units; significant lead hazard control work should be performed in units from which residents have been temporarily relocated or units that are otherwise vacant. Worksite preparation is needed for both interim controls and abatement work. It is also recommended, and sometimes required, for renovation and maintenance jobs if lead-based paint is or may be disturbed.

This chapter describes the general principles behind resident protection and proper worksite preparation. Guidance is provided for interior work, exterior work, window work, and soil-lead hazard control.

Activities that are required by HUD or EPA are identified in this chapter as being “required” or as actions that “must” be done. Activities that are not required by HUD but are recommended by these *Guidelines* are identified as being “recommended” or as actions that “should” be done. Activities that may be done at the discretion of the owner, manager, or contractor are identified as “optional.”

II. General Requirements and Other Guidance

A. Small Areas of Paint Disturbance, and Basic Good Work Practices

HUD and EPA regulations do not require the resident protection and worksite preparation practices described in this chapter for non-abatement work if the total amount of disturbed painted surfaces falls within what the HUD Lead Safe Housing Rule (LSHR) (see Appendix 6) refers to as a *de minimis amount*, i.e., a very small area that can be repaired without trained workers, lead-safe work practices or a clearance examination. This small area threshold, which applies to HUD-assisted and HUD-owned housing (and work on other housing that uses the LSHR threshold, inclusive of state and local laws) referred to here as the *de minimis*, is a disruption of no more than:

- ◆ 20 square feet (2 square meters) on exterior surfaces;
- ◆ 2 square feet (0.2 square meters) in any one interior room or space; or
- ◆ 10 percent of the total surface area on an interior or exterior type of component with a small surface area, such as window sills, baseboards, and trim.

EPA excludes from coverage under its Renovation, Repair, and Painting (RRP) Rule (see Appendix 6), a somewhat larger area of interior work than HUD does under its Lead Safe Housing Rule, but does not have an exclusion for work on small amounts of components with small surface areas. EPA's regulatory exclusion is for what the agency calls "minor repair and maintenance activities," which are those that disrupt no more than:

- ◆ 6 square feet or less of painted surface per room for interior activities; or
- ◆ 20 square feet or less of painted surface for exterior activities;

provided that:

- ◆ the work practices prohibited or restricted by the RRP Rule are **not** used; and
- ◆ the work does **not** involve window replacement or demolition of painted surface areas.

(Note that the EPA does not have a minimum size threshold for coverage of its lead abatement rule (see Appendix 6), and that some State, Tribal and local regulations may not recognize these thresholds and may cover work above a smaller threshold or work of any size, however small.)

However, dry scraping or dry sanding even a small amount of lead-based paint can create a lot of lead-contaminated dust, so these *Guidelines* recommend that the following minimal good work practices always be observed when disturbing paint in pre-1978 housing, unless it is known that all layers of paint to be disturbed are not lead-based paint: (the Lead Safe Housing Rule does allow for a limited exception from lead-safe work practices (LSWP; see Section II.D of Chapter 11) on post-1977 components):

- 1) Never use the prohibited methods of paint removal that are described in Section III.C.1 of Chapter 6 and Section II.D.1 of Chapter 11; and
- 2) When disturbing paint, always keep residents and pets out of the work area while work is underway and until after the cleanup, and clean the work area thoroughly after finishing, preferably with both high efficiency particulate air (HEPA) vacuuming and wet cleaning.



FIGURE 8.1 Prohibiting resident entry into work area by use of containment barrier.

B. Resident Entry into Work Area Prohibited

In projects covered by the HUD LSHR, and/or the EPA RRP Rule *residents must never be permitted to enter the work area while work is under way. Furthermore, resident reentry into the work area is permitted only after the area has been cleaned and, if required, has passed clearance* (under the LSHR or, optionally, under the RRP Rule) *or cleaning verification* (under the RRP Rule) (see Figure 8.1). While the two rules allow residents to remain in the work area when work that disturbs less the applicable small area threshold is being conducted, both agencies strongly discourage that practice.

All of the worksite preparation strategies discussed in this chapter are based on this fundamental approach. While residents may not be present inside the work area for work covered by the regulations, it is possible for the residents to remain inside other parts of the dwelling during some types of work, or to

leave for the day and return to the dwelling at night after cleaning, visual evaluation for dust, debris and residue outside of the contained area, and collection of dust samples.

C. Pre-Renovation Education

EPA's RRP regulations amended the Pre-Renovation Education requirements (PRE) by requiring that people who perform renovation of most pre-1978 housing for compensation provide a lead renovation pamphlet to owners and occupants before beginning the renovation (40 CFR 745.84). (See below for information on the pamphlet.) The information contained in the lead renovation pamphlet that is given to owners and occupants before beginning the renovation should be provided in appropriate format(s) to meet the needs of all residents including persons with limited English proficiency and in formats that may be needed for persons who are visually or hearing impaired (Executive Order 13166, derived from Title VI of the Civil Rights Act of 1964).

Renovation is defined in the regulation broadly as "the modification of any existing structure, or portion thereof, that results in the disturbance of painted surfaces, unless that activity is performed as part of an abatement as defined by this part" (40 CFR 745.223). Note that EPA requires resident protection whenever abatement of lead-based paint hazards is being conducted (40 CFR 745.227(e)(5)).

This pre-renovation education requirement does *not* apply to minor repair and maintenance activities, as described above, emergency renovations; renovations of components that have been found by a certified lead-based paint inspector or a certified renovator to be free of lead-based paint; or housing that is not target housing (housing built after 1977, housing that is exclusively for the elderly or persons with disabilities (provided a child of less than 6 does not reside there), and zero-bedroom units).

Emergency renovations are those activities that were not planned but result from a sudden, unexpected event (such as non-routine failures of equipment) that, if not immediately attended to, presents a safety or public health hazard, or threatens equipment and/or property with significant damage; and also interim controls performed in response to an elevated blood lead level in a resident child (see Chapter 16). The RRP rule requires that before work begins, the contractor must give the occupants the EPA pamphlet titled "Renovate Right: Important Lead Hazard Information for Families, Child Care Providers and Schools" in English, and "Guía de Prácticas Acreditadas Seguras para Trabajar con el Plomo para Remodelar Correctamente" ("Remodelar Correctamente") in Spanish, or any State or Tribal pamphlet approved by EPA for the same purpose.

Copies of "Renovate Right" can be obtained from the National Lead Information Center, at 1-800-424-LEAD, or by downloading it from the EPA's or HUD's web site. As of the publication of these *Guidelines*, the pamphlet is available in English and Spanish:

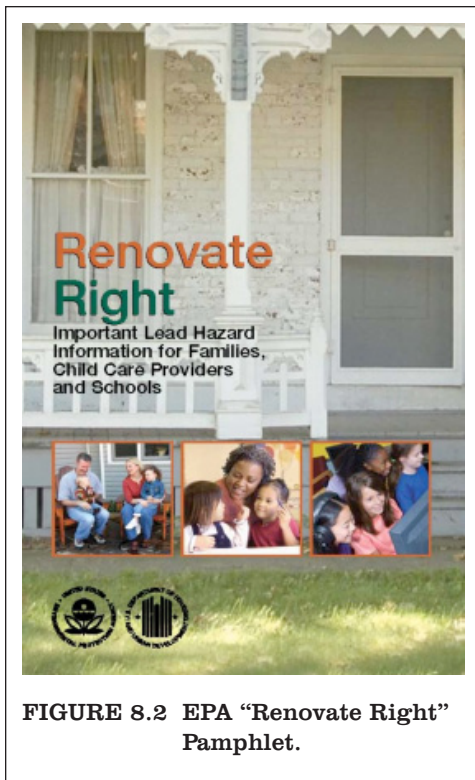


FIGURE 8.2 EPA “Renovate Right” Pamphlet.

- ◆ On the EPA website, the English version is available at <http://www.epa.gov/lead/pubs/renovaterightbrochure.pdf>, and the Spanish version, at <http://www.epa.gov/lead/pubs/renovaterightbrochure-esp.pdf>.
- ◆ On the HUD website, the English version is available at http://portal.hud.gov/hudportal/documents/huddoc?id=DOC_12531.pdf, and the Spanish version, at http://portal.hud.gov/hudportal/documents/huddoc?id=DOC_12532.pdf.

Renovation firms should determine if the State or Tribe is authorized to operate its lead program for abatement, at <http://www.epa.gov/oppt/lead/pubs/traincert.htm>, and/or for renovation, at <http://www.epa.gov/lead/pubs/renovation.htm>. Links are provided to individual authorized abatement and renovation programs if they are available. Addresses and links of the EPA Regional Lead Coordinators are provided for States and Tribal areas for which EPA operates the certification and accreditation programs, at EPA’s Where You Live lead page, at <http://www.epa.gov/lead/pubs/leadoff1.htm>. The sites also provide the forms and instructions provided to apply for accreditation or certification for EPA-operated programs. You can get additional assistance from the National Lead Information Center (NLIC) at 800-424-LEAD (5323); hearing- or speech-challenged individuals may access this number through TTY by calling the toll-free Federal Relay Service at 800-877-8339.

D. Written Occupant Protection Plan for Abatement Projects

EPA regulations require that a written occupant protection plan be developed for all abatement projects (40 CFR 745.227(e)(5)). The term “abatement,” as defined by EPA, “means any measure or set of measures designed to permanently eliminate lead-based paint hazards.” It “does not include renovation, remodeling, landscaping or other activities, when such activities are not designed to permanently eliminate lead-based paint hazards, ... even though these activities may incidentally result in a reduction or elimination of lead-based paint hazards.” (40 CFR 745.223). The occupant protection plan is required to:

- ◆ be unique to the dwelling or facility;
- ◆ be developed before the abatement;
- ◆ describe the measures and procedures that will be taken to protect the occupants from exposure to lead-based paint hazards; and
- ◆ be prepared by a certified lead-based paint abatement supervisor or certified project designer.

E. Site Assessment and Pre-Cleaning

If structural deficiencies exist, they have to be corrected before the site can be prepared for paint-disturbing work (see Figures 8.3 and 8.4). Worksite preparation, resident, environmental, and worker protection is required to be provided if the structural repairs will involve disturbance of surfaces coated with lead-based paint.

If the paint is deteriorated and there are paint chips or dust or debris present, vacuum the floor before protective sheeting is laid down (see the next subsection). Vacuuming will prevent the paint chips from being ground into dust by the workers' feet. Wet cleaning usually is not required for pre-cleaning.

F. Vacuums: HEPA vs. non-HEPA

Vacuum cleaners used for cleaning up dust as a lead hazard control measure must be high efficiency particulate air (HEPA) vacuums if the work is covered by OSHA's Lead in Construction rule, EPA's RRP Rule, or HUD's LSHR. (See Appendix 6, and, in particular, 29 CFR 1926.62(h)(4), 40 CFR 745.85(b)(2)(A) and (B), and 24 CFR 35.145 and 150(b), respectively.)

HEPA vacuums differ from conventional vacuums in that they contain high-efficiency filters that are capable of trapping extremely small, micron-sized particles. These filters can remove particles of 0.3 microns or greater from air at 99.97 percent efficiency or greater. (A micron is 1 millionth of a meter, or about 0.00004 of an inch.) See figure 8.5.

There is more to a vacuum than the filter. Other important factors that determine the effectiveness of a vacuum are velocity suction (which is a function of the motor, the design of the suction tool, and the extent to which the rest of the system does not release air before it is supposed to), quality of construction (which may determine the durability of the machine and whether there are air pressure leaks before the filtration), and whether the vacuum has special tools, such as a crevice tool. (See the further discussion of "Selecting a vacuum" in Chapter 11, section V.B.2.)

G. Worker Protection

Workers must be protected from exposure to lead by wearing protective clothing, practicing personal hygiene, and using lead-safe work practices (see Figure 8.6). Regardless of the size or dustiness of the job, OSHA requires that employers perform exposure monitoring of workers to determine the

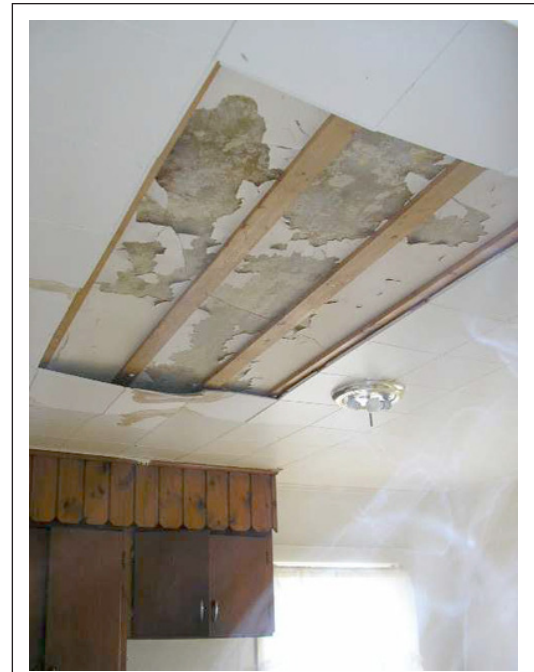


FIGURE 8.3 Structural deficiency.



FIGURE 8.4 Example of structural deficiency needing repair prior to work.



FIGURE 8.5 One example of a commercial-type HEPA vacuum.



FIGURE 8.6 Inadequate worker protection during a large overhead paint stripping project. Depending on exposure, this worker should be wearing protective clothing, long chemical-resistant gloves and a respirator; and should also be protected against falls.

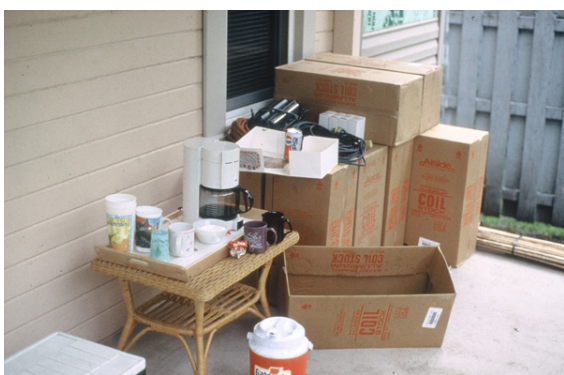


FIGURE 8.7 Placing coffee station in the work area is an unsafe work practice.

protective measures that are needed. Refer to 29 CFR 1926.62(g), Protective Work Clothing and Equipment, for specific requirements. These protective measures will help protect workers' families, because leaded dust will not be brought home, and will contribute to protecting the homes where they are working from lead contamination. Generally, protective clothing can include eye protection (always recommended), coveralls, head and hair protection (a painter's hat or a hard hat), disposable cotton gloves, latex/rubber gloves (when using detergents), disposable booties, and, if applicable, appropriate respiratory protection.

Personal hygiene includes the following "don'ts:"

- ◆ No smoking;
- ◆ No eating;
- ◆ No drinking (see Figure 8.7 for an unsafe work practice);
- ◆ No chewing; and
- ◆ No applying cosmetics in the work area.

Workers who perform these "don't" activities with lead on their hands put themselves at risk of ingesting lead. Workers should always wash their face and hands with soap and water before eating, drinking, or smoking and before leaving the site. Clothing should be changed before leaving the worksite. Tools should be cleaned.

Paint-removal practices described in Section II.D of Chapter 11 reduce the amount of dust created by the work and thus the likelihood of worker exposure. For complete information on worker protection, consult Chapter 9.

H. Lead-Safe Work Practices

Workers performing paint-disturbing work should use lead-safe work practices, in accordance with guidance at Section II.D of Chapter 11. Overall, this means that workers must never use prohibited paint-removal practices, should work wet to dampen dust spread (except where this would create an electrical safety hazard), and should clean up thoroughly after the work. During paint-disturbing work, painted surfaces should be wetted with a fine mist of water or water mixed with a surfactant before scraping or sanding to reduce generation of airborne paint dust, followed by wet HEPA vacuuming. Appropriate consideration should be given to potential electrical hazards that may be created by the presence of water. In addition, the occupant protection and worksite preparation measures described in this chapter are part of lead-safe work practices.

I. Debris Control

In general, see the discussion of debris control throughout Table 8.1, below.

In *occupied dwellings*, ensuring that cleaning of interior and exterior work areas is conducted as the work progresses and at the end of each work day or work shift is essential for conducting paint-disturbing work safely. Neither debris nor protective sheeting may be left outside the dwelling overnight or in any area where passersby, especially children, could come into contact with these materials. These practices prevent the spread of lead-contaminated dust. EPA's RRP rule requires dust to be contained at the end of each work day regardless of whether the dwelling is occupied.

These *Guidelines* additionally note that *continual cleaning* is especially important when residents are present in the dwelling while work is in progress, or when residents return in the evening after work has been completed for the day. (See Section IV, Temporary Relocation, below.) When residents cannot be relocated and work is staged to proceed room by room, clearance standards may be more difficult to meet because dust from moved furniture may cause recontamination. In this situation, it is recommended that furniture be cleaned before moving it to an area where work and cleaning have been completed.

All debris is required to be handled and disposed of in accordance with the standards outlined in Chapter 10.

III. Worksite Preparation

A. Introduction

This section provides guidance on worksite preparation for interior and exterior paint-disturbing work, and it provides separate guidance for work on windows and for soil-lead hazard control. All recommendations in this section include the use of lead-safe work practices, including, most importantly, compliance with prohibitions against certain paint-removal practices described in Section II.D of Chapter 11.

The general purpose of worksite preparation is to minimize, contain, and control dust and debris created by the work. There are five objectives for worksite preparation:

- ◆ Protect residents and workers from exposure to lead in dust, paint chips, and other debris created by the work.
- ◆ Protect residents' belongings from contamination with lead.
- ◆ Leave the surfaces of dwellings and common areas free of dust-lead hazards.
- ◆ Protect the exterior environment, both on and off the subject property, from contamination.
- ◆ Protect adjacent homes from contamination.

The measures recommended in this chapter help protect workers from exposing themselves to lead in dust, contaminating their cars and homes, and endangering their children.

Factors affecting the worksite preparation measures needed for a specific job include the following:

- ◆ The amount and spread of dust likely to be created by the job, which in turn is affected by the size of the surfaces needing work; the location of the work (e.g., ceiling vs. lower wall); and the nature of the work and the methods being used. For example, the enclosure of walls may require a lower worksite preparation level than the wet scraping of a large area because enclosure will disturb less paint and generate less dust. Similarly, demolition associated with replacement of deteriorated components will probably require a higher containment level than the wet scraping of a small area.
- ◆ The amount of air movement in the work area.
- ◆ The location of residents.
- ◆ The building layout.
- ◆ The proximity of the building to other properties.
- ◆ The extent to which there will be other construction or abatement work (e.g., renovation or asbestos abatement) that will be concurrent or sequential with the work being planned.
- ◆ Worker protection needs may also be a factor.

EPA's RRP rule requires that dust not leave the work area. These *Guidelines* are performance-oriented and are not specifications. It is possible to devise a unique worksite preparation approach for an individual dwelling if it achieves the five objectives stated above and if clearance, if required, is achieved. Containment measures should be designed to prevent the release of lead-containing dust, which can be spread by workers' shoes or by airborne dust.

Whatever combination of containment measures is selected, the levels of lead in dust outside the containment area must not rise above clearance levels. A previously conducted risk assessment, or selective dust testing conducted for this purpose, will indicate if hazardous dust-lead levels exist outside the containment area. If dust-lead levels rise in the course of the work, it is reasonable to conclude that the dust was released from the containment area and that the containment system is ineffective. Dust sampling is usually conducted no farther than 10 feet away from the containment area, but this may vary if visual monitoring indicates that dust may have spread farther than 10 feet. If deviations from the worksite preparation plans described below are contemplated, then the performance of the containment system should be determined by a person certified in the State to collect dust samples. This flexibility permits owners to select the most cost-effective strategy while also protecting the public health and the environment.

B. Interior Worksite Preparation

These *Guidelines* provide, in Table 8.1, two sets of recommendations for *interior* work (not including windows) – one for “low-dust” jobs and one for “high-dust” jobs. (Recommendations for window work are provided in Section III.D, below.)

The approach of categorizing a project by the amount of dust it may generate (“high dust” / “low dust”), in order to describe suitable measures taken to protect the safety of the housing for each category, is analogous to the approach OSHA uses for characterizing worker exposures to lead and the suitable protective measures for workers taken for exposures in each worker airborne lead exposure range, although the residential protection “high” / “low” distinction is defined based on the spread of leaded dust, rather than the airborne dust levels, and is less quantitative.

A low-dust job is work that creates a small amount of dust that will not spread beyond 6 feet from the painted surfaces being disturbed. A high-dust job creates a large amount of dust that is expected to spread beyond 6 feet from the working surfaces. Work disturbing more than 10 square feet of painted surface per room is likely to be a high-dust job, while work that disturbs less than 10 square feet will probably be a low-dust job. These are very rough indicators, however. Dust spread depends on the elevation of the work surface, air movement, and whether methods are used to dampen dust dispersal as well as reduce the amount of paint being disturbed and the amount of dust being generated.


All work involving lead-based paint should be performed in a manner that minimizes all dust production. ***High-dust operations should be avoided if at all feasible.*** All work should be designed to reduce all dust generation to protect children, workers and residents using work practices and procedures such as wet work practices and the use of tools with attached HEPA-vacuum exhaust.

**Table 8.1 Interior Worksite Preparation
(Not Including Windows)**

Note: This table does not relieve employers from the exposure assessments and other requirements of OSHA regulations. For example, employers are responsible for determining whether a work area is at or above the Action Level or Permissible Exposure Limit for airborne lead, and undertaking any required engineering controls, administrative controls and personal protective equipment controls.

Description	Low-Dust Jobs	High-Dust Jobs (High-dust operations should be avoided if at all feasible.)
Typical Types of Work	<p>A low-dust job creates a small amount of dust that will not spread beyond 6 feet from the painted surfaces being disturbed, depending on the type of work performed. Work that disturbs less than 10 square feet of painted surface per room will probably be a low-dust job, again depending on the type of work performed. The following tasks are also generally considered low-dust jobs: routine repairs, such as re-hanging doors, replacing or repairing door locks, patching small holes in walls, small electrical repair jobs, and routine repainting that involves a small amount of wet scraping and/or wet sanding for surface preparation. Enclosure and encapsulation may be low-dust jobs if little surface preparation and disturbance of paint is required.</p>	<p>A high-dust job creates a large amount of dust that is expected to spread beyond 6 feet from the working surfaces, depending on the job. Work disturbing more than 10 square feet of painted surface per room is likely to be a high-dust job. The following are also generally considered high dust-generating activities: demolition of painted surfaces, including removal of interior walls, paneling, baseboards, door casings or frames, cabinets, flooring, or ceilings; pulling up old wall-to-wall carpeting improperly (see Chapter 11); paint scraping of large areas, such as a whole room, even when done wet; using a circular or reciprocating saw on painted surfaces; and removing dry residue and paint after using chemical strippers.</p>
Resident Location	<p>Residents must be outside the rooms where the work will be done until after final clearance is achieved (or, if cleaning verification is being conducted, after the cleaning is verified), i.e., after results of dust sampling show that dust-lead levels are below applicable standards (or visual examination of the cleaning verification wipe indicates that the cleaning is verified).</p> <p>If the housing or the work is federally-assisted, the resident relocation provisions of HUD’s Lead Safe Housing Rule (LSHR) must be followed. The LSHR requires residents to be temporarily relocated to a suitable, decent, safe, and similarly accessible dwelling unit that does not have lead-based paint hazards – see Section IV.B,</p>	<p>SAME AS FOR LOW-DUST JOBS, EXCEPT that HUD recommends temporary relocation of residents to a suitable, decent, safe, and similarly accessible dwelling unit that does not have lead-based paint hazards, for jobs lasting more than five consecutive calendar days even if neither the housing nor the work is not covered by the LSHR.</p>


Description	Low-Dust Jobs	High-Dust Jobs (High-dust operations should be avoided if at all feasible.)
Resident Location (continued)	<p>below, on how to determine if the relocation unit is acceptable – except in certain situations, including those below. It requires relocation of residents for jobs lasting more than five consecutive calendar days and has other requirements (See Appendix 6 and the LSHR at 24 CFR 35.1345(a)(2)).</p> <p>If residents are not being temporarily relocated, the worksite must be contained and the work and clearance or cleaning verification, if they will be conducted, will not be completed in one 8-hour work day, residents must have lead-safe access to sleeping areas, and bathroom and kitchen facilities. If bathrooms are not accessible, residents should be relocated, unless alternative arrangements can be made (e.g., use of a neighbor’s bathroom).</p> <p>If construction will result in other hazards (such as exposed electric wires), then residents should be relocated.</p> <p>The dwelling unit and the worksite should be secured, and occupants’ belongings protected from contamination.</p>	
Containment and Barrier Systems	<p>To catch dust, paint chips, and other debris created by the work, place a single layer of impermeable protective sheeting (e.g., plastic) on the floor extending at least 6 feet out in all directions from each painted surface being disturbed. Workers should extend protective sheeting farther if they think dust generated by the work will spread, or in fact is spreading, beyond 6 feet.</p> <p>When dust and debris spread beyond 6 feet, workers should follow high-dust methods, depending on the job.</p> <p>If work on the flooring is part of the job, it is generally not necessary to put protective</p>	<p>Place two layers of protective sheeting on the entire floor of rooms where work is being done, in passageways used by workers going to and from the work area, and other areas used for storage of tools or debris. Two layers of protective sheeting should be used for all jobs in which damage to the sheeting is likely. (See Figure 8.8.) Usually the top sheet will be damaged and the bottom sheet will protect the floor.</p> <p>Torn or punctured sheeting should be repaired each day.</p> <p>Protective sheeting on floors should be a heavy-duty, disposable, impermeable</p>


Description	Low-Dust Jobs	High-Dust Jobs (High-dust operations should be avoided if at all feasible.)
<p>Containment and Barrier Systems (continued)</p>	<p>sheeting on the floor if the non-floor work is low dust.</p> <p>Protective sheeting on floors should be a heavy-duty, disposable, impermeable covering, such as polyethylene or vinyl plastic sheeting to resist tearing or puncture during the work. Plastic sheeting of 6 mils thickness is generally recommended for floors, but a thinner grade may be satisfactory for jobs of short duration with light traffic and no abrasion. Adhesive-backed floor protection films may be useful. Protective sheeting on floors must be able to withstand vacuuming the work area. Do not use cloth canvas drop cloths; they can transfer retained leaded dust from job to job.</p> <p>Do not track dust off the protective sheeting onto unprotected flooring. Workers and others leaving the work area must clean themselves before they do in order not to track dust off of plastic sheeting. Wear disposable non-skid shoe covers ("booties") when on protective sheeting and remove them each time you step off the sheeting. Alternatives to using booties are: (1) wipe both the top and bottom of your shoes with a damp paper towel each time you step off the sheeting;</p> <div data-bbox="444 1423 948 1835" style="text-align: center;">  </div> <p>FIGURE 8.8 Floor plastic in work area.</p>	<p>covering, such as polyethylene or vinyl plastic sheeting of 6 mils or greater thickness to resist tearing or puncture during the work. . Adhesive-backed floor protection films may be useful. Protective sheeting on floors must be able to withstand vacuuming.</p> <p>Workers and others leaving the work area must clean themselves before they do in order not to track dust off of plastic sheeting. Lighter impermeable sheeting, such as "painter's poly," may be used to protect immovable objects within the work area. Do not use cloth drop cloths; they can transfer retained leaded dust from job to job.</p> <p>If only a few rooms in a dwelling unit are being treated, install protective sheeting with a simple airlock flap on doorways to avoid having to clean and clear the entire dwelling. Even if the entire dwelling is to be cleaned and cleared, it is helpful to install protective sheeting in doorways to work areas to reduce the spread of dust.</p> <p>Simple airlocks are constructed using two sheets of protective sheeting. The first one is taped on the top, the floor, and both sides of the doorway with a vertical fold in the middle to allow slack. Next, cut a slit about 6 feet high down the middle of the plastic; do not cut the slit all the way down to the floor. Tape the second sheet of plastic, placed on the side of the first sheet facing the work area, across the top of the door only, so that it acts as a flap. The flap should open into the work area. (See illustrated guidance on this method in the <i>Lead Paint Safety Field Guide</i> (HUD, 2001), page 46.)</p> <p>Doorways within a containment area need not be sealed if the work area is isolated from the rest of the unit. If the entire dwelling unit is being treated, cleaned and cleared, doorways need not be sealed.</p>

Description	Low-Dust Jobs	High-Dust Jobs (High-dust operations should be avoided if at all feasible.)
<p>Containment and Barrier Systems (continued)</p>	<p>(2) clean the bottom of your shoes using a tack pad (a large sticky pad that is taped to the protective sheeting and helps remove dust) every time you step off the sheeting; and (3) remove shoes every time you step off the protective sheeting. The drawbacks to these alternatives are: (1) heavily treaded work boots may be difficult to clean; (2) the effectiveness of the tack pad may become compromised after a period of use; and (3) going without shoes in non-work areas is risky to the feet.</p> <p>A physical barrier should be placed at doorways to prevent inadvertent access by residents. If the work and collection of clearance dust samples will not be completed in one day, there should be an overnight barrier that is locked or firmly secured to prevent access to rooms where work is being done (see Figure 8.9). Children should not have access to protective sheeting because of the suffocation hazard.</p> <p>All personnel, tools, and other items, including the exteriors of containers of waste, must be kept free of dust and debris before leaving the work area.</p>  <p>FIGURE 8.9 Plastic barrier between living space and work area.</p>	<p>Place protective sheeting on the floors of passageways to be used by workers going from high-dust work areas to the outside. This facilitates daily cleanup of the work areas and encourages workers to use the protected passageways. Do not track dust off the protective sheeting onto unprotected floor. Wear disposable non-skid shoe covers (“booties”) when on protective sheeting and remove them each time you step off the sheeting. Alternatives to using booties are: (1) wipe both the top and bottom of your shoes with a damp paper towel each time you step off the sheeting; (2) clean the bottom of your shoes using a tack pad (a large sticky pad that is taped to the protective sheeting and helps remove dust) every time you step off the sheeting; and (3) remove shoes every time you step off the protective sheeting. The drawbacks to these alternatives are: (1) heavily treaded work boots may be difficult to clean; (2) the effectiveness of the tack pad may become compromised after a period of use; and (3) going without shoes in non-work areas is risky to the feet. If the work and clearance will not be completed in one day, there should be an overnight barrier that is locked or firmly secured to prevent access to rooms where work is being done. Children should not have access to protective sheeting (suffocation hazard).</p> <p>All personnel, tools, and other items, including the exteriors of containers of waste, must be kept free of dust and debris before leaving the work area.</p>

Description	Low-Dust Jobs	High-Dust Jobs (High-dust operations should be avoided if at all feasible.)
<p>Warning Signs</p>	<p>If residents are present, place warning signs at the entry to work-area rooms or the containment area and at each main and secondary entryway to the building or, for work in multi-family housing, the unit; if the work is to be done in a common area, place the warning signs at the entries to that area (see Figure 8.10 and 11). Warning signs should be in the language(s) understandable to residents and workers. Recommended wording is: "Warning. Lead Work Area. Poison. No Smoking or Eating." Wording can be adapted as appropriate to project-specific conditions. The EPA's RRP rule has sign requirements for renovations (see Appendix 6).</p> <p>OSHA warning signs are required when worker exposures exceed OSHA's permissible exposure limit for airborne lead; see Chapter 9.</p> <div data-bbox="444 1094 948 1423" data-label="Image"> <p>A yellow warning sign is posted on a wooden staircase railing. The sign reads: "WARNING Do Not Enter EMP WORK AREA. KEEP WORKERS OUT OF LEAD WORK AREA. To prevent the release of LEAD contamination and possible exposure to dust, please do not enter until work has been completed and the area has been inspected." The sign is secured with a blue pushpin.</p> </div> <p>FIGURE 8.10 Interior warning sign.</p>	<p>SAME AS FOR LOW-DUST JOBS.</p> <div data-bbox="980 432 1484 1100" data-label="Image"> <p>A yellow warning sign is posted on a wooden door. The sign reads: "WARNING LEAD HAZARD KEEP OUT. To prevent the release of LEAD contamination and possible exposure to dust, please do not enter until work has been completed and the area has been inspected." The door is partially covered by white plastic sheeting.</p> </div> <p>FIGURE 8.11 Exterior warning sign for project shown in Figure 8.10</p>

Description	Low-Dust Jobs	High-Dust Jobs (High-dust operations should be avoided if at all feasible.)
Ventilation	<p>To contain dust, air movement should be minimal in work areas while painted surfaces are being disturbed and while cleaning is being conducted.</p> <p>Fans should be turned off, and windows should be closed. The HVAC system should be turned off. Forced-air duct vents within the work area of surfaces being treated and at least 6 feet beyond should be covered with protective sheeting and taped.</p> <p>Doorways in the work area must be closed, and covered with plastic sheeting or other impermeable material.</p> <p>(If volatile substances are to be used, such as certain types of paint strippers, a source of fresh air should be provided and manufacturer’s instructions followed in order to ensure protection of the workers. Open windows usually are the available source of fresh air. An alternative source of fresh air to open windows is negative air; see Section V, below. If windows are to be opened, then, in order to minimize dispersal of leaded dust, open as few windows as need be to protect the works, use high-dust containment methods (see above), and conduct the work with the volatile substances first followed by other paint-disturbing work with the windows closed.)</p> <p>Painting can be done with windows open and HVAC system on, provided the work has passed clearance or cleaning has been verified, and paint fumes will not be carried to other areas causing danger or discomfort.</p>	<p>SAME AS FOR LOW-DUST JOBS.</p>

Description	Low-Dust Jobs	High-Dust Jobs (High-dust operations should be avoided if at all feasible.)
Furniture and Resident's Belongings	<p>Remove drapes, curtains, furniture, rugs, and other resident belongings from the work area, that is, to at least 6 feet away from surfaces being treated, and cover and seal with taped impermeable protective sheeting all large furniture and other large items that cannot be moved (see Figure 8.12). If there will be air movement due to open windows, remove all belongings from rooms in which work is being done or cover and seal with taped protective sheeting.</p>	<p>SAME AS FOR LOW-DUST JOBS.</p>  <p>FIGURE 8.12 Items that are too large to move should be sealed completely and taped.</p>
Cleanup	<p>Daily cleanup: The purposes of daily cleanings are: (1) to help assure that workers will not be exposed to accumulated dust-lead; (2) to make it more likely that the work area will pass the initial clearance examination after one final cleanup; and (3) to protect residents after final cleanup.</p> <p>If residents are present in part of the dwellings, daily cleaning provides protection against accidental resident exposure, especially after work hours. The longer the job lasts, the more important the daily cleaning.</p> <p>The "daily" procedures below apply to each work shift if the work is being done on more than one shift.</p> <p>Daily cleaning includes: (1) wrapping or bagging debris and storing same in a secure area; (2) vacuuming (using HEPA vacuums throughout) protective sheeting on floors and belongings; (3) vacuuming other horizontal surfaces within at least 6 feet of treated surfaces; (4) vacuuming and wet cleaning of floors used as passageways to the work areas (except that wet cleaning is not necessary if passageways can be reliably secured during non-work hours) any</p>	<p>NEARLY THE SAME AS FOR LOW-DUST JOBS, except that cleaning of horizontal surfaces should extend through the entire containment area, not just within 6 feet of the work surfaces.</p>

Description	Low-Dust Jobs	High-Dust Jobs (High-dust operations should be avoided if at all feasible.)
Cleanup (continued)	<p>areas used for storage of tools and debris; and (5) patching and repairing of protective sheeting and simple airlock flaps as needed.</p> <p>Contaminated objects need to be properly wrapped before removing from the work area (see Figure 8.13).</p> <p>Do not store dust, debris and other waste inside the dwelling overnight. Instead, transfer the waste to a locked secure area or container that prevents release of, and access to, dust and debris.</p> <p>Final cleanup: The final cleanup includes: (1) cleaning and removal of protective sheeting from the floor and belongings and discarding of same; (2) vacuuming and wet cleaning all horizontal surfaces (including window troughs) within at least 6 feet in all directions of all disturbed painted surfaces (cleaning beyond the 6 feet perimeter is recommended as a safety precaution if dust generated by the work may have spread beyond 6 feet); (3) cleaning all window troughs; and (4) vacuuming and wet cleaning the floor in adjacent areas used as pathways to the work areas. See Chapter 14 for further guidance on cleaning before, during, and after hazard control and other paint-disturbing work.</p>	 <p>FIGURE 8.13 Removal and wrapping contaminated carpet.</p>
Monitoring Effectiveness of Containment	<p>The project supervisor must make sure that dust generated by paint-disturbing work has not spread beyond the containment area.</p> <p>Conduct visual monitoring while paint-disturbing work is underway and while workers are stepping off the protective sheeting on the work-area floor.</p> <p>Checking the quality of the effectiveness of containment is optional for low-dust jobs but is encouraged for low-dust jobs lasting longer than 5 consecutive days. (If the quality check is to be conducted, see the procedures for high-dust jobs.)</p>	<p>The project supervisor must make sure that dust generated by paint-disturbing work has not spread beyond the containment area.</p> <p>Conduct visual monitoring while paint-disturbing work is underway and while workers are stepping off the protective sheeting on the work-area floor.</p> <p>HUD recommends that the project supervisor (certified renovator) check the quality of the effectiveness of containment of high-dust jobs as follows:</p>

Description	Low-Dust Jobs	High-Dust Jobs (High-dust operations should be avoided if at all feasible.)
<p>Monitoring Effectiveness of Containment (continued)</p>		<ul style="list-style-type: none"> ◆ For high-dust jobs scheduled to be in containment for up to 5 consecutive days: <ul style="list-style-type: none"> — Supplement the project oversight with cleaning verification. — Specifically, at the end of each work day (or work shift if the work is being done on more than one shift), perform the cleaning verification of the floor of the living area outside the containment that is at greatest risk of contamination (usually the living area closest to the work area). <ul style="list-style-type: none"> ◆ It is essential that the cleaning verification be performed before daily cleaning to determine if the containment system was effective in protecting the occupants that day. ◆ For high-dust jobs scheduled to be in containment for more than 5 consecutive days, or turns out to take that long: <ul style="list-style-type: none"> — Supplement the project oversight with dust-wipe testing. — Specifically, a dust-wipe sample should be collected at the end of each work day (or work shift if the work is being done on more than one shift) from the floor of the living area outside the containment that is at greatest risk of contamination (usually the living area closest to the work area). <ul style="list-style-type: none"> ◆ It is essential that the sample be collected <i>before</i> daily cleaning to determine if the containment system was effective in protecting the occupants that day, and

Description	Low-Dust Jobs	High-Dust Jobs (High-dust operations should be avoided if at all feasible.)
<p>Monitoring Effectiveness of Containment (continued)</p>		<p>that the location of the sample not be known in advance to the person(s) or firm(s) conducting the job.</p> <ul style="list-style-type: none"> — Sampling, analysis and use of dust tests. <ul style="list-style-type: none"> ◆ Samples for this purpose should be collected by a certified risk assessor, lead-based paint inspector, or sampling technician. The wipe sample should be collected in accordance with Appendix 13.1, or similar protocol. ◆ Dust-wipe samples should be sent to a laboratory recognized for analysis of lead in dust by the National Lead Laboratory Accreditation Program (NLLAP) (or an EPA-authorized State/Tribal-required alternative). One-day service (or faster, if desired to expedite the project) should be ordered. ◆ Lead levels in the floor dust should be less than the applicable floor dust standard for clearance (the Federal standard as of the publication of this edition of these <i>Guidelines</i> is 40 µg of lead per square foot). ◆ If the dust-lead level is above clearance standards or if the cleaning is not verified, the person in charge should immediately: <ul style="list-style-type: none"> — Clean the areas represented by the failed clearance testing or cleaning verification.

Description	Low-Dust Jobs	High-Dust Jobs (High-dust operations should be avoided if at all feasible.)
<p>Monitoring Effectiveness of Containment (continued)</p>		<ul style="list-style-type: none"> — Review all elements of the worksite preparation and occupant protection for the job, make improvements where feasible (e.g., repairing torn contaminant barriers), and reaffirm strict compliance by all workers with lead-safety procedures. — If dust-lead levels are found to exceed the clearance standard a second time, residents must be relocated and must not be allowed to reenter the dwelling until final cleanup and documented compliance with clearance standards or cleaning verification is achieved. ◆ If a work-crew supervisor (certified renovator) can document that the containment is effective (that is, for the area outside containment that was checked, the wipe sample is below the dust-lead clearance standard, or the area passed cleaning verification) for 3 or more consecutive dwelling units in which the work crew used the same hazard-control techniques on high-dust jobs, then the frequency of checking high-dust jobs can be reduced to 1 in every 10 dwelling units for that supervisor.

C. Worksite Preparation for Exterior Paint-Disturbing Work

For exterior paint-disturbing work, worksite preparation is dependent on several factors: the amount of dust created; how high up the work surfaces are; how near the work surfaces are to other properties; weather conditions; the location of the residents; and whether people must pass in and out of the building during the work. A porch, balcony, or deck is considered to be exterior, unless it is enclosed by screens or windows, in which case it is considered to be an interior room for the purpose of worksite preparation. Only one set of instructions is provided because the same approach is used for low-dust and high-dust exterior jobs.

1. Resident Location

Residents may remain inside dwellings outside of which exterior work is being done, but must be away from the work area for the duration of the exterior project until final cleanup and exterior clearance have been completed. Alternatively, residents may leave their dwellings during workdays and return to the interior (not the exterior work area) after daily cleanup at the end of each workday (presuming the work is done during just the day shift), or residents may temporarily relocate for the duration of the project. Remaining residents must have lead-safe access to entry/egress pathways. (For longer-duration HUD-assisted interior work, the Lead Safe Housing Rule (LSHR) requires that residents be relocated; see Section IV, Temporary Relocation, below, Appendix 6, and the LSHR at 24 CFR 35.1345(a)(2).)

Workers should tightly close or seal windows, doors, and other building openings within 20 feet of surfaces being disturbed during exterior work. Remaining residents should be instructed not to open windows within 20 feet of ongoing work. Daily cleanup of horizontal surfaces within 20 feet of disturbed surfaces is essential.

2. Containment and Barrier System

Place one layer of disposable impermeable plastic (not landscape fabric, geotextiles, or cloth) protective sheeting (typically at least 6 mil thick to resist tears) on the ground, weighted down by heavy objects, and extending far enough from the work surfaces to adequately collect all falling paint chips and debris. EPA's RRP rule requires that the sheeting extend at least 10 feet in all directions beyond working surfaces when work is on the ground floor, or a sufficient distance to collect falling paint debris, whichever is greater, if feasible; these criteria are also appropriate for abatement work. As a general guide, if work is above the ground floor, sheeting should extend 20 feet. These distances apply unless an adjacent building or other obstacle interferes (see Figure 8.14, and the following paragraph). Being up high and exposed to wind currents, dust created by scraping an exterior above the ground floor has the potential to contaminate a large area. Scaffolding with vertical shrouding or staging on pump jacks are other options. Vertical shrouding on scaffolding generally should be used if work is close to a sidewalk, street, or another property, or if work will be conducted at a height of more than three stories.

If an adjacent building, building wing, or property line is closer than the distance the sheeting should extend (10 feet or 20 feet, as applicable), provide as much protection as feasible. For example, if the adjacent building is on the same property as project building, or is owned by the same owner, protective sheeting should be placed on the facing side of the adjacent building within 10, or 20, feet of the work area, as described above.



FIGURE 8.14 Exterior containment of polyethylene sheeting lines the narrow walkway between two houses. Notice the abatement worker in the background.



FIGURE 8.15 Exterior containment on building and window; ladder kept on plywood.

(See figure 8.14) If the adjacent building is owned by another owner, an effort should be made to coordinate with that owner to allow protective sheeting to be installed on that owner’s ground and building.

Tape and/or staple protective sheeting to wood siding or ribbon board so there are no gaps between sheeting and building. A wood strip may have to be attached to a masonry wall. Build a curb at the edge of the protective sheeting to prevent contaminated runoff and reduce blowing of debris off the sheeting. If power washing is planned, extra care is needed to contain runoff. Weigh sheeting down with two-by-fours or similar objects. In hot weather, take care not to burn out vegetation under plastic sheeting. White plastic is less harmful than black or clear. Do not place ladder feet on top of plastic sheeting. Cut slots in the sheeting and place ladder feet on the ground and repair slots with tape when the ladder is moved. Alternatively, place a large, sturdy piece of plywood on the sheeting and put the ladder on the plywood (see Figure 8.15). If power washing is planned, a certified abatement supervisor with experience with such methods should design special containment and water-collection measures.

Keep all windows, doors, and other building openings within 20 feet of working surfaces (including openings in adjacent buildings) tightly closed or sealed with protective sheeting unless entry to the interior is needed. If possible, require use of an alternative entryway for existing entryways closer than 20 feet. If an entrance must be used that is closer than 20 feet, place a shroud above and on the sides of the entrance and install a simple airlock flap at the door (see the Containment and Barrier Systems row of Table 8.1, above). In addition, install a tack pad inside the door so shoes can be cleaned off.

If residents are remaining in the dwellings or returning at the end of the day, at least one lead-safe entryway must be made available. Do not work on front and rear porches at the same time unless there is a third entry.

3. Playground Equipment, Toys, Sandbox, and Outdoor Furniture

Remove all movable items to at least a 20-foot distance from working surfaces. Items that cannot be readily moved to a 20-foot distance must be sealed with taped protective sheeting.

4. Security

Erect temporary fencing or barrier tape at a 20-foot perimeter around working surfaces (or less if distance to the next building or sidewalk is less than 20 feet). If practical, require use of an alternative entryway for any entrance within 20 feet of working surfaces. If not, install a shroud, simple airlock flap, and tack pad, as described above. Use a locked metal bin, locked covered truck, or locked room to store debris securely before disposal.

5. Warning Signs

Post warning signs on the building and at a 20-foot perimeter around the building (or less if distance to next building or sidewalk is less than 20 feet). Warning signs should be in a language understandable to residents (see Figures 8.10 and 8.11). Recommended wording is: “**Warning. Lead Work Area. Poison. No Smoking or Eating.**” Some states have specific sign requirements, and wording can be adapted as appropriate to project-specific conditions. See EPA’s RRP rule for sign requirements for renovations. You may also use barrier tape (see Figure 8.16).

If an employee’s exposure to lead is above the permissible exposure limit (PEL) of $50 \mu\text{g}/\text{m}^3$ of airborne lead averaged over an 8-hour period, warning signs must be posted at in each work area. The mandatory language for these signs is shown in Chapter 9, Section III.

6. Weather

Do not conduct exterior work if wind speeds are greater than 20 miles per hour or if dust and debris cannot be adequately contained. If chips and debris are blowing off the protective sheeting, work must stop until the wind dies down or adequate containment is installed. In the meantime, cleanup must occur before rain, snow or other precipitation begins.



FIGURE 8.16 Example of barrier tape used as an occupant protection measure.

7. Cleanup

Cleanup should be conducted at the end of each workday, the end of each work shift when work is being done on more than one shift, or when workers are finished in one exterior work area and moving to another, whichever is soonest.

- ✦ Remove debris and paint chips and wet clean all horizontal surfaces on the building (e.g., exterior window sills and exposed window troughs, porches, balconies, railings) within 20 feet from working surfaces.
- ✦ Remove debris and paint chips from the protective sheeting.

- ◆ Dispose of water that has collected on the protective sheeting in accordance with local rules (usually flushing it down a toilet is acceptable, but do not dump it down a storm drain or a sink, tub, or shower).
- ◆ Clean (either vacuum or wet clean) the protective sheeting.

After cleaning:

- ◆ Fold protective sheeting inward to avoid contamination of the environment. Do not reuse protective sheeting.
- ◆ Visually inspect for and remove any debris and paint chips from the ground, walkways, gardens, shrubbery, and play areas. Refer to Chapter 14 for further guidance on cleaning before, during, and after hazard control and other paint-disturbing work.
- ◆ Do not leave debris or protective sheeting out overnight (or after the final work shift of the day).
- ◆ Keep all debris, protective sheeting, and other disposable material in a secured area that will not allow release of the material, until final disposal. (See Section III.C.4, above.)

D. Worksite Preparation for Windows

Because windows have both interior and exterior sides, workers should protect both interior and exterior spaces from contamination when repairing or replacing old windows or performing interim controls or abatement of lead-based paint hazards on windows. Most window repair and window

interim control work can be considered low-dust work if paint surfaces are misted before being scraped and prepared for repainting, and scored before removing small parts like stops and parting beads. However, if the entire window, including the jamb casing, stool, and apron, is being replaced, workers should prepare for high dust generation.

An important consideration in planning dust containment for window work is that the windows may be open during most of the work, creating the potential for wind-blown dust into the interior. Therefore, workers should follow the guidance given in Table 8.1 for interior worksite preparation that protects against wind-blown dust, if window openings are not closed, either by closing the storm window, if present and operable, or by covering the opening with protective sheeting (see Figure 8.17), or if the work is such that the window will not be opened, such as if it is for repair of paint on the underside of the interior sill (see Figure 5.14) or the face of the window frame.

If working on windows from the outside, it may be possible to tack or tape protective sheeting to the interior window casing or wall, completely covering the window opening, and achieve sufficient interior worksite protection. If the interior of the unit is adequately protected, the interior would not need to undergo a clearance examination. Care must be taken in preparation, because attaching sheeting to the interior wall may cause unacceptable damage to the wall surface unless appropriate tape, such as blue painter's tape, is used.



FIGURE 8.17 Pre-cleaning window with HEPA vacuum.

If the window is not sealed to the interior of the unit before it is removed from the outside, interior cleanup and clearance would still be necessary. Also, exterior worksite preparation, as described in Section III.C, is always required for window removal from the outside, and the protective sheeting must be removed and disposed of with care.

Workers should follow other guidance provided in Table 8.1, above, for resident location, barriers, signs, security, ventilation system, furniture protection, weather, cleanup, and clearance.

If working from the inside and there is no operable storm window, workers may be able to tack and tape protective sheeting to the outside window surround or wall, completely covering the window opening, so that dust and debris will not fall on exterior surfaces other than the window sill. If there is an operable storm window, workers may either install the sheeting as described above, or put tape across the gaps between the storm window sashes and frame, and between storm window sashes. This will preclude the blowing of dust into the interior, and it will also provide adequate protection of the exterior so further exterior worksite preparation may not be necessary. (Of course, the protective sheeting must be removed and disposed of with care, and exterior cleanup and visual assessment for dust, debris and residue should still be done.) If this method is not used, the interior and preparation based on either low- or high-dust generation, as appropriate, and protecting against wind-blown air. As noted in Section III.B and Table 8.1, high-dust operations should be avoided if at all feasible; planning for window replacement projects should include sufficiently stringent precautions and controls to minimize the likelihood of the project becoming a high-dust project.

E. Worksite Preparation for Soil-Lead Hazard Controls

Disturbing lead-contaminated soil poses the risk of generating dust that can contaminate building surfaces, both interior and exterior, and adjacent yard and paved areas. The most effective way to reduce dust generation is to continually dampen the soil as it is being disturbed. This should always be done. However, workers should take care not to over-water the soil. Excessive dampening of the soil is likely to cause runoff and require the use of major curbing methods, such as bales of hay.

If the soil-lead hazard control method being used involves minimal disturbance of the bare soil (as may be the case when the soil is covered with bark, mulch, sod, gravel, landscaping fabric, paving stones, or asphalt paving) and if the soil is kept damp during the work, adequate worksite preparation is to place protective sheeting on ground surfaces, porches, etc. within at least 6 feet of the work area on all sides and to tightly close or seal all building openings within at least 10 feet. These distances are minimum guidance. Supervisors should visually monitor dust spread and adjust the containment if needed during a particular project.

If, however, the soil is being shoveled, cultivated, rototilled, or otherwise subjected to major disturbance, protective sheeting on the ground should extend at least 10 feet from the soil, and all building openings within 20 feet of the work area should be tightly closed or sealed. Of course, this should be accompanied by periodic dampening of the soil during the work.

Perform daily and final cleanup. Follow the cleanup guidance for exterior paint-disturbing work (see Section III.C.7, above), except, of course, references to paint chips apply only if the soil was visibly contaminated with them.

IV. Temporary Relocation

Temporary relocation means that occupants currently living in a dwelling intend to return to that unit once the work is finished. There are many possible variations – from requesting residents to vacate the unit for just one workday (leaving their belongings in the unit and returning at the end of the day) to moving everything out for several weeks or months. Temporary relocation of residents can be disruptive, complicated, and costly. Careful planning of relocation pays off in good client relationships, cost containment, and efficiency in conducting the work. This section provides answers to some of the most common questions about relocation.

A. When Is Relocation Necessary and What Are the Options?

Temporary relocation of residents is generally recommended when work is undertaken that will disturb painted surfaces known or suspected to contain lead-based paint and the work will occur throughout much of the dwelling over several days. (If the work does not disturb lead-based paint, dust-lead hazards or soil-lead hazards, relocation is usually not necessary as a lead-exposure protection measure.) Temporary relocation is clearly necessary if residents cannot have safe access to bathrooms, sleeping areas, and kitchen facilities (or alternative eating arrangements) during non-work hours.

Safe access includes the absence of other significant safety, health, or environmental hazards in addition to lead hazards (e.g., toxic fumes, on-site disposal of hazardous waste, or exposed electrical wiring).

There are, however, several exceptions and options that may be considered in deciding whether it is necessary for residents to temporarily relocate and, if so, for how long and whether furniture and other belongings must be moved.

1. Work Is a Small Area

If only a small amount of paint is being disturbed, that is, an amount below HUD's *de minimis* threshold for HUD-assisted projects, or EPA's minor repair and maintenance work threshold for unassisted projects, special measures to protect residents from exposure to leaded dust are not required (see Section II.A, above, for a definition of the HUD and EPA area threshold definitions). However, basic precautions are strongly recommended. These include: never using prohibited paint-removal practices (see Chapter 11, Section II.D.1), and cleaning the work area thoroughly after work is completed. Also, if a child under age 6 resides in or accesses the unit or area, keep residents out of the work area until after final cleanup.

2. Work Is Only on the Outside

Residents and their belongings may remain inside the dwelling if the work is only on the exterior and building openings (windows, doors, vents) within 20 feet of disturbed paint surfaces are tightly closed or sealed and cleaned afterward, *and* an entryway is provided that is free of dust-lead hazards, soil-lead hazards, and debris.

3. Work and Clearance Take Only One Day

If the work, final cleanup, and clearance can be achieved (i.e., results of dust sampling received from the laboratory and found to be acceptable) in one work day, residents need to be out of

the work area or the unit only for that day and can return with full access to the unit at the end of the day. As a practical matter, however, completion of the work and achievement of clearance in one day may not be a realistic goal. It usually takes an additional day to get the results of the laboratory analysis. However, as discussed in Unit IV.E, below, methods (including portable X-ray fluorescence (XRF) analysis and anodic stripping voltammetry) exist for reliably analyzing wipe samples on-site instead of in a fixed laboratory, which may provide testing results much more quickly than fixed-laboratory analysis by avoiding transportation of the samples to the laboratory and handling time within the laboratory. A laboratory that is recognized under NLLAP for mobile source lead dust analysis may be used for clearance. This approach may be particularly helpful for multi-family projects, in which a work crew may be working on a unit while the clearance test analysis is being performed on the crew's preceding unit. Sometimes work areas do not pass clearance the first time, so recleaning and additional dust sampling is required, which may require an additional day, even if the dust-lead analysis is rapid.

4. Work Area Is Limited and Work Is of Short Duration

Relocation is usually not necessary or is necessary only for workday hours if the work: takes less than five days; is being conducted in only one or two rooms; and if exclusion from those rooms does not preclude safe resident ingress and egress to the unit and safe access to kitchen (or alternative eating arrangements), bathroom, and sleeping areas. Furniture and other belongings can be moved out of the workrooms, or covered and sealed with protective sheeting and tape. It is recommended, however, that residents who remain in their units or vacate only during workday hours while such limited area work is being conducted be required to sign a statement that: (1) they understand that there may be lead-based paint hazards in both specified work areas and traffic areas used by workers outside the work areas in spite of a thorough cleaning of such areas; and (2) they agree not to enter the work areas until they are notified by a specified responsible party that the areas have passed clearance (or cleaning verification, if applicable).

Theoretically, such arrangements, in which residents remain in the unit or are absent during the workday but return for the night, can continue for an extended period of time. As a practical matter, however, there are limits to how long people will comply with such procedures. **HUD regulations pertaining to housing receiving Federal assistance for the residents to live there or for the work allow this type of arrangement to continue for no more than five calendar days (24 CFR 35.1345(a)(2)(iv)).** If residents are to be allowed back in the unit during the night, it is necessary that workers thoroughly clean, at the end of each work day, not only the work areas but also the floors of the pathways used by workers to and from the work areas. Installing protective sheeting on these pathways facilitates cleaning. If a decontamination area is used in a large multi-family project, cleaning is necessary only from the work areas to the decontamination area.

5. Exception for Elderly Residents

Because of the added difficulties that may accompany the relocation of elderly residents, it is acceptable to make special exceptions to normal relocation policy for them. This exception is acceptable for work to be done in housing for the elderly. (As stated in the Lead Safe Housing Rule, housing for the elderly means retirement communities or similar types of housing reserved for households composed of one or more persons 62 years of age or more, or other age if recognized as elderly by a specific Federal housing assistance program; it is not merely housing occupied by the elderly.) If elderly residents are permitted to stay in their units when temporary relocation would normally be required, they should be fully informed about

the nature of the work and the hazards that may be generated; they should be required to sign an informed consent form before the work begins; and, of course, children should not be permitted in the unit. If the resident declines to sign, the property owner and the contractor will have to determine whether or not the job will be performed. Figure 8.18 is an example of an informed consent form. **No such policy or form should be implemented without advice from the contractor’s legal counsel.**

Figure 8.18 Sample Informed Consent Form for Residents of Housing for the Elderly.

I/We, the undersigned,

choose to remain in my/our home while _____
(Description of work)
 is being performed;

or

choose to relocate to another unit while the work is being performed;

and

I/We have made this choice having read and understood the following:

1. I am/At least one of us is at least 62 years old.
2. My/Our home was built before 1978 and is housing designated for the elderly.
3. I/We have received the pamphlet *“Protect Your Family From Lead in Your Home”* and the pamphlet *“Renovate Right: Important Lead Hazard Information for Families, Child Care Providers and Schools”* (*“Renovate Right”*), and am/are aware of the health hazards that are posed by lead-based paint in general and that can be created by renovation, painting, repair or lead abatement work
4. I/We have been given a description of work that will be done in my/our home and understand that during the course of the work, lead hazards may be created in the work area. These hazards will be taken care of before the job is considered complete.
5. I/We may stay in my/our home but I/we may not enter the work area while work is being performed.
6. I/We will not allow children under age six or women of childbearing age to visit or reside in my/our home while work is being done, because visiting or residing may pose a health risk.
7. I/We waive rights to all damages. I/We agree to hold harmless

(The housing owner, public housing agency, or other responsible party)

for any damages due to lead poisoning that occur as a result of the work on these premises.

Name	Date	Name	Date
------	------	------	------

B. What Relocation Units Are Acceptable?

Relocation dwellings should be acceptable to residents so that they will not attempt to return to their own dwellings during paint-disturbing work. Generally, dwellings serving as temporary relocation units should, at minimum, meet applicable housing codes. If they are HUD-assisted, they should meet the regulatory standards, e.g., housing quality standards (24 CFR 982.401) or physical condition standards (24 CFR 5.703). If they were constructed before 1978 and are not HUD-assisted, they should also pass a visual assessment; that is, they should have no deteriorated paint and no visible dust or debris. If a dwelling constructed before 1978 is to be occupied by a relocated household for more than 100 days or if it is used repeatedly for temporary relocation (such as a lead-safe unit operated by a community program) with occupancy periods totaling more than 100 days, it should be found to be lead-safe by a risk assessor before the first occupancy begins, and at least annually thereafter. In addition, these units should be adequately equipped with furniture, cooking facilities, refrigerators, televisions, and toys (except for items that will be moved with the residents). Relocation is usually a substantial undertaking, involving not only the movement of people and their possessions, but also the coordination of mail, phone, school, and community changes. Whenever possible, children should continue to attend the same school during the relocation period, even though this may involve finding special transportation. Due to their complex nature, relocation considerations may dictate the scheduling of the project. Destination options include staying with relatives or friends, a designated relocation unit owned or leased by a local organization, a hotel or motel (usually the most costly and least desirable option for families with children), or a temporarily vacant unit in the same multi-family property. If the Lead Safe Housing Rule requires relocation of the family to a temporary unit during work, the unit to which the family is relocated must not have lead-based paint hazards (24 CFR 35.1345(a)(2)).

C. Allowing Reoccupancy after Interim Clearance

In some rehabilitation jobs, it may be efficient to conduct all lead hazard control or abatement work first, using qualified firms and workers, and then, following a preliminary or "interim" clearance (see Chapter 15 for details), conduct other rehabilitation work that will not affect lead-based painted surfaces with firms or workers who are not certified for lead hazard control work or renovation work that may affect lead-based painted surfaces. Clearance is conducted after the hazard control or abatement work to document that the contractor has completed the job correctly. This clearance is sometimes called "interim clearance." The question may arise in such cases whether temporarily relocated residents can return after interim clearance is achieved but before all rehabilitation is finished. The general answer depends on the nature of the post-clearance rehabilitation work and how much dust will be created. Additional guidance is provided below. However, for units controlled under HUD's Lead Hazard Control grant program, and some local regulations, units in which rehabilitation work occurs following lead hazard control must pass a final clearance prior to re-occupancy by the residents (see the HUD Office of Healthy Homes and Lead Hazard Control's Policy Guidance 99-01, posted at: http://portal.hud.gov/hudportal/HUD?mode=disppage&id=POLICY_GUIDANCES).

Most rehabilitation activities generate a lot of dust. In old houses, such dust may be contaminated with lead even if the components being disturbed are not coated with paint that is considered lead-based paint under Government regulations. There are two reasons for this: (1) existing paint that is not lead-based paint can still contain lead; (2) dust under or behind floors or walls can be contaminated from accumulations that are decades old. Therefore, in old homes that have been found to contain lead-based paint hazards, it is recommended that there be a final clearance after all paint-disturbing work is

finished, even if there was an interim clearance previously and the follow-up work did not disturb lead-based painted surfaces. For this reason, it is recommended that relocated residents usually not return until after all paint-disturbing work is completed and final clearance is achieved.

If, however, the paint-disturbing work performed after interim clearance will disturb less than a *de minimis* amount of paint (see Section II.A, above), final clearance is not necessary and residents can return after the interim clearance. If the paint being disturbed exceeds the *de minimis* but is known not to be lead-based paint, residents can return. But in each case, i.e., if the *de minimis* applies or if the paint is not classified as lead-based paint, the precautions listed at the end of Section II.A, above, should be followed when disturbing paint in pre-1978 housing, unless it is known that all layers of disturbed paint have been applied after 1977: (1) never use the prohibited methods of paint removal that are described in Section III.C.1 of Chapter 6, or Section II.D of Chapter 11, and (2) when disturbing paint *in housing occupied by children of less than 6 years of age*, clean the work area thoroughly after finishing, preferably with a HEPA vacuum and wet cleaning, and always keep residents out of the work area while work is underway and until after the unit has passed clearance.

The approach above also applies to work that is not being cleared but is having its cleaning verified, that is, the work is covered by EPA's RRP Rule but not HUD's Lead Safe Housing Rule, and the paint-disturbing work performed after interim cleaning verification has been passed will be a minor repair and maintenance activity.

D. Who Should Pay?

If relocation of tenants is required as a result of an activity assisted by the Federal Government, the requirements of the Uniform Relocation Act (formally, the Uniform Relocation Assistance and Real Property Acquisition Policies Act of 1970 (42 U.S.C. § 4601 et seq.) and its implementing regulations at 49 CFR Part 24, may be triggered (see www.hud.gov/offices/cpd/library/relocation/index.cfm). Relocation is usually considered to be part of the cost of lead hazard control.

E. How Can Costs Be Minimized?

One approach to minimizing relocation costs is to reduce the time period of temporary relocation. It may be possible to streamline the work so it proceeds quickly, especially if contractors are offered financial incentives to do so. Also, in some circumstances, it may be possible to stage the work, as discussed above, so residents can return before nonhazardous renovation is finished.

Another approach is to minimize specific relocation costs by taking competitive bids or negotiating favorable rates for rental units for relocation, and costs of packing, moving, and storage. Prices should be based on actual expenses, however, not on a per-dwelling-unit rate.

Some local program administrators have found that the most cost-effective approach is to give residents a direct dollar payment to find another place to live temporarily. Beware, however, that if the work takes longer than expected and thus the residents' costs are higher than was planned, people may return to the unit before it is ready. This approach may work in conjunction with temporary relocation to a relative's or friend's home.

Still another approach is to try to move most of the residents only once, rather than both out and back in. This permanent relocation can work with multi-building projects in which residents of the first building are relocated, work is performed in that building, and then residents of the

next building are permanently relocated to the first building, and so on. Variations on this include residents moving from one floor to another, from one wing of a building to another, etc. Some residents may like this; some may not. For projects receiving federal assistance for the housing or the work, such permanent relocation may trigger requirements of the Uniform Relocation Act; see Section IV.D. Open communication with residents about the project and the owner's approach to lead safety may help in addressing concerns about relocation.

Finally, on-site dust testing may save time and money. Methods exist for reliably analyzing wipe samples on-site instead of in a fixed laboratory. These include portable X-ray fluorescence (XRF) analysis and anodic stripping voltammetry (ASV) (EPA, 2002b; Clark, 2002). These methods may provide testing results much more quickly than fixed-laboratory analysis by avoiding transportation of the samples to the laboratory and handling time within the laboratory. This approach may be particularly helpful for multi-family projects, in which a work crew may be working on a unit while the clearance test analysis is being performed on the crew's preceding unit. Thus they may reduce relocation difficulties and facilitate cooperation among all parties.

In States and Tribal areas where EPA is operating the lead risk assessment certification program, dust wipe samples for a clearance examination must be analyzed by a laboratory or testing firm recognized by EPA under the National Lead Laboratory Accreditation Program (NLLAP). In these States or Tribes, an NLLAP laboratory may perform on-site analyses of dust-wipe samples only if specifically accredited and NLLAP-recognized to do so. In States or Tribal lands where the State or Tribe is operating an EPA-authorized lead program, the same requirements generally apply, although there may be some differences (EPA, 2002a). While EPA clearance regulations and program procedures apply only to abatement activities and to renovations in which clearance is being conducted, HUD regulations and many State regulations apply the same procedures to non-abatement activities.

However, any person who is trained and otherwise qualified to operate the XRF instrument (such as licensed in accordance with State regulations on the use of devices with radioactive elements) or conduct the ASV (or other sampling and analytical) method may use one of these methods to conduct *preliminary* dust testing to determine whether a clearance area is clean and ready for the clearance examination, if allowed in the State or Tribal area. A person conducting a preliminary screen does not have to be a technician working for an NLLAP-recognized laboratory. Owners and contractors may wish to use such screening tests to minimize the likelihood of clearance failure. (See Chapter 15, Section VI.A.3, "On-Site Clearance.")

F. Communicating with Residents

Clear and documented communication with residents about the many details of relocation will facilitate a smoothly operating program. Administering organizations should establish policies, procedures, and assigned responsibilities to maximize efficiency of temporary relocation and assure that all program participants are treated in a consistent manner. Among the subjects that should be covered with residents are:

- ◆ The need for and importance of temporarily relocating to protect the health of residents and their children.
- ◆ The fact that residents must stay out of the work areas until permitted to return, and how that permission will be handled.
- ◆ Approximately how long the relocation will last, and how delays in allowing residents to return to their dwellings will be handled.

- ◆ The standards for the relocation unit, who is responsible for identifying it, and how that will be done.
- ◆ Detailed procedures for handling relocation, including such matters as packing, moving, storage, and caring for personal belongings, utilities, mail, security of the temporarily vacant unit, care for pets, and any special transportation needs (such as to and from school).
- ◆ What costs will be paid by the administering organization, limits on certain costs, and method of payment.
- ◆ The residents' responsibility not to damage the relocation unit.

It is recommended that policies and procedures on these matters be put in writing and that residents indicate their agreement by signing such documents. These policies and procedures should be made available to meet the needs of all residents including persons with limited English proficiency.

V. Negative Pressure Zones (“Negative Air” Machines)

In asbestos abatement work and lead-based paint removal work on structural steel, it is common to create worksites that are under negative pressure in comparison to the outside of the containment structure. A negative pressure zone is usually created by blowing air out of the work area through a HEPA filter, while air intake is restricted to a lower flow rate than the exhaust. This process causes any air leakage to move *into* the containment area instead of *out* of the containment area. It also reduces dust fall and worker exposure by removing contaminants from the airstream through constant filtration.

Under OSHA's lead in construction standard, a “competent person” determines the appropriate ventilation controls, considering such factors as the safety of workers, occupancy of adjacent areas, whether exterior windows are available to provide dilution ventilation, or if negative air is more appropriate where scraping of surfaces treated with paint strippers may potentially release both volatile substances and lead simultaneously. The standard says that a competent person is a person capable of identifying existing and predictable lead hazards in the surroundings or working conditions, who has authorization to take prompt corrective measures to eliminate them, and who makes frequent and regular inspections of job sites, materials, and equipment as part of a program to ensure that workers are not exposed to excessive levels of airborne lead. (29 CFR 1926.62, paragraphs (b), (c), (e)(2), and (e)(2)(iii) . For further information about competent persons, see OSHA's Competent Person page, <https://www.osha.gov/SLTC/competentperson/>.)

Due to the different aerodynamics of dust particles from leaded and asbestos fibers, negative pressure zones do not appear to be necessary for most forms of residential paint-disturbing work. Most lead-based paint abatement projects in the public housing program have not found it necessary to use negative air machines. However, there are two specific situations where the use of a negative pressure zone would be appropriate in a residential setting.

The first case involves floor sanding. Even if the lead-based paint or lead-containing varnish has already been removed, leaded dust generation is likely to be quite high due to residual dust in the flooring. Enclosing old flooring with new flooring is the recommended course of action. However, if old flooring must be restored, then negative pressure zones should be established. Up to 10 air changes per hour should be provided and all exhaust air must be passed through a HEPA filter.

If the floor to be sanded has been coated with varnish with low lead levels, negative air may not be necessary. One study has found that tight dust containment of the work area before the work, using engineering controls during sanding and careful cleanup afterwards can reduce worker exposure to dust and facilitate clearance of the worksite. The engineering controls used in this study included using HEPA vacuum exhaust attachments on sanding tools such as edgers and buffers and using drywall dust bags inside the canvas bags of drum floor sanding machines (Wisconsin, 2003).

The second case involves abrasive blasting, which is likely to produce extremely high levels of airborne leaded dust (NIOSH, 1992b) and should not be permitted in housing since other methods are readily available. One report indicated that the exterior sandblasting of a school resulted in 27,100 $\mu\text{g/g}$ of lead in the soil at a nearby residence, and nearly 100,000 $\mu\text{g/g}$ in the soil at the school (Peace, 1983). If for some reason abrasive blasting without local exhaust ventilation is performed on the interior of a dwelling, a full containment structure with HEPA filtration and adequate airflow should be required. Such a containment system would also be necessary if the exterior of a dwelling were blasted, usually resulting in "tenting" an entire building (i.e., erecting a temporary tent-like structure around a building or one face of a building). This setup may also be necessary in cases of major demolition where wet work practices cannot be used to adequately dampen dust.

For nearly all types of paint-disturbing work, windows should be kept closed to prevent dust and chips from leaving the unit. If volatile chemicals will be used, adequate ventilation must be provided, either by opening windows during the use of the chemicals or by supplying air through a HEPA air-handling machine.

References

- California Department of Health Services, 2004. Public Health Institute for California Department of Health Services, Childhood Lead Poisoning Prevention Branch and Environmental Health Laboratory Branch, "Evaluation of Household Vacuum Cleaners in the Removal of Settled Lead Dust from Hard Surface Floors," Final Report to U.S. Department of Housing and Urban Development, 2004.
- Clark, 2002. Clark, C.S., "Development of a Rapid On-Site Method for the Analysis of Dust Wipes Using Field Portable X-Ray Fluorescence," prepared for the U.S. Department of Housing and Urban Development, January 2002.
- CMHC, 1992. Canada Mortgage and Housing Corporation, Saskatchewan Research Council Report, *Effectiveness of Cleanup Techniques for Leaded Paint Dust*, Saskatoon, Saskatchewan, Canada (also see Figley, 1994).
- EPA, 2002a. U.S. Environmental Protection Agency, "Questions & Answers About ETV Reports on Portable Technologies for Measuring Lead in Dust," December 2002. www.epa.gov/lead/pubs/etv.htm
- EPA, 2002b. U.S. Environmental Protection Agency, The Environmental Technology Verification Program (ETV), Verification Statements EPA-VS-SCM-50, 51, 52, 53 and 54. Prepared by Oak Ridge National Laboratory, Oak Ridge, Tennessee, August 2002. www.epa.gov/etv/pubs/02_vs_pal_sa_5000.pdf, www.epa.gov/etv/pubs/02_vs_niton_300.pdf
- Figley, 1994. Figley, D., and Makohon, J., "Effectiveness of Clean-Up Techniques for Leaded Paint Dust," Saskatoon, Saskatchewan: Saskatchewan Research Council, revised report SRC I-4800-38-C-92 to Canada Mortgage and Housing Corporation (originally published in 1992).
- HUD, 2001. U.S. Department of Housing and Urban Development, *Lead Paint Safety: A Field Guide for Painting, Home Maintenance, and Renovation Work*, March 2001 (HUD-1779-LHC). www.hud.gov/offices/lead/training/LBPguide.pdf
- HUD, 2004. U.S. Department of Housing and Urban Development, "Interpretive Guidance on HUD's Lead Safe Housing Rule: The HUD Regulation on Controlling Lead-Based Paint Hazards in Housing Receiving Federal Assistance and Federally Owned Housing Being Sold," Revised June 21, 2004. www.hud.gov/offices/lead/library/enforcement/LSHRGuidance21June04.pdf
- NIOSH, 1992b. National Institute for Occupational Safety and Health, *NIOSH Alert: Request for Assistance in Preventing Lead Poisoning in Construction Workers*, Revised Edition, U.S. Department of Health and Human Services, DHHS (NIOSH) Publication No. 91-116a, April 1992, pp. 1-21.
- NIOSH, 1993a. National Institute for Occupational Safety and Health, Personal communication by Leroy Mickelson on air sampling data for a lead-based paint abatement project on structural steel.
- Peace, 1983. Peace, B. and C.S. Clark, *Removal of Lead-Based Paint From Buildings as a Source of Urban Soil and Dust Contamination*, Annual Report, Center for the Study of the Human Environment, Institute of Environmental Health, University of Cincinnati, May 31, 1983.

Rich, 2002. Rich, David Q., G.G. Rhoads, L. Yiin, J. Zhang, Z. Bai, J.L. Adgate, P.J. Ashley and P.L. Liroy, "Comparison of Home Lead Dust Reduction Techniques on Hard Surfaces: The New Jersey Assessment of Cleaning Techniques Trial," *Environmental Health Perspectives*, 110(9): 889-893, September 2002. <http://www.ncbi.nlm.nih.gov/pmc/articles/PMC1240988/>

Wisconsin, 2003. Wisconsin Division of Public Health, Ikens, Hardwood Floors, J. Schirmer, J. Havlena, and R. Ikens, "Is There Lead in Varnish?," Presentation at Wisconsin Environmental Health Conference, 2003.

Yiin, 2002. Yiin, Lih-Ming, F.F. Rhoads, D.Q. Rich, J. Zhang, Z. Bai, J.L. Adgate, P.J. Ashley and P.J. Liroy, "Comparison of Techniques to Reduce Residential Lead Dust on Carpet and Upholstery: The New Jersey Assessment of Cleaning Techniques Trial," *Environmental Health Perspectives*, 110(12): 1-5, December, 2002. <http://ehp03.niehs.nih.gov/article/fetchArticle.action?articleURI=info%3Adoi%2F10.1289%2Fehp.021101233>



Chapter 9: Worker Protection

HOW TO DO IT	9-3
I. Introduction.....	9-5
II. Background on OSHA Requirements for Residential Lead Hazard Control Work	9-5
III. Signs	9-6
IV. Protective Clothing and Equipment.....	9-7



Intentionally Left Blank

Chapter 9: Worker Protection

How To Do It

- 1. Develop a written compliance plan and designate a competent person to oversee worker protection efforts (usually an industrial hygienist or a certified lead abatement supervisor).** To ensure worker exposure to airborne lead during residential lead-related work does not exceed the permissible exposure limit (PEL) set by the Occupational Safety and Health Administration (OSHA) (50 $\mu\text{g}/\text{m}^3$ averaged over an 8-hour period), develop a written compliance plan and designate a competent person to oversee worker protection efforts (usually an industrial hygienist or a certified lead abatement supervisor). See the OSHA Lead in Construction Standard for complete details (29 CFR 1926.62) at http://www.osha.gov/pls/oshaweb/owadisp.show_document?p_table=STANDARDS&p_id=10641. OSHA's Lead homepage for the construction industry (<http://www.osha.gov/SLTC/lead/construction.html>) provides a range of regulatory and technical resources, such as the informational booklet "Lead in Construction" (OSHA Publication 3142-09R; <http://www.osha.gov/Publications/osh3142.html> and <http://www.osha.gov/Publications/osh3142.pdf>.)
- 2. Conduct an exposure assessment for each job classification in each work area. Monitoring current work is the best means of conducting exposure assessments.** Perform air sampling of work that is representative of the exposure for each employee in the workplace who is exposed to lead. Alternatively, if working conditions are similar to previous jobs by the same employer within 12 months, previously collected exposure data can be used to estimate worker exposures. Finally, objective data (as defined by OSHA) may be used to determine worker lead exposures in some cases. Exposures to airborne leaded dust greater than 30 $\mu\text{g}/\text{m}^3$ (8-hour, time-weighted average) trigger protective requirements. Estimating exposure is not acceptable.
- 3. Use specific worker protection measures.** If lead hazard control will include manual demolition, manual scraping, manual sanding, heat gun use, or use of power tools such as needle guns, then specific worker protection measures are required until an initial exposure assessment is completed. If the initial exposure assessment indicates exposures are less than 30 $\mu\text{g}/\text{m}^3$, the requirements do not legally apply, although exposure to lead should be kept as low as possible at all times.
- 4. Implement engineering, work practice, and administrative controls to bring worker exposure levels below the PEL.** Examples of such controls include the use of wet abatement methods, ventilation and the selection of other work methods that generate little dust.
- 5. Supplement the use of engineering and work practice controls with appropriate respirators and implement a respiratory protection program where needed.** Provide a respirator to any employee who requests one, regardless of the degree of exposure.
- 6. Arrange for a medical exam before work begins for each worker who will be required to wear a respirator. The exam will indicate whether the worker is physically capable of wearing a respirator safely. Conduct fit testing for all workers who will be required to wear respirators.** Workers with beards, scars, or unusual facial shapes may not be able to wear certain kinds of fitted respirators.
- 7. Provide protective clothing and arrange for proper disposal or laundering of work clothing, and proper labeling of containers of contaminated clothing and equipment.**

8. **Provide hand washing facilities, with showers if exposures are over the PEL.**
9. **Implement a medical surveillance program that includes blood lead monitoring under the supervision of a qualified physician pursuant to OSHA regulations.** Initial blood testing for lead exposure is required by OSHA for workers performing certain tasks, such as manual scraping, whenever an exposure determination has not been completed, and for any worker who may be exposed to greater than 30 $\mu\text{g}/\text{m}^3$ of lead on any day.
10. **Ensure that workers are properly trained in the hazards of lead exposure, the location of lead-containing materials, the use of job-specific exposure control methods (such as respirators), the use of hygiene facilities, and the signs and symptoms of lead poisoning.** OSHA requires all lead hazard control workers to be trained and to be given (communicated) specific information on lead hazards for the specific job they are doing. Employers are responsible for training their employees to comply with all of OSHA's construction standards, not just the Lead standard, and this training needs to be work site-specific.
11. **Post lead hazard warning signs around work areas. Also, post an emergency telephone number in case an on-the-job injury occurs.**
12. **Conduct work as specified.**
13. **Conduct worker decontamination before all breaks, before lunch, and at the end of the shift.** Decontamination of workers performing abatement usually consists of:
 - ◆ Cleaning all tools in the work area or a specially designated area in the restricted work area (end of the shift only).
 - ◆ HEPA vacuuming all protective clothing if visibly contaminated with paint chips or dust before entering the decontamination area.
 - ◆ Entering the decontamination area (dirty side).
 - ◆ Removing protective clothing by rolling outward (do not remove respirator yet); removing work shoes and putting in plastic bag. Remove all PPE slowly and from the inside-out to contain any accumulated dust.
 - ◆ Entering shower or washing facility.
 - ◆ Washing hands and then removing respirator.
 - ◆ Taking a shower, if available, using plenty of soap and water; washing hair, hands, fingernails, and face thoroughly (before lunch and at the end of the shift only).
 - ◆ Entering the clean area and putting on street clothing and shoes.
14. **Maintain exposure assessment and medical surveillance records for 30 years.** Notify workers of air sampling and blood lead level results within 5 working days after receiving the results. Provide each worker with a copy of the written medical opinion from their examining physician. Employers must maintain all records of exposure monitoring for 30 years, and all medical records for the duration of each worker's employment plus 30 years.

I. Introduction

The potential for worker exposure to lead (as well as to other hazardous substances, safety hazards, and physical agents) exists during all lead hazard control projects. Due to the recognized adverse health effects of lead, employers should minimize worker lead exposures as much as possible. Employers should refer directly to the OSHA construction lead standard for complete requirements. Links to several OSHA publications are found in Appendix 15.

Where To Get the OSHA Standard and Publications

OSHA standards can be obtained by:

Purchasing individual CFR titles from the U.S. Government Online Bookstore, <http://bookstore.gpo.gov>.

Contacting the OSHA Publications Office at 800-321-OSHA (6742), option 5. Hearing- or speech-challenged individuals may access this number through TTY by calling the toll-free Federal Relay Service at 800-877-8339.

Visiting www.osha.gov (click on Regulations, then, lower down on the Regulations page, click on the Construction tab; for Lead in Construction, scroll to "[1926.62 - Lead](#)"; then click on the main body of the regulation and then each of the appendices).

II. Background on OSHA Requirements for Residential Lead Hazard Control Work

OSHA standards will apply to most forms of residential lead hazard control work. There are several OSHA standards that may apply.

HUD's 1990 Lead-Based Paint: Interim Guidelines for Hazard Identification and Abatement in Public and Indian Housing preceded OSHA's issuing the lead-in construction standard as an interim final rule in 1993. The Guideline's original chapter on worker protection was necessary for HUD abatement projects involving lead-based paint because, at that time, OSHA had no expanded lead standard for worker protection in construction. In fact, OSHA's interim final rule was promulgated in 1993 for the very purpose of filling this gap, and it was issued under the Congressional authority of Title X, Subtitle C, Sections 1031 and 1032, Worker Protection, of the Housing and Community Development Act of 1992 (58 Fed Reg. 26590-01, May 4, 1993).

Accordingly, when HUD last updated these *Guidelines'* chapter on worker protection in 1995, the OSHA standard for lead in construction (which covers interim controls, renovation, repair and painting (RRP), and related work in housing) was still relatively new, so a detailed but summarized presentation of this new OSHA standard was incorporated into Chapter 9 of the *Guidelines*. Since then, however, all of

OSHA's standards and guidance information have been made available to the public on the internet and through downloadable guidance publications and e-tools. OSHA information is also readily available from local OSHA Area Offices and State Consultation programs.

Therefore, to conserve resources and avoid duplication among federal agencies' overlapping requirements with regard to lead hazard control activities, and to ensure improved accuracy of regulatory requirements, Chapter 9 of these *Guidelines* has been substantially revised.

III. Signs

In 2012, OSHA issued a major change in its Hazard Communication Standard (HCS), 29 CFR 1910.1200, modifying the HCS to conform to the United Nations' Globally Harmonized System of Classification and Labelling of Chemicals (GHS). (77 *Federal Register* 17574-17896; March 26, 2012 (<http://www.gpo.gov/fdsys/pkg/FR-2012-03-26/html/2012-4826.htm>; see also <http://www.osha.gov/dsg/hazcom/ghs-final-rule.html> and OSHA's electronic newsletter at <http://www.osha.gov/as/opa/quicktakes/qtGHS03212012.html>) As it is implemented through 2016, this rule will change requirements for material safety data sheets (MSDS) – to be renamed safety data sheets – and requirements for labels and signs.

Several of OSHA's substance-specific standards, including those for lead, have been revised regarding signs and labels. The lead standards contain new requirements, incorporated by the revised Hazard Communication Standard, for mandatory warning signs in each work area where an employee's exposure to lead is above the permissible exposure limit (PEL) of 50 $\mu\text{g}/\text{m}^3$ of airborne lead averaged over an 8-hour period.

The revised signage provisions of the lead standards – see 29 CFR 1910.1025(m)(2) in the general industry standard (which covers maintenance and other non-construction work in housing), and 29 CFR 1926.62(m)(1) in the construction standard – require that:

- ◆ On and after June 1, 2016, the signs for work areas must have the following wording:

- For work covered by the lead in general industry standard:

DANGER
LEAD
MAY DAMAGE FERTILITY OR THE UNBORN CHILD
CAUSES DAMAGE TO THE CENTRAL NERVOUS SYSTEM
DO NOT EAT, DRINK OR SMOKE IN THIS AREA

- For work covered by the lead in construction standard:

DANGER
LEAD WORK AREA
MAY DAMAGE FERTILITY OR THE UNBORN CHILD
CAUSES DAMAGE TO THE CENTRAL NERVOUS SYSTEM
DO NOT EAT, DRINK OR SMOKE IN THIS AREA.

- ◆ Before June 1, 2016, the signage for used for work covered by either the general industry or the construction industry may use either the wording above for that industry, or the wording below:

WARNING
LEAD WORK AREA
POISON
NO SMOKING OR EATING.

Whichever signs are used in a work area, the employer must ensure that they are illuminated and cleaned as necessary so that the legend is readily visible, and that no statement appears on or near them that contradicts or detracts from the meaning of the required signs.

Consultation assistance is available on request to employers who want help establishing and maintaining a safe and healthful workplace. Funded largely by OSHA, the service is provided at no cost to small employers and is delivered by state authorities through professional societies and health consultants.

Paint with lead that is deteriorated or disturbed, even if its lead content is below the current EPA and HUD standards, may still pose a health hazard. As of the publication of the second edition of these *Guidelines*, in response to a petition received by the EPA on August 10, 2009, the EPA and HUD are considering whether to lower the dust hazard standards and/or modify the definition of lead-based paint.

Individual States that have approved plans for OSHA enforcement may adopt their own lead standards for the construction industry, as long as their requirements are at least as stringent as the Federal OSHA standard. Employers will need to ensure that their programs for worker protection meet applicable State requirements. The OSHA standard does not specify the methods for any given type of activity, such as lead-based paint removal. The method of removal is left to the discretion of the employer, and constitutes an important potential engineering control. In some cases, however, the method of abatement or interim control will have already been selected by a risk assessor and/or the property owner based on other considerations.

IV. Protective Clothing and Equipment

The EPA/HUD renovation, repair and painting (RRP) training curriculum recommends the following personal protective equipment for renovation, repair and painting: a painter's hat, disposable coveralls, and R-100, P-100 or disposable N-100 respirator. N-100 is a NIOSH rating for respirators that can be used around leaded dust. "100" means that the respirator has HEPA filtering capability. The "R," "P" and "N" filters refer to the environmental conditions that exist when the respirator is worn. The disposable N-100 respirator is acceptable for small jobs but under other work conditions, OSHA may require another type of respirator. Head covering, such as a painter's hat and shoe covers are recommended as always being appropriate for paint-disturbing work. Eye protection and gloves should be worn if needed, and an eye- and body-wash system must be in place if workers' eyes or body may be injured by caustic materials. In addition, OSHA requires that employers provide and enforce the use of protective clothing whenever employees are exposed to airborne lead above the PEL (irrespective of respirator use) and as interim protection for employees performing tasks listed in OSHA's task-related triggers. Hard-hats, goggles, safety shoes, and other personal protective equipment may also be required by other OSHA standards, depending on the type of work performed. These materials must be generally supplied at

no cost to employees. (See 20 CFR 1926.95(d). Non-specialty safety-toe protective footwear (including steel-toe shoes or steel-toe boots) and non-specialty prescription safety eyewear are among the items for which the employer generally does not have to pay.)

The lead standards contain new requirements, incorporated by the revised Hazard Communication Standard (see Section III, above), for labeling containers of contaminated protective clothing and equipment which is to be cleaned, laundered, or disposed of.

The revised signage provisions of the lead in general industry standard and the lead in construction standard require (see 29 CFR 1910.1025(g)(2)(vii)) and 29 CFR 1926.62(g)(2)(vii), respectively) that labels must have the following wording:

- ◆ On and after on June 1, 2015, the labels for containers of contaminated protective clothing and equipment to be cleaned, laundered, or disposed of must have the following wording:

- For maintenance and other work covered by the lead in general industry standard:

DANGER: CLOTHING AND EQUIPMENT CONTAMINATED WITH LEAD. MAY DAMAGE FERTILITY OR THE UNBORN CHILD. CAUSES DAMAGE TO THE CENTRAL NERVOUS SYSTEM DO NOT EAT, DRINK, OR SMOKE WHEN HANDLING DO NOT REMOVE DUST BY BLOWING OR SHAKING.

- For RRP, interim control and other work covered by the lead in construction standard:

DANGER: CLOTHING AND EQUIPMENT CONTAMINATED WITH LEAD. MAY DAMAGE FERTILITY OR THE UNBORN CHILD. CAUSES DAMAGE TO THE CENTRAL NERVOUS SYSTEM. DO NOT EAT, DRINK OR SMOKE WHEN HANDLING. DO NOT REMOVE DUST BY BLOWING OR SHAKING. DISPOSE OF LEAD CONTAMINATED WASH WATER IN ACCORDANCE WITH APPLICABLE LOCAL, STATE, OR FEDERAL REGULATIONS.

- ◆ Before June 1, 2015, the label used for work covered by either the general industry or the construction industry may use either the wording above for that industry, or the wording below:

CAUTION: CLOTHING CONTAMINATED WITH LEAD. DO NOT REMOVE DUST BY BLOWING OR SHAKING. DISPOSE OF LEAD CONTAMINATED WASH WATER IN ACCORDANCE WITH APPLICABLE LOCAL, STATE, OR FEDERAL REGULATIONS.



Chapter 10: Housing Waste

HOW TO DO IT	10-3
I. Introduction	10-4
II. Recommended Lead-Safe Practices	10-5
A. Low-Lead Content Waste Materials	10-5
B. Architectural Components	10-6
C. Concentrated Lead Waste	10-8
D. Other Regulated Waste	10-9
REFERENCES	10-10
FIGURES	
Figure 10.1 Separate waste into categories during work.	10-4
Figure 10.2 Radiators and trim are examples of intact architectural components that are low-level lead waste.....	10-6
Figure 10.3 Concentrated lead waste.	10-8
Figure 10.4 Paint chips should be double-bagged and seams sealed.....	10-8
Figure 10.5 EPA regulates disposal of hazardous waste.	10-9



Intentionally Left Blank

Chapter 10: Housing Waste

How To Do It

- ◆ **State and local requirements.** Determine whether your State or local health or environmental department has any requirements for management and disposal of waste from work that may disturb surfaces covered with known or presumed lead-based paint; fulfill those requirements.
- ◆ **Waste categories.** Determine what categories of waste will be generated (low-lead waste content materials, architectural components, concentrated lead waste, or other waste) and follow the recommendations in this chapter.
- ◆ **Liquid wastewater.** Dispose of liquid wastewater in the toilet, not in a storm drain or on the ground.
- ◆ **Disposal acceptance of solid waste wrapping.** Determine if the planned state-approved disposal facility accepts solid waste wrapped in plastic or waste from residential projects (e.g., municipal or construction & demolition waste landfills).
- ◆ **Solid waste wrapping.** Wrap solid waste in heavy-duty plastic (6-mil polyethylene or equivalent); seal all seams.
- ◆ **Bag small waste material.** Place small waste material in heavy-duty plastic (single 6-mil or double 4-mil polyethylene or equivalent) bags and securely tape them shut.
- ◆ **Storing and transport of solid waste.** Store solid waste in a designated, secure area separate from the work area and transport it to a State-licensed or permitted solid-waste landfill.

I. Introduction

In August 2000, the U. S. Environmental Protection Agency (EPA) clarified its policy with respect to the status of waste generated by contractors as well as residents from lead-based paint-disturbing activities conducted in households (household waste) (EPA, 2000a). The clarification provided that the household waste exemption in the Resource Conservation and Recovery Act (RCRA; 42 U.S.C. §6901) applies to waste generated by contractors as well as to waste generated by residents. As a result, the household waste exemption applies to all residential paint-disturbing activities, including abatement, interim control, renovation and remodeling of housing. Types of housing included in the household waste exemption are single-family homes, apartment buildings, public housing, and military barracks. Residential lead-based paint waste is waste generated from these activities and includes, but is not limited to, known or presumed lead-based paint debris, chips, dust, and sludges. In 2003 EPA amended its solid waste regulations to codify this policy (EPA, 2003). A summary fact sheet (publication EPA530-F-03-007), available through EPA's website RCRA Online at www.epa.gov/epawaste/nonhaz/municipal/landfill/lbp_fs.pdf, states that:

Construction and demolition (C&D) landfills are allowed to accept residential lead-based paint (LBP) waste for disposal. So long as these landfills do not accept any other household waste, they do not have to change their current operating practices and procedures. Municipal solid waste landfills also may continue to dispose of residential LBP.

This rule applies to residential LBP waste from abatement, rehabilitation, renovation, or remodeling in homes, residences, and other households. "Household" means single and multiple residences, hotels and motels, bunkhouses, ranger stations, crew quarters, campgrounds, picnic grounds, and day-use recreation areas. Individuals and firms who create residential LBP waste, such as contractors and do-it-yourselfers, may dispose of LBP waste from these households at C&D landfills.

Household waste falls into four categories, for the purpose of this chapter:

- ◆ Materials that usually have low lead content, such as personal and mop wash water, protective clothing, and plastic sheeting;
- ◆ Architectural debris, such as painted doors, trim, and windows;
- ◆ Concentrated lead waste content materials, such as paint strippings, lead paint chips, and dust; and
- ◆ Other waste.

On the jobsite, waste should be separated into these categories to the extent possible (see Figure 10.1). While RCRA hazardous waste rules do not apply, HUD and EPA both recommend that the lead-safe practices described in this chapter be followed to reduce the likelihood that household waste will contaminate the environment.

States and local governments may institute hazardous waste handling and disposal requirements applicable to lead activities in housing. Owners and contractors should determine what, if any, State or local regulations apply, particularly what may be disposed of at municipal



FIGURE 10.1 Separate waste into categories during work.

solid waste or construction and demolition landfills. Owners and contractors must comply with these local requirements if they are more stringent than Federal rules.

II. Recommended Lead-Safe Practices

A. Low-Lead Content Waste Materials

This waste category typically exhibits Toxicity Characteristic Leaching Procedure (TCLP) concentrations of leachable lead below 5 ppm. The TCLP is a laboratory procedure designed to predict whether a particular waste is likely to leach chemicals into ground water at dangerous levels (see Unit II.C, below (www.epa.gov/wastes/inforesources/pubs/orientat/romapc.pdf)). This waste category includes filtered personal wash water and mop water, disposable personal protective clothing that has been vacuumed before disposal, plastic sheeting that has been misted and cleaned before disposal, and carpeting. Wash water does not include unfiltered spent stripper solutions, stripper sludges, or any other liquid paint removal products, all of which are simply solid waste.

According to EPA, LBP debris is any component, fixture, or portion of a residence or other building coated wholly or partly with LBP. LBP debris can also be any solid material coated wholly or partly with LBP resulting from a demolition.

Paint chips and dust, leftover paint or paint thinners, sludges, solvents, vacuum filter materials, wash water, sandblasting material, contaminated and decontaminated protective clothing and equipment, and other wastes such as lead-contaminated soil are not considered LBP debris. They remain subject to RCRA requirements.

When properly decontaminated, some of these wastes, such as protective clothing and equipment do not exhibit toxicity characteristics for lead. Some of these wastes are generated in smaller amounts and are homogenous. A hazardous waste determination may easily be made through the use of the Toxicity Characteristic Leachate Procedure (TCLP) or knowledge of that waste. However, a firm is allowed to manage these materials as a solid waste, if:

- ◆ The quantities of hazardous waste (including non-LBP debris waste from LBP activities) the firm generates are less than 100 kg (i.e., approximately one 55-gallon drum/container) per month.
- ◆ The firm qualifies as a conditionally exempt small quantity generator (CESQG) of hazardous waste (including non-LBP debris waste from LBP activities).

Lead-contaminated soil is not considered LBP debris nor is it eligible to be disposed of under the exclusion rule. RCRA requirements must be followed when disposing of lead contaminated soil.

These *Guidelines* recommend that generators follow the following practices for low-level waste content materials:

- ◆ Large waste material should be wrapped in heavy-duty sheeting (6-mil polyethylene or equivalent), and all seams should be sealed with tape during storage and transported to a State-licensed or permitted solid waste disposal facility. (Some disposal facilities do not accept waste wrapped in plastic. In this case, the waste should be covered in plastic during storage and transport only.)
- ◆ Small waste material should be placed in heavy-duty bags (single 6-mil or double 4-mil polyethylene or equivalent). The bags should be securely taped shut with gooseneck closure. OSHA's

disposal requirement is that lead-contaminated protective clothing be placed in a closed container in the change area, per 29 CFR 1926.62(g)(2)(v).

- ◆ The waste should be stored in a designated secure (locked) area. Dumpsters should have lids and be padlocked.
- ◆ Liquid wastewater should be disposed of in the toilet after any local pretreatment steps (e.g., filtering, gravitational separation) have been satisfied. Wastewater should not be poured into storm drains or onto the ground.
- ◆ Wrapping and sealing large waste material in plastic may not be necessary if a covered transport vehicle is used and if plastic is used to line walkways to the vehicle during loading. Wrapping and sealing waste materials in plastic, however, will minimize final cleanup and dust generation from abrasion of loose components coated with lead-based paint.
- ◆ Solid waste should be disposed of only in State-licensed or permitted solid-waste landfills, either municipal or construction and demolition as permitted if available; otherwise it may have to be transported to an approved hazardous waste facility.

B. Architectural Components

This category includes waste defined as intact, discarded architectural components which are sometimes referred to as finish carpentry or painted building components. Such components include, but are not limited to, painted doors, door trim, windows, window trim or sills, baseboards, soffits, fascia, columns, railings, moldings, radiators, walls, and stone or brick (see Figure 10.2). Paint chips that are removed from or fall off these components are not included in this category. Category B does not include lead sheeting.

These *Guidelines* recommend the following procedures for handling architectural components:



FIGURE 10.2 Radiators and trim are examples of intact architectural components that are low-level lead waste.

1. Once components are removed from the contained work area, the cutting or breaking of painted materials or any action that is likely to generate leaded dust should be avoided.
2. Separate glass from windows for recycling. While it is still inside the work area, waste should be wrapped in heavy-duty sheeting (6-mil polyethylene or equivalent) and all seams should be taped shut. Confirm in advance whether the selected disposal facility will accept waste wrapped in plastic. If not, the waste should be covered with plastic during storage and transport only.
3. Store waste in a designated and secure area separate from the work area. If material is stored or handled outdoors, heavy-duty sheeting should be placed underneath and on top of the material to prevent soil contamination. Plywood or other durable material should be placed on top of the plastic to prevent puncture of the plastic by nails or other fasteners.
4. Waste should be transported in covered vehicles to minimize lead dispersal into the environment.
5. Waste should not be disposed of in a solid waste incinerator and it should not be reused or recycled for mulch. Solid waste should be disposed of only in State-licensed or permitted solid-waste landfills, either municipal or construction and demolition as permitted if available; otherwise it may have to be transported to an approved hazardous waste facility

Deconstruction: Deconstruction, an approach to increasing the amount of sustainable construction and decreasing the amount of waste generated from construction projects, has been described as,

“The systematic disassembly of a building, generally in the reverse order of construction, in an economical and safe fashion, for the purposes of preserving materials for their reuse.”
(US Army, 2010)

and

“‘The disassembly of buildings so as to safely and efficiently maximize the reuse and recycling of their materials.’ While cherry-picking the highest-value materials is standard demolition practice, deconstruction aims to increase reuse options by pushing materials salvage beyond the usual windows, doors and light fixtures to include flooring, siding, roofing and framing. In some cases, deconstruction can yield items that are no longer commercially available, such as the old-growth Douglas fir and redwood lumber.” (EPA, 2000b)

Lead-based paint’s “presence can affect the cost effectiveness of structural and non-structural deconstruction projects, because it limits the amount of lumber that can be reused or resold, increases worker safety expenses, and often results in higher costs for LBP removal procedures.” (EPA, 2008) With strong regulations limiting the installation or other reuse of LBP-coated materials supporting the goal of minimizing the potential for subsequent lead exposure by building occupants, materials coated with LBP should not be reused directly. As EPA further notes, the feasibility of deconstructing a building containing materials coated with lead-based paint is very project specific. For example, LBP may be present on just a few building components, such that the small amount of LBP-coated materials would not meaningfully affect project costs, and the best option may be to dispose of the LBP wood. Where a large amount of LBP-coated materials is present, removing the lead-based paint may be feasible; obtaining a significant amount of valuable wood from a large-scale project may defray costs of paint removal. For example,

some species of dimensional lumber, such as oak, southern yellow or other pines, American chestnut, and Douglas fir, can be quite valuable, and may justify paint removal for deconstruction. Similarly, a wood's value is also determined by the original grade, the extent of damage from such things as nail holes and decay, and the size of the lumber. For instance, industry professionals prefer salvaged lumber that is at least 6-feet long with at least 2- by 4-inch dimensions (USDA, 2005). It must be stressed that if a project manager does decide to cut, grind, sand or otherwise manipulate LBP-coated materials, proper safety and health techniques, including containment of the dust, must be utilized to ensure the safety of project workers and subsequent building occupants; see Chapter 9 of these *Guidelines*.

C. Concentrated Lead Waste

This category of waste includes paint strippings, lead paint chips and dust, and vacuum debris and filters. Such waste must be tested by an analytical laboratory and classified as either hazardous or non-hazardous. One EPA test method that is used is the Toxicity Characteristic Leaching Protocol (TCLP), which simulates leaching in a landfill in the laboratory by adding acid to the sample and mixing it for 24 hours before analyzing the liquid for heavy metals. Non-residential waste tested in accordance with the TCLP that it is likely to leach lead above 5 ppm is defined as toxic and must be labeled as hazardous waste category D008 (lead). Then appropriate transport and disposal is required (EPA, 2004) (see Figures 10.3 and 10.4).

These *Guidelines* recommend the following procedures for handling of residential waste:

- ◆ Wrap in plastic with seams sealed shut (if disposal facility allows) or place in heavy-duty bags (single 6-mil or double 4-mil polyethylene or equivalent).
- ◆ Cover during transport.
- ◆ Prohibit from being treated at a solid waste incinerator.
- ◆ Dispose only in a State-permitted or licensed solid waste landfill, if available; otherwise it must be transported to an approved hazardous waste facility.

D. Other Regulated Waste

In some cases, TCLP leachate lead levels of soil that is being removed from the site may exceed 5 parts per million, which EPA otherwise categorizes as hazardous waste (see Figure 10.5). RCRA regulates the proper disposal of toxic wastes, including residential soil that is significantly



FIGURE 10.3 Concentrated lead waste.



FIGURE 10.4 Paint chips should be double-bagged and seams sealed.



FIGURE 10.5 EPA regulates disposal of hazardous waste.

contaminated with lead. An EPA summary of RCRA is at www.epa.gov/lawsregs/laws/rcra.html; links to RCRA regulations in general are at www.epa.gov/epawaste/laws-regs/. Links to information on waste regulation under RCRA is provided at the "Wastes - Information Resources" page, www.epa.gov/wastes/inforesources/; a detailed introduction to RCRA is the "RCRA Orientation Manual 2008: Resource Conservation and Recovery Act," at <http://www.epa.gov/wastes/inforesources/pubs/orientat/index.htm>. EPA can authorize a State to have the primary responsibility of implementing RCRA hazardous waste program or a more-stringent program. As of the publication of these *Guidelines*, all 50 states, the District of Columbia, and Guam are authorized to implement the base, or initial, RCRA program, and many also to implement subsequently promulgated parts of the RCRA program. To help the public find state programs, EPA has included both a map and an alphabetically linked list of states and US territories web sites at www.epa.gov/epawaste/laws-regs/state/stats/stats_safrn.htm. EPA also has a site dedicated to reducing, reusing and recycling construction and demolition debris at <http://www.epa.gov/osw/consERVE/imr/cdm/index.htm>.

References

EPA, 2000a. U.S. Environmental Protection Agency, "Regulatory Status of Waste Generated by Contractors and Residents from Lead-Based Paint Activities Conducted in Households," Memorandum signed July 31, 2000. See www.epa.gov/lead/pubs/fslbp.htm. Accessed 7/31/2012; this site may be moved or deleted later.

EPA, 2000b. U.S. Environmental Protection Agency, Building Deconstruction and Design for Reuse (FY2002 OSWER Innovation Pilot Results Fact Sheet), www.epa.gov/oswer/docs/iwg/building_decon_reuse.pdf. Accessed 7/31/2012; this site may be moved or deleted later.

EPA, 2003. U.S. Environmental Protection Agency, Criteria for Classification of Solid Waste Disposal Facilities and Practices and Criteria for Municipal Solid Waste Landfills: Disposal of Residential Lead-Based Paint Waste, Final Rule, 68 Federal Register 36487-36495: June 18, 2003. Accessed 7/31/2012 through <http://www.fdsys.gov>; this site may be moved or deleted later.

EPA, 2004. U.S. Environmental Protection Agency, RCRA in Focus: Construction, Demolition, and Renovation, EPA-530-K-04-005, available at <http://www.epa.gov/wastes/inforesources/pubs/infocus/rif-cd.pdf>. Accessed 7/31/2012; this site may be moved or deleted later.

EPA, 2008. U.S. Environmental Protection Agency, Lifecycle Construction Resource Guide. http://www.epa.gov/oswer/iwg/pilots/docs/2008_lifecycle_construction_resource_guide.pdf. Accessed 7/31/2012; this site may be moved or deleted later.

US Army, 2010. U.S. Army Corps of Engineers, Construction Waste Management, Research and Development Center / Construction Engineering Research Laboratory (Tom Napier). Published in National Institute of Building Sciences, Whole Building Design Guide. www.wbdg.org/resources/cwmgmt.php. Accessed 7/31/2012; this site may be moved or deleted later.

USDA, 2005. U.S. Dept. of Agriculture, Directory of Wood-Framed Building Deconstruction and Reused Building Materials Companies, 2004. Forest Products Laboratory (Robert H. Falk, G. Bradley Guy). General Technical Report FPL-GTR-150. http://www.fpl.fs.fed.us/documnts/fplgtr/fpl_gtr150.pdf. Accessed 7/31/2012; this site may be moved or deleted later.

Chapter 11: Interim Controls

THE BASIC STEPS COMMON TO MOST JOBS – HOW TO DO IT	11-5
I. INTRODUCTION.....	11-7
A. When Interim Controls Are Appropriate and When They Are Not.....	11-8
B. The Standard Treatments Option.....	11-8
C. Combinations of Interim Controls and Abatement of Certain Hazards.....	11-10
D. Preventive Measures That Can Be Performed by Residents	11-10
II. Basic Practices and Standards Applicable to Interim Control Jobs	11-10
A. Preparing a Lead Hazard Control Plan for Multi-family Housing	11-10
B. Qualifications of Persons and Firms Performing Interim Controls.....	11-12
C. Small Amounts of Paint Disturbance.....	11-13
D. Lead-Safe Work Practices	11-14
E. Pre-Renovation Education.....	11-16
F. Resident Protection and Worksite Preparation During Control Activities	11-17
G. Worker Protection	11-18
H. Waste Handling.....	11-18
I. Cleanup	11-18
J. Clearance.....	11-18
K. Notification to Occupants of the Results of Hazard Evaluation and Control.....	11-19
L. Ongoing Lead-Safe Maintenance	11-20
M. Reevaluation	11-20
N. Documentation	11-20
III. Paint Stabilization	11-22
How To Do It	11-22
A. Typical Lead Containing Coatings and Their Failures	11-23
1. Moisture.....	11-23
2. Aging	11-23
3. Mechanical Damage	11-23
4. Chemical Incompatibility	11-25
5. Poor Surface Preparation.....	11-25
B. Substrate Condition and Repairs.....	11-25
1. Building Envelope Leaks.....	11-25
2. Interior Repairs and Water.....	11-26
3. Water Vapor Management	11-27
4. Substrate Repairs.....	11-27
C. General Paint Application Guidelines	11-28
1. Appropriate Conditions.....	11-28
2. When Paint Stabilization Will Not Last Very Long.....	11-28

3. General Recommendations for Applying Paint.....	11-28
D. Worksite Preparation	11-29
E. Surface Preparation	11-29
1. Paint Removal Practices.....	11-30
2. Cleaning Surfaces of Dust and Chips.	11-31
F. Priming	11-31
1. Oil- and Alkyd-Based Primers.....	11-31
2. Waterborne Primers.....	11-32
G. Top-coats	11-32
H. Cleaning and Clearance or Cleaning Verification	11-33
I. Maintenance.....	11-33
IV. Treatment of Friction, Impact, and Chewable Surfaces	11-34
How To Do It	11-34
A. Definition of Terms	11-35
1. Friction Surfaces	11-35
2. Impact Surfaces	11-36
3. Chewable Surfaces	11-36
B. Lead Hazard Control Measures	11-37
1. Window Systems.....	11-37
2. Door Systems.....	11-40
3. Stair Systems.....	11-41
4. Chewable Surfaces	11-41
5. Baseboards and Outside Wall Corners.....	11-42
6. Drawers and Cabinets	11-43
7. Porches, Decks, and Interior Floors.....	11-43
V. Dust Removal and Control	11-44
How To Do It	11-44
A. Introduction.....	11-45
1. Sources and Locations of Leaded Dust	11-46
2. Removing Leaded Dust From a Dwelling	11-47
3. Creating Cleanable Surfaces and Determining Whether Dust Removal Alone Is Adequate	11-48
4. Planning and Preparations.....	11-49
5. Responsibilities of Owners	11-50
6. Responsibilities of Contractors.....	11-50
B. Methods of Dust Removal	11-51
1. Cleaning Hard Surfaces	11-51
2. Removal or Cleaning of Carpets.....	11-54
3. Cleaning Upholstered Furniture	11-58

4. Forced Air Systems and Drop Ceilings.....	11-58
5. Resident Protection	11-60
C. Follow-up to Dust Removal.....	11-60
VI. Soil Interim Controls.....	11-61
How To Do It	11-61
A. Definition of Soil Lead Hazards	11-62
B. Temporary and Permanent Soil Treatments.....	11-62
C. Types of Interim Control Measures for Soil	11-62
1. Soil Alteration	11-63
2. Soil Surface Cover.....	11-63
3. Raised Beds and Other Landscaping Options.....	11-64
4. Land Use Controls	11-65
5. Reduction of Soil Tracking into Dwellings	11-67
6. Drainage and Dust Controls	11-67
D. Making a Plan.....	11-67
E. Guidance on Specifications for Interim Controls of Soil Lead Hazards	11-68
F. Monitoring and Maintaining Soil Interim Controls.....	11-68
REFERENCES.....	11-69
FIGURES	
Figure 11.1 Moisture-Related Causes of Paint Failure	11-24
Figure 11.2 HEPA Vacuum Sanders	11-30
Figure 11.3 Window before and after friction treatment.....	11-35
Figure 11.4 Examples of impact and chewable surfaces.....	11-36
Figure 11.5 Prepare the worksite and pre-clean the window	11-37
Figure 11.6 Remove parting bead.	11-37
Figure 11.7 Remove the bottom sash, sash weights and stops	11-38
Figure 11.8 Remove sash controls/weights.....	11-38
Figure 11.9 Window after removal of sash weights	11-38
Figure 11.10 Rebuild damaged sash with filler or putty.....	11-38
Figure 11.11 Wet plane edges of sash to fit new jamb liners	11-38
Figure 11.12 Vacuum window again.....	11-38
Figure 11.13 Fit sashes into jamb liners	11-39
Figure 11.14 Reinstall sash into jamb	11-39
Figure 11.15 Stabilizing paint on doors: Wet planning and wet sanding	11-40
Figure 11.16 Before and after stair treatments	11-41
Figure 11.17 Covering Stairs with Tread Guards.....	11-42

Figure 11.18 Shoe Molding Is an Acceptable Impact Surface Treatment for Baseboards... 11-42

Figure 11.19 Corner Bead Coverings Can Be Used on Outside Corners of Walls..... 11-42

Figure 11.20 Turning a Window Sill and Trough Into a Smooth and Cleanable Surface..... 11-48

Figure 11.21 How to Use a HEPA Vacuum 11-52

Figure 11.22 Changing HEPA vacuum filter 11-54

Figure 11.23 Carpet with debris and after cleaning..... 11-58

Figure 11.24 Air vent before and after cleaning 11-59

Figure 11.25 Clean Air Vent Registers..... 11-59

Figure 11.26 Walk-Off Mats..... 11-60

Figure 11.27 Thorny Bushes as a Land Use Control 11-65

Figure 11.28 Using Fencing as an Interim Control 11-65

TABLES

Table 11.1 Finish Coats for Paint Stabilization..... 11-32

Table 11.2 Sticky Tape Technique for Removing Loose Paint on Impact Surfaces for Owner/ Occupants or Residents 11-43

Table 11.3 Potential Sources of Lead-Containing House Dust..... 11-46

Table 11.4 Major Dust Reservoirs and Potential Dust Traps..... 11-47

Table 11.5 Rug Cleaning Steps and Approximate Time Per 10 Square Feet..... 11-57

Table 11.6 Grasses and Their Appropriate Applications 11-66

Chapter 11: Interim Controls

The Basic Steps Common to Most Jobs – How to Do It

- 1. Decide on hazard control methods to be used and prepare specifications.** For building components, determine which lead-based paint hazards reported by a risk assessor or presumed to be present will be addressed with interim controls (dust removal, paint stabilization, and/or control of friction/abrasion points) and which will be permanently abated (component replacement, paint removal, enclosure, or encapsulation). (Note that, if renovation or rehabilitation is the intention of the work, some or all of the component replacement may not be abatement, but may be conducted as an interim control. See Appendix 6, regarding the applicable regulations.) For soil lead hazards, decide which interim control or abatement measure is appropriate for the climate, the planned use of the area, and how frequently children under age 6 will use the area. The amount of detail provided in specifications should be commensurate with the size of the job. The specifications should state how any abatement activities and other construction work (e.g., weatherization) will relate to the interim control work. It may be efficient to combine contracts or work orders for interim controls and those for abatement activities in many cases.
- 2. Prepare a lead hazard control plan, especially for multi-family housing.** For a multi-family property in which work must be done in more than 10 dwelling units, the owner, together with a certified risk assessor, planner, or other designer, should develop a site-specific lead hazard control plan. The owner of a smaller property may wish to have a lead hazard control plan developed for that property, as well. The plan should be based on the lead-based paint hazards identified, the feasibility of the control measures, occupancy by young children, and financing. (See Section II.A of this chapter.)
- 3. Determine that the contractor and supervisor are certified to do the work in a lead-safe manner.** Select a contractor that is certified as a renovation firm by the U.S. Environmental Protection Agency (EPA) or the State or Tribe to do renovation work in target housing in the State or Tribal area where the property is located. A property owner or manager using staff to conduct the work must obtain certification as a renovation firm, and ensure that the project obtains certification as a renovator. Workers must be trained and properly supervised to assure that lead-safe work practices are followed on the job. (See Section II.B.) Note that the requirement to use a certified renovation firm and certified renovator do not apply if the work in target housing is minor repair and maintenance work, as defined by EPA; if the work is in HUD-assisted target housing, the requirement does not apply if the work is at or below HUD's *de minimis* threshold (see Section II.C, below).
- 4. Provide pre-renovation education to occupants.** EPA requires contractors to notify residents of the affected dwelling(s) of the work, describing its scope, locations when it is expected to begin and end, and provide residents with the "Renovate Right" pamphlet no more than 60 days before work begins. If the scope, locations or schedule change, provide notification of the change before work beyond that originally described is begun. (See Section II.E, and Appendix 6 for more detail.) Determine if State, Tribal and/or local pre-renovation education requirements apply. (Make a similar determination for other items discussed throughout this Chapter.)
- 5. Prepare the worksite and protect the occupants.** Determine the appropriate worksite preparation and occupant protection measures for the job, based on guidance in Chapter 8. Inform the residents and install the barriers and containment.
- 6. Perform the work.** Perform the work as planned, in accordance with guidance in Sections III, IV, V, and VI.

7. **Handle and dispose of waste correctly.** Wrap or bag all solid waste tightly, store it in a secure area, and dispose of it properly. Liquid waste can usually be disposed of in a sanitary sewer system, but not a storm sewer. Comply with state and local requirements. (See Chapter 10 for further guidance.)
8. **Conduct daily cleanups.** Clean up the work area and pathways used by workers at the end of each work day (or work shift, if work is being done in multiple shifts). (See Chapter 14, sections IV.B and C.)
9. **Conduct final cleanup.** The final cleanup should be started no sooner than 1 hour after completion of the work, to allow time for lead particles to settle. If the area to be cleared may have had high lead levels before the work and/or has rough horizontal surfaces that may make clearance difficult, consider using a pre-clearance screen to be sure the space is ready for clearance or cleaning verification. If the project fails the pre-clearance screen, conduct another final cleanup and pre-clearance screen. If the project fails the second pre-clearance screen, either: (1) complete interim controls and/or re-clean; or (2) conduct the clearance examination or cleaning verification. (For further guidance on cleanup, see Section II.I of this chapter and Chapter 14.)
10. **Clearance.** Have an independent, certified risk assessor, lead-based paint inspector, or sampling technician conduct a clearance examination no sooner than 1 hour after final cleanup to let dust settle (see Chapter 15). If clearance is not achieved, complete interim controls and/or re-clean. Following a successful clearance examination, the property owner should receive documentation to that effect.
 - ◆ Note that the EPA allows certain work areas in housing not covered by HUD's Lead Safe Housing Rule (24 CFR 35, subparts B–R) to be reoccupied after a visual inspection for residual dust, debris and residue, and a "cleaning verification," which is a visual comparison of wet disposable cleaning cloths that have been wiped over windowsills, uncarpeted floors, or countertops with a reference cleaning verification card, as a means of determining whether post-renovation cleaning has been properly completed. (See Appendix 6 for more detail.)
 - ◆ Note that the EPA's cleaning verification requirement does not apply if the work in target housing is minor repair and maintenance work; if the work is in federally-assisted target housing, HUD's clearance requirement does not apply if the work is at or below HUD's *de minimis* threshold (see Section II.C, below).
11. **Notification of residents.** The property owner or manager should notify residents of what lead-based paint hazards were controlled and how, and the results of the clearance examination. While residents do not have to be notified for interim control or other renovation work in target housing that is not federally-assisted – only the contractor's client has to be informed of the results of the cleaning verification and other results of the work – HUD recommends that the residents be notified whether or not the housing is assisted.
12. **Perform ongoing lead-safe maintenance.** The owner should conduct ongoing maintenance and monitoring of interim controls to ensure that they remain in place. (See Chapter 6 for detailed guidance on lead-safe maintenance.) If reevaluation is required by regulation or the hazard control plan for the property, reevaluations by a certified risk assessor should be completed at two-year intervals. (See Section II.M of this chapter and Section VII of Chapter 5.)
13. **Document the work and retain records.** The owner should assure that the work and the clearance examination (or cleaning verification) have been documented, and should maintain records of all lead hazard control, clearance, reevaluation, maintenance and monitoring activities. (See Appendix 6 for record retention requirements.) The owner must turn over all lead-related records the owner has to any new owner before sale of the property as part lead disclosure. (See Section II.N for a list of documents.) The owner must also make disclosure of lead-related documents to tenants before they become obligated under new leases or revised leases (see Appendix 6).

I. Introduction

Interim controls are intended to make dwellings lead-safe by temporarily controlling lead-based paint hazards. Abatement is intended to permanently control lead-based paint hazards. See Chapter 12 for a detailed discussion of the difference between abatement and interim controls. In Title X of the Housing and Community Development Act of 1992, interim controls are defined as

“... a set of measures designed to reduce temporarily human exposure or likely exposure to lead-based paint hazards, including specialized cleaning, repairs, maintenance, painting, temporary containment, ongoing monitoring of lead-based paint hazards or potential hazards and the establishment and operation of management and resident education programs.”

Interim control measures are fully effective only as long as they are carefully monitored, maintained, and, in some cases, professionally reevaluated. If interim controls are properly maintained, they can be effective indefinitely. As long as surfaces are covered with lead-based paint, however, they constitute potential hazards.

Interim lead hazard control measures include:

- ◆ Repairing all rotted or defective substrates that lead to rapid paint deterioration. (Note that repairing defective building systems that are causing substrate damage may be a prerequisite for effective interim control but is outside the scope of interim control per se).
- ◆ Stabilizing all deteriorated lead-based paint surfaces. Paint stabilization entails removing deteriorating paint, preparing the substrate for repainting, and repainting (see Section III).
- ◆ Making floors and interior window sills and window troughs smooth and cleanable.
- ◆ Eliminating friction surfaces with lead-based paint on windows, doors, stair treads, and floors, when they are generating dust lead hazards (see Section IV).
- ◆ Repairing doors and other building components causing impact damage on painted surfaces, if the paint is lead-based paint (see Section IV).
- ◆ Treating protruding, chewable surfaces, such as interior window sills, where lead-based paint may be present and there is either visual or reported evidence that children are mouthing or chewing them (see Section IV).
- ◆ Dust removal and control – i.e., cleaning surfaces to reduce levels of dust containing lead to acceptable levels, including cleaning carpets, if they are contaminated (see Section V).
- ◆ Covering (with planting, mulch, gravel, or other means) or eliminating access to all bare soil containing excessive levels of lead (see Section VI).

Activities that are required by HUD or EPA are identified in this chapter as being “required” or as actions that “must” be done. Activities that are not required by HUD but are recommended by these *Guidelines* are identified as being “recommended” or as actions that “should” be done. Activities that may be done at the discretion of the owner or manager are identified as “optional.”

A. When Interim Controls Are Appropriate and When They Are Not

It is easiest and most appropriate to use interim controls when substrates are structurally sound and lead exposure comes primarily from deteriorating paint and excessive levels of lead in household dust and/or soil. Interim controls are also appropriate if the housing unit is slated for demolition or renovation within a few years and the investment in more costly abatement is not merited. In many cases resources will not be available to finance abatement, making interim controls the only feasible approach. (Abatement measures are either literally permanent, in the case of component removal, or are considered by Title X as being permanent because they last for at least 20 years, in the case of enclosure or encapsulation. These latter measures are “permanent” if they are maintained by establishing and implementing an ongoing lead-safe maintenance plan for at least 20 years, and, in the case of encapsulants, the products have a 20-year or longer warranty subject to the implementation of the maintenance plan. Enclosure or encapsulation without such an expected longevity and maintenance plan may be conducted as interim control measures.)

Interim controls are unlikely to be effective if the building has substantial structural defects or if interior or exterior walls, or major components, such as windows and porches, are seriously deteriorated or subject to excessive moisture. Paint cannot be effectively stabilized unless substrates are dry, structurally sound, and waterproof. Other interim control measures, such as window repair, will also not be very effective if structural problems are likely to result in rapid treatment failure. Any structural problems should be repaired before interim controls are implemented. If these problems cannot be repaired, more frequent monitoring will be necessary to identify possible early failures and more frequent hazard controls will probably be needed.

Abatement may be required by federal, state, or local regulations in certain situations; in such situations, interim controls are precluded. For example, HUD requires that public housing authorities abate all lead-based paint in dwelling units undergoing comprehensive modernization. HUD regulations also require that all lead-based paint hazards on a property be abated in the course of rehabilitation projects that use more than \$25,000 of Federal rehabilitation funds per dwelling unit (24 CFR Part 35, Subpart J; see also HUD’s Interpretive Guidance on its Lead Safe Housing Rule, particularly items J3 and J3a, at its http://portal.hud.gov/hudportal/documents/huddoc?id=DOC_25476.pdf). Some State and local governments have enacted laws and regulations requiring that certain lead-based paint hazards be abated.

Energy-efficient products (such as energy-efficient doors and windows) should be considered whenever building components are replaced. A source of information on energy efficient products is www.energystar.gov (click on the “Find ENERGY STAR Products” or similar hotlink).

B. The Standard Treatments Option

Before controlling lead-based paint hazards, it is necessary to know where they are. This means that a risk assessment (as described in Chapter 5) must be conducted first. However, unless prohibited by State or local law, a property owner may elect to bypass the risk assessment and proceed directly to a set of maintenance and repair activities that will eliminate, at least temporarily, any lead-based paint hazard that might be present. This option is called “standard treatments.” HUD regulations permit standard treatments as an option where interim controls are required in pre-1978 housing receiving Federal assistance, and pre-1978 housing being sold by the Federal government (24 CFR 35.120(a)).

Standard treatments consist of the following activities:

- ◆ Paint stabilization. All deteriorated paint on exterior and interior surfaces should be stabilized, following guidance in Section III of this chapter.
- ◆ Making surfaces smooth and cleanable. All horizontal surfaces, such as floors, stairs, interior window sills and window troughs, that are rough, pitted or porous, should be made smooth and easily cleanable. Minor surface damage may be correctable by spackling and recoating. Otherwise it may be necessary to cover or coat the surface with a material such as metal coil stock, plastic, polyurethane, sheet vinyl, or linoleum.
- ◆ Correcting dust-generating conditions. Conditions causing friction or impact on painted surfaces should be corrected, following guidance in Section IV of this chapter.
- ◆ Treating bare soil. Bare soil should be treated in accordance with guidance in Section VI of this chapter.
- ◆ Safe work practices and worker qualifications. All standard treatments should incorporate safe work practices as described in Section II.D of this chapter. Persons performing standard treatments should have the same training and/or supervision as those performing interim controls, as described in Section II.B.
- ◆ Clearance. A clearance examination should be performed in accordance with Chapter 15 after finishing standard treatments that are larger than HUD's *de minimis* threshold before they are concluded. In housing not receiving federal assistance, EPA requires interim control projects larger than its minor repair and maintenance threshold to have a "cleaning verification" step before they are concluded.
- ◆ Other recommended practices. All other recommended practices applicable to interim controls, as described in Section II, also apply to standard treatments. Also, although HUD regulations do not require treatment of chewable surfaces under the standard treatments option, these *Guidelines* recommend that owners or managers consider covering any protruding painted surfaces with teeth marks if young children under age 6 reside in the unit or frequent the common area. (See Section IV.)

In planning and carrying out standard treatments, owners and contractors should presume that all paint is lead-based paint and all bare soil contains soil lead hazards, unless a certified risk assessor or lead-based paint inspector has determined otherwise. The disadvantage of standard treatments is that unnecessary lead hazard control work may be done. The possible advantage is that the owner may save money by foregoing a risk assessment and can simplify the work of the property manager and the maintenance crew by training and tasking a crew to efficiently perform a routine set of work activities that will be lead-safe whether or not lead-based paint is actually present. Standard treatment options may be appropriate for a well-maintained multi-family property with its own appropriately trained maintenance staff.

When there is a substantial likelihood that some treatable surfaces do not contain lead-based paint, owners who hire risk assessors will usually save money overall because the risk assessment will focus the owners' efforts on confirmed hazards, and avoid unnecessary lead hazard control costs for work on building components that are not coated with lead-based paint.

Some state and local laws prescribe certain treatments in order for the housing unit to qualify as lead-safe. Insurance companies and lenders may also prescribe certain treatments if a property is to qualify for insurance coverage or a loan. In all cases, the property owner should ensure that, at a minimum, the required lead hazard control measures are carried out.

C. Combinations of Interim Controls and Abatement of Certain Hazards

In many dwellings, owners will choose a combination of interim controls *and* abatement. This decision is best made in consultation with a certified risk assessor. For example, it is possible to stabilize deteriorated lead-based paint and remove excess levels of leaded dust (interim controls), and at the same time enclose some lead-based painted surfaces, replace some lead-based painted components, or remove lead-based paint from some surfaces (abatement). Such combinations of interim control and abatement treatments will often be the most cost-effective response to a property owner's lead hazard problem, particularly if carried out when the dwelling unit is vacant.

D. Preventive Measures That Can Be Performed by Residents

There are also a number of preventive measures to minimize the likelihood or severity of lead-based paint hazards that owner-occupants or residents of rental dwellings can carry out. Owners of rental properties should provide residents with educational materials furnished by State or local agencies or lead poisoning prevention organizations that include the following basic information:

- ◆ Children's toys should not be placed beneath windows or near surfaces subject to frequent friction or impact or near deteriorated paint surfaces.
- ◆ If there is a sudden loosening of paint material through friction, impact, or any other reason, occupants should use the sticky tape method to remove loose paint described in Table 11.2.
- ◆ Porch decks, interior floors, and other horizontal surfaces should be wet mopped at least twice a month.
- ◆ A door mat should be placed inside doors with direct access to the outdoors, and thoroughly vacuumed weekly.
- ◆ Instances of deteriorating paint should be reported to management as soon as they are discovered.

II. Basic Practices and Standards Applicable to Interim Control Jobs

This section describes the basic practices and standards that are common to most interim control activities. Later sections of the chapter describe work practices that are specific to particular types of jobs, such as paint stabilization, treatment of friction surfaces, dust removal, and soil lead hazard controls.

A. Preparing a Lead Hazard Control Plan for Multi-family Housing

Conducting interim controls of lead-based paint hazards in multi-family housing presents issues not generally found in single-family housing. In most occupied multi-family developments, it is not feasible, financially or logistically, to carry out hazard control activity in all dwelling units at once. In properties with a relatively small number of dwelling units, it may be possible to proceed unit by

unit and complete the hazard control work quickly. In larger properties, however, decisions must be made as to the order of work in dwelling units and common areas, and perhaps, in rooms or components within dwelling units and common areas. Even when an entire building is vacant and undergoing renovation, hazard control elements of the work must be identified and scheduled. Therefore, it is usually advisable that there be a lead hazard control plan for properties with more than 10 units.

Owners should have an independent certified risk assessor prepare a lead hazard control plan to address lead-based paint hazards identified by the risk assessment. If no risk assessment has been conducted, the specific hazards that are presumed to be present should be addressed by using standard treatments. The plan should prioritize and schedule control measures and any additional hazard evaluations so that available resources are targeted for maximum benefit. Lead hazard control planners or designers may also be helpful in preparing such a plan. In developing the plan, the risk assessor should consult with the property owner to gain insights about the property to determine which strategies will be most appropriate. The goal of this consultation is to combine in the plan the risk assessor's knowledge of lead-based paint hazards with the property owner/manager's knowledge of the particular property – its maintenance history, persistent problems, occupancy profile, capital improvement program, etc.

An owner of a building in good condition may find it more efficient to omit the risk assessment, presume all paint is lead-based paint, and proceed directly to standard treatments. Standard treatments can be performed on a routine basis, at the time of turnover of dwelling units, and during periodic maintenance of units, common areas, and grounds.

In developing a lead hazard control plan, it is reasonable to consider treating units occupied by children under age 6 or by women who have informed the property owner or manager that they are pregnant first. Common play areas, child care centers, or dwelling units serving as child care centers are also candidates for early treatment. It is reasonable to consider the fact that it is less expensive to conduct hazard controls effectively and safely in vacant units than in occupied units.

Thus, it may be appropriate to postpone some hazard control treatments until unit turnover. In order to more quickly and cost effectively reduce childhood exposure to lead in the environment, it is reasonable to consider the relocation of families with young children from housing units with lead-based paint (LBP) hazards to vacant units where any hazards have been controlled.

At a minimum, a lead hazard control plan should include the following elements:

- ◆ A hazard control schedule for all units. Usually units with young children or women who have informed the property owner or manager that they are pregnant should be treated first, followed by other units.
- ◆ A commitment on the part of the owner and manager to ongoing lead-safe monitoring and maintenance as explained in Chapter 6. This should include visual assessments by owner or staff, and control of lead-based paint hazards that are generated during routine maintenance work or normal building aging, what those controls consist of, and how those controls will be implemented.
- ◆ A description of how maintenance workers and other staff will be trained to handle lead-based paint hazards safely and perform lead-safe renovations.

- ◆ Specific measures that will be taken during unit turnover (often paint stabilization, specialized dust removal, the provision of cleanable surfaces on floors, sills, and troughs and some minor building component replacement).
- ◆ A description of who will perform clearance examinations – whether by a certified independent consultant (which is recommended in all situations), or by a designated certified in-house staff (if the work is done by an independent contractor) as allowed under the Lead Safe Housing Rule.
- ◆ A schedule for hazard control actions to be completed in common areas.
- ◆ A schedule for reevaluations by certified risk assessors, if recommended.
- ◆ Designation of an individual, preferably on the staff of the owner or the property manager, who is responsible for issues associated with lead-based paint hazards.

B. Qualifications of Persons and Firms Performing Interim Controls

Interim control activities frequently disturb lead-based paint (LBP) and take place in areas with excessive levels of dust that contains lead. EPA and OSHA have established regulations that cover these activities, as has HUD for these activities conducted in federally-assisted housing.

1. **EPA RRP Rule**, EPA's Renovation, Repair and Painting (RRP) rule covers renovation projects in assisted and unassisted target housing and child-occupied facilities, unless they are smaller than EPA's minor repair and maintenance threshold. The term "renovation" includes repair and painting; interim control projects are "renovations." The RRP Rule requires a firm performing renovation in target housing to be certified as a lead-safe renovation firm, and an individual certified as a lead-safe renovator to provide on-the-job training for workers used on the project, perform or direct workers to follow the RRP rule's work practice standards, be at the job or available when work is being done, and perform the post-renovation cleaning verification (40 CFR 745, subpart E).

A renovation firm must be certified (licensed) by the State or Tribe where the testing is to be done if the State or tribe has an EPA-authorized renovation certification program. The State or Tribe may have qualification requirements for firms and persons performing interim controls that are different than those of the Federal Government. If the State does not have such a program, the renovation firm must be certified by EPA. The list of EPA-authorized States and tribes is at the EPA's RRP web page <http://www.epa.gov/opptintr/lead/pubs/renovation.htm>; the agencies administering their programs are linked from that page. For other States and Tribal areas, EPA administers the renovation certification program; contact information for the EPA Regional Lead Coordinators is at the Where Your Live web page, <http://www.epa.gov/opptintr/lead/pubs/leadoff1.htm>, which can be reached from a link on the RRP web page. A list of certified renovation firms is available on another link from the RRP web page to http://cfpub.epa.gov/flpp/searchrrp_firm.htm. Information on becoming a lead-safe certified firm is at http://www.epa.gov/opptintr/lead/pubs/lscp-renovation_firm.htm.

2. **HUD LSHR**. HUD's Lead Safe Housing Rule (LSHR) requires the workers, as well as the project supervisor, to be trained in HUD-approved lead-safe work practices for work in federally-assisted target housing. This means that the workers and the supervisor must be certified renovators, or, if any of the workers are not certified renovators, the supervisor be a certified lead-based paint abatement supervisor in addition to being a certified renovator. The EPA's

RRP curriculum is HUD-approved for individuals performing interim controls; it meets both HUD interim controls training requirements and EPA's RRP training requirements.

Some States have policies on qualifications for persons performing interim controls that are different than those of the Federal Government. A list of State agencies that operate EPA-authorized programs to regulate lead-based paint activities is at <http://www.epa.gov/lead/pubs/traincert.htm>. The EPA Regional Lead Coordinators oversee the development of lead-poisoning prevention efforts within the Region, including managing the lead certification programs in States which are not authorized to operate their own programs; their contact information is at <http://www.epa.gov/lead/pubs/leadoff1.htm>.

3. **OSHA.** OSHA requires that all potentially exposed workers in the construction industry, which includes most interim control activities, be trained concerning hazards in their workplaces under its rule on Safety Training and Education, 29 CFR 1926.21(b)(2), even if lead exposures are below the action level (see Chapter 9). In addition, OSHA's lead in construction standard, at 29 CFR 1926.62(d)(2)(v)(F), requires hazard communication training on lead for all potentially exposed workers. This provision also requires that employers must provide additional lead-specific training to their workers who are exposed at or above the action level on any single day (also addressed in Chapter 9 and Appendix 6).
4. **Structured On-the-Job Training.** The EPA's Renovation, Repair and Painting (RRP) Rule allows for the certified renovator overseeing a renovation project to conduct on-the-job training (OJT) of workers instead of their becoming certified renovators (40 CFR 745.225(d)(6)(ix). EPA, in the RRP Rule's preamble (73 *Federal Register* 21691-21769, April 22, 2008, at 21721) discussed structured OJT (SOJT) and stated that it had decided not to establish an SOJT program as a requirement for training renovation project workers who are not themselves certified renovators.

These *Guidelines* encourage renovation firms to consider training uncertified workers using SOJT approach, as way to produce consistent, accurate, and comprehensive training outcomes. See Appendix 5.1 for information and references on SOJT.

C. Small Amounts of Paint Disturbance

As discussed in Chapter 6, unit II.C.3, of these *Guidelines*, EPA and HUD regulations state that lead-safe work practices and clearance are not required if the total amount of paint disturbed by the work is less than a small amount specified by each agency.

HUD's *de minimis* Threshold. In its regulations, HUD uses the classical legal term for this minimal amount, "*de minimis*." Requirements pertaining to worker qualifications also do not apply if the amount of work is *de minimis*. HUD's *de minimis* levels under its Lead Safe Housing Rule (LSHR; specifically at 24 CFR 35.1350(d)) are amounts up to:

- (1) 20 square feet on exterior surfaces;
- (2) 2 square feet in any one interior room or space; or
- (3) 10 percent of the total surface area on an interior or exterior type of component with a small surface area (such as window sills, baseboards, and trim).

EPA's Minor Repair and Maintenance Threshold. EPA's RRP rule has a larger exemption for minor repair and maintenance work on interiors (6 square feet per room) than HUD's *de minimis* threshold,

but it does not have a small-component aspect, and it limits minor work exempted from its rule to those types that will not cause high levels of dust generation. Specifically, EPA's RRP Rule does not cover minor repair and maintenance activities (40 CFR 745.83) in target housing that disrupt no more than:

- (1) 6 square feet or less of painted surface per room for interior activities, or
- (2) 20 square feet or less of painted surface for exterior activities, and

where none of the work practices prohibited or restricted by that rule (open-flame burning or torching of lead-based paint, using machines that remove lead-based paint through high-speed operation without HEPA exhaust control; and operating a heat gun on lead-based paint at or above 1100 degrees Fahrenheit) are used and where the work does not involve window replacement or demolition of painted surface areas.

HUD Guidelines Recommendation: These *Guidelines* recommend, however, that, because much old paint has some lead, the following practices should *always* be observed when disturbing paint in pre-1978 housing and child-occupied facilities, even if the amount of paint to be disturbed is *de minimis*, unless it is known that all layers of paint to be disturbed have been applied after 1977 or the paint is not lead-based paint:

- (1) Never use the prohibited methods of paint removal that are described in Section II.D, below; and
- (2) When disturbing paint in housing *occupied by children of less than 6 years of age and/or women who have informed the property owner or manager that they are pregnant*, always clean the work area thoroughly after finishing, preferably with HEPA vacuuming and wet cleaning, and keep residents and pets out of the work area while work is underway and until after the cleanup, and the clearance or cleaning verification, as applicable, has been passed.

D. Lead-Safe Work Practices

Lead-safe work practices are ways to perform paint-disturbing work so that occupants, workers and workers' families, and the environment are protected from exposure to, or contamination from, lead in dust, debris and residue generated by the work. Lead-safe work practices include the following:

1. **Do not use the following paint removal practices except as specified.** Workers should not use the following paint removal methods in HUD-assisted target housing; the methods lettered f and g are permitted in unassisted target housing:
 - a. **Open-flame burning or torching.** This can produce toxic gases that a HEPA filter cartridge on a respirator cannot trap (a second, organic, filter is necessary). This method can create high levels of toxic dust that are extremely difficult to clean up; and it can burn down a house.
 - b. **Operating a heat gun at surface temperatures at or above 1100 degrees Fahrenheit.** Operating heat guns at such high temperatures can release lead dust and fumes and induce large increases in the blood lead levels of young children (Farfel and Chisolm, 1990; also cited by EPA in the preamble to its final rule on Requirements for Lead-Based Paint Activities in Target Housing and Child-Occupied Facilities. 61 *Federal Register* 45777, August 29, 1996, at 45795.)

- c. **Machine sanding or grinding without a HEPA local exhaust control and a shroud.**
Machine sanding or grinding with both a HEPA local exhaust control attached to the tool, and a shroud that meets the following performance requirement is permissible. The shroud must surround the surface being contacted by the tool with a barrier that prevents dust from flying out around the perimeter of the machine, *and* attached to a HEPA vacuum. However, this work method should be conducted used only by workers trained in its use. Because some dust may still blow out around the perimeter of the machine, workers near the machine should wear half-face respirators (with N100 cartridge) at a minimum. Also, the work area should be completely isolated if the machine is used inside.
- d. **Abrasive blasting or sandblasting without HEPA local exhaust control.** These methods should be used only within an enclosure that contains the spread of dust, chips, and debris, and that has a HEPA exhaust. This work method should be conducted used only by workers trained in its use.
- e. **Manual dry sanding or dry scraping**, except that dry scraping is acceptable in conjunction with heat guns with surface temperature of less than 1100°F, or within one foot of electrical outlets, or when treating defective paint spots totaling no more than 2 square feet in any one interior room or 20 square feet on exterior surfaces.
- f. **Uncontained hydroblasting.** Removal of paint using this method can spread paint chips, dust, and debris beyond the work area containment. Contained pressure washing at less than 5,000 pounds per square inch (PSI) can be done within a protective enclosure to prevent the spread of paint chips, dust, and debris. Water run-off should also be contained. Because contained hydroblasting requires precautions that are beyond the scope of most courses in lead-safe work practices, it should only be used by certified lead abatement workers under the supervision of a certified abatement supervisor.
- g. **Paint stripping in a poorly ventilated space when using a volatile stripper that is a hazardous substance** in accordance with regulations of the Consumer Product Safety Commission (CPSC) at 16 CFR 1500.3 and/or a hazardous chemical in accordance with the OSHA regulations at 29 CFR 1910.1200 or 1926.59, as applicable to the work. (This practice is prohibited by HUD regulations but not explicitly by EPA regulations.)

Stripping with methylene chloride should be avoided. OSHA has found that adults exposed to methylene chloride “are at increased risk of developing cancer, adverse effects on the heart, central nervous system and liver, and skin or eye irritation. Exposure may occur through inhalation, by absorption through the skin, or through contact with the skin.” (62 *Federal Register* 1493 (January 10, 1997)). OSHA’s permissible exposure limit for methylene chloride in air was reduced in 1997 from 500 to 25 parts per million (29 CFR 1910.1052 for general industry, and the identical 29 CFR 1926.1152 for construction). Methylene chloride cannot be detected by odor at the permissible exposure limit, and organic vapor cartridge negative pressure respirators are generally ineffective for personal protection against it.

Alternative paint strippers may be safer but have their own safety and/or health concerns. All paint strippers must be used carefully. Always follow precautions provided by the manufacturer.

It is especially important that persons who use paint strippers frequently, use such chemicals in a well ventilated area. If good ventilation is not possible, professionals equipped with protective equipment should perform the work in accordance with CPSC regulations (16 CFR

1500.3) and /or OSHA's hazard communications standards (29 CFR 1910.1200 or 29 CFR 1926.59) and with any substance-specific standards applicable to the work.

CPSC and EPA recommend that persons who strip paint provide ventilation by opening all doors and windows and making sure there is fresh air movement throughout the room. See the jointly published booklet, *What You Should Know About Using Paint Strippers*, CPSC document 423 (<http://www.cpsc.gov/cpsc/pub/pubs/423.html>), and EPA publication EPA-747-F-95-002 (search at <http://nepis.epa.gov/> for publication number 747F95002).

2. Working wet. Keep the surface damp, except near electrical outlets and fixtures, so sanding, scraping, planing, etc. generate less dust and the dust that is created does not spread as far. When working wet, take care to avoid slippery conditions and electrical shock. Always use Ground Fault Interrupter (GFI) outlets when using power tools. When working on a ladder, do not allow the rungs of the ladder to get wet when spraying or misting. Also, do not get protective plastic sheeting wet; it can become slippery.
3. Protecting occupants and containing dust in the worksite. The worksite should be set up and occupants should be protected in accordance with the guidance in Chapter 8. This guidance varies with the amount of dust that is expected to be generated by the work. Generally, occupants should not be allowed in the work area until after the work is finished and the area is cleaned and either clearance has been passed or cleaning has been verified. Temporary relocation may be necessary. Personal belongings should be moved from the area or covered and sealed. Floors should be protected with plastic sheeting. For dusty jobs, dust should be contained within the room or rooms in which work is conducted by installing plastic sheeting over doors and sealing HVAC vents. Workers should not track dust from the work area to the rest of the dwelling. Waste and debris from the job should be wrapped or bagged and sealed and properly disposed of.
4. Specialized cleaning. After finishing the work, the worksite should be cleaned to assure that the site is free of dust lead hazards and can achieve clearance, or cleaning verification, if applicable. Guidance on cleaning is provided in Section IV of this chapter and Chapter 14. Vacuuming (with HEPA vacuums) and wet cleaning are recommended, and required in most instances.

E. Pre-Renovation Education

While education of the residents, particularly the children's caregivers, is not in itself sufficient to prevent childhood lead poisoning, it can assist residents in reducing the risk that their children will be seriously poisoned. Therefore, education is an important adjunct to any lead hazard control system. See Chapter 6, unit IV.C.6, for information on communicating with residents. See Appendix 6 for information on the EPA's Renovation, Repair, and Painting (RRP) Rule, and HUD's Lead Safe Housing Rule (LSHR), both of which have pre-renovation education provisions.

EPA's RRP rule (most of which is found at 40 CFR Part 745, Subpart E) requires that persons who perform renovation, repair or painting (called, in brief, "renovation") of most pre-1978 housing for compensation provide a lead hazard information pamphlet to owners and residents affected by a renovation within 60 days before beginning the work, describe how, where and when the project will be conducted (and update notify if any of this changes), and, if the work is being conducted in common areas, ensure written notification to each affected unit with the information above and describing how the occupant can obtain the pamphlet, at no charge, from the firm performing the

renovation (40 CFR 745.84). Renovation is defined in the regulation as “the modification of any existing structure, or portion thereof, that results in the disturbance of painted surfaces, unless that activity is performed as part of an abatement” (40 CFR 745.83). Detailed information on implementing pre-renovation education is provided in the EPA’s *Small Entity Compliance Guide to Renovate Right*, a handbook on the RRP rule for contractors, property managers and maintenance personnel working in homes and child-occupied facilities built before 1978 (EPA publication EPA-740-K-10-003; www.epa.gov/lead/pubs/sbcomplianceguide.pdf).

This pre-renovation education requirement does not apply to activities are minor repair and maintenance activities (see section II.C, above), emergency renovations, renovations of components that have been found by a certified lead-based paint inspector to be free of lead-based paint, or renovations of housing that is exempt from Title X. Title X exemptions from “target housing” covered by its regulations include: housing built after 1977, housing that is designated as exclusively for the elderly or for persons with disabilities (provided no child of less than 6 years does resides there), and zero-bedroom units.

The pamphlet that must be distributed is the EPA lead pamphlet, *Renovate Right: Important Lead Hazard Information for Families, Child Care Providers and Schools* (“Renovate Right”), or an alternative state or tribal pamphlet approved for this purpose by EPA. The information contained in the lead renovation pamphlet that is given to owners and occupants before beginning the renovation should be provided in appropriate format(s) to meet the needs of all residents including persons with limited English proficiency and in formats that may be needed for persons who are visually or hearing impaired (Executive Order 13166, derived from Title VI of the Civil Rights Act of 1964).

Copies of “Renovate Right” can be obtained from the National Lead Information Center, at 1-800-424-LEAD (hearing- or speech-challenged individuals may access the NLIC number above through TTY by calling the toll-free Federal Information Relay Service at 800-877-8339), or by downloading it from the EPA’s or HUD’s web site. As of the publication of these *Guidelines*, the pamphlet is available in English and Spanish.

- ◆ On the EPA website, the English version is available at <http://www.epa.gov/lead/pubs/renovaterightbrochure.pdf>, and the Spanish version, at <http://www.epa.gov/lead/pubs/renovaterightbrochure-esp.pdf>.
- ◆ On the HUD website, the English version is available at http://portal.hud.gov/hudportal/documents/huddoc?id=DOC_12531.pdf, and the Spanish version, at http://portal.hud.gov/hudportal/documents/huddoc?id=DOC_12532.pdf.

Further information on the Pre-Renovation Education (PRE) Rule, as it has been modified by the RRP Rule, is available at the PRE Rule’s website, www.epa.gov/lead/pubs/leadrenf.htm.

F. Resident Protection and Worksite Preparation During Control Activities

Any activity that disturbs lead-based paint can generate leaded dust. Before beginning paint-disturbing work, workers should set up dust containment to fit the job in accordance with guidance provided in Chapter 8. Whenever dust-generating activities are carried out, residents and particularly young children should stay out of the contained area and should not return until all dust, debris and residue are removed and the containment area or the dwelling unit has been thoroughly cleaned and cleared (see details in Chapter 8). If the work disturbs no more than a *de minimis* amount, described in Section II.C, above, elaborate measures to protect occupants are not

necessary. But, it is always best practice to keep occupants out of the work area until after cleanup, and prohibited methods of paint removal should never be used.

G. Worker Protection

Workers should be protected from exposure to lead by using lead-safe work practices, wearing protective clothing, practicing personal hygiene, and, where these measures are insufficient, using additional engineering controls and, if needed, respiratory protection. Chapter 9 addresses this information in detail.

Some control measures may vary depending on the amount of dust that is expected to be generated by the work. A high dust, paint-disturbing job is defined in Chapter 8 as generally one in which dust caused by the work spreads more than five feet from the work surface. These extensive protections are usually not necessary for very small maintenance jobs. Lead-safe work practices described in Section II.D, above, reduce the amount of dust created by the work and the likelihood of worker exposure.

These protective measures will also help to protect workers' families. Contaminated clothing, shoes or boots brought outside of the worksite, and unwashed hands and other exposed skin surfaces, can result in lead contamination and poisonings from exposure to lead in workers' homes or cars.

H. Waste Handling

EPA has interpreted the household exemption of the Resource Conservation and Recovery Act (RCRA) as applying to all lead-based paint activities, including abatement, interim control, renovation, and remodeling of housing (EPA, 2000x). In 2003 EPA amended its solid waste regulations to codify this policy (EPA, 2003w). A summary fact sheet (publication EPA-530-F-03-007), is available through EPA's website RCRA Online at www.epa.gov/epawaste/nonhaz/municipal/landfill/lbp_fs.pdf. For these purposes, types of housing included under the household waste exemption include multi-family buildings as well as single-family homes. Nevertheless, these *Guidelines* strongly recommend that persons conducting lead-based paint activities treat bulk waste (e.g., painted architectural components being replaced), paint chips, dust and waste water in accordance with the guidance in Chapter 10.

I. Cleanup

These *Guidelines* recommend cleanup at three stages of paint-disturbing work: (1) before the work begins, (2) during the work, and (3) after completion of the work (the final cleanup). Project supervisors should ensure workers should follow the guidance on cleanup during each stage that is provided in Chapter 14, especially its sections IV.B and C,.

J. Clearance

Clearance examinations (including a visual inspection for residual dust, debris and residue) must be conducted following abatement in target housing. (Chapters 12 and 15 describe abatement and clearance examinations, respectively.) Clearance is required after interim control work in target housing receiving federal assistance, unless the interim control work disturbs less than the HUD-specified *de minimis* amount of paint, described in Section II.C, above, and in Chapter 6, unit II.C.3.

These *Guidelines* recommend clearance in other pre-1978 housing even when not required by regulation, such as in most target housing that is not federally-assisted. For projects in unassisted target housing that are not minor repair and maintenance work, EPA requires a visual inspection for residual dust, debris and residue, followed by either clearance or cleaning verification, a visual comparison of the darkening of wet disposable cleaning cloths by wiping them over windowsills, uncarpeted floors, and countertops with the darkness of a reference cleaning verification card, as a means of determining whether post-renovation cleaning has been properly completed (40 CFR 745.85(b)). (See Appendix 6 for more detail.)

K. Notification to Occupants of the Results of Hazard Evaluation and Control

Two Federal regulations require that occupants of housing be informed about lead-based paint or lead-based paint hazards in their homes.

One is the lead-based paint disclosure regulation (Lead Disclosure Rule) issued jointly by HUD (24 CFR part 35, subpart A) and EPA (40 CFR part 745, subpart F). The Lead Disclosure Rule applies at the time of sale or lease of housing built before 1978; some exclusions apply (see Appendix 6 for more information). The Lead Disclosure Rule also applies at the time of lease renewal, if new information is available. Further information on the disclosure rule is available from HUD and EPA and can be found on the Internet at either www.epa.gov/lead/pubs/leadbase.htm or http://portal.hud.gov/hudportal/HUD?src=/program_offices/healthy_homes/enforcement/disclosure.

Relevant information includes the findings of evaluations (i.e., risk assessments, lead-based paint inspections, and other testing), clearance examinations, and actions taken to reduce any hazards (including interim controls, abatement, or standard treatments). This gives residents the information they need to protect themselves from inadvertent exposure to lead in the home.

In addition to the Lead Disclosure Rule, HUD requires, under its Lead Safe Housing Rule (at 24 CFR 35.125), that occupants of housing receiving Federal assistance be notified of the results of evaluations and hazard reduction activities, including clearance.

- ◆ A notice of evaluation or presumption of lead-based paint must be provided within 15 days after the owner or other responsible party receives the evaluation report or makes the presumption. The notice of evaluation must include:
 - (1) a summary of the nature, scope, results, and date of the evaluation,
 - (2) a contact name, including address and phone number, for more information and to obtain access to the complete report and
 - (3) the date of the notice.
- ◆ A notice of hazard reduction activity must be provided within 15 days after the work is completed and the clearance examination report has been received. The notice of hazard reduction must include:
 - (1) a summary of the nature, scope, and results (including clearance) of the work;
 - (2) a contact name for more information, including address and phone number;

- (3) available information on the location of any remaining lead-based paint in the rooms, spaces, or areas where work was performed on a surface-by-surface basis; and
- (4) the date of the notice.

Notices can be provided to the occupants by either:

- ◆ posting and maintaining them in a centrally located common area, with distribution to any dwelling unit where the head of household is disabled; or
- ◆ distributing to each occupied dwelling unit (HUD does not require a signed acknowledgment of receipt).

EPA requires, under its RRP Rule (at 40 CFR 745.86(d)), that, if dust clearance sampling is performed, the renovation firm must provide, within 30 days of the completion of the renovation, a copy of the dust sampling report to the person who contracted for the renovation. These *Guidelines* recommend that the person who contracted for the renovation provide at least a summary of the results to residents of the affected dwelling unit(s) within 15 days after receiving the results.

L. Ongoing Lead-Safe Maintenance

The success of interim control measures depends not only on the adequacy of their initial application, but also on whether they remain effective over time. To remain effective they must be maintained and monitored. Residents should be asked to report deteriorating paint. Property owners, or their agents, should routinely (e.g., annually) visit the property and visually ensure that interim controls remain in place. They should also respond promptly whenever an occupant reports any deteriorating paint. Any failure of interim controls that is identified should be corrected promptly. Common areas should be included in these activities as well as dwelling units. See Chapter 6 for a complete discussion of ongoing lead-safe maintenance.

The HUD Lead Safe Housing Rule (24 CFR Part 35, subparts B through R) requires ongoing maintenance in most target housing receiving HUD assistance, with exceptions for assistance in which HUD does not have an ongoing relationship with the property, e.g., disposition of HUD-owned single-family housing, and rehabilitation other than under the HOME program.

M. Reevaluation

These *Guidelines* recommend, and the Lead Safe Housing Rule requires for most HUD housing assistance programs, that a certified risk assessor conduct a reevaluation if hazard reduction has been conducted to reduce lead-based paint hazards found in a risk assessment or if standard treatments have been conducted (24 CFR 35.1355(b)). The schedule is two year intervals after completion hazard reduction until no lead-based paint hazards are found in two consecutive reevaluations. See Chapter 5, section VII, for guidance on reevaluation.

N. Documentation

Lead hazard evaluation, lead hazard control, and maintenance and monitoring activities associated with interim controls must be documented. Several specific documents are of particular importance. These include:

- ◆ **Risk Assessment and/or Inspection or Testing Reports.** These documents record the findings of any risk assessment or inspection, including any inspection or testing of painted surfaces and the collection and analysis of samples for determination of the lead content in dust, soil, and/or water. A risk assessment that finds no lead-based paint hazards would also justify issuance of a report.
- ◆ **Lead Hazard Control Plan.** This document explains the schedule of hazard control actions in multi-family housing (see Section II.A of this chapter).
- ◆ **Notices to Occupants.** This includes copies of notices to occupants of the results of hazard evaluations (risk assessments, lead-based paint inspections, or paint testing) and the results of lead hazard reduction activities, including clearance (see Section II.K of this chapter).
- ◆ **Description of Work Done.** For future reference, such as to help them implement the lead hazard control plan effectively, owners should have on file a written description of the nature and locations of the work, its starting and ending dates, who performed it, and any specific suggestions for monitoring. Owners or their property managers who performed, or whose employees performed, renovation work covered by the EPA's RRP rule must keep all records necessary to demonstrate compliance with that rule for at least 3 years after the end of the renovation (40 CFR 745.86). If the renovation work was performed by an outside firm, the owner or property manager should arrange to have ongoing access to those records; if the outside firm is planning to dispose of the records at or after the end of the 3-year period, the owner or property manager should arrange to obtain the records for further use in implementing the lead hazard control plan.
- ◆ **Clearance Examination Reports.** These documents record the basis for clearance of the property so that it is ready for occupancy (see Chapter 15). If the housing (or the renovation) is not federally-assisted, the renovation firm's client (typically, the property owner or manager) must be provided a copy of the dust sampling report within 30 days of the completion of the renovation; if the housing (or the renovation) is federally assisted, the property owner or manager must send the report to the affected occupants within 15 days. Cleaning verification is different than clearance; both require documentation.
- ◆ **Spot Test Kit Results Notification.** When spot test kits are used, the firm must notify its client of the manufacturer and model of the test kits used, the description and locations of the components tested, and the test kit results (see Chapter 15).
- ◆ **Reevaluation Reports.** These reports indicate whether the hazard control measures are still in satisfactory condition and whether the dwelling is still in a lead-safe condition. If problems are identified, they prompt corrective action. Reevaluations are performed on a schedule discussed in Section VII of Chapter 5.
- ◆ **Maintenance and Monitoring Log.** This log records the results of the property owner's or property manager's monitoring visits. Any repairs made as a result of these visits, or notices of defects from occupants, should also be recorded.
- ◆ **Other Applicable Records.** Retain records of worker training in lead-safe work practices, any personal air monitoring, if performed, and correspondence with state and local government agencies on matters such as childhood lead poisoning cases, regulatory compliance (e.g., HUD Lead Safe Housing Rule, EPA RRP rule, OSHA Lead in Construction standard, EPA/State/Tribal waste and lead regulations), or other related matters.

III. Paint Stabilization

How To Do It

1. **Fix moisture problems.** Before stabilizing the deteriorated component(s), eliminate any exterior leaks in the building envelope and any interior water leaks that may be causing paint deterioration. Exterior leaks include: roofing leaks, gutter or downspout problems; missing or damaged doors; missing or deteriorated roof flashing; missing opening trim; missing glass in windows; defective or missing caulk and glazing; poor drainage at foundation walls; and loose fasteners. Interior water leaks include: plumbing leaks; clogged condensation drip lines for air conditioners; missing water pans for hot water heaters; inadequately ventilated attic spaces; clogged bathtub drains; missing tile, grout, or caulking in bathtubs; and windows that won't close completely.
2. **Prepare worksite.** Select and implement worksite preparation and occupant protection measures in accordance with guidance in Chapter 8.
3. **Soil sampling (optional).** For exterior paint disturbing work, if the owner or contractor wishes to document that the work does not increase soil lead levels above applicable standards, collect soil samples near the work surfaces before the work begins. These samples need not be analyzed unless samples collected after completion of the work show soil lead levels above applicable standards. This is an optional procedure that is appropriate if pre-work soil samples are not being taken as part of a risk assessment and if there is a special concern regarding the level of lead in the soil.
4. **Repair substrate.** Repair all rotted structural, siding, or railing components; defective plaster; missing door hardware; loose siding or trim; and loose wallpaper.
5. **Remove loose paint.** Prepare surface by wet scraping or wet sanding. Do not use prohibited methods of paint removal: Open-flame burning or torching, operating a heat gun at surface temperatures at or above 1100 degrees Fahrenheit, machine sanding or grinding without a HEPA local exhaust control and a shroud, abrasive blasting or sandblasting without HEPA local exhaust control, manual dry sanding or dry scraping, uncontained hydroblasting, paint stripping in a poorly ventilated space when using a volatile stripper that is a hazardous substance. (See Section II.D, above.)
6. **Other surface preparation.** Clean, degloss, neutralize (if a caustic paint stripper has been used), and rinse surfaces. Surfaces should be dry before priming or repainting.
7. **Select paint.** Select primer and top-coat by considering longevity, moisture resistance, and organic compound content with low volatility. Paint stabilization involves the application of at least two coats (the primer and the top-coat). Use a primer/top-coat system from the same manufacturer to ensure compatibility.
8. **Apply paint.** Apply all paints at appropriate thickness and according to manufacturer's directions. Apply paint only during proper temperature, wind, and humidity conditions. Allow sufficient time for each coat to dry fully.
9. **Cleanup.** Conduct final cleanup (see The Basic Steps Common to Most Jobs – How to Do It, items 8 and 9, on cleanups, above, and Chapter 14). Consider using a pre-clearance screen if the clearance area may have had high lead levels before the work and/or has rough horizontal surfaces that may make clearance difficult.

10. **Clearance.** At the end of the lead hazard control project, have a certified lead-based paint inspector, risk assessor, or sampling technician conduct a clearance examination and provide appropriate documentation. (See The Basic Steps Common to Most Jobs – How to Do It, item 10, on clearance, above, and Chapter 15.) (If clearance is not required and the project is covered by the EPA's Renovation, Repair, and Painting (RRP) Rule, conduct cleaning verification.)
11. **Ongoing lead-safe maintenance.** Perform ongoing lead-safe maintenance in accordance with guidance in Chapter 6. If required by regulation or the property owner or manager's preference, conduct reevaluations every two years in accordance with guidance in Section VII of Chapter 5.

A. Typical Lead Containing Coatings and Their Failures

The lead in lead-based paint may be found as white pigments (lead carbonate, sulfate, or silicate) or colored pigments (chrome yellow, red lead, gray, and other orange, green, and red pigments).

These pigments were mixed with other components in an oil vehicle, and traditionally thinned with volatile organic solvents and a drying agent. Driers containing lead were used to accelerate the conversion of the liquid coating to a dry film. Paint can fail rather quickly under real life conditions, making ongoing monitoring important. Paint should be quickly, but carefully, stabilized whenever a resident or owner reports that paint is deteriorating.

1. Moisture

Oil paints (virtually all lead-based paints are oil paints) form a hard, usually glossy, low permeable and inflexible coating. Water, either in the form of water vapor or liquid, is the single greatest cause of premature paint coating failures. Once a substrate gets wet, the impermeable paint coating is pushed away from the substrate due to vapor formed by heat from the sun or other sources. Repeated soaking/warming cycles result in microscopic failure of the paint and then accelerated failure as more and more openings become available, allowing the substrate to become increasingly wet.

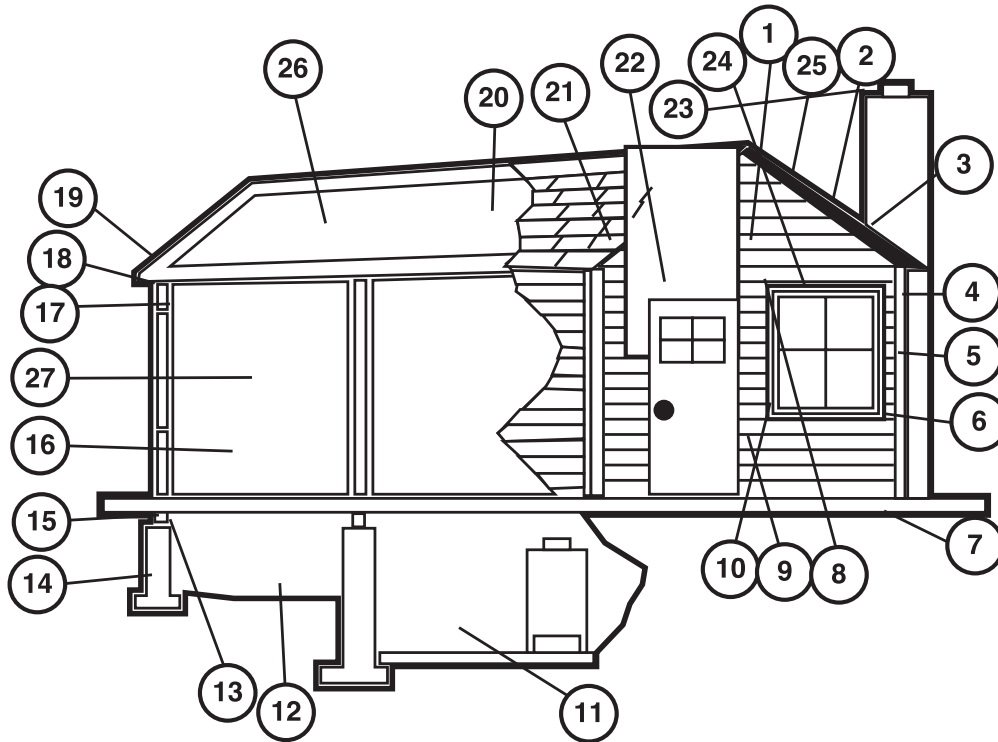
A significant number of homes are poorly constructed, ventilated, or maintained, and allow moisture to be trapped. Twenty-six main causes of premature paint failure from moisture are described in Figure 11.1.

2. Aging

All binders in paint age, and some cure over time. This continued curing causes the paint to become too brittle to accommodate the normal expansion and contraction of the substrate, resulting in cracking and peeling. Exterior paints are also attacked by sunlight, which can cause chalking. These slow aging processes mean that even a well managed and protected surface will deteriorate eventually.

3. Mechanical Damage

The two basic kinds of mechanical damage (abrasion and impact) can be minimized only by careful management. Paints exhibit tremendous variability in hardness, impact resistance, and abrasion resistance. High performance coatings (e.g., polyamide epoxy, urethane-reinforced alkyds, and epoxy-modified enamels) can withstand over 10,000 more scrubbing cycles than



Key to pointers in Figure 11.1:

- | | |
|---|---|
| <ul style="list-style-type: none"> (1) siding exceeds 14-percent water content (2) no cricket where chimney meets roof (3) no step flashing at side of chimney (4) corner rim not caulked (5) exposed nail heads rusting (6) no window wash at window sill (7) wood contacts earth (8) no drip or gutter at eaves (9) poorly fitted window and door trims (10) waterproof paper not installed behind trim (11) damp, wet cellar unventilated at opposite sides (12) no ventilation of unexcavated space (13) no blocking between unexcavated space and stud wall space (14) no waterproofing or drainage tile around cellar walls | <ul style="list-style-type: none"> (15) no foundation water and termite sill (16) plaster not dry enough to paint (17) sheathing paper that is not waterproof; (18) vapor barrier omitted – needed for present or future insulation (19) roof built during wet, rainy season without taking due precaution or ventilating on dry days (20) roof leaks (21) inadequate flashing at breaks, corners, roof (22) poorly matched joints (23) no chimney cap (24) no flashing over openings (25) full of openings, loosely built (26) no or inadequate ventilation of attic space (27) plumbing leaks. |
|---|---|

FIGURE 11.1 Moisture-Related Causes of Paint Failure

inexpensive flat vinyl paints (Banov, 1978), although some of these paints may not be appropriate for residential use. Failure from impact or friction is often accelerated by the selection of a low performance coating.

4. Chemical Incompatibility

Since oil and water do not mix, oil paints applied over wet substrates will not adhere. The failure may occur within a week, and may cause the paint to be pulled directly from the substrate. Although oil paints stick relatively well on surfaces slightly contaminated with organic material, dirt, and oil, they do not adhere well to fatty or heavily greased surfaces.

Most latex paints do not adhere to chalky, or smooth and glossy paint. Epoxies will fail prematurely when applied over latex coatings and some oil coatings. Some chemical based strippers contain such large amounts of wax and other stabilizers that almost no subsequent coating will maintain good adhesion. If the substrate has been stripped with a caustic paste and not neutralized properly, the highly alkaline pH will cause deterioration of the subsequent paint. On the exterior, salts may build up on the surface of paint in eaves and soffits and prevent paint adhesion. These salts must be removed with water to allow good adhesion.

Portland cement and older plaster substrates are extremely alkaline. They should be aged or etched with mild acid solutions prior to spot sealing with a primer.

5. Poor Surface Preparation

A 100 year-old house, repainted every 8 years, may have at least 12 coats of paint. If surface preparation for only one of those coats was insufficient, paint will peel. Because of the slow erosion of the binder in exterior paints, chalking can cause poor adhesion of new coatings. Chalking results from natural degradation of the organic binder and consequent exposure of unbound pigment particles on the paint surface that rub off easily like chalk. Chalk must be washed off and appropriate primers applied to prevent subsequent failures. Surfaces must be free from oil, grease, and dirt. Paint stripper residue must be removed, either with solvents or alkali cleaners. Hard, glossy oil films require deglossing to allow water borne coatings to adhere properly.

B. Substrate Condition and Repairs

1. Building Envelope Leaks

The quality and endurance of a paint coating is dependent on the quality of the substrate over which it is applied. The substrate must be dry, structurally sound, and waterproof. Roofing leaks, including porches, gutters, and downspouts, must be fully repaired prior to stabilizing the lead-based paint. Temporary roofing repairs like asphalt patching material, piecing in downspouts and gutters, and short term paint-on coatings are not recommended. Within 4 months, these quick fixes may fail and result in the subsequent failure of the lead-based paint.

In lead-based paint stabilization, the main goal is to create an intact coating that prevents excessive lead exposures. Paint stabilization is most effectively and economically completed after defects, such as the following, have been fully corrected:

- ✦ Damaged or missing roof flashing.
- ✦ Damaged or missing door or window flashing.
- ✦ Siding in contact with soil.
- ✦ Poor drainage at foundation walls.
- ✦ Water running down siding in excessive amounts, due to a broken or clogged gutter or downspout.
- ✦ Missing or deteriorated trim around openings.
- ✦ Missing glass in windows.
- ✦ Missing, damaged, or deteriorated caulking.
- ✦ Loose and rusty fasteners.

2. Interior Repairs and Water

The major type of repair that must be completed prior to paint stabilization involves eliminating moisture sources. Plumbing leaks, especially in bathrooms and kitchens, are often the cause of paint failure on the ceilings and walls below. A few major soak/dry cycles can bring the lead-based paint or leach lead salts to the surface.

Because excessively long hot showers in inadequately ventilated bathrooms may result in paint damage, paint stabilization may not last long if these continue to occur routinely. The ventilation in the bathroom may need to be increased; but see Section II.L, below, and Chapter 6, Section III.C.7, about informing residents on their helping avoid this problem.

The following interior defects should be corrected permanently in conjunction with interior lead-based paint stabilization projects:

- ✦ Visible leaks in waste lines, traps, supply lines, or plumbing fixtures above or in rooms undergoing stabilization, or where suspected lead-based paint is present.
- ✦ Clogged condensation drip lines for air conditioners.
- ✦ Water heaters, refrigerators, or washers without pans and overflows above or in rooms undergoing stabilization or where suspected lead-based paint is present.
- ✦ Inadequately ventilated attic spaces.
- ✦ Inadequately ventilated bathrooms, kitchens, and laundry areas.
- ✦ Clogged bathtub drains.
- ✦ Interior windows that are loose or do not close completely.
- ✦ Broken or missing glass in windows.
- ✦ Improper or deteriorated caulking in bathrooms and kitchens.
- ✦ Plugged or blocked weep holes in storm windows.

3. Water Vapor Management

Paint exposed to excess water vapor can fail within hours of initial application. Almost all exterior trim flashing and caulking serves a functional purpose by covering seams and joints and keeping out air and water. All missing or deteriorated trim, flashing, and caulking should be replaced prior to stabilizing the deteriorated component(s). In addition to keeping water from entering through the building envelope, it is equally important that the walls and roof be able to dry should they get wet. Exterior cladding and attic spaces should be ventilated to allow the escape of water vapor. Small wedges can be driven between clapboards at each stud (circle vents are of questionable effectiveness), or the walls may be sealed from the inside using caulking and a very low permeable primer. Soffit and ridge ventilation of at least 1 square inch of vent per 300 square inches of ceiling area is recommended. While venting the attic space, it is important also to seal all openings in the ceiling between the interior and the attic so: (1) the attic venting does not pull moisture from the interior into the attic space where it can condense and cause damage or (2) moisture is not pulled from the exterior into the attic and then into the living space when furnace, dryer, and ventilation fans are pulling air out of the interior of the home.

Open cracks in bathrooms and kitchens should be taped with fiberglass mesh wall tape, spackled, and then sealed to eliminate water penetration. Minor repairs to the plaster substrate should be completed, allowed to dry, and sealed with white shellac or acrylic latex.

The following vapor maintenance defects should be permanently corrected prior to stabilizing lead-based paint:

- ◆ Deteriorated or missing caulking or grout at tub and shower surrounds.
- ◆ Painted over vents on siding or roof.
- ◆ Deteriorated or missing caulking that allows air infiltration (e.g., at trim, outlets, light fixtures, pipe penetrations).
- ◆ Uncovered crawl spaces with low permeable vapor barriers. Crawl spaces can be dried by first reducing humidity, removing any standing water, and then applying 6-mil polyethylene plastic sheeting to the floor of the space, especially if it is soil, after all debris has been removed and the soil graded as evenly as possible. The plastic sheeting should go up the side walls of the crawlspace to just above outside grade level. Lapping the seams at least 12 inches or taping the seams is preferred. If there is a heated basement area, it may be possible to eliminate crawlspace vents, insulate the perimeter of the crawlspace, and open the space to the heated basement.

4. Substrate Repairs

Prior to stabilizing lead-based paint, defects such as the following should be permanently corrected:

- ◆ Dry rotted or rusty structural, siding, or railing components.
- ◆ Wall and ceiling plaster that is loose from the underlying lath (sagging plaster).
- ◆ Loose siding or trim.
- ◆ Loose wallpaper.

C. General Paint Application Guidelines

1. Appropriate Conditions

Because the guidelines in this chapter have been developed primarily to stabilize and seal lead-based paint, the general requirements for repainting should be rigorously followed. Painters should be professional, skilled, and willing to guarantee their work. Strict adherence to the paint manufacturers' recommendations for air and substrate temperatures, required primers, relative humidity, and recoating time should be conscientiously enforced. The completed primer and top-coat must be applied at the manufacturers' coverage rate, and the total coating thickness should never be thinner than 2.5 mil.

2. When Paint Stabilization Will Not Last Very Long

Under certain conditions, paint stabilization will not last very long. These conditions include:

- ◆ When prerequisite repairs are not possible.
- ◆ When there is a high probability of future physical damage. One possible example is walls of a narrow stairwell that have visible physical damage from continual bumping, scratching or abrasion. Enclosure with wood wainscot is an acceptable alternative to paint stabilization (as long as the narrower width still meets code requirements).
- ◆ Lead paint on children's play equipment. Better options are removal of paint or disposal of equipment.
- ◆ Wall surfaces that are structurally unsound.
- ◆ Walls with a layer of wallpaper over or under lead-based paint. If there are areas of wallpaper that are not intact to the substrate, consider covering these with fresh wallpaper after removing and patching loose areas, or steaming off the wallpaper, patching the substrate, and starting anew.
- ◆ Weep holes in storm windows not cleared to allow ventilation and drainage of water.

Paint stabilization will yield the best results when the surface and building system have been properly prepared. If prerequisite repairs cannot be completed before paint stabilization, the reevaluation period should be shortened substantially. The owner's monitoring frequency should also be increased.

3. General Recommendations for Applying Paint

- ◆ Paint only when surface and ambient temperatures are between 45°F and 95°F.
- ◆ Do not paint in direct warm sunlight. Very warm temperatures accelerate the drying time of the paint and may compromise the longevity of the paint. Paint after the sun has passed, or so that the paint is nearly dry before the direct sunlight reaches it.
- ◆ Maintain coatings in container at a temperature range of 65°F to 85°F at all times on the job.

- ◆ Paint only when the temperature is expected to stay above freezing.
- ◆ Paint only when wind velocity is below 15 mph.
- ◆ Paint only when relative humidity is below 80 percent.
- ◆ Observe the recommended spread rate for the coating.
- ◆ Tint each coat differently if the same paint is to be used for successive coats to ensure complete coverage.
- ◆ Allow sufficient time for each coat to dry before applying another. Use the same brand for each coat.
- ◆ Allow adequate time for the top-coat to dry before permitting clients to reoccupy the space.
- ◆ Do not put doors back into use until they have dried completely.
- ◆ Do not paint over weep holes in the bottom of storm window systems. If the weep holes are blocked or plugged, drill a hole to permit proper ventilation and drainage of rainwater. Failure to clear weep holes will cause premature paint failure in window troughs.

D. Worksite Preparation

See Chapter 8, Section III, Worksite Preparation, for subsections B, on interior worksites, C, on exterior work, and/or D, on windows, as applicable to the project.

Soil sampling is an optional procedure, both before and after the work (see Chapter 15). For exterior work, soil samples may be collected before the work begins if the owner or contractor wishes to document that the work does not increase soil lead levels above applicable hazard standards. These samples need not be analyzed until soil samples have been collected *after* the work has been completed, and such post work samples have been analyzed and compared to soil lead hazard standards. If the lead in soil samples collected after the work has been completed are below applicable standards, the samples collected before the work do not need to be analyzed.

E. Surface Preparation

The recommended approaches to surface preparation are as follows:

- ◆ All loose surface material should be removed by hand treatments (i.e., wet scraping, wet sanding, or dry scraping with HEPA vacuum exhaust attachment).
- ◆ Surface contaminants that prevent adhesion should be eliminated by cleaning (e.g., chemical degreasing, or equivalent household cleaning agent, followed by thorough rinsing).
- ◆ Surface gloss should be eliminated by chemical etching, wet sanding, or HEPA vacuum assisted sanding.
- ◆ Adhesion to the substrate should be enhanced by chemical etching, applying rust inhibitors, spot sealing, and/or wet sanding.

1. Paint Removal Practices.

Do not use the prohibited paint removal practices described in Section II.D, above.

Wet Scraping. The goal of safe scraping is to minimize the creation of dust while removing loose paint. The best tool for this work is a scraper attached to a HEPA vacuum that very efficiently removes small dust particles generated during scraping.

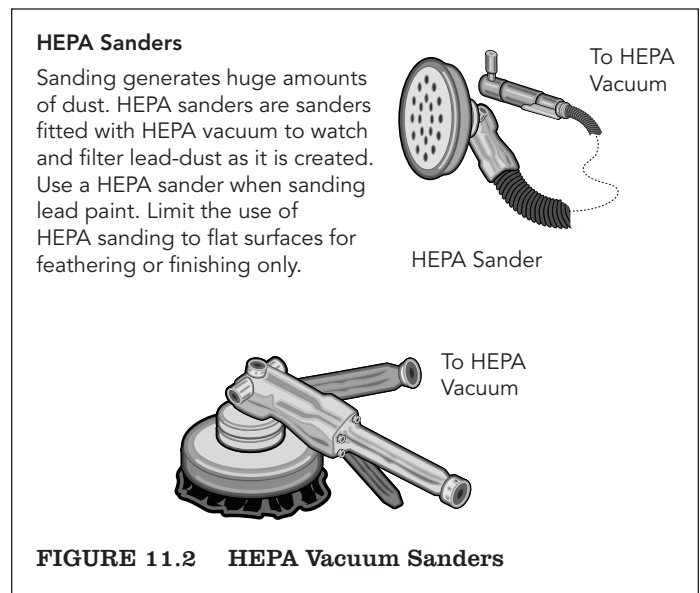
Large chips that fall to the floor are captured by the puncture resistant, disposable protective sheeting used for floor containment. Continuously misting the surface with water from a small atomizer or garden type sprayer reduces dust generation. A small amount of detergent can be used as a wetting agent. This procedure is best completed by two people – one scraping, the other wetting the surface. Simple dust gathering devices, like a damp rag wrapped around the head of a draw scraper, capture the smallest dust particles while directing the larger paint chips onto the floor containment area.

When working on a ladder, the steps or rungs of the ladder should be kept as dry as possible to avoid slippage. The ladder should not rest on the disposable, impermeable sheeting that is protecting the ground. Slits should be cut through the sheeting so the feet of the ladder can be secured to a firm base, or the feet of the ladder can rest on plywood that is put on top of the protective sheeting. If slits are cut in the protective sheeting, seal them with tape after moving the ladder. Many contractors have found that it is more efficient to rent lifts for high exterior work than to work from ladders.

Wet Sanding. When preparing a surface by sanding (especially with fine finishing grits), it is quite possible to contaminate an entire household with fine particles of lead-contaminated dust. Traditional orbital sanding devices may be used *only* in conjunction with a HEPA vacuum filter attachment (see Figure 11.2). Dry sanding should be replaced by wet sanding *except* near electrical circuits.

Any liquid that does not interfere with subsequent paint adherence may be used (e.g., water, Varsol, phosphoric acid etch for iron). Use sponges to wet sand patching material for drywall, plaster, and wood.

Wood, metal, and painted surfaces that require a fine cosmetic finish may be sanded using wet-dry sandpaper and water or an oil paint solvent. Relatively rough surfaces may be finished using wet foam sanding blocks created by dipping a sponge in aluminum oxide grit. These sponge sanders are ideally suited for wet sanding and can be easily cleaned by immersing in a bucket of cleaning solution.



Rather than wet sanding or HEPA sanding to degloss paint, the painter may chemically treat the surface with specialized products such as Liquid Sandpaper™, taking care to provide adequate ventilation if volatile substances are released.

2. Cleaning Surfaces of Dust and Chips.

Good surface preparation will remove damaged, oxidizing, and deteriorated paint surfaces, but will also create dust and chips that may be leaded. Therefore, after the surface has been allowed to dry, it should be vacuumed to collect surface dust. Prior to applying primer, the surface should be tested for its pH by placing litmus paper against the wet surface. The surface must be rinsed with clear water, or a weak acid solution, until it reaches a pH between 6 and 8 for most new paints.

Oils, Waxes, and Mold. While oil and alkyd paints have some tolerance for oil in the substrate, acrylic latex paints will fail prematurely if applied over greasy or oily surfaces. For waxes like crayons and some polishes, a combination of household ammonia and water should be used for cleaning, followed by a thorough rinse. Surfaces in baths and kitchens that may be prone to contamination by airborne grease and oils, or fatty soap can be cleaned with a suitable household cleaner and rinsed thoroughly. Remove mold with soap and water. For guidance on removing mold, two EPA documents may be helpful: *A Brief Guide to Mold, Moisture, and Your Home* (EPA 402-K-02-003) and *Mold Remediation in Schools and Commercial Buildings* (EPA 402-K-01-001) which can be found at www.epa.gov/mold/moldresources.html (see References for additional ordering information). On some varnished kitchen cabinets, the finished surface may become coated with organic films after extended use. The surface should be cleaned with a nonflammable solvent before painting.

F. Priming

To maximize the life of a paint job, a system of compatible coatings is necessary. Primers are designed to adhere tightly to the old paint while leaving a rough, bondable surface on the outside. Prior to priming wood and plaster, substrates should be dry. Top quality primers work better, last longer, and treat more substrate types. Consider the following factors when selecting a primer:

- ◆ Type of substrate (e.g., wood, metal, gypsum, masonry).
- ◆ Type of existing substrate coating (e.g., acrylic latex paint, varnish, oil enamel).
- ◆ Interior or exterior application.
- ◆ Top-coat (use manufacturers' recommended primers; use a single manufacturer for both primer and top-coat).

1. Oil- and Alkyd-Based Primers

Oil primers are compatible with a system of multiple coats of oil paint over a wood or plaster substrate. The similar solvents used in the old and new paints tend to soften the surface of the paint, creating a better bond. Oil primers are also effective vapor barriers. On the other hand, oil primers contain volatile organic chemicals that can cause adverse health effects and may cost more than waterborne paints. Many states regulate the amount of volatile organic chemicals in paint.

2. Waterborne Primers

The most durable waterborne paints are made with an acrylic or acrylic-containing binder. While acrylic latex primers and top-coats are an excellent combination for new wood, they may not be compatible with the lead-based oil paints that cover the substrate. Waterborne paints usually emit less volatile organic compounds and may be less expensive than oil paints.

G. Top-coats

To maximize cost-effectiveness and prolong the efficiency of a coating used as a lead hazard control method, it is important to purchase paint with a long lifespan. Inexpensive, low grade paint or special mixes should not be used in lead-based paint stabilization programs. Paints and clear finishes used for paint stabilization jobs require outstanding adhesion, durability, chemical resistance, and flexibility. Therefore, the owner should request the most durable and the highest grade of paint. (See Table 11.1 for finishes typically used for lead-based paint stabilization.)

Marine paints free of lead and mercury, and varnishes (used on boats, docks, etc.) are especially durable and abrasive-resistant. They are formulated with more resin than house paints and the resin is of the highest quality. However, some marine paints are not appropriate for residential use. For example, bottom paints or mildew-resistant paints contain poisons and must be avoided, so that lead is not replaced by another toxic substance.

Table 11.1 Finish Coats for Paint Stabilization

Options	Base	Difficulty Level	Comments and Recommendations
Varnish	Oil Alkyd resin, clear finish		Can be touched up very easily.
Acrylic latex	Water	Safest and easiest to use.	May not adhere to alkyd enamels.
Polyurethane resins:			
Alkyd	Oil-volatile organic solvent	Easy to apply. Very durable.	Cannot be touched up without sanding off gloss.
Moisture cured	Volatile organic	Harder to apply.	Needs adequate relative humidity.
Waterborne clear finish	Polyurethane water	Can be hard to apply.	Safer to apply than organic solvent containing coatings.

Source: Adapted from *A Consumer's Guide to Renovation, Repair and Home Improvement*, J. Wiley & Sons, 1991.

High gloss floor and deck enamels offer the next best level of protection. In general, the higher the gloss, the more durable, impact resistant, and moisture resistant the coating. Among types of paint finishes, gloss, semi-gloss, and eggshell coatings are much more resistant to abrasive cleaners and the detergents used in follow-up maintenance procedures than flat finishes.

A satisfactory service life of 4 to 10 years may be achieved with latex and alkyd-based paints (see Cassens and Feist, 1991, regarding 100 percent acrylic latex paint), although much more rapid deterioration can occur under adverse conditions. Low-cost non-acrylic latex may last less than 4 years. The additional material costs (126 percent to 200 percent) of high priced paints and any special primers are minimal when compared to the cost of performing more frequent paint stabilization.

High performance coatings applied properly to ideal substrates may offer a service life of 10 to 25 years. High performance coatings include epoxy-modified alkyds, epoxies, urethanes, epoxy-polyesters, and polyesters. However, these types of coatings should only be selected after consulting the manufacturer as to the specific intended use(s) and after considering the following factors:

- ◆ Possible presence in the new coating of lead, chromate, mercury, or other heavy metals (and other toxic substances).
- ◆ Compatibility with existing paint.
- ◆ Ability to be repainted in future maintenance operations (epoxies and urethanes are difficult to repaint).

Some lead-based paint encapsulants are made out of similar materials and may last longer than paints on some surfaces (see Chapter 13).

H. Cleaning and Clearance or Cleaning Verification

Containment removal, extensive cleaning, and a clearance examination are required following stabilization and repainting, unless cleaning verification will be undertaken at the end of the work, or unless the size of the project is below the applicable threshold (*de minimis* area for performing clearance, or minor repair and maintenance activities area for performing cleaning verification). These steps are an essential part of the paint stabilization process. (See Section II.I of this chapter and Chapters 14 and 15 for additional discussion of cleaning and clearance.)

For exterior work, if the owner or contractor wishes to document that the work did not increase soil lead levels above applicable standards, soil samples should be collected before work begins and again at clearance. See Section III.D, above.

I. Maintenance

Immediately after completion of any paint stabilization job, the paint begins the slow process of deterioration from mechanical damage, ultraviolet rays, rain, snow, and wind. A well-prepared substrate, which is primed, and top-coated with premium house paints, can withstand between 4

and 10 years of weathering in temperate climates. At the other extreme, a small scratch in a metal railing located in a coastal town may lead to extensive corrosion and major paint failure within a much shorter time. Assuming a proper paint job, paint life is directly related to the environment to which it is exposed. Cyclical changes in the environment are responsible for the greatest rate of paint destabilization. Rapid changes in temperature, moisture content, and relative humidity cause small stress cracks at joints and between dissimilar materials. Exterior paint life can be extended considerably by annual inspections and maintenance (spot scraping, spot priming, and top-coating deteriorated areas). While a new paint job on interior plaster and wood can last 5 to 10 years with only minor fading, repainting will be required much more frequently in dwellings with more wear and tear. Spot priming and spot top-coating as soon as any deterioration is noticed can extend the life of the interior surfaces.

IV. Treatment of Friction, Impact, and Chewable Surfaces

How To Do It

1. **Prepare worksite.** Select and implement the appropriate worksite preparation (see Chapter 8).
2. **Window treatments.** For windows, remove stop bead and parting strip and dispose of properly. Wet scrape deteriorated paint. If the window trough is badly weathered, cap with back-caulked aluminum coil stock. If necessary, repair window weight and pulley system. If further protection is needed, consider installing a new window channel or slide system. Re-glaze if necessary.
3. **Door treatments.** For doors, remove stop from jamb and dispose of properly. Remove door by pulling out hinge pins. Mist and plane door to eliminate friction points. Replace hinges if necessary. Reinstall door and install new stop. If door knob is banging against the wall, install doorstop on floor or wall.
4. **Stair treatments.** For stairs, install a hard, cleanable covering on treads (e.g., rubber tread guards). Carpeting may be used instead, but it must be securely fastened so that it does not cause abrasion. Stabilize paint on banisters, balusters, and newel posts.
5. **Chewable surfaces.** For chewable surfaces such as window sills, remove lead-based paint, or enclose with back-caulked aluminum coil stock, or encapsulate with puncture-resistant epoxy-based or similar material.
6. **Drawers and cabinets.** For drawers and cabinets, remove and replace cabinet doors or remove paint by offsite stripping. Strip paint from drawers and drawer guides or plane impact points and repaint. As an alternative, install rubber or felt bumpers at points of friction or impact.
7. **Floors.** At a minimum, stabilize lead-based paint on porches, decks, and interior floors with polyurethane or high quality abrasion-resistant paint. For a more durable treatment, cover with carpeting, sheet vinyl, or tile, or enclose or replace with new flooring.
8. **Cleanup.** Conduct final cleanup (See The Basic Steps Common to Most Jobs – How to Do It, items 8 and 9, on cleanups, above, and Chapter 14).

9. **Clearance.** Have a certified risk assessor, certified lead-based paint inspector, or certified sampling technician conduct a clearance examination. (See The Basic Steps Common to Most Jobs – How to Do It, item 10, on clearance, above, and Chapter 15.)
10. **Ongoing lead-safe maintenance.** Perform ongoing lead-safe maintenance and monitoring of treatments (see Chapter 6). Reevaluations, if required by regulation or the property owner or manager's preference, should be conducted by certified risk assessors at two year intervals (see Chapter 5).

A. Definition of Terms

1. Friction Surfaces

Friction surfaces are those surfaces covered with lead-based paint that are subject to abrasion, which may generate leaded dust. For a friction surface to be a lead-based paint hazard, as defined by EPA regulations at 40 CFR 745.65(a), there must be a dust lead hazard on the nearest horizontal surface (e.g., floor or interior window sill) underneath or below the friction surface. A dust lead hazard is defined by EPA as equal to or exceeding $40 \mu\text{g}/\text{ft}^2$ on floors or $250 \mu\text{g}/\text{ft}^2$ for interior window sills based on wipe samples. See Chapter 5 for more information on identification of friction surface hazards. The most critical friction surfaces are generally those portions of a window that are rubbed when the window is opened and closed (see Figure 11.3). The actual area(s) of adjacent surfaces that rub together should not be painted. This includes the jamb, stop bead, and parting strip, and sometimes the sash. Other common friction surfaces include tight fitting or rubbing doors, cabinet doors

and drawers, stairway treads and railings, and floors or stair treads painted with lead-based paint, including exterior decks and porches.

Friction surfaces on doors and windows will generate less leaded dust when they are kept in good operating condition and in a state of good repair. Friction surfaces can also often be covered with a temporary or permanent covering to eliminate the friction. The covering itself, however, must be abrasion resistant. However, if the component is deteriorated, it may be more cost effective to simply replace it than to attempt to treat friction surfaces (see Chapter 12).



FIGURE 11.3 Window before and after friction treatment.

2. Impact Surfaces

Impact surfaces are surfaces that tend to be bumped or banged repeatedly. To be a lead-based paint hazard that is associated with an impact surface, according to EPA regulations at 40 CFR 745.65(a), the surface must be painted with lead-based paint that is damaged or otherwise deteriorated as a result of impact from a related building component, such as a door knob that knocks into a wall, or a door that knocks against its door frame. Paint that is damaged as a result of misuse, such as from children banging toys against the wall, may be deteriorated paint. If that deteriorated paint is lead-based paint, it is a lead-based paint hazard, but it is not considered an impact surface.

Paint that is damaged as a result of impact can cause small chips of paint to become dislodged and fall to the floor, covering the floor with small amounts of loose lead-contaminated dust and chips. The most common impact surfaces are doors, and door jambs, and door trim (see Figure 11.4).

Impact surface problems can be lessened by re-hanging doors so they open and close properly, and by installing door stops with impact absorbing tips.

3. Chewable Surfaces

A chewable surface is an interior or exterior surface that a young child can mouth or chew (see Figure 11.4). A chewable surface is the same as an “accessible surface” as defined in Title X. Hard metal substrates and other materials that cannot be dented by the bite of a young child are not considered chewable.

According to EPA standards at 40 CFR 745.65(a)(3), a chewable surface is a lead-based paint hazard if the surface is coated with lead-based paint and there is evidence of teeth marks. Furthermore, these *Guidelines* take the position that it is not necessary to treat a chewable surface if a child of less than six years of age does not reside in, or regularly visit, the dwelling unit or common area.



FIGURE 11.4 Examples of impact surfaces (left) and chewable surfaces (right). The window sash has large teeth marks.

B. Lead Hazard Control Measures

The treatments described below require special construction and cleanup skills that should be implemented by trained personnel only.

1. Window Systems

If windows do not open and close smoothly, they may be a significant source of leaded dust and chips in the home. The following paragraphs describe interim control methods of reducing friction surface hazards associated with windows. It is generally acknowledged, however, that windows are the most complex components to treat short of replacement. Window paint tends to deteriorate more rapidly than other painted surfaces due to moisture, variations in temperature, and exposure to the elements. In addition, painted friction surfaces, including the jamb, stop bead, and parting bead may be abraded or "sanded" each time windows are opened and closed. If the wood becomes weathered, dust is trapped and is difficult to remove.

- ◆ Before beginning any window treatment, prepare the worksite in accordance with guidance in Chapter 8. Also, vacuum the interior sill and trough areas to remove any loose paint chips, dust, or debris (see Figure 11.5).
- ◆ For a typical double hung sash, mist the stop bead holding in the lower sash with water. Score the edges with a razor knife to facilitate its removal. Pry off the parting bead (see Figure 11.6), wrap it in plastic, and seal the package with tape for disposal. Next, remove the lower sash (see Figure 11.7), sash weights and stops (see Figures 11.8 and 11.9). The jamb, parting bead, sash, window trough, and peeling trim should be misted with water. Loose and flaking paint should be carefully scraped away, and repairs made (see Figures 11.10 and 11.11). Clean and reinstall the window (see Figures 11.12 to 11.14).



FIGURE 11.5 Prepare the worksite and pre-clean the window.



FIGURE 11.6 Remove parting Aboard.



FIGURE 11.7 Remove the bottom sash, sash weights and stops.



FIGURE 11.8 Remove sash controls/weights.



FIGURE 11.9 Window after removal of sash weights.



FIGURE 11.10 Rebuild damaged sash with filler or putty.



FIGURE 11.11 Wet plane edges of sash to fit new jamb liners.



FIGURE 11.12 Vacuum window again.



Figure 11.13 Fit sashes into jamb liners.

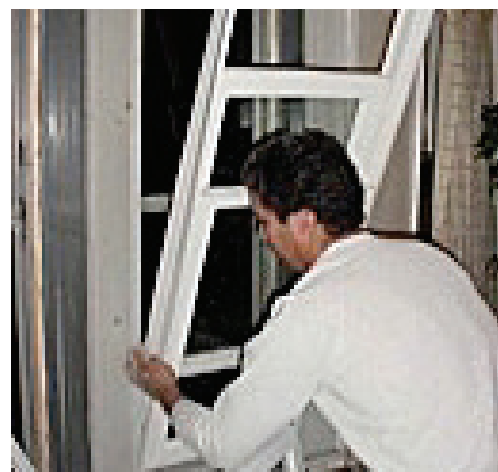


Figure 11.14 Reinstall sash into jamb.

- ◆ Vacuum all surfaces again, paying particular attention to the window trough. If badly weathered, the window trough should be capped with aluminum coil stock or vinyl (or equivalent), which is first back caulked and then nailed into place.
- ◆ Scrub all surfaces thoroughly with a cleaning agent suitable for leaded dust removal, and rinse with clean water. Any necessary repairs to the weight and pulley system should be made at this time. Reinstall the sash with a new stop bead. Wet scrap any additional paint that was loosened by the hammering. All surfaces should be vacuumed one more time. The new stop bead should be primed and painted.
- ◆ Cleanup the worksite in accordance with guidance in Chapter 14. Generally, the impermeable protective sheeting used to protect the surrounding area should be misted, folded with the dirty surface inside, and placed in a heavy duty plastic bag or wrapped with heavy duty polyethylene sheeting. The bag or package should be sealed and labeled to identify the contents for later disposal. Floor surfaces should be vacuumed beneath the protective sheeting and several feet around the sheeting on each side. Other horizontal surfaces in the containment area should also be vacuumed. The floor and other horizontal surfaces should be wet washed with the cleaning solution and rinsed with clean water. Vacuum any rough horizontal surfaces a final time.
- ◆ For further protection install replacement window channels or slides. Aluminum, vinyl, and polyvinyl chloride (PVC) plastic channels are available (see Figure 11.9). It should be noted, however, that these “jamb liners,” as they are sometimes called, have a very high failure rate. The Evaluation of the HUD Lead-Based Paint Hazard Control Grant Program found that 46 percent of the jamb liners failed three years after installation. (NCHH, 2004) Over half of the failures were attributed to inadequate installation, and 29 percent failed because they were damaged.
- ◆ In this case, both the stop and parting beads should be removed, both sashes taken out, the chain and pulley system disconnected, and the pulleys removed. The old sashes should be planed (with HEPA exhaust), re-caulked, primed, and painted. All other surfaces should receive the same treatment as described above. The jambs should be repainted, the window channels installed with the old sashes, and a new interior stop bead.

- ◆ Covering painted surfaces with coil stock or channel systems may be considered by some State or tribal lead certification agencies to be an enclosure abatement measure combined with interim controls since the whole window system is not enclosed. It should be noted that this approach provides a great deal of flexibility to the property owner. In many cases, it will permit the most cost-effective strategy to be used.
- ◆ If windows are badly deteriorated, it may be more cost effective to replace them, particularly in young children's bedrooms, or in rooms in which young children frequently play.

2. Door Systems

Doors present a problem when the doorframe becomes misaligned due to settlement, or when multiple coats of paint reduce frame clearance to the point where the door sticks, rubs, or even chips paint on the door or doorstop when opened and closed (see Figure 11.15). The simplest approach is to re-hang the door so that it no longer rubs against the doorjamb.



FIGURE 11.15 Stabilizing paint on doors: Wet planing (left) and wet sanding (right) deteriorated paint can create significant amounts of dust.

To accomplish this, prepare the work area in accordance with guidance provided in Chapter 8. Heavily painted stops on jambs can be misted, scored with a knife, and pried loose. The stop should be wrapped in plastic and sealed with tape for disposal. Friction points on the door should be noted. Hinge pins should be removed and the door carefully planed (preferably outside the unit) to eliminate the friction points. (Note: Planing of doors will generate considerable leaded dust and paint chip contamination and may be more easily completed offsite in a controlled environment.) A new stop, if necessary, should be installed and any paint loosened by the hammering should be wet scraped. The new stop and planed areas should be primed, and all surfaces repainted, as described in Section II of this chapter. Cleanup the worksite in accordance with guidance provided in Chapter 14.

3. Stair Systems

There are a number of treatments that will control lead hazards on stairs. Installation of rubber tread guards will lessen or eliminate friction on the tread (see Figures 11.16 and 11.17). The tread guards should cover the entire width of the stairs. Do not use precut tread guards if they do not cover the entire width of the stair.

Covering the treads *and* risers with new carpeting can be useful in lessening friction and impact. It is important that carpeting be securely installed and cover the entire width of the stairs, since loose fitting carpeting can cause abrasion and subsequent dust releases. However, since carpeting must be vacuumed thoroughly and frequently to prevent the accumulation of deeply embedded dust lead, installation of a hard, cleanable surface is generally preferable to carpet.

4. Chewable Surfaces

The most common chewable surface is a protruding interior window sill, although other components have been chewed by children. The objective in treating such surfaces is to either remove the lead-based paint (using one of the paint removal methods described in Chapter 12) or cover the component with a puncture resistant material. For the latter approach, two options are aluminum coil stock or a hard, puncture resistant encapsulant. Install coil stock as described above for window troughs. Install encapsulants as described in Chapter 13.



FIGURE 11.16 Before and after stair treatments.

5. Baseboards and Outside Wall Corners

Damage to baseboards subject to frequent impact can be lessened by installing shoe molding at the bottom of the baseboard (see Figure 11.18). This relatively inexpensive treatment provides a barrier that prevents chair and table legs from actually striking the lead-based painted surface.

If there is existing shoe molding that has been damaged beyond repair, it should be removed by misting the surface, scoring with a razor, and prying the molding loose. The removed molding should be wrapped in plastic and sealed with tape for disposal. Since the baseboard is not necessarily removed, installation of new molding is a combined abatement/interim control measure. New shoe molding should then be back-caulked.

Impact or abrasion of outside corners of walls can be reduced by the installation of a wooden or plastic corner bead (see Figure 11.19).

A rubber tread with metal nosing works well. Rubber nosing that fits snugly on the nose may work if the stairs are not used very often.

- ◆ Enclose risers with thin plywood (like luan plywood) or some other hard material. Whatever you use must fit snugly.
- ◆ Back caulk the edges of treads. Place them and nail or screw them down. Screw or nail the metal nosing on.

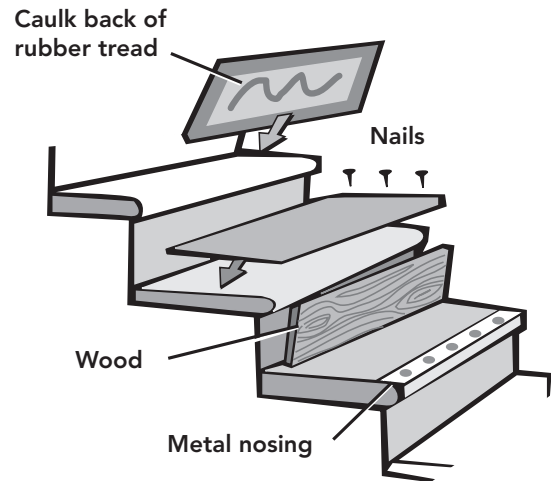


FIGURE 11.17 Covering Stairs with Tread Guards.

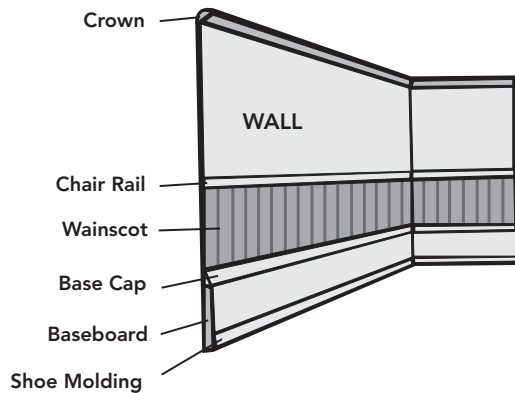


Figure 11.18 Shoe Molding Is an Acceptable Impact Surface Treatment for Baseboards



FIGURE 11.19 Corner Bead Coverings Can Be Used on Outside Corners of Walls.

6. Drawers and Cabinets

Drawers and cabinets coated with lead-based paint present a potential risk when doors or drawer facings do not fit properly. This is especially important when the cabinet or drawer is used for storing food, eating utensils, or bathroom articles, such as toothbrushes. Cabinet doors can be carefully removed and discarded, or can be stripped offsite and planed where necessary to fit properly, and repainted. These activities should only be performed after all articles are removed from the cabinet and the immediate area is contained. The exterior and interior of the cabinets should be thoroughly cleaned before articles are returned.

Drawers can also be removed and stripped offsite. Drawer covers can be planed at impact points and repainted. Installation of rubber or felt bumpers will also reduce impact with the painted surface of the cabinet.

7. Porches, Decks, and Interior Floors

Porches, decks, and interior floors with lead-based paint can be significant generators of paint chips and leaded dust particles through abrasion or impact. At a minimum, the paint should be carefully stabilized and covered with polyurethane or high quality paint. Decks and floors must be smooth enough so that dust can be removed by normal cleaning without special equipment. If funds are available, abatement of floors is strongly recommended, usually through enclosure with new flooring or covering or replacement.

Table 11.2 Sticky Tape Technique for Removing Loose Paint on Impact Surfaces for Owner / Occupants or Residents

1. Place a piece of plastic or paper beneath the area in question.
2. Press a piece of wide sticky tape firmly over the area of loose or chipping paint.
3. Wait a few seconds and then carefully remove the tape, taking the small chips of paint with it.
4. Place the tape in a plastic bag.
5. Carefully fold the piece of plastic or paper that was beneath the area and place it in the bag.
6. Seal the bag and clean the area.
7. Dispose of all waste materials in a secure manner.

V. Dust Removal and Control

How To Do It

1. **Dust lead hazard standards.** If dust wipe samples are collected and analyzed by a laboratory, and the level of lead in dust equals or exceeds the following levels the dust should be removed:
 - ◆ Floors (both hard surfaced and carpeted), 40 µg/ft².
 - ◆ Interior window sills, 250 µg/ft².
 - ◆ Window troughs, 400 µg/ft².
 - Bare floors and window components should also be made smooth and cleanable.
2. **Remove dust lead after controlling other hazards.** Correct any known or suspected lead-based paint hazards before dust removal.
3. **Inspect dust traps.** Visually inspect dust traps, such as radiators and floor grates. If visible dust is found, the component should be cleaned.
4. **Communicate with residents.** Distribute educational materials prepared by EPA or State or local government agencies to residents. The owners of rugs, carpets, drapes and upholstered furnishings are responsible for their care. Recommend to the owners that highly contaminated or badly worn items should be discarded. To discard a rug or carpet, mist the surface with water; seal in plastic sheeting, bags, or containers; and discard properly.
5. **Contain work area for carpet removal.** If contaminated carpets are to be removed, the work area should be contained in accordance with guidance for high dust jobs in Chapter 8.
6. **Vacuum and wet clean hard surfaces.**
 - ◆ **Clean all horizontal surfaces, beginning with vacuuming, with a HEPA vacuum, followed by wet cleaning.** A household cleaning agent (vs. a trisodium phosphate solution) is usually adequate. Test the cleaning solution before using it to determine if it will discolor or damage surfaces to be cleaned.
 - ◆ **Sequence of cleaning.** If cleaning an entire dwelling unit, begin dust removal at the top rear room in the dwelling, working forward and down. (Keeping a similar sequence of room cleanings on each floor may be helpful for assuring rooms are not missed.) When practical, clean dirty areas within a room while taking care to avoid spreading dust. Within rooms, start with the highest surface and work down. Clean windows, other dust traps, and finally the floors.
 - ◆ **Take care in removing vacuum filters and/or bags.** If practicable, remove filters and/or bags from the vacuum offsite (not on the property) in a controlled environment. If filters or bags must be replaced onsite in the middle of the job, take the vacuum unit outside the house if practicable, and replace them – and protect the change area – as described in Section IV.B.1, below.
 - ◆ **Wet clean and rinse.** During wet cleaning, replace rags and mops frequently (at least once per dwelling). Use a three bucket system for floors: one for the cleaning solution, one into which the dirty mop or sponge is squeezed, and the other for rinsing. Change the rinse water at least once in each room. Clean until no surface dust is visible. After cleaning, rinse with clean water and a new rag or cloth. Dispose of dirty water in a toilet.

7. **Clean area rugs.** To clean area rugs, HEPA vacuum the top side with a beater bar or agitator attachment at a rate of 1 minute for each 10 square foot area. Fold the rug in half and vacuum the backing of the exposed half of the rug without using the beater bar at a rate of 1 minute per 10 square feet. Vacuum the exposed floor beneath the rug, the bottom of the rug, and the pad (if there is one), and fold the rug back into its original position. Repeat the process for the other half of the rug. Finally, vacuum the top side again with the beater bar at a rate of at least 2 minutes per 10 square feet. To summarize:
 - ◆ Vacuum the top side for 1 minute per 10 square feet.
 - ◆ Vacuum the bottom for 1 minute per 10 square feet.
 - ◆ Vacuum the top again for a final 2 minutes per 10 square feet.
 - This is a total of 4 minutes for every 10 square feet of rug. Also vacuum the bare floor under the rug and the pad, if present.
8. **Clean wall-to-wall carpet.** For wall-to-wall carpeting that cannot be folded over, HEPA vacuum at a rate no faster than 2 minutes per 10 square feet in a side-to-side direction. Follow this by another pass at the same rate in a direction perpendicular to the direction of the first vacuuming, for a total of 4 minutes per 10 square feet. For wall-to-wall carpeting, it is not feasible to clean the floor underneath the carpeting. To attain an even higher level of cleanliness, steam clean the carpet using a regular commercial cleaning system after performing the HEPA vacuuming.
9. **Clean upholstered furnishings.** To clean other upholstered furnishings, vacuum each surface three to five times. Steam cleaning is generally not recommended because it may damage the fabric. However, newer steam cleaners have a water extraction feature to prevent water damage to fabric. Test a small section of the fabric for color fastness before cleaning the entire surface.
10. **Clean drop ceilings and ductwork when necessary.** Clean drop ceilings or the ductwork for forced air systems only when they are expected to be disturbed. Vacuum and wet clean air vents or registers. Replace air filters in the forced air systems at the time of cleaning.
11. **Conduct clearance dust wipe sampling on carpets, rugs or furnishings that were cleaned to determine if the cleaning was effective.** Have a certified lead-based paint inspector, risk assessor, or sampling technician conduct a clearance examination (see The Basic Steps Common to Most Jobs – How to Do It, item 10, on clearance, above, Chapter 15). Repeat cleaning, if necessary.
12. **Ongoing lead-safe maintenance.** Perform ongoing lead-safe maintenance in accordance with guidance in Chapter 6. If required by regulation or the property owner or manager's preference, conduct reevaluations every two years in accordance with guidance in Section VII of Chapter 5.

A. Introduction

Dust removal is a type of interim control that involves an initial treatment followed by clearance and re-cleaning as needed. This section provides information on when the removal of leaded dust alone is an appropriate interim control and how to accomplish it. Some dust removal will *always* be an element of interim control measures, either as a stand-alone treatment or as part of cleanup following other work.

1. Sources and Locations of Leaded Dust

Lead in settled house dust is the main source of lead exposure for young children. Leaded dust can come from deteriorating lead-based paint on interior and exterior surfaces, abrasion of lead-based paint on friction and impact surfaces, and the disturbance of lead-based paint during maintenance, renovation, or remodeling activities. Leaded dust can also originate from exterior soil or dust. Sources of lead-contaminated soil include weathering or scraping of exterior lead-based paint, past use of lead additives in gasoline, industrial point sources, and demolition and paint removal from buildings and steel structures. Lead-contaminated soil and exterior dust can be tracked inside by humans and pets or carried indoors by wind. Leaded dust can be produced by activities related to hobbies and can be carried home on the clothing of workers exposed to lead. Table 11.3 provides a summary of potential sources of lead in settled house dust.

Table 11.3 Potential Sources of Lead Containing House Dust.

Source	Process That Contributes to Lead in House Dust	Key Sites
Interior lead-based paint	Deteriorating paint. Friction/abrasion.	All surfaces. Windows, doors, stairs, floors, carpets, rugs, window coverings (drapes and curtains), mats, and upholstered furnishings.
	Impact.	Door systems, openings, baseboards, corner edges, chair rails, and stair risers.
	Water damage.	Walls, trim, windows, and ceilings
	Planned disturbances: (maintenance activities, repainting, remodeling, abatement).	All surfaces coated with lead-based paint.
Exterior lead-based paint	Tracking (by humans and pets) and blowing of leaded dust from weathered, chalked, or deteriorated exterior lead-based paint; also direct contact with such paint.	All exterior lead-based painted components, including porches and window sills.
	Demolition and other disturbances of lead-based paint on buildings and nearby steel structures.	Exposed soil, sandboxes, sidewalks, and window troughs.
Soil and exterior dust	Tracking (by humans and pets) and blowing of exterior soil/dirt contaminated with lead from deteriorating exterior lead-based paint; past deposition of lead in gasoline.	Exposed soil, sandboxes, sidewalks, streets, and window troughs.
Point sources	Releases from lead related industries (i.e., smelters, battery recycling, incinerators).	Location of point sources.
Hobby activities	Cutting, molding, and melting of lead for bullets, fishing sinkers, toys, and joining stained glass. Use of lead containing glazes and paints. Restoration of lead-based painted items.	Rooms in which hobbies are pursued.
Occupational sources	Transport of lead-contaminated dust from the job to home on clothing, tools, hair, and car or truck.	Vehicles, laundry rooms, changing areas, furniture, and entryway rugs.

Leaded dust can be found on surfaces and in crevices throughout a dwelling. Certain surfaces can act as major reservoirs of lead-contaminated dust, including window troughs, worn floors, carpets, and upholstered furnishings (see Table 11.4). Cleaning carpets, upholstered items, and worn floor surfaces can be difficult due to embedded dust and dirt. Furthermore, lead-contaminated dust can rapidly re-accumulate on household surfaces following dust removal if the conditions contributing to the contamination are not controlled (Tohn, 2002; Lanphear, 2000).

Table 11.4 Major Dust Reservoirs and Potential Dust Traps.

Interior		Exterior
Window sills	Upholstered furnishings	Porch systems
Floors/steps	Window coverings	Window troughs
Cracks and crevices	Radiators	Steps
Carpets and rugs	Grates and registers	Exposed soil
Mats	Heating, ventilation, air conditioning filters	Sandboxes

Lead-contaminated dust in carpets and rugs, window coverings (drapes and curtains), mats, and upholstered furnishings is a hazard whether those items are supplied by the owner of the dwelling or by residents. Owners of rental units are responsible for cleaning such items or removing and replacing them only if they belong to the owners. However, the owner should try to provide residents with educational material furnished by a government agency or a qualified lead poisoning prevention organization. Such material should include a warning that carpets and rugs, window coverings, mats, and upholstered furnishings may contain dangerous levels of leaded dust and that those items should be thoroughly cleaned or preferably removed and replaced if they are found to be contaminated.

2. Removing Leaded Dust From a Dwelling

Both large, visible dust particles, and small particles not visible to the naked eye, need to be removed (see Figure 11.13).

A combination of vacuuming and wet cleaning is recommended for leaded dust removal. Use of a HEPA vacuum is preferred. Wet cleaning is conducted with a solution of ordinary household detergent. Trisodium phosphate detergent is banned in many states because of potential environmental impacts, so it is not recommended. Even with special equipment

and procedures, leaded dust can be difficult to remove from dust traps, carpets, non-smooth surfaces, and surfaces abated by paint removal methods such as caustic chemicals (Ewers, 1994; Farfel and Chisolm, 1991; Farfel and Chisolm, 1987b).

Workers and residents removing leaded dust should not spread lead from one household surface to another (cross contamination). Avoiding cross contamination requires special knowledge, equipment, procedures, and precautions to protect residents, workers, and the environment. Enhanced routine cleaning procedures, and practices described in this chapter are recommended for use by property owners over ordinary cleaning practices and procedures. This is not to imply that routine housecleaning is totally ineffective. However, in certain cases, routine housecleaning may need to be augmented by the special procedures detailed in this chapter, since smooth surfaces are easier to clean (see Figure 11.20).



FIGURE 11.20 Turning a Window Sill and Trough Into a Smooth and Cleanable Surface. Window pre-treatment (left) and post-treatment (right).

The cleaning protocol contained in this chapter is different from that used following lead hazard controls and other paint disturbing work, which is described in Chapter 14. The main difference is that only horizontal surfaces (and vertical surfaces undergoing paint stabilization, as explained in Section II of this chapter) are usually cleaned for dust removal. For cleanup following lead hazard control, and other paint disturbing work, walls and horizontal surfaces are cleaned following high dust jobs.

3. Creating Cleanable Surfaces and Determining Whether Dust Removal Alone Is Adequate

A risk assessment is recommended to determine whether the removal of leaded dust alone is an appropriate interim control, or whether other interim controls are needed in addition to dust removal. If no lead-based paint inspection or risk assessment has been performed, the property owner should presume that lead-based paint is present on all painted surfaces and that all horizontal surfaces have excessive dust lead levels.

The rest of this section will describe how risk assessors and owners should check floors and floor coverings to plan for dust removal activities.

- ◆ **Check condition of floors.** Smooth and intact floor surfaces, such as vinyl or linoleum sheet goods that still have a smooth finish and wooden floors that have a good finish of sealant (e.g., polyurethane or deck paint) can be effectively cleaned. If a floor surface is not smooth or intact, it will require the application of an appropriate sealer or covering and/or repair in order to make it smooth and cleanable. Examples of non-smooth floor surfaces include floor coverings with worn areas or tears; wood floors with gaps, cracks, splinters, and areas with no sealant coating; unsealed concrete floors; and replacement flooring with no finish treatment (e.g., plywood).
- ◆ **Check carpets, rugs, entryways, and mats.** If possible, small rugs and mats should be machine washed. Wall-to-wall carpets and large area rugs in fair to good condition can be cleaned, or removed and discarded, or replaced (see section on carpets/rugs below). Consider discarding rugs, carpets, and mats that are at the end of their useful lives, since cleaning may not be effective (see below for precautions on removal of carpets) (Ewers, 1994; CH2MHILL, 1991).
- ◆ **Check for other potential dust traps.** In addition to carpets, rugs, and mats, other potential dust traps include radiators, floor grates and registers, drapes, blinds, and upholstered furnishings. These items should be included in the plan for dust removal. In rental properties some of these items may not belong to the building owner. Owners are responsible for the items they own, while residents are responsible for their own property. However, it may be in everyone's best interest to include all of these items in the dust removal plan.

4. Planning and Preparations

Once it has been determined that dust removal is an appropriate approach, the owner should determine if the dwelling unit will be occupied or vacant while the dust removal is occurring. Dust removal work may be performed by contractors, maintenance staff, or homeowners. Individuals performing the work should be properly equipped and trained in dust removal.

If dwelling units are occupied, the owner should coordinate with residents to ensure that the roles of all involved in the process are clear. The job should be organized so that dust removal work is performed in 1 day to minimize inconvenience to residents. Additional personnel and equipment may be required to perform simultaneous work in multiple rooms.

Role of residents. See Section I.D, above, regarding preventive measures that can be performed by residents.

Owners should provide residents with educational materials prepared by public agencies that indicate how residents can help in removing leaded dust. The materials should indicate that residents should perform the following tasks regarding property the residents own before the professional dust removal occurs:

- ◆ Wet wash all cleanable toys the residents own.
- ◆ Store all loose personal belongings that need not be professionally cleaned in boxes, closets, or drawers to provide easy access to floors and other surfaces during dust removal.
- ◆ Remove drapes and curtains the residents own and collect any washable area rugs the residents own for cleaning. Clean or arrange for cleaning of these items and store them in sealed plastic bags, or have the cleaners keep them until after the housing owner's lead dust cleaning work is completed.

- ◆ Wash blankets known to have been unprotected during renovation or remodeling activity that disturbed lead-based paint.
- ◆ Wash or dust un-upholstered furniture the residents own using disposable cloths and spray polish.
- ◆ Change filters in heating and air conditioning units, except where routinely performed by the property manager.

5. Responsibilities of Owners

Owners should perform the following tasks prior to dust removal:

- ◆ Attempt to schedule dust removal when the dwelling is vacant (such as during unit turnover).
- ◆ If the unit will be occupied, notify residents of the date dust removal will occur.
- ◆ Provide a written notice/flyer from the local health agency with information on resident responsibilities for preparation and cleaning.
- ◆ Provide for the safety of occupants.
- ◆ Arrange for dust removal of wood or metal components of windows, built in shelving, radiators, floors, porches, owner supplied carpets and rugs, window coverings, mats, upholstered furnishings, and other dust traps.
- ◆ Provide and install cleanable “walk-off” mats at interior entryways. This will help residents control exterior leaded dust that may be tracked into the home (Roberts, 1991).
- ◆ Ensure that dust removal contractors comply with contract specifications. Large multi-family contracts may require an onsite monitor.
- ◆ Obtain written authorization from residents for dust removal where legal authority does not exist for such activity.
- ◆ Arrange for clearance examination.

6. Responsibilities of Contractors

Contractors or maintenance staff should perform the following tasks prior to and during dust removal (City of Toronto, 1990):

- ◆ Coordinate with residents and owners or managers of property.
- ◆ Cooperate with the client’s independent, onsite inspector or risk assessor or other authorized project monitor who may be present on large, multi-family dust removal projects.
- ◆ Perform work according to contract/work specifications. In the case where the owner’s maintenance staff are performing the work, the owner is responsible for the following (otherwise the contractor is responsible).

- ◆ Ensuring that workers are properly trained and protected (see Chapter 9).
- ◆ Providing all safety and special cleaning equipment and supplies.
- ◆ Taking precautions to minimize damage to residents' belongings.
- ◆ Moving major furnishings within rooms to facilitate thorough cleaning.
- ◆ Responding to residents' questions, complaints, and concerns.

B. Methods of Dust Removal

The objective of any dust removal strategy is to provide a dwelling unit or common area in which the dust lead levels on all horizontal surfaces are less than the clearance levels. Any cleaning method carried out by a property owner is satisfactory if it meets this performance standard and if workers and occupants are fully protected. The procedures in the following pages describe how best to meet that performance standard.

The dust removal strategy presented in this section focuses on horizontal surfaces and dust traps that have accumulations of surface dust and embedded dust. Contractors and owners must use judgment in determining whether walls should be washed. Embedded dust is dust that is trapped within a fiber matrix (such as carpeting), in cracks and crevices (of wooden floors), under carpets, on greasy surfaces, or ground into surfaces. A combination of vacuuming – a HEPA vacuum is required – and wet cleaning is recommended to remove both surface and embedded leaded dust from household surfaces. For upholstered furnishings vacuuming alone is generally recommended.

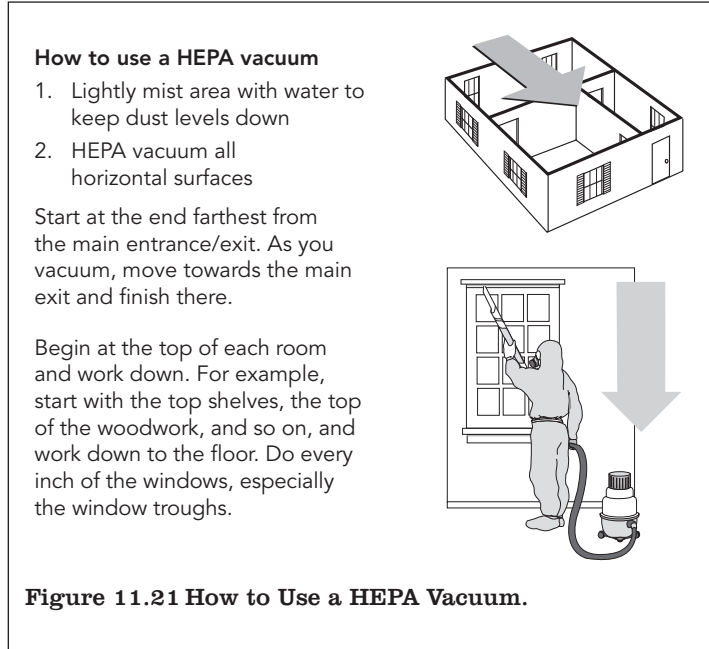
1. Cleaning Hard Surfaces

The standard dust removal procedure for hard surfaces and components (e.g., hardwood floors and window components) is HEPA vacuuming followed by wet cleaning. One study found that vacuuming hard surfaces at a rate slower than 1 minute per square meter (approximately 10 square feet) did not remove substantially more leaded dust from hard surfaces than faster methods (Ewers, 1994). Therefore, no speed or time restrictions are necessary for hard surfaces (although such restrictions are appropriate for carpeted surfaces, as detailed below). On hard surfaces vacuums should be passed over the entire surface with overlapping strokes using normal speed.

General all-purpose household cleaners have been found to be effective for wet cleaning. Although lead specific cleaners may also be effective, one study found them to be no more effective than all purpose cleaners (Lewis et al. 2006). Trisodium phosphate is not recommended. Not only has it been banned in some areas because of negative effects on the ecology of aquatic systems but research indicates that phosphate content is not associated with effectiveness in removing lead-contaminated dust from residential surfaces (EPA, 1997a; EPA, 1998; Lewis et al 2006). Research also indicates that the effort put into the cleaning, i.e., the amount of pressure applied to the surface and the thoroughness of the cleaning, may be more important than the choice of cleaning agent (EPA, 1997a). Whenever a wet cleaner is used, a small area of the surface should be tested to make sure that it does not damage the surface or its coloring. If so, another wet cleaner should be used.

General work practices

- ◆ Clean from top to bottom. HEPA vacuum before wet cleaning. On multistory dwellings, start at the top level in the rear room and work in one direction toward the front. Then repeat the process on the remaining floors in sequence. Within a room, start with the highest horizontal surfaces and work down. This will typically result in the following cleaning sequence: tops of window heads, tops of sashes, mullions, and interior and exterior window sills and troughs. Clean dust traps such as radiators, followed by baseboards, and finally floors, vents/registers, and horizontal components of the ventilation ducts that can be easily reached. When practical, work from clean areas to dirty areas to minimize the spread of leaded dust to clean areas. It is usually not necessary to clean walls and ceilings for dust removal unless those surfaces have undergone paint removal or paint stabilization, or substantial leaded dust has been created in the course of other work.
- ◆ When vacuuming, use crevice and brush tools where appropriate.
- ◆ If possible, place the HEPA vacuum unit on a smooth, hard surface that has been cleaned, or on clean, durable, polyethylene sheeting rather than on a carpet. Vacuum exhaust, even on HEPA vacuums, can disperse dust when the exhaust airstream disturbs settled dust on a surface. A HEPA vacuum that exhausts air from the top or side, rather than the bottom, helps to minimize dust dispersal. (see Figure 11.21).
- ◆ Use disposable cleaning cloths or sponges. Be prepared to dispose of them during the cleaning process and replace them with new ones.
- ◆ When cleaning household surfaces other than floors, the cleaning solution may be mixed in a plastic jug and poured directly onto sponges or cloths (EPA, 1992a). This procedure is designed to minimize the contamination of the cleaning solution with leaded dust. Frequently rinse the sponge/cloth in a bucket of clean water.
- ◆ For floors, a three bucket system is recommended to minimize the potential for spreading leaded dust from one location to another. The cleaning solution should be mixed in one bucket. Dirty water is squeezed into a second bucket. A third bucket should contain rinse water for the mop head. Frequently, at least once per room, change the rinse water in the bucket. Use a string mop



if possible. A sponge mop is likely to just push the dirt in front of it. A final cosmetic rinse is recommended using clean water.

- ◆ Clean until surface dust is no longer visible. After cleaning a window sill or a floor, rinse with clean water using a new sponge or cloth.
- ◆ To make a cleaning solution, mix with water according to the manufacturer's instructions for recommended concentrations. When using the cleaner, wear gloves and eye protection gear. Follow all manufacturer's instructions and precautions.
- ◆ Whenever possible, clean floors and pads underneath rugs and carpets.
- ◆ For dust removal projects in multi-family housing, a truck-mounted vacuum unit with a HEPA filter exhaust is preferable. Since the exhaust stream is located outside the dwelling it is not likely to disturb dust inside the dwelling.
- ◆ In a controlled environment capable of capturing any dust released by the procedure, remove and dispose of vacuum cleaner bags and filters offsite, according to the manufacturer's instructions. If the filters and/or bags need to be changed onsite in the middle of the job, take the vacuum unit outside the house if practicable. (see Figure 11.22).
 - If filters and/or bags must be replaced outside the building, but still on the property:
 - ◆ place the vacuum on a sheet of plastic,
 - ◆ replace the filters and/or bags,
 - ◆ wet clean the outside of the vacuum,
 - ◆ vacuum the plastic,
 - ◆ pull up the plastic,
 - ◆ vacuum the immediate area, and
 - ◆ dispose of the plastic.
 - If filters and/or bags must be replaced inside the building:
 - ◆ place the vacuum on a sheet of plastic,
 - ◆ replace the filters and/or bags,
 - ◆ wet clean the outside of the vacuum,
 - ◆ vacuum the plastic,
 - ◆ pull up the plastic,
 - ◆ vacuum and wet clean the immediate floor area, and
 - ◆ dispose of the plastic.



a) Remove the HEPA Vacuum Filters and Disassemble the Vacuum



b) Disconnect Vacuum Bag From Hose Inlet



c) Remove Bag with a Plastic Sheet Underneath



d) Tape Vacuum Bag Closed and Put Inside Plastic Trash Bag



e) Wash/Replace Coarse Prefilters if Necessary



f) Remove & Replace HEPA Filter Assembly.

Figure 11.22 Changing HEPA vacuum filter.

2. Removal or Cleaning of Carpets

Carpeting and area rugs (all referred to here as carpets) can be major traps and reservoirs of leaded dust. Dust embedded in the fibers of carpets and rugs is not easily removed by cleaning.

The two methods of cleaning carpets that are generally available for residential settings are dry vacuuming and hot water extraction vacuuming (which can deliver detergents as well as heated water). Based on limited research, it appears that dry vacuuming has greater efficiency in removing embedded dust particles from carpets than hot water extraction with detergents (Lewis, 2002; Brown, 1982; CH2MHILL, 1991). Wet methods may be a useful supplement to dry vacuuming, especially if the dust is oily, as perhaps from kitchen aerosols.

The fundamental difficulty in cleaning carpets with deeply embedded dust lead is that (1) it is often difficult to remove a high percentage of the deep dust, yet; (2) unless most of the deep dust is removed, periodic vacuuming is likely to draw contaminated dust to the surface, where it is available for exposure to young children. Research indicates that dust lead hazards can be removed from most carpets by sustained vacuuming. The cost of removal from some carpets may exceed the cost of replacement (Ewers, 1994; Roberts, 2004; Roberts, 1999).

Deciding whether to clean or dispose of carpets. The first step in carpet dust removal is to decide if the carpet is going to be cleaned onsite, removed for disposal, or removed for

professional offsite cleaning. It may be preferable to dispose of carpets that are in poor condition or those known to be highly contaminated with lead. In fact it may be more costly to clean a lead-contaminated carpet or rug than to replace it.

Research has found that the following factors are associated with difficulty of dust removal from carpets and rugs:

- ◆ **The height and density of the pile.** Shag rugs are most difficult because the longer fibers retain dust particles (Wang, 1995; EPA, 1997c). High density, plush carpets are more difficult than low density, low pile carpets (Lewis, 2002).
- ◆ **Wear.** Worn carpeting may have more tangled fibers that make it difficult for dislodged dust particles to travel to the vacuum nozzle (Lewis, 2002). New rugs that have been recently soiled are easier to clean.
- ◆ **High dust lead loading.** Very high dust lead loadings are associated with lower collection efficiency (Wang, 1995; EPA, 1997c).
- ◆ **Duration of contamination.** The longer the duration of contamination, the more likely the dust particles are deeply embedded.
- ◆ **Low relative humidity.** Low humidity may intensify the electrostatic field between the dust particle and the fiber, making it more difficult to dislodge the particle (EPA, 1997c; Wang, 1995).

Removal of carpets. When a carpet or rug is going to be removed from a dwelling for either disposal, or offsite cleaning, the following procedure is recommended to minimize the exposure of workers and residents to leaded dust:

Mist the entire surface of the carpet to keep dust from spreading. Carefully roll up the carpet along with any padding. Wrap the carpet in a sheet of plastic, seal it with tape, and remove it from the dwelling.

If the padding is not going to be removed, clean it using the lead hazard control procedures for cleaning an area rug (see below). Note that the cost of replacing padding is often less than the cost of cleaning it.

Removal of a wall-to-wall carpet may generate significant amounts of airborne lead-contaminated dust, even more than removal of a area rug. Worksite preparation should be similar to a high dust job (see Chapter 8), although, of course, protective sheeting should not be placed on the carpet that is being removed. Furniture that cannot be moved from the room should be covered with impermeable protective sheeting. Removal of an area rug generates less dust if done according to the guidance in the previous paragraph, so it can be handled as a low dust job. Always vacuum the floor after removing the carpet so leaded dust is not tracked to other parts of the dwelling. (The floors may be wet washed after vacuuming if they are made of a material that will not be damaged by large amounts of water on them; they should be vacuumed again after they are dry.)

Selecting a vacuum. Vacuum cleaners used for cleaning up dust as a lead hazard control measure must be high efficiency particulate air (HEPA) vacuums if the work is covered by OSHA's Lead in Construction rule, EPA's RRP Rule, or HUD's LSHR. (See Appendix 6, and, in particular, 29 CFR 1926.62(h)(4), 40 CFR 745.85(b)(2)(A) and (B), and 24 CFR 35.145 and 150(b), respectively.)

HEPA vacuums differ from conventional vacuums in that they contain high-efficiency filters that are capable of trapping extremely small, micron-sized particles. These filters can remove particles of 0.3 microns or greater from air at 99.97 percent efficiency or greater. (A micron is 1 millionth of a meter, or about 0.00004 of an inch.)

(Some vacuums are equipped with an ultra-low penetration air (ULPA) filter that is capable of filtering out particles of 0.13 microns or greater at 99.9995 percent efficiency. However, these ULPA filters are slightly more expensive, and may be less available than HEPA filters.)

The characteristics of a vacuum that are associated with effectiveness of cleaning carpets are:

- ◆ **Particle lifting velocity.** This appears to be a function of the design of the nozzle as well as the suction (static pressure in the nozzle). High suction alone does not predict efficient dust lead recovery. Vacuum velocity may be more important with shag carpets than with other types of pile. (Wang, 1995; Lewis, 2002; EPA, 1997c).
- ◆ **An effective agitator bar, or beater bar.** A power driven agitator helps dislodge dust particles and can significantly increase dust collection efficiency (Roberts, 1991; CMHC, 1992; Ewers, 1994; Lewis, 2002; EPA, 1997c; CH2MHILL, 1991).
- ◆ **Filters and/or bags that capture the dust particles.** HEPA filters are preferred from a technical perspective, in addition to being required by regulations in most cases (see above), because they are likely to catch very small particles that may include allergens as well as lead. However, recent research indicates that very little dust escapes through the exhaust of good-quality non-HEPA vacuums (EPA, 1995c; Rich, 2002; Yiin, 2002; California Department of Health Services, 2004). Also, some manufacturers of conventional vacuums offer filtration systems that capture smaller particles than do traditional systems. Therefore, if a HEPA vacuum is not required by regulation and is not available, a good-quality non-HEPA vacuum can be used effectively, especially if it is fitted with a "HEPA-type" or "Allergy" filter bag (EPA, 2000a).
- ◆ **Durability.** Removal of deep dust by vacuuming may take hours, depending on the size of the carpet and its condition. Continual, weekly vacuuming is advised to maintain a nonhazardous surface. Therefore, it is important to have a vacuum that will withstand frequent use and continue to be effective in dust collection.

One study concluded that a vacuum to be used for deep dust removal "should be a high quality, durable, traditional upright (with beater bar), two motor upright (with beater bar), or two motor canister (with powered head)" and that a HEPA filter is advisable (Lewis, 2002). Another researcher has found that a vacuum fitted with a dirt sensor is very useful. The sensor measures the amount of dust being picked up and shows when no more dust or dirt is being collected (Roberts, 1999; Roberts, 2004).

Duration of vacuuming. The vacuuming time required to remove enough deep dust from old carpets to assure that the surface lead loading will be reduced varies with the factors described above under "Deciding whether to clean or dispose of carpets." Reported times have varied from 2 to 85 minutes per square meter (10 sq. ft.) (Roberts, 2002). Intensive vacuuming is necessary to remove embedded dust from old carpets (see Table 11.5).

Table 11.5 Rug Cleaning Steps and Approximate Time Per 10 Square Feet.

Step	Description	Time/10 ft ²
1	HEPA vacuum pile side of rug with beater bar at a rate no faster than 1 minute for every 10 square feet.	60 seconds
2	Fold rug in half and HEPA vacuum bottom of rug without beater bar at a rate no faster than 1 minute per 10 square feet for traditional rugs, or normal speed for manufactured carpeting with plastic backing.	60 seconds for traditional rugs, or Approximately 10-30 seconds for manufactured carpeting with plastic backing.
3	HEPA vacuum bare floor and any padding (no rate restriction or beater bar).	Approximately 10–60 seconds
4	Fold other half of rug over and repeat steps 2 and 3 (no rate restriction and no beater bar).	Approximately 10–140 seconds
5	Fold rug back over so it is in its original position.	Approximately 10–30 seconds
6	HEPA vacuum top side of rug a final time with the beater bar. The rate is no faster than 2 minutes per 10 square feet.	120 seconds
	Total Approximate Time	4.0–8.0 minutes

Cleaning area rugs. If cleaning of area rugs is done onsite, the following steps are recommended:

- ◆ First, vacuum the pile side (the top side) with a vacuum equipped with a beater bar, or agitator attachment, on the vacuum head at a rate *no faster than* 1 minute for every 10 square feet.
- ◆ Fold the rug in half, exposing the backing of half of the rug. The backing of the rug should be vacuumed without using the beater bar attachment (City of Toronto, 1990) at a rate of 1 minute per 10 square feet.
- ◆ Vacuum the exposed pad under the rug, if present, at normal speed and fold back over the rug.
- ◆ Vacuum the exposed floor beneath the rug at normal speed, and unfold the pad and rug.
- ◆ Fold the rug in half again, exposing the backing of the other half of the carpet, and repeat the vacuuming of the bottom of the rug, the pad, and the floor underneath.
- ◆ Unfold the pad and rug.
- ◆ Vacuum the pile side of the rug again using the beater bar attachment. Vacuum at a rate no faster than 2 minutes per 10 square feet.

Consideration should be given to a final cleaning step consisting of a steam cleaning of the pile side of the rug. Steam cleaning can remove additional, but limited, amounts of lead from

rugs (CH2MHILL, 1991). This cleaning can be done by the contractor or owner using commercially available equipment. For multi-family buildings consideration should be given to the use of truck-mounted cleaning equipment since it may be significantly more powerful than typical rental equipment for residential use.

Cleaning wall-to-wall carpeting.

For cleaning wall-to-wall carpeting (see Figure 11.23), the following procedure is recommended:

Vacuum carpeting with a vacuum equipped with a beater bar or agitator attachment on the vacuum head. The beater bar helps to dislodge embedded dust. The total vacuuming time recommended is at least 4 minutes per 10 square feet of carpeting (Ewers et al., 1994), divided into two segments of at least 2 minutes for each 10 square feet. The two vacuuming segments are performed in perpendicular directions. For example, the first segment may be done in an east-west direction, while the second is done in a north-south direction.

The provisions regarding steam cleaning and suitability of general all-purpose household cleaners discussed in Section V.B.1, above, apply to wall-to-wall carpeting.

3. Cleaning Upholstered Furniture

The first step in dealing with upholstered furnishings is to determine if the item is going to be discarded or cleaned. It may be preferable to dispose of items that are in poor condition or known to be highly contaminated with lead.

The recommended dust removal procedure for upholstered furniture is vacuuming. Upholstery surfaces should be vacuumed with three to five passes over each surface at a total rate of 2 minutes per 10 square feet. Steam cleaning, and other wet cleaning procedures are generally not recommended because they may damage fabrics. However, newer steam cleaners have a water extraction feature to prevent water damage to fabric. If wet cleaning is desired, test a small section of the fabric for color fastness before cleaning the entire surface.

Cloth throw covers, slipcovers, or fitted vinyl covers should be provided for all cleaned, upholstered items. This is particularly important for items at the end of their useful lives that would not hold up well under an aggressive vacuuming. A cloth cover material that can be easily removed and washed should be selected.

4. Forced Air Systems and Drop Ceilings

If the ceilings or forced air systems contain leaded dust, they may present a hazard to maintenance or renovation workers who access them (City of Toronto, 1990).



Figure 11.23 Carpet with debris and after cleaning.

Where possible, return and supply air vent registers that can be easily removed should be taken out, vacuumed, and wet cleaned (see Figure 11.24 and 11.25). If the vent registers are sealed to the wall or floor with paint, the edges should be misted and scored to help free the vent register with a minimum of leaded dust generation.

Air vent registers that cannot be easily removed should be vacuumed and wet cleaned in place. The horizontal surfaces in the ductwork that can be easily reached with the vacuum attachment should be cleaned. Water should not be poured down the air duct to clean the vent register; wiping with a damp sponge or mop is adequate. Take care not to cut hands on sharp metal in the vent.

Clean or replace the air filters on heating units and air conditioners with new filters at the time of dust removal. Used filters should be placed in plastic bags and sealed prior to disposal to minimize the potential spread of leaded dust.



Figure 11.24 Air vent before and after cleaning.



a. Vacuum and remove register covers;

b. Vacuum Accessible Parts of Duct Opening

c. Wet wash register covers and replace

Figure 11.25 Clean Air Vent Registers

Leaded dust in non-forced air systems and drop ceilings is not considered a hazard to residents unless major disturbances of the ducts or ceilings are planned, such as repairs or relocations of ducts. When major disturbances of any type of duct or ceiling work are anticipated, cleaning will probably be warranted. This includes instances when forced air systems have the direction of airflow reversed during maintenance.

5. Resident Protection

To facilitate dust removal work and provide protection for occupants, only workers and their supervisors should be in the work area during the dust removal process. This will also help ensure that work can be completed in 1 day. Worksite preparation for low dust jobs is usually adequate for dust removal unless lead-contaminated wall-to-wall carpets are being removed.

In addition, disposable or easily cleaned walk-off mats (door mats) should be placed at entryways to control the tracking of leaded dust into the dwelling (see Figure 11.26).



FIGURE 11.26 Walk-Off Mats

C. Follow-up to Dust Removal

If the clearance area may have had high lead levels before the work and/or has rough horizontal surfaces that may make clearance difficult, the owner or contractor may consider using a pre-clearance screen before calling the clearance examiner. See Section II.J, above, for additional information.

Lead-based paint inspectors, risk assessors, or sampling technicians performing clearance examinations should check to see that all visible dust, debris and residue have been removed from the dwelling before collecting dust samples. (See Chapter 15 for information on clearance.) The clearance dust sampling results will provide a means of checking that lead levels have been reduced by the dust removal work, and will serve as a baseline for comparison to future test results.

In addition to the standard EPA and HUD requirement to perform clearance on carpeted as well as uncarpeted floors, if area rugs have been cleaned as a lead hazard control measure, they, too, should be cleared in order to demonstrate the effectiveness of the cleaning.

Since it has been shown that lead-contaminated dust can re-accumulate on household surfaces following lead-based paint abatement and dust removal alone (Lanphear, 2000; Farfel and Chisolm, 1987b; Jacobs, 1992; Clark, 1993), ongoing lead-safe maintenance and professional reevaluation of the dwelling, resident education, and continued cleaning are important elements of a dust removal plan.

Educational materials prepared by State or local government agencies, or lead poisoning prevention organizations should explain the need for periodic wet cleaning of household surfaces, with particular attention to dust traps and reservoirs, and the importance of the regular disposal of air conditioning and heating unit filters that are routinely cleaned or replaced by the residents. Some owners and municipalities provide cleaning kits to residents to encourage and support their ongoing dust removal efforts. (See Chapter 2 and Section I of this chapter for information on resident education.)

VI. Soil Interim Controls

How To Do It

- 1. Plan Soil Interim Controls.**
 - ◆ Select appropriate soil interim controls, which may include soil alterations, soil surface coverings, land use controls, reduction of soil tracking, or drainage and dust controls.
 - ◆ Prepare a site plan of the yard, showing the soil lead hazard controls. Retain plans for use in ongoing monitoring.
- 2. Contain and dampen dust.** Prepare worksite in accordance with guidance in Chapter 8. Use water to contain dust during the work, and clean play equipment.
- 3. Establish soil alteration.** Impermanent surface coverings include grass (as seed or sod), other ground covers (e.g., ivy), artificial turf, bark, mulch, and gravel. If the area to be controlled is heavily traveled, impermanent surface coverings, such as grass, are not appropriate.
- 4. Put soil surface coverings in place.**
 - ◆ If grass is selected, consult with the local agriculture extension service, or a reputable local nursery, to determine what grasses are appropriate for the locale, soil type, and sun/shade characteristics. Properly prepare the soil prior to seeding or sodding.
 - ◆ If mulch or bark is selected, apply the covering 4-6 inches deep (3 inches is more appropriate for gravel). New bark, gravel, or other materials should not contain more than 200 $\mu\text{g/g}$ of lead, if possible, and never more than 400 $\mu\text{g/g}$.
 - ◆ If live ground covers (including grass) are selected, it is imperative that they are properly watered during the first 3 months and adequately maintained thereafter. Automatic sprinkler systems are appropriate for large properties.
 - ◆ If the soil is in a public recreation area, comply with Consumer Product Safety Commission standards on acceptable surface coverings in play areas.
- 5. Install land use controls.** Land use controls include fencing, warning signs, changes in administrative practices, creation of alternative play areas (such as decking), and thorny bushes.
- 6. Drainage and dust controls.** Control water erosion by proper grading to pitch the slope away from the building and installing drainage channels (drainage channels may need to be fenced or covered if they are accessible). Control wind erosion by periodic watering, windbreaks, or foot traffic controls.
- 7. Reduce dust tracking.** Provide walk-off doormats at all entryways to reduce the tracking of contaminated dust and soil into the dwelling.
- 8. Perform ongoing monitoring and maintenance.** Perform ongoing monitoring and maintenance of soil coverings and land use controls. If ongoing monitoring shows that bare soil remains, or reappears within 12 months of an interim soil control, the interim controls are not effective. Soil abatement should be conducted (see Chapter 12), unless other interim controls can be shown to be effective for the specific site.
- 9. Reevaluation.** If required by regulation or the property owner or manager's preference, conduct reevaluations every two years in accordance with guidance in Section VII of Chapter 5.

A. Definition of Soil Lead Hazards

A soil lead hazard in residential property is bare soil that contains total lead equal to or exceeding:

- ◆ 400 parts per million (or $\mu\text{g/g}$) for play areas frequented by children under 6 years of age, or
- ◆ 1,200 parts per million (or $\mu\text{g/g}$) for other parts of the yard including the dripline/foundation area in non-play areas.

These values are from the federal lead hazard standards rule (at 40 CFR 745.65(c)). State and local standards may vary; if lower, they apply to the housing.

EPA does not provide for a *de minimis* area of bare soil outside the play area that can exceed the 1,200 $\mu\text{g/g}$ standard, such as the 9 square feet per property that HUD had incorporated into its Lead Safe Housing Rule (24 CFR 35.1320(b)(2)(ii)(B)) issued 1½ years before the EPA issued the lead hazard standards rule. EPA noted that it had no analysis or data that relate the amount of bare soil to risk, and the incremental cost of including soil testing in a risk assessment is small. As noted in Chapter 5 of these *Guidelines*,

“However, EPA highly recommends using the HUD Guidelines for risk assessment.... This would avoid declaring very small amounts of soil to be a hazard in the non-play areas of the yard. This would also help target resources by eliminating the need to evaluate soil or respond to contamination or hazards for properties where there is only a small amount of bare soil.”

Once soil sampling establishes that a yard has soil lead hazards, it can be useful to create a map of soil lead concentrations in the yard, such as by using an XRF analyzer that is capable of direct measurement of soil lead concentrations (EPA, 2001a), or by soil sampling and analysis (see Chapter 5, Sections II.C and IV, respectively). This information can be useful for developing a customized interim control plan for the particular yard.

B. Temporary and Permanent Soil Treatments

Interim measures for controlling soil lead hazards include surface coverings with grass, gravel, mulch, wood chips, or similar materials, or land use controls, such as fences, thorny bushes, or decks, for preventing contact with the contaminated soil. These interim controls are designed to temporarily reduce exposure. How long they remain effective depends on many factors, including the durability and maintenance of the cover, amount or degree of foot traffic, and climate.

Soil abatement measures are described in Chapter 12, Section V. If the control measure consists of replacing soil that is a soil-lead hazard (see Section A, above) with soil of acceptable lead levels, or includes installing a permanent cover, such as asphalt or concrete, the method is classified as abatement.

C. Types of Interim Control Measures for Soil

Five types of measures may be used as part of an interim control plan for soil. They are:

- ◆ Measures that alter the contaminated soil.
- ◆ Measures that alter the surface cover.
- ◆ Land use controls.

- ◆ Measures that reduce soil tracking
- ◆ Measures to reduce offsite drainage or dispersal of the contaminated soil.

Each of these activities should be carried out in a manner that prevents further dispersal of the contamination and prevents the area undergoing the interim control treatment from being contaminated in the process. Work practices for soil interim controls are similar to those for soil abatement and are described more fully in Chapter 12, Section V.

1. Soil Alteration

Interim controls usually involve some alteration of the soil. Examples include surface cultivation, additives, or rototilling clean soil into existing soil to assist in establishing ground cover (e.g. grass, ivy). Grading of the soil is sometimes needed to assure proper drainage. Typically surface alteration is not effective enough to be used as the sole interim control measure. Tilling and mixing the soil to a depth of at least 8 inches may be effective. The addition of clean soils and compost can be used to reduce the lead concentration of vegetable garden soils that are only slightly above the recommended maximum 400 ppm lead concentration, however, for highly contaminated garden soils the contaminated soil should be removed and replaced with clean soil or the garden should be relocated.

2. Soil Surface Cover

The most common form of soil interim control is surface covering that creates a barrier between leaded soil and children. Typical materials include bark mulch, pea gravel, crushed stone, grass seeding, sod, other live ground covers (e.g., juniper, shrubs, ivies), and paving stones. Except with installations of grass seed or sod, a water permeable landscape fabric should always be used to create a barrier between the soil and the installed material. Landscape fabric controls for weeds, creates a clear barrier to leaded soil, and visually signals when the installed material needs to be replenished.

The choice of a covering for a particular area depends on the climate, expected use, planned maintenance, and aesthetic preferences. For aesthetic as well as practical reasons, a property owner may choose to improve the surface cover over an entire soil area even though only a portion is bare.

The success of grass and other live ground covers is dependent on proper planting, adequate water and sunlight, regular maintenance, and most importantly, the ability to control the use of the area. In high traffic areas use of grass as an interim control is unlikely to succeed. Where access to an area can be controlled, or where use is expected to be limited, grass and other live ground covers can be successful interim controls. Some ground covers, such as juniper bushes, can also effectively limit traffic through an area. Shade tolerant ground covers such as ivies are better suited than grass for areas that receive little sunlight.

Before using grass or live ground covers as an interim control measure, a property owner should consult with a lawn care professional about soil preparation, appropriate grasses and plants to use, and future maintenance requirements. The county cooperative extension service or a reputable local nursery may be contacted for advice on types of grass or other ground cover to be used in specific geographic areas and for specific soil types, slope, and sunlight conditions. Table 11.6 offers a brief summary of grass types and their suggested uses.

The local office of the U.S. Department of Agriculture's Natural Resources Conservation Service (<http://www.nrcs.usda.gov/wps/portal/nrcs/main/national/home>) may also be able to provide advice about soil conditions in a specific geographic area. An owner of a large property may consider installing a sprinkler system to improve the maintenance effort. In any event some type of hose and sprinkler system should be made available.

An owner should consider whether sod or seeding is more appropriate when planting grass. Both grass seed and sod require restrictions on foot traffic until root systems and stems become established. Newly laid sod requires at least 2 weeks, while grass seed requires 1 to 2 months (Lane Publishing, 1989; Maryland Cooperative Extension, 1994). Sod can be laid during most of the year (as long as the ground is not frozen) and requires less initial care. However, sod is more expensive than seeding and is less likely to develop the deep root systems that will allow the grass to withstand regular wear and tear. It is best to lay sod during the growing season.

At least 3–4 inches of bark, mulch, wood chips or gravel are recommended to serve as a temporary ground covering (see Figure 11.18). If the covering is more than 3 inches thick, water will not reach plantings that may be in the area. Four inches is recommended for play areas. This level of material can be achieved by constructing a raised bed framed with 2" x 6" ACQ (alkaline copper quaternary) pressure-treated lumber. ACQ-treated lumber (or newer composite/non-wood materials) contains no EPA-listed hazardous compounds, whereas chemicals used in traditional pressure-treated lumber include compounds of, in addition to, copper, chromium and arsenic (commonly referred to as CCA-treated lumber), which may leach into the environment. Rock or other edging material may be used instead of lumber, depending on site specific conditions.

Do not use mulch made from recycled building components unless it has been tested and found to contain less than 400 µg/g of lead. EPA requires that replacement soil used in soil abatement contain less than 400 µg/g of lead. If possible, replacement bark, mulch, wood chips, and added soil should contain no more than 200 µg/g of lead, in order to provide a further safety factor.

Bark or other suitable soft material should be used as surface cover for contaminated soil near play equipment. This will offer a degree of protection from injuries that may result from falling. Consumer Product and Safety Commission regulations dealing with acceptable surface coverings in play areas may apply to public areas (CPSC, 1991). Artificial turf can also be used, but may cause drainage problems if it is not permeable.

Rubber cushioning specifically designed for playgrounds can also be used to cover contaminated, bare soil in play areas.

3. Raised Beds and Other Landscaping Options

The installation of raised beds can be an effective control measure in areas with high soil lead levels where grass would not be expected to grow well. They are often well suited for use in the drip zones of homes (i.e., the area extending approximately 3 ft. from the foundation). The beds can be created using 2" x 6" ACQ pressure-treated lumber, using landscape fabric to cover the ground followed by the application of top soil and mulch if the beds will be planted. If the beds are not planted, mulch, woodchips, or gravel can be placed directly over the landscape fabric.

A cost-effective approach to treat bare foot paths is to place stone or concrete stepping stones along the pathway and cover surrounding bare soils with a layer of gravel or mulch.

An option for play areas and picnic areas with contaminated bare soils is to create raised wooden platforms using ACQ pressure-treated lumber. This may be especially appropriate for small yards where relocation of such activities within the yard area is not possible.

4. Land Use Controls

Altering the use pattern of the yard is another common way to control human exposure to bare, contaminated soil. Measures include: fencing, to create a barrier to contaminated soil; planting thorny or dense bushes (see Figure 11.27) to discourage access; decks with lattice added below to restrict access to soil under the deck; relocating play areas to move a play area away from old painted structures, such as a fence or shed, and away from areas with high soil lead levels; warning signs; and educational efforts.

Preventing access to the bare, contaminated soil by fencing is most effective if other entrances and exits to the housing units can be maintained for use by residents, guests, commercial vehicles, and emergency vehicles (see Figure 11.28). Fencing may also be used to reduce exposure during a delay in the implementation of other interim control measures or soil abatement.

Educational efforts directed towards decreasing use of bare, lead-contaminated areas; avoiding eating or drinking in these areas; and frequent washing of hands may serve to reduce ingestion of the contaminated soil. The decision on whether to plant grass or erect barriers should be site-specific. Consideration should be given to the availability of alternative play areas, the location of contaminated soil with respect to entrances or exits, the likelihood that leaded dust may be tracked onto sidewalks or directly into the housing unit, the degree of supervision available, and local preferences.

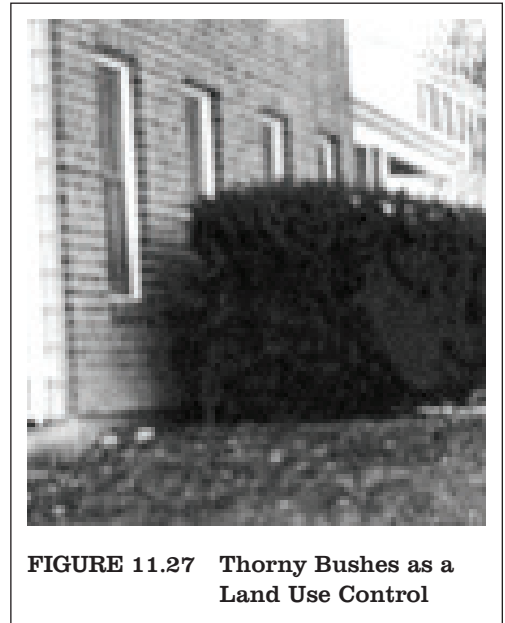


FIGURE 11.28 Using Fencing as an Interim Control. a) For Bare Soil. b) For other soil.

Table 11.6 Grasses and Their Appropriate Applications.

Grasses That Grow From Seeds	Texture	Climate	Durability
Bahia grass	Coarse	Warm	Excellent
Colonial Bent grass	Fine	Cool	—
Creeping Bent grass	Fine	Cool	—
Common Bermuda grass	Medium to Fine	Warm	Excellent
Kentucky Bluegrass	Fine	Cool	—
Rough Stalk Bluegrass	Fine	Cool	—
Centipede grass	Medium to Fine	Warm	—
Dichondra	Coarse	Warm	—
Chewings Fescue	Fine	Cool	Poor
Creeping Red Fescue	Fine	Cool	Poor
Hard Fescue	Fine	Cool	—
Tall Fescue	Coarse	Cool	Moderate to Excellent
Annual Ryegrass	Coarse	Cool	—
Perennial Ryegrass	Fine	Cool	Excellent
Grasses That Grow From Sod	Texture	Climate	Durability
Bahia grass	Coarse	Warm	Excellent
Hybrid Bermuda grass	Fine	Warm	Excellent
Kentucky Bluegrass	Fine	Cool	—
Centipede grass	Medium to Fine	Warm	Poor
Dichondra	Coarse	Warm	—
Tall Fescue	Coarse	Cool	—
Seashore Paspalum	Medium	Warm	—
Perennial Ryegrass	Fine	Cool	Excellent
St. Augustine grass	Coarse	Warm	—
Zoysia grass	Fine	Warm	Excellent

5. Reduction of Soil Tracking into Dwellings

Doormats can be used to minimize the entry of soil lead into the house. Doormats should be placed on the exterior and immediate interior of the entry doors. Mats should be cleaned by machine washing, or other wet methods, not by beating or sweeping. (See Section V of this chapter for further information.)

Removing shoes at the doorway also greatly minimizes the amount of leaded soil and dust tracked into the house.

6. Drainage and Dust Controls

Drainage controls may involve directing water flow away from the contaminated areas by alterations in adjacent grades and/or installation of drainage channels. Drainage channels that receive runoff from bare, contaminated soil areas may need to be fenced to reduce access. Dust generation can be reduced by periodic watering, the creation of windbreaks, or foot-traffic controls.

D. Making a Plan

It is recommended that a site plan of the yard be drawn to aid in planning soil lead hazard controls, and to serve as a documentation of the type and location of controls for future reference. The hazard control plan should be based on the nature and extent of hazards, yard use, topography, cost, future maintenance considerations, and property owner preference. In most situations, there is a range of acceptable treatments. Decisions are usually site specific. Working with a qualified landscaping professional to develop standards, details, and bid documents is recommended.

Often owners will be partial to certain types of soil lead hazard treatments (e.g. grass, gravel, mulch, fencing). Owners' preferences need to be balanced with lead levels, yard uses, and budget when selecting treatment methods. For example, an owner may want a lawn but grass treatments can be difficult to sustain in an urban yard due to excessive shade, compacted soil, or lack of watering by an owner. Property owner involvement in decision making will help motivate owners to maintain lead hazard control measures over time. Some important questions to ask during planning are:

- ◆ How highly contaminated is the soil?
- ◆ How is the yard used? Play, gardening, pets, picnicking, parking?
- ◆ Does the yard have primarily sunny or shady conditions?
- ◆ Are the plants selected appropriate to the yard conditions and region of the country?
- ◆ What is the budget for the project?
- ◆ Who will maintain the yard improvements after the work is completed?

E. Guidance on Specifications for Interim Controls of Soil Lead Hazards

Appendix 7.4 includes suggested language that may be helpful in drafting specifications for methods and products used in interim controls of soil lead hazards is provided below, and notes to specification developers.

Specification developers may adapt the specification language as needed to fit each particular site and each plan or design. Landscape contractors may be unfamiliar with the issue of lead in soil. Their standard practices may not be in line with lead-safe treatment methods. It is advisable to work closely with contractors on their first few lead-safe jobs to ensure that they are clear on how to properly implement interim controls. If abatement of soil lead hazards is planned, specifications should be written by a person certified in accordance with regulations of EPA or an EPA-authorized state, tribe or territory.

F. Monitoring and Maintaining Soil Interim Controls

If grass or sod is planted, or if bark, gravel, or other similar covering is used, it should be monitored visually. The monitoring should occur frequently immediately after installation and can be reduced thereafter. If ongoing monitoring shows that bare soil remains or reappears within 12 months of an interim soil control, the selected interim control is not effective. Soil abatement should be conducted (see Chapter 12), unless other interim controls can be shown to be effective for the specific site.

References

Banov, 1978. Banov, A., *Paints and Coatings Handbook*, Structures Publishing Company, Farmington, Michigan.

Brown, 1982. Brown, E, *Fundamentals of Carpet Maintenance: An Introduction Carpet Cleaning Technology*, Leeds, W. Yorkshire: P.A. Brown & Assoc.

California Department of Health Services, 2004. Public Health Institute for California Department of Health Services, Childhood Lead Poisoning Prevention Branch and Environmental Health Laboratory Branch, "Evaluation of Household Vacuum Cleaners in the Removal of Settled Lead Dust from Hard Surface Floors," Final Report to U.S. Department of Housing and Urban Development, 2004.

Cassens and Feist, 1991. Cassens, D.L., and W.C. Feist, *Exterior Wood in the South [also Northeast, Northwest, etc.], Selection, Applications and Finishes*, Technical Report FPL-GTR-69, U.S. Department of Agriculture, Forest Products Laboratory, Madison, Wisconsin, May 1991.

CH2MHILL, 1991. CH2MHILL, *Final House Dust Remediation Report for the Bunker Hill CERCLA Site Population Area RI/FS*, Boise, ID, Idaho Department of Health and Welfare, editor and sponsor. BHPA-HDR-F-RO-052091. See Summary And Assessment Of Published Information On Determining Lead Exposures And Mitigating Lead Hazards Associated With Dust And Soil In Residential Carpets, Furniture, And Forced Air Ducts, EPA 747-S-97-001 available at www.epa.gov/lead/pubs/ls_final.pdf.

City of Toronto, 1990. City of Toronto Department of Public Health in conjunction with Ontario Ministry of the Environment, *Lead Reduction Program House Dust Cleaning: Final Report*, Concord Scientific Corporation and Gore & Storrie Limited in association with South Riverdale Community Health Centre, Toronto, Montreal, Canada.

Clark, 1993. Clark, C.S., R.L. Bornschein, J. Grote, W. Menrath, W. Pan, S. Roda, and P. Succop. *Cincinnati Soil Lead Abatement Demonstration Project Final Report*, August 1993.

Clark, 2002. Clark, C.S., "Development of a Rapid On-Site Method for the Analysis of Dust Wipes Using Field Portable X-Ray Fluorescence," prepared for the U.S. Department of Housing and Urban Development, January 2002.

CMHC, 1992. Canada Mortgage and Housing Corporation, Saskatchewan Research Council Report, *Effectiveness of Cleanup Techniques for Leaded Paint Dust*, Saskatoon, Saskatchewan, Canada (also see Figley, 1994).

CPSC, 1991. Consumer Product Safety Commission, *Handbook for Public Playground Safety, Recommendations for Surfacing Materials*, Washington, DC, 1991. Updated 2008. www.cpsc.gov/cpscpub/pubs/325.pdf

EPA, 1992a. U.S. Environmental Protection Agency, *Training Course for Lead-Based Paint Abatement Project Supervisors*, Washington, DC.

EPA, 1995c. U.S. Environmental Protection Agency, *Lead-Based Paint Abatement and Repair and Maintenance Study in Baltimore: Pre-Intervention Findings*, EPA 747-R-95-012. www.epa.gov/lead/pubs/r95-012.pdf

EPA, 1997a. U.S. Environmental Protection Agency, *Laboratory Study of Lead-Cleaning Efficacy*, March 1997 (EPA 747-R-97-002). Accessed from nepis.epa.gov by searching for 747R97002.

EPA, 1997c. U.S. Environmental Protection Agency, *Summary and Assessment of Published Information on Determining Lead Exposures and Mitigating Lead Hazards Associated With Dust and Soil in Residential Carpets, Furniture and Forced Air Ducts*, December 1997 (EPA 747-S-97-001). Accessed from nepis.epa.gov by searching for 747S97001.

EPA, 1998. U.S. Environmental Protection Agency, *Lead-Cleaning Efficacy Follow-Up Study*, October 1998 (EPA 747-R-98-008).

EPA, 2000a. U.S. Environmental Protection Agency, *Basis for Educational Recommendations on Reducing Childhood Lead Exposure*, June 2000 (EPA 747-R-00-001). www.epa.gov/lead/pubs/reduc_pb.pdf

EPA, 2000x. U.S. Environmental Protection Agency, "Regulatory Status of Waste Generated by Contractors and Residents from Lead-Based Paint Activities Conducted in Households," Memorandum signed July 31, 2000. See www.epa.gov/lead/pubs/fslbp.htm. Accessed 5/3/2006; this site may be moved or deleted later.

EPA, 2001a. U.S. Environmental Protection Agency, *Lead safe Yards: Developing and Implementing a Monitoring, Assessment, and Outreach Program for Your Community*, EPA. National Risk Management Laboratory, Office of Research and Development, Cincinnati, Ohio, January 2001 (EPA/625/R-00/012). <http://www.epa.gov/region1/leadsafe/tool2.html>

EPA, 2001y. "Mold Remediation in Schools and Commercial Buildings", EPA 402-K-01-001, March 2001. Available in pdf at www.epa.gov/mold/moldresources.html, and may be ordered from:

- ◆ EPA National Service Center for Environmental Publications (NSCEP) (www.epa.gov/ncepihom/). Publication requests can also be mailed, called or faxed directly to: EPA National Center for Environmental Publications (NSCEP), P.O. Box 42419, Cincinnati, OH 42419, (800) 490-9198, (513) 489-8695 (fax); or
- ◆ IAQ INFO, P.O. Box 37133, Washington, DC 20013-7133, (800) 438-4318, (703) 356-4020, (fax) (703) 356-5386, iaqinfo@aol.com.

EPA, 2002a. U.S. Environmental Protection Agency, "Questions & Answers About ETV Reports on Portable Technologies for Measuring Lead in Dust," December 2002.

EPA, 2002b. U.S. Environmental Protection Agency, The Environmental Technology Verification Program (ETV), Verification Statements EPA-VS-SCM-50, 51, 52, 53 and 54. Prepared by Oak Ridge National Laboratory, Oak Ridge, Tennessee, August 2002.

EPA, 2002c. U.S. Environmental Protection Agency, "A Brief Guide to Mold, Moisture, and Your Home," (EPA 402-K-02-003). Available at www.epa.gov/mold/moldresources.html.

EPA, 2003w. U.S. Environmental Protection Agency, Criteria for Classification of Solid Waste Disposal Facilities and Practices and Criteria for Municipal Solid Waste Landfills: Disposal of Residential Lead-Based Paint Waste, Final Rule, Federal Register 68(117) 36487-36495: June 18, 2003. Accessed 10/10/2010 through <http://origin.www.gpoaccess.gov/fr>.

EPA, 2003x. "A Brief Guide to Mold, Moisture, and Your Home," EPA 402-K-02-003, 2003. Available in pdf format at www.epa.gov/mold/moldresources.html, also see EPA 2001y.

Ewers, 1994. Ewers, L., S. Clark, W. Menrath, P. Succop, and R. Bornschein, "Cleanup of Lead in Household Carpet and Floor Dust," *Journal of the American Industrial Hygiene Association*, 55(7): 650-7.

Farfel and Chisolm, 1987a. Farfel, M., and J.J. Chisolm, Jr., "Comparison of Traditional and Alternative Residential Lead Paint Removal Methods," in *Proceedings of the 6th International Conference on Heavy Metals in the Environment (Volume II)*, eds. S.E. Lindberg and T.C. Hutchinson, New Orleans, Louisiana, September 1987, pp. 212–214.

Farfel and Chisolm, 1987b. Farfel, M., and J.J. Chisolm, Jr., *Reducing Hazards From the Abatement of Lead Paint: Part 1—Pilot Demonstration and Evaluation of Alternative Abatement Practices*, Baltimore Integrated Environmental Management Project Phase II Report, Regulatory Integration Division, Office of Policy Analysis, Office of Policy, Planning, and Evaluation, U.S. Environmental Protection Agency.

Figley, 1994. Figley, D., and Makohon, J., "Effectiveness of Clean-Up Techniques for Leaded Paint Dust," Saskatoon, Saskatchewan: Saskatchewan Research Council, revised report SRC I-4800-38-C-92 to Canada Mortgage and Housing Corporation (originally published in 1992).

Jacobs, 1992. Testimony of D.E. Jacobs at the Hearings Before the Subcommittee on Housing and Community Development of the Committee on Banking, Part 2, S/N 102–108, U.S. House of Representatives, April 2, 7, and 29, 1992, pp. E832–842.

Lane Publishing, 1989. *Sunset Lawns and Ground Covers*, Menlo Park, California.

Lanphear, 2000. Lanphear, B.P., Eberly, S., Howard, C.S., "Long-Term Effect of Dust Control on Blood Lead Concentrations. *Pediatrics*, 106: 48e-48. <http://pediatrics.aappublications.org/content/106/4/e48.full>

Lewis, 2002. Lewis, R.D., "The Removal of Lead-Contaminated House Dust from Carpets and Upholstery, Final Report," prepared for U.S. Department of Housing and Urban Development, Office of Healthy Homes and Lead Hazard Control, January 2002.

Lewis, 2006. Roger D. Lewis, Sridhar Condoor, Joe Batek, Kee Hean Ong, Denis Backer, David Sterling, Jeff Siria, John J. Chen, and Peter Ashley, "Removal of Lead Contaminated Dusts from Hard Surfaces," *Environ. Sci. Technol.*, 40, 590–594, 2006. <http://pubs.acs.org/doi/abs/10.1021/es050803s>.

Maryland Cooperative Extension, 1994. Lawn Care Ruler, FS-637R.

Milar, 1982. Milar, C.R. and P. Mushak, "Contaminated House Dust: Hazard, Measurement and Decontamination," in *Lead Absorption in Children: Management, Clinical, and Environmental Aspects*, eds., J.J. Chisolm and D.M. O'Hara, Urban & Schwarzenberg, Baltimore/Munich, pp. 143–152.

NCHH, 2004. National Center for Healthy Housing, and University of Cincinnati Department of Environmental Health, *Evaluation of the HUD Lead-Based Paint Hazard Control Grant Program: Final Report*, prepared for the U.S. Department of Housing and Urban Development, Washington, DC, May 1, 2004.

Rich, 2002. Rich, David Q., G.G. Rhoads, L. Yiin, J. Zhang, Z. Bai, J.L. Adgate, P.J. Ashley and P.L. Liyo, "Comparison of Home Lead Dust Reduction Techniques on Hard Surfaces: The New Jersey Assessment of Cleaning Techniques Trial," *Environmental Health Perspectives*, 110(9): 889–893, September 2002. <http://www.ncbi.nlm.nih.gov/pmc/articles/PMC1240988/>; doi:10.1289/ehp.02110889

Roberts, 1991. Roberts, J.W., D.E. Camann, and T.M. Spittler, "Reducing Lead Exposure From Remodeling and Soil Track-In in Older Homes," in *Proceedings of the Annual Meeting of Air and Waste Management Association*, Paper No. 91–134.2, Vancouver, British Columbia, Canada.

- Roberts, 1999. Roberts, J.W., W.S. Clifford, G. Glass, and P.G. Hummer, "Reducing Dust, Lead and Dust Mites, Bacteria and Fungi in Carpets by Vacuuming," *Archives of Environmental Contamination and Toxicology*, 36: 477-484.
- Roberts, 2002. Roberts, J.W., Letter from John W. Roberts to Jackson L. Anderson, National Center for Healthy Housing, September 27, 2002.
- Roberts, 2004. Roberts, J.W., Glass, G, and Mickelson, L., "A Pilot Study of the Measurement and Control of Deep Dust, Surface Dust, and lead in 10 Old Carpets using the 3-Spot Test While Vacuuming," *Archives of Environmental Contamination and Toxicology*, 48: 16-23.
- Tohn, 2000. Tohn, E.R., S.L. Dixon, D. Rupp and C.S. Clark, "A Pilot Study Examining Changes in Dust Lead Loadings on Walls and Ceilings After Lead Hazard Control Interventions," *Environmental Health Perspectives*, 105(5): 453-456. <http://ehp03.niehs.nih.gov/article/info%3Adoi%2F10.1289%2Fehp.00108453>; doi:10.1289/ehp.00108453
- Tohn, 2003. Tohn, E.R., S.L. Dixon, W.A. Galke and C.S. Clark, "An Evaluation of One-Time Professional Cleaning in Homes With Lead-Based Paint Hazards," *Journal of Applied and Occupational Hygiene*, 18(2): 138-143.
- Wang, 1995. Wang, E., G.G. Rhoads, T. Wainman and P.J. Lioy, "Effects of Environmental and Carpet Variables on Vacuum Sampler Collection Efficiency," *Applied Occupational Environmental Hygiene*, 10(2): 111-119.
- Yiin, 2002. Yiin, Lih-Ming, F.F. Rhoads, D.Q. Rich, J. Zhang, Z. Bai, J.L. Adgate, P.J. Ashley and P.J. Lioy, "Comparison of Techniques to Reduce Residential Lead Dust on Carpet and Upholstery: The New Jersey Assessment of Cleaning Techniques Trial," *Environmental Health Perspectives*, 110(12): 1-5. <http://ehp03.niehs.nih.gov/article/fetchArticle.action?articleURI=info%3Adoi%2F10.1289%2Fehp.021101233>

Chapter 12: Abatement

ABATEMENT – HOW TO DO IT	12-5
BUILDING COMPONENT REPLACEMENT – HOW TO DO IT	12-6
ENCLOSURE METHODS – HOW TO DO IT	12-7
PAINT REMOVAL METHODS – HOW TO DO IT	12-8
SOIL AND EXTERIOR DUST ABATEMENT – HOW TO DO IT	12-9
I. Principles of Lead-Based Paint Hazard Abatement	12-11
A. Longevity of Abatement	12-11
B. Prohibited Abatement Methods	12-13
C. Vacuum Cleaning	12-13
D. Periodic Monitoring and Reevaluation	12-14
E. Types of Abatement	12-14
F. Encapsulation	12-15
G. Relationship to Renovation, Repainting, Remodeling, Rehabilitation, Weatherization, and Other Construction Work	12-15
II. Building Component Replacement	12-16
A. Worksite Preparation	12-16
1. Security	12-16
2. Planning for Waste Storage	12-18
B. General Procedures for Building Component Replacement	12-18
C. Removal and Replacement Procedures for Specific Components	12-19
1. Baseboards, Casings, and Other Trim	12-19
2. Windows	12-19
3. Interior and Exterior Doors	12-20
4. Kitchen and Bathroom Cabinets	12-21
5. Railings	12-22
6. Exterior Siding	12-22
7. Interior Walls	12-23
D. Transportation and Storage of Waste	12-23
III. Enclosure Methods	12-24
A. Definition	12-24
B. Longevity of Enclosures	12-24
1. Labeling of Surfaces to be Enclosed	12-24
2. Unsound Substrates	12-25
3. Ongoing Monitoring and Reevaluation	12-25
C. Interior Surface Enclosure Materials	12-26

1. Wood Paneling	12-26
2. Laminated Products	12-26
3. Rigid Tile and Brick Veneers	12-26
4. Drywall and Fiberboard	12-27
D. Interior Building Components Suitable for Enclosures	12-28
1. Wood Trim and Drywall	12-28
2. Electrical Outlets and Vents	12-28
3. Ceilings	12-28
4. Floors	12-29
5. Stairs	12-30
6. Pipes	12-30
7. Door Frames	12-30
8. Plywood Enclosures	12-31
E. Exterior Enclosure Systems	12-31
1. Siding	12-31
2. Windows	12-32
3. Exterior Walls	12-32
F. Summary	12-32
IV. Paint Removal Methods	12-33
A. Introduction	12-33
B. Prohibited Methods	12-33
1. Open Flame Burning or Torching	12-33
2. Machine Sanding or Grinding Without a HEPA Exhaust Tool	12-34
3. Abrasive Blasting or Sandblasting	12-34
4. Heat Guns Above 1100° F	12-35
5. Dry Scraping	12-35
6. Chemical Paint Stripping in a Poorly Ventilated Space	12-35
C. Recommended Methods of Paint Removal	12-36
1. Heat Guns	12-36
2. Mechanical Removal Methods	12-37
3. Chemical Removal Methods	12-39
D. Waste Disposal	12-43
V. Soil and Exterior Dust Abatement	12-43
A. Introduction	12-43
B. Soil Abatement Methods	12-44
1. Soil Removal and Replacement	12-44
2. Soil Cultivation	12-48
3. Paving	12-49
4. Other Soil Treatment Methods Under Study.....	12-49
C. Exterior Dust Control	12-49

1. Types of Equipment	12-50
2. Evaluation of Equipment	12-50
3. Removal of Heavy Accumulation	12-51
4. Vacuum Cleaning	12-51
REFERENCES	12-52
FIGURES	
Figure 12.1 Removing and Replacing Trim: interior (left), exterior (right).	12-19
Figure 12.2 Protecting the interior of a unit for exterior window abatement.	12-20
Figure 12.3 Replacement window system.....	12-20
Figure 12.4 Pre-and post-abatement interior doors.	12-21
Figure 12.5 A metal railing before abatement.	12-22
Figure 12.6 Installation of replacement siding.	12-22
Figure 12.7 Certified workers are needed to replace siding when the project's intent is lead abatement.....	12-22
Figure 12.8 Line surfaces with plastic in the work area (left) and pathways (right).....	12-23
Figure 12.9 Example of a Diagram Showing the Location of Lead-Based Paint Enclosures.	12-25
Figure 12.10 Install underlayment and new flooring as a suitable LBP enclosure method.....	12-29
Figure 12.11 Enclosed stairs.....	12-30
Figure 12.12 Seal All Seams for Enclosure.	12-31
Figure 12.13 Prohibited work practices (traditional abrasive blasting (left) and grinding without HEPA exhaust).....	12-34
Figure 12.14 Using a heat gun to remove paint is labor-intensive.....	12-36
Figure 12.15 HEPA-filtered power tools.....	12-37
Figure 12.16 Wet scraping (left)	12-38
Figure 12.17 Scraping tools (right).	12-38
Figure 12.18 Vacuum blasting is not often used on housing.	12-39
Figure 12.19 Needle Gun with HEPA Exhaust Ventilation.	12-39
Figure 12.20 Workers should wear protective clothing when using chemicals.	12-40
Figure 12.21 Eye- and body-wash stations are required when working with corrosive or irritant chemicals.	12-41
Figure 12.22 Replacing resident pathway after soil removal.	12-47
Figure 12.23 Preparing to pave high traffic area.....	12-49



TABLES

Table 12.1	Prohibited Lead-Based Paint Abatement Methods.	12-13
Table 12.2	Comparison of Lead-Based Paint Abatement, Component Removal and Enclosure	12-17
Table 12.3	Steps To Install Drywall and Fiberboard on Interior Walls.	12-27

Chapter 12: Abatement

Abatement – How To Do It

1. **Arrange for risk assessment or paint inspection.** Have a lead hazard risk assessment or lead-based paint inspection performed by a certified risk assessor or a certified inspector who is independent of the abatement contractor.
2. **Develop hazard control plan.** Develop a site-specific lead hazard control plan based on the hazards (risk assessment) or lead-based paint (inspection) identified and financing available. Prepare the work area (see Chapter 8); avoid high-dust jobs and procedures.
3. **Obtain waste permits.** Have the contractor obtain any necessary building or waste permits; notify local authorities if the local jurisdiction requires it.
4. **Select needed materials.** Together with the contractor (or designer or risk assessor), select specific building component replacement items, enclosure materials, paint removal equipment and/or chemicals, tools, and cleaning supplies. Consider waste management and historic preservation implications of the selected treatment.
5. **Develop specifications.** Develop specifications (usually for large projects only).
6. **Schedule other construction work.** Schedule other construction work so that leaded surfaces are not inadvertently disturbed and unprotected workers are not placed at risk. Include time for clearance examinations and laboratory dust sample analysis in the scheduling process (see Chapters 3 and 15).
7. **Select a contractor.** Select a certified abatement contractor using the lowest *qualified* bidder.
8. **Conduct preconstruction conference.** Conduct a preconstruction conference to ensure the contractor fully understands the work involved (for large projects only).
9. **Notify residents.** Notify residents of the dwelling and adjacent dwellings of the work and the date when it will begin. Implement relocation (if appropriate).
10. **Correct housing conditions that might impede work.** Correct any existing conditions that could impede the abatement work (e.g., trash removal, structural deficiencies).
11. **Post warning signs.** Post warning signs and restrict entry to authorized personnel only. Implement the worksite preparation procedures.
12. **Consider a pilot project.** For large projects only, consider conducting a pilot project to determine if the selected abatement method will actually work (pilot projects are sometimes completed before step 4).
13. **Consider collecting soil samples as an option.** As an optional quality control procedure, consider collecting pre-abatement soil samples, which may not have to be analyzed until post-abatement soil samples have been collected, analyzed, and compared to clearance standards. If post-abatement soil levels are below applicable limits, the pre-abatement samples need not be analyzed (see Chapter 15). Soil sampling is not required by EPA regulations as part of clearance. This is an optional activity (see Chapter 15).

14. **Execute construction work.** Execute abatement work. See the other sections of this chapter for step-by-step summaries for building component replacement, enclosure, paint removal, and soil abatement methods. See Chapter 13 for encapsulation methods. Observe local or State regulations if applicable.
15. **Store waste.** Store all waste in a secure area (see Chapter 10).
16. **Cleanup.** Conduct daily and final cleanup (see Chapter 14). Execute waste disposal procedures.
17. **Arrange for clearance.** Have an independent certified inspector technician or risk assessor conduct a clearance examination after waiting at least 1 hour after cleanup has been completed to let dust settle (see Chapter 15).
18. **Repeat cleaning if clearance fails.** If clearance is not achieved, repeat cleaning and/or complete abatement work. Repeat clearance examination and, if clearance is achieved, obtain any required formal release or, if required by the U.S. Department of Housing and Urban Development (HUD) or local authorities, owner's certification that the project has been completed required.
19. **Pay contractors.** Pay contractor and clearance examiner.
20. **Conduct periodic monitoring.** Conduct periodic monitoring and reevaluation of enclosure or encapsulation systems (if applicable) or lead-based paint that was not abated as indicated in Chapter 6. Maintain records of all abatement, monitoring, reevaluation, and maintenance activities, and turn them over to any new owner upon sale of the property as part of lead disclosure. Provide proper disclosure and notification to tenants. See Appendix 6 for more information.

Building Component Replacement – How To Do It

1. **Prepare work area and plan new component installation.** Prepare the work area (see Chapter 8); avoid high-dust jobs and procedures. Plan how the new component will be installed. Whenever possible, use new, energy efficient window, door, and insulating systems.
2. **Prepare building component for removal.** Prepare the building component for removal. Turn off and disconnect any electrical circuits inside or near the building component to be removed.
3. **Mist component.** Lightly mist the component to be removed (unless electrical circuits are nearby).
4. **Score seams.** Score all painted seams with a sharp knife.
5. **Remove screws.** Remove any screws, nails, or fasteners.
6. **Pry component.** Use a flat pry instrument (crowbar) and hammer to pry the component from the substrate.
7. **Remove nails.** Remove or bend back all nails.
8. **Wrap component.** Wrap and seal bulk components in plastic and take them to a covered truck or secured waste storage area along pathways covered with plastic. Shovel any debris; see Chapter 10 for proper disposal methods.
9. **Vacuum dust.** Vacuum any dust or chips in the area where the component was located.

14. **Execute construction work.** Execute abatement work. See the other sections of this chapter for step-by-step summaries for building component replacement, enclosure, paint removal, and soil abatement methods. See Chapter 13 for encapsulation methods. Observe local or State regulations if applicable.
15. **Store waste.** Store all waste in a secure area (see Chapter 10).
16. **Cleanup.** Conduct daily and final cleanup (see Chapter 14). Execute waste disposal procedures.
17. **Arrange for clearance.** Have an independent certified inspector technician or risk assessor conduct a clearance examination after waiting at least 1 hour after cleanup has been completed to let dust settle (see Chapter 15).
18. **Repeat cleaning if clearance fails.** If clearance is not achieved, repeat cleaning and/or complete abatement work. Repeat clearance examination and, if clearance is achieved, obtain any required formal release or, if required by the U.S. Department of Housing and Urban Development (HUD) or local authorities, owner's certification that the project has been completed required.
19. **Notify Residents.** Notify residents of affected dwellings of the nature and results of the abatement work.
20. **Pay contractors.** Pay contractor and clearance examiner.
21. **Conduct periodic monitoring.** Conduct periodic monitoring and reevaluation of enclosure or encapsulation systems (if applicable) or lead-based paint that was not abated as indicated in Chapter 6. Maintain records of all abatement, monitoring, reevaluation, and maintenance activities, and turn them over to any new owner upon sale of the property as part of lead disclosure. Provide proper disclosure and notification to tenants. See Appendix 6 for more information.

Building Component Replacement – How To Do It

1. **Prepare work area and plan new component installation.** Prepare the work area (see Chapter 8); avoid high-dust jobs and procedures. Plan how the new component will be installed. Whenever possible, use new, energy efficient window, door, and insulating systems.
2. **Prepare building component for removal.** Prepare the building component for removal. Turn off and disconnect any electrical circuits inside or near the building component to be removed.
3. **Mist component.** Lightly mist the component to be removed (unless electrical circuits are nearby).
4. **Score seams.** Score all painted seams with a sharp knife.
5. **Remove screws.** Remove any screws, nails, or fasteners.
6. **Pry component.** Use a flat pry instrument (crowbar) and hammer to pry the component from the substrate.
7. **Remove nails.** Remove or bend back all nails.
8. **Wrap component.** Wrap and seal bulk components in plastic and take them to a covered truck or secured waste storage area along pathways covered with plastic. Shovel any debris; see Chapter 10 for proper disposal methods.
9. **Vacuum dust.** Vacuum any dust or chips in the area where the component was located.

10. **Replace component** (optional).
11. **Cleanup.** Conduct cleaning (see Chapter 14).
12. **Conduct clearance.** Conduct clearance and reclean if necessary.

Enclosure Methods – How To Do It

1. **Post warnings on affected components.** Stamp, label, or stencil all lead-based painted surfaces that will be enclosed with a warning approximately every 2 feet both horizontally and vertically on all components. The warning should read: "Danger: Lead-Based Paint." Deteriorated paint should not be removed from the surface to be enclosed.
2. **Determine whether low- or high-dust job.** Prepare the worksite in accordance with guidance in Chapter 8; avoid high-dust jobs and procedures.
3. **Identify enclosure.** Attach a durable drawing to the utility room or closet showing where lead-based paint has been enclosed in the dwelling.
4. **Plan for monitoring.** Plan for annual monitoring of the enclosure by the owner.
5. **Repair substrates.** Repair unsound substrates and structural members that will support the enclosure, if necessary.
6. **Select enclosure material.** Select appropriate enclosure material (drywall or fiberboard, wood paneling, laminated products, rigid tile and brick veneers, vinyl, aluminum, or plywood).
7. **Prepare electrical fittings.** Install extension rings for all electrical switches and outlets that will penetrate the enclosure.
8. **Clean floors.** If enclosing floors, remove all dirt with a vacuum to avoid small lumps in the new flooring.
9. **Seal seams.** Seal and back-caulk all seams and joints. Back-caulk means applying caulk to the underside of the enclosure.
10. **Anchor enclosures.** When installing enclosures directly to a painted surface, use adhesive and then anchor with mechanical fasteners (nails or screws).
11. **Conduct cleanup.**
12. **Arrange for clearance.** Have a certified risk assessor or inspector technician conduct clearance testing and provide documentation.

Paint Removal Methods – How To Do It

1. **Use only approved removal methods.** Be sure all paint-removal methods are not prohibited methods. Avoid the following:
 - a. Open flame burning or torching.
 - b. Heat guns operating above 1100 °F.
 - c. Machine sanding or grinding without a HEPA vacuum exhaust tool.
 - d. Abrasive blasting or sandblasting without a HEPA vacuum exhaust tool.
 - e. Paint stripping in a poorly ventilated space using volatile stripper.
 - f. Dry scraping (except for limited areas).
2. **Determine whether low- or high-dust job.** Prepare the worksite in accordance with guidance in Chapter 8; avoid high-dust jobs and procedures.
3. **Ensure safe use of heat guns.** For heat gun work, provide fire extinguishers in the work area and ensure that adequate electrical power is available. Use for limited areas only. Train workers to avoid gouging or abrading the substrate.
4. **When using mechanical tools, USE only HEPA-equipped tools.** Be sure workers keep the shroud against the surface being treated. Vacuum blasting and needle guns should not be used on wood, plaster, drywall, or other soft substrates. Observe the manufacturer's directions for the amount of vacuum airflow required.
5. **Wet scrape.** For wet scraping, use a spray bottle or wet sponge to keep the surface wet while scraping. Apply enough water to moisten the surface completely, but not so much that large amounts run onto the floor or ground. Do not moisten areas near electrical circuits.
6. **Use off-site chemical stripping facilities, if feasible.** For chemical paint removers, determine if the building component can be removed and stripped off-site. Off-site stripping is generally preferred to on-site paint removal. Observe all manufacturers' directions for use of paint removers.
7. **Remove components carefully.** For off-site stripping, determine how to remove the component. Score the edges with a knife or razor blade to minimize damage to adjacent surfaces. Punch or tag the building component if similar building components are also being stripped off-site (e.g., doors). This will ensure that the individual component is reinstalled in the original location. Inform the off-site paint remover that lead-based paint is present before shipping. Wrap the component in plastic and send to the off-site stripping location. Clean all surfaces before reinstallation to remove any lead residues by vacuuming all surfaces, cleaning with other lead specific or all-purpose cleaners detergents, and vacuuming again. Conduct cleanup and clearance.
8. **Test effectiveness of on-site stripper, if used.** For on-site paint removal, first test the product on a small area to determine its effectiveness. Chemical paint removers may not be effective or desirable on exterior, deteriorated wood surfaces, aluminum, and glass. Provide neoprene, nitrile, rubber, or polyvinyl chloride (PVC) gloves (or other type of glove recommended by the manufacturer); face shields; respirators with combination filter cartridges for leaded-dust and organic vapors (if appropriate); and

chemical-resistant clothing. Be sure to select the right type of organic vapor filter cartridge, gloves, and clothing for the specific chemical being used. Portable eyewash stations capable of providing a 15-minute flow must be on-site. Apply the chemical and wait the required period of time. Maintain security overnight to prevent passersby from coming into contact with the chemical. For caustic chemical paint removers, neutralize the surface before repainting using glacial acetic acid (not vinegar). Repaint and conduct cleanup and clearance.

9. **Dispose of waste properly** (see Chapter 10).
10. **Conduct cleanup.**
11. **Arrange for clearance.** Have a certified risk assessor or lead-based paint inspector conduct a clearance examination and provide documentation (see Chapter 15).

Soil and Exterior Dust Abatement – How To Do It

1. **Identify any soil hazard.** Determine if a soil-lead hazard exists. For a hazard to exist, a total of at least 9 square feet of soil in a single yard or area must be bare and soil concentrations must be equal to or exceed either 1,200 $\mu\text{g/g}$ of lead for the yard or building perimeter or 400 $\mu\text{g/g}$ of lead for small, high-contact play areas. Bare soil above these levels should be treated by either interim controls or abatement. Soil abatement is most appropriate when levels of lead are extraordinarily high (equal to or greater than 5,000 $\mu\text{g/g}$) and when use patterns indicate contact frequency and exposure will be high.
2. **Optionally, collect pre-abatement soil samples.** As an option, collect pre-abatement soil samples to determine baseline levels. These samples need not be analyzed if post-abatement soil samples are below applicable clearance levels.
3. **Determine soil abatement method.** Determine the method of soil abatement (soil removal and replacement, soil cleaning, or paving). Soil cultivation (rototilling or turning over the soil) is not recommended.
4. **Prepare carefully for paving.** If paving, use a high-quality concrete or asphalt. Observe normal precautions associated with traffic load weight and thermal expansion and contraction. Obtain any necessary permits. Keep soil cultivation to a minimum.
5. **Plan soil removal carefully.** If removing and replacing soil:
 - ◆ Determine if waste soil will be placed in an on-site or off-site burial pit. Prepare vehicle operation and soil movement plan. Test new replacement soil (should not contain more than 400 $\mu\text{g/g}$ lead).
 - ◆ Contact the local information source to determine location of underground utilities, including water, gas, electric, cable TV, and sewer, or contact each utility individually. Mark all locations to be avoided.
 - ◆ Remove fencing if necessary to allow equipment access and define site limits with temporary fencing, signs, or yellow caution tape.
 - ◆ Tie and protect existing trees, shrubs, and bushes.
 - ◆ Have enough tools to avoid handling clean soil with contaminated tools.

- ◆ Remove soil.
 - ◆ Clean all walkways, driveways, and street areas near abatement area.
 - ◆ Replace soil at proper grade to allow drainage.
 - ◆ Replacement soil should be at least 2 inches above existing grade to allow for settling.
 - ◆ Install new soil covering (grass or sod) and maintain it through the growing season.
 - ◆ Have enough workers and equipment available to complete the job in 1 day.
6. **Manage disposal of soil waste carefully** (see Chapter 10).
 7. **Conduct final cleanup and visual inspection for clearance** (see Chapter 15).
 8. **Provide walk-off mat(s) for residents.** Provide walk-off doormats to residents and educate them on the benefits of removing shoes at the dwelling entryway.

I. Principles of Lead-Based Paint Hazard Abatement

A. Longevity of Abatement

There are several approaches to abatement. Abatement is either: the removal of the building component, the removal of the paint itself, or the long-lasting – at least 20 years – enclosure or encapsulation of lead-based paint hazards. (For enclosure, see Section III of this chapter, and for encapsulation, see Chapter 13.) From a public health perspective, properly conducted abatement is the preferred permanent or long-lasting response to lead hazards. Abatement has two principal advantages: it provides a long-term solution, and little (if any) monitoring or reevaluation of the treated surface is necessary because failure is less likely to occur. Abatement treatments provide longer-lasting safe conditions than interim controls because the effectiveness of the work is less dependent on resident action, maintenance of housing stock, the conscientiousness of property managers, and the attention of maintenance workers during repair.

As used in this chapter, abatement can mean either correction of lead-based paint *hazards* (as defined in Title X) or removal, “permanent” encapsulation or “permanent” enclosure of all lead-based paint, as describe below. The methods explained in this chapter apply to abatement of both lead-based paint hazards *and* lead-based paint. From the Federal perspective, construction activities intending only to remodel, renovate or paint, are not considered abatement. Abatement does include work intending to permanently eliminate lead-based paint or lead-based paint hazards.

Interim controls, abatement, or a combination of the two are acceptable methods of addressing lead-based paint hazards. In contrast to interim controls, lead-based paint abatement refers to a group of measures that can be expected to eliminate or reduce exposures to lead hazards for at least 20 years under normal conditions. As 20 years is the expected lifespan of many commonly used building components, abatement is the closest one can get to a “permanent” solution in housing. The abatement methods described in this chapter should be capable of lasting 20 years under typical conditions. Any methods developed in the future that also last 20 years will be acceptable as abatement methods. This orientation toward performance standards should provide owners and the abatement industry with opportunities for innovation and flexibility, ensuring that the abatement method selected is the one that is most cost effective for a particular component.

The term “abatement” also includes a number of other activities that are not directly related to the work itself, but that must be included in the overall effort for the abatement to be successful. These activities include lead hazard evaluation, planning, cleaning, clearance, and waste disposal and are covered elsewhere in these *Guidelines*. The reader must study and understand the material in these other chapters prior to undertaking an abatement project. This chapter alone does not provide all the information necessary to complete a successful abatement job. When abatement is performed inadequately, or without sufficient protection, lead exposures to children increase (Amitai, 1987; Chisholm, 1985; Farfel, 1990; Rabinowitz, 1985a). When performed properly, abatement is known to be effective (Amitai, 1991; Staes, 1994; HUD, 1991; Jacobs, 1993a; Farfel, 1994a; Staes and Rinehart, 1995).

Abatement refers to any measure designed to permanently eliminate lead-based paint or lead-based paint hazards in accordance with standards established by the U.S. Environmental Protection Agency (EPA) pursuant to Title IV of the Toxic Substances Control Act (TSCA). Abatement strategies include removal of lead-based paint; enclosure of lead-based paint; encapsulation of lead-based paint (according to the standards and procedures set forth in Chapter 13); replacement of building

components coated by lead-based paint; removal of lead-contaminated dust; removal or covering of lead-contaminated soil with a durable covering (not grass, gravel, or sod, which are considered interim control measures); and preparation, cleanup, disposal, post-abatement clearance testing, recordkeeping, and monitoring (if applicable).

More than any other abatement method, on-site paint removal involves the greatest degree of disturbance and dust generation. Therefore, on-site removal of lead-based paint from a substrate should be carried out only if abatement rather than interim control is required and no other abatement method is feasible. For example, removal of paint from metal doorframes may be the only feasible abatement option, especially if the frames cannot be removed or enclosed and the paint cannot be stabilized. Paint removal may increase the level of lead in household dust and make effective cleaning more difficult. Even if dust clearance standards are met, any increase in leaded-dust levels over baseline levels means some increase in exposure. Furthermore, all paint removal methods leave behind some residues embedded in the substrate, which could continue to pose a hazard if the surface from which the paint is removed is later disturbed. Therefore, paint removal is the most invasive of abatement methods and should be avoided if possible.

Abatement also offers the greatest challenge to planning, since it is often performed in the context of other building construction work, while interim controls are more likely to be performed alone or as part of other maintenance work.

In fact, many forms of abatement require special construction skills in addition to protective measures and dust control techniques. For example, one of the most common forms of lead-based paint abatement is window replacement. Abatement contractors need to possess adequate carpentry skills to install (for example) new windows, as well as the demolition, dust containment, and cleaning skills held by abatement contractors. While providing some guidance, this chapter is not intended to impart carpentry, painting, resurfacing, and other construction knowledge required for most types of abatement. Abatement contractors should either subcontract this type of construction work or acquire the necessary construction skills before the job begins. Of course, all construction work must be performed in accordance with local code requirements and all abatement work must be done by certified firms and individuals.

Many forms of abatement can be integrated into construction work, which provides an opportunity to install systems that will have long-term impact. For example, whenever building components, such as doors and windows, are replaced, the *Guidelines* recommend that they be replaced with products that are more energy efficient. This will help reduce energy consumption and increase cost efficiency.

EPA has established standard training curricula and regulations for the training and certification of all individuals engaged in lead-based paint risk assessment, inspection, and abatement, and minimum performance standards for the purpose of certifying individuals who supervise lead abatement projects and conduct clearance examinations. EPA's regulations are generally implemented through State, Tribal, or territorial programs. All abatement contractors and firms must be certified to perform this type of work, and all abatement workers and supervisors must be trained and certified. Certification of abatement contractors and completion of clearance examinations by independent, certified risk assessors, lead-based paint inspectors or sampling technicians, ensures that abatement work is conducted properly and safely.

For exterior work, as an optional quality control procedure, consider collecting pre-abatement soil samples, which may not be analyzed until post-abatement soil samples have been collected,

analyzed and compared to clearance standards. If post-abatement soil levels are below applicable limits, the pre-abatement samples need not be analyzed. Soil sampling is not required by EPA regulations as part of clearance. This is an optional activity (see Chapter 15).

B. Prohibited Abatement Methods

HUD and EPA prohibit certain techniques (see 24 CFR 35.140, and 40 CFR 745.227(e)(6), respectively) because they are known to produce extremely high levels of lead exposure and make dwellings difficult to clean up. In addition, for abatement in federally-owned and assisted residences, HUD prohibits an additional technique if toxic volatile chemical stripping compounds are used, in order to prevent hazardous levels of the chemicals in the air of the residence being abated. See Table 12.1. State and local regulations may also prohibit some or all of these techniques or other techniques.

These *Guidelines* recommend strongly against the use of uncontained hydroblasting. Removal of paint using this method can spread paint chips, dust, and debris beyond the work area. Pressure washing is also discouraged. Contained pressure washing at less than 5,000 pounds per square inch (PSI) can be done within a protective enclosure to prevent the spread of paint chips, dust, and debris. Water runoff should also be contained (see Chapter 8).

Table 12.1 Prohibited Lead-Based Paint Abatement Methods.

1. Open flame burning or torching (includes propane-fueled heat grids).
2. Machine sanding or grinding without HEPA local vacuum exhaust tool.
3. Abrasive blasting or sandblasting without HEPA local vacuum exhaust tool.
4. Heat guns operating above 1100° F or charring the paint.
5. Dry scraping (except for limited surface areas).
6. Paint stripping in a poorly ventilated space using volatile stripper.

C. Vacuum Cleaning

In this chapter, vacuum cleaning is recommended a number of times. These *Guidelines* recommend that a HEPA-filtered (high-efficiency particulate air) vacuum should be used if possible, but that a high-quality household or commercial vacuum should be used if a HEPA vacuum is not available. (Note that, for RRP work, EPA's RRP Rule requires that any vacuum cleaners used be HEPA-filtered; see Chapter 11.) See Section III.A of Chapter 14 for a discussion of factors in choosing an effective vacuum cleaner and Section V of Chapter 11 for cleaning of carpets.

D. Periodic Monitoring and Reevaluation

Among the advantages of abatement compared to interim controls is that ongoing monitoring by the owner is either unnecessary (in the case of complete lead-based paint removal) or relatively simple (in the case of enclosure or encapsulation). Failures of enclosures and encapsulations are relatively easy to observe visually. (Failures should be repaired immediately. See Chapter 6.) Also, whereas professional independent reevaluation may be required at 2-year intervals for some federally assisted multi-family properties that have been treated with interim controls or standard treatments, such reevaluation is not necessary for properties that have had all lead-based paint abated. This is true even if lead-based paint has been enclosed or encapsulated, *provided* ongoing visual monitoring and lead-safe maintenance are performed by the owner in assisted units as recommended in Chapter 6. (Also see Chapter 5 on reevaluation.)

Abatement can be undertaken after lead-based paint inspections or risk assessments determine the presence of lead-based paint or other lead hazards (see Chapters 3, 5 and 7 for a description of the differences between risk assessments and inspections). If this initial evaluation phase is not completed, then all painted surfaces must be presumed to contain lead-based paint. This presumption may be cost-effective if it is likely that all surfaces that might be treated contain lead-based paint or if the housing unit is to be rehabilitated and all surfaces and components will be either covered or replaced.

The cost of a carefully conducted lead-based paint inspections or risk assessments, however, is usually recovered by a more focused abatement effort, especially when component replacement or enclosure is considered. The cost savings of a more targeted abatement effort based on complete testing are noteworthy in the case of abatement as opposed to interim controls, because the costs of abatement are initially much higher than interim controls.

Recordkeeping

Recordkeeping is essential for all abatement methods. The location of enclosed or encapsulated lead-based paint must be made known to future residents and owners, who may undertake remodeling or repair efforts that could disturb the remaining lead-based paint and thereby create a lead-based paint hazard. Depending on the jurisdiction, the location of enclosed or encapsulated lead-based paint may need to be filed with the appropriate municipal agency for future reference when the agency needs to issue construction permits for renovation. Provide proper disclosure and notification to current tenants as well (see Appendix 6).

E. Types of Abatement

This chapter covers four types of abatement:

- ◆ Building component replacement.
- ◆ Enclosure systems (this section does not include encapsulation, which is addressed in Chapter 13).
- ◆ On-site and off-site paint removal.
- ◆ Soil removal or covering.

The available information on paint abatement methods is summarized in Table 12.2. The reader should not conclude that a particular method is not permitted simply because it is not discussed here. With the exception of the prohibited techniques listed above, new techniques should be developed, studied, and reported to HUD, the Centers for Disease Control and Prevention (CDC), EPA, and other Government agencies for distribution to the public.

F. Encapsulation

Encapsulants are coatings or rigid materials that rely on adhesion to a lead-based painted surface and are not mechanically fastened to the substrate. Encapsulants are considered separately in Chapter 13. *Enclosures* (not to be confused with encapsulants) are defined as durable, rigid construction materials that are mechanically fastened to the substrate with screws, nails, or other mechanical fastening system that can be expected to last at least 20 years under normal conditions. (See Section III of this chapter on enclosures.) These *Guidelines* do not consider encapsulation to be the same as enclosure. Depending on the particular circumstances and product, encapsulation can be either a form of paint stabilization (an interim control) or abatement (see Chapter 13).

G. Relationship to Renovation, Repainting, Remodeling, Rehabilitation, Weatherization, and Other Construction Work

Many forms of abatement involve the same physical work as other types of construction often performed in housing. In many cases, only the intent of the work differs. Lead-based paint abatement is intended to produce conditions that prevent lead poisoning. Other construction work is intended, among other things, to improve aesthetic living conditions, bring the dwelling up to code, preserve historical evidence, and promote energy efficiency. For example, depending on its intent, window replacement could be considered to be a lead-abatement method, renovation work, or energy conservation/weatherization work.

HUD's Lead Safe Housing Rule requirements vary depending on the type and amount of federal housing assistance (see Appendix 6) (HUD, 1999). The Rule applies to certain private owners and specific federally-funded housing activities. Individuals at the State or local level who are responsible for making determinations about weatherization or rehabilitation projects must have a clear understanding of the federal requirements applicable to specific funding sources. DOE-funded weatherization work is considered to be "renovation" under EPA's RRP rule (See Chapter 4; see also DOE, 2002).

It is well known that lead-based paint-disturbing activities have the potential to create dust-lead hazards. Therefore, regardless of funding source, HUD strongly recommends that all activities disturbing known or presumed lead-based paint use trained workers, lead-safe work practices and undergo a clearance examination.

While the intentions of each of these activities differ, experience shows that many of them can be combined in order to yield savings. In the public housing program, for example, most of the abatement occurs in the context of housing modernization or rehabilitation work. This approach has proven to be feasible and cost effective.

Congress recognized the wisdom of combining lead abatement with rehabilitation work. Under Title X, any residential construction job receiving more than \$25,000 per dwelling unit in Federal rehabilitation funds is *required* to have all lead-based paint hazards on the property abated. If \$5,000 to \$25,000 per dwelling unit in Federal rehabilitation funding is received, either interim controls or abatement must be implemented (HUD, 2009).

Finally, lead abatement procedures cannot guarantee that children will not be exposed to lead in the future. Enclosure systems or encapsulants could fail, exposing the hazard again. Soil coverings could also fail, or other sources of lead could recontaminate the soil, resulting in exposures. Surfaces that were made cleanable may deteriorate or may not be kept clean, allowing leaded dust to re-accumulate to hazardous levels. Nevertheless, abatement constitutes the most extensive and protective intervention currently available. If practiced properly, abatement will greatly reduce the risk of lead poisoning.

II. Building Component Replacement

Building component replacement is defined as the removal of doors, windows, trim, and other building items that contain lead-based paint hazards and their replacement with new lead-free components. Component replacement is the most desirable abatement method because it offers a permanent solution to the lead-based paint problem for the particular component(s); but it may not be feasible for all of the LBP present. If done properly, it also minimizes contamination of the property and exposure of the workers. In addition, building component replacement can be integrated into general building rehabilitation activities. Components, such as doors and windows, should be replaced with more energy efficient models, which will help to reduce energy consumption and increase cost efficiency. In some cases, component replacement may cost less than abatement, especially when ongoing maintenance and energy costs are considered. Component replacement may be more expensive, however, especially for historic preservation projects, as new building components that match the originals may have to be custom made. For some historic preservation projects, replacement may not be permitted (see Chapter 18).

The skills required to perform building component replacement properly are similar to those of the skilled carpenter. For example, it is important to know how the various building components were joined so that they can be taken apart with minimal contamination and damage to adjoining surfaces.

The owner may choose to simply remove certain types of components without replacement. This is acceptable as long as applicable codes are observed. HUD does not recommend reinstalling salvaged building components containing lead-based paint in other properties unless the lead-based paint is removed.

A. Worksite Preparation

The appropriate worksite preparation level should be selected based on the size of the building component, its state of deterioration, and the ease of removal. The more deteriorated the component and the larger the surface area to be disturbed, the higher the worksite preparation level should be. Certified risk assessors or certified abatement supervisors or trained project designers may determine the appropriate worksite preparation for a project (see Chapter 8).

1. Security

Security of the premises is an important issue. If windows and doors are removed but not replaced on the same day, it may be necessary to install temporary barriers over window and door openings to prevent vandalism and theft over night. Therefore, every effort should be made to remove and replace doors and windows on the same day.

Table 12.2 Comparison of Lead-Based Paint Abatement, Component Removal and Enclosure

Attributes	Abatement and Removal					Enclosure				
	HEPA Needle Gun	Heat Gun	HEPA Sanding	Remove/ Replace	Caustic Paste/ Solvent	Off-site Stripping	Plywood Paneling	Gypsum	Prefab Metal	Wood, Metal, Vinyl Siding
Skill Level	High	Moderate	Moderate	High	Moderate	Moderate	Moderate	Moderate	High	Moderate
Aesthetics (1)	Erodes surface	Gouges	Gouges/ roughens	Good	Gouges	Good	Good	Good	Good	Good
Applicability	Very low, limited to metal and masonry	Wide, can damage some components	Low, limited by surface contour	Wide, dependent on skill	Wide, can damage some components	Low, components only	Wide, walls	Wide, walls and ceilings	Varied, limited by components	Wide, walls
Lead Presence	Largely removed	Largely removed	Largely removed	Removed	Largely removed	Largely removed	Remains	Remains	Remains	Remains
Generation of Hazardous Waste (2)	Low to moderate	Low to moderate	Low to moderate	Low	High	High, but maintained off-site	Low	Low	Low	Low
Weather Limitations	Moderate	High	Moderate	Minimal	High	None	Minimal	Minimal	Minimal	Minimal
Applicable to Friction Surface	Some	Yes	Some	Yes	Yes	Yes	No	No	Yes	No
Surface Speed of Methodology	Slow	Slow	Slow	Moderate	Slow	Can be slow, requires coordination	Moderate	Moderate	Moderate	Moderate
Training Required	High	Moderate	Moderate	High	Moderate	Moderate	High	High	High	High
Capital Required	High	Low	Moderate	Moderate	Low	Low	Low	Low	High	Moderate
Worker Protection Required (3)	High	High	High	Moderate	High	Moderate	Low	Moderate	Low	Low
Finish Work Required	Tentatively	Moderate	Moderate	Low	Moderate	Moderate	Wide	Wide	Limited	Wide
Product Availability	Limited	Moderate	Limited	Wide	Moderate	Limited	Moderate	Moderate	Wide	Wide
Durability	Long	Long	Long	Long	Long	Long	Moderate	Moderate	Moderate	Moderate
Labor Intensity	High	High	High	High	High	Moderate	High	High	High	High
Overall Safety (3)	Moderate	Moderate	Moderate	Very high	Moderate	High	High	High	High	High
Surface Preparation	None	None	None	None	Minimal-adjacent areas	Minimal-hardware removal	Minimal	Minimal	Minimal	Minimal
Cost	High	High	High	High	High	High	Moderate	Moderate	High	Moderate

Notes: (1) – The degree of damage to the surface will depend on the expertise of the operator.

(2) – Concentrated lead-based paint waste or sludges from paint removal using caustic or organic solvent removers have to be TCLP tested to determine if they are hazardous waste. See Chapter 10.

(3) – Any construction work involves increased safety risks.

2. Planning for Waste Storage

While most lead hazard control work in housing is exempt from hazardous waste regulation, discarded architectural components must still be properly managed (see Chapter 10). All building components coated with lead-based paint should be stored in a secure, locked area, as should all lead-contaminated waste until it is disposed of. They should not be sold or released to anyone who might reinstall them in another dwelling unless all of the lead-based paint is removed first. Therefore, it is important to identify where waste will be stored and how it will be secured during the project. (See Section II.D, Transportation and Storage of Waste, below.)

B. General Procedures for Building Component Replacement

- ◆ Using a garden sprayer or atomizer, lightly mist the component to be removed with water to help keep the dust down during the removal process. Before applying the water, be sure there are no electrical circuits inside the component. (If electrical circuits are present inside the component, they must be turned off and disconnected before removal. No water mist should be applied even if electrical circuits are turned off or de-energized.)
- ◆ Using a utility knife or other sharp instrument, carefully score all affected painted seams. This will provide space for a pry instrument and will minimize paint chipping and dust generation during removal.
- ◆ Remove any screws or other fasteners. Using a flat pry instrument and a hammer, carefully pry the affected building component away from the surface to which it is attached. The pry bar should be inserted into the seam at the nail (or other fastening device) at one end of the component and pressure applied. This process should be repeated at other fastening locations until the end of the component is reached. The component will be removed intact and chip and dust generation will be minimized when prying is done this way. A pry point pad or softener may be required to minimize damage to adjoining substrates. Wider replacement trim can sometimes be used to cover adjacent area damage.
- ◆ As there is often a considerable amount of leaded-dust underneath or behind the component being removed, begin cleanup immediately after the individual component has been removed.
- ◆ Carefully remove or bend back all nails (or other fastening devices) and wrap the component in durable, puncture-resistant plastic sheeting and seal with duct tape. Wrapping components in plastic may not be necessary if the dwelling is vacant and if the truck and the pathway to the truck are lined with plastic. Use a vacuum to remove any dust that may have accumulated behind the components as soon as they have been removed. Vacuuming may be performed by another person while the removal is underway. Preparing the area for the new component (e.g., squaring, reducing, or enlarging openings) may also release accumulated dust that should be removed. Dispose of wrapped components properly.
- ◆ Bring new lead-free components into the work area only after all dust-generating activity is complete and the dust has been cleaned up by at least one vacuuming.

C. Removal and Replacement Procedures for Specific Components

1. Baseboards, Casings, and Other Trim

The term “other trim” applies to such components as window casings, interior sills (stools), aprons, door casings, baseboards (including caps and shoe moldings), chair rails, exterior fascia, soffits, shutters, and crown moldings (see Figure 12.1). Components with lead-based paint should be removed as described in the previous section.



FIGURE 12.1 Removing and Replacing Trim: interior (left), exterior (right).

New lead-free components should be installed in a professional manner using standard carpentry practices. In situations where trim is being applied to lead-based painted walls, ceilings and floors that were enclosed, or casings for windows or doors where the jambs have been enclosed, the trim should be back-caulked before installation as an added precaution. Back-caulking refers to the application of caulk to the perimeter of the back-side of rigid building materials to seal them before installation, preventing leaded-dust from entering the living space through cracks and crevices. Use a high quality caulk that is warranted for at least 20 years.

2. Windows

The term “window” applies to the sash, the stop and parting beads, window jambs, door frame and trim. Affected components should be removed as described in Section B. Window replacement can involve the removal of a wooden or metal unit and the installation of a wood, vinyl, or metal unit in its place (see Figure 12.2 and 12.3). If the jamb is not removed, it can often be enclosed by the new window frame system, which should be caulked and fastened. The remaining exterior portion of the jamb, if any, can be wrapped with coil stock (aluminum or vinyl or equivalent) after back-caulking. In situations where window units must be replaced in kind (e.g., historic preservation), the jambs should be removed and replaced also to make sure that no friction surfaces coated with lead-based paint remain. Generally, friction surfaces should not be painted.



FIGURE 12.2 Protecting the interior of a unit for exterior window abatement.



FIGURE 12.3 Replacement window system.

Depending on the building construction, it may be possible to remove the entire window system. The new lead-free components should be installed in a professional manner using standard carpentry practices. Windows may be replaced from the interior or exterior of the property. If windows are replaced from the exterior and only exterior clearance is planned, the interior of the unit must be protected by polyethylene sheeting.

3. Interior and Exterior Doors

Interior and exterior doors include the doorstops, door jambs and door frame (see Figure 12.4). Affected components should be removed as described above. Typical door replacement usually involves the removal of a wooden unit and the installation of a pre-hung wooden unit in its place. In this type of door replacement, the jamb is rarely removed, but is usually saved and enclosed with the new doorjamb after back-caulking. Wooden jamb extensions or coil stock, properly back-caulked, can be used to enclose any remaining portion of the jamb. In situations where pre-hung door units are not permissible (e.g., code requirements, historic preservation regulations), the original jamb should also be removed and replaced, if possible, to make sure that no friction surfaces coated with lead-based paint remain. If the jamb cannot be replaced, the stop should be removed and replaced with new material after the old jamb is carefully stripped.

Primers on Metal Components

In regard to whether lead-containing primers applied at the factory to metal doors, door frames, railings and other metal building components could create a hazard to people, if it can be determined that the lead on metal doors and frames resides only in the primers, and that the primers were factory applied and are in sound condition, then the primers themselves need not be abated or removed. This is an exception to the general lead hazard control requirement. However, finish coats of paint that cumulatively contain lead of 1 milligram per square centimeter or greater, or the alternative standard of 0.5 percent by weight or greater, are treated as lead-based paint. If laboratory analyses of samples of the field-applied finishes are negative (no lead-based paint), the metal doors and frames do not require abatement but should be



FIGURE 12.4 Pre-and post-abatement interior doors.

monitored to ensure that the lead-bearing primer does not become defective. If the base metal is exposed while sampling the field-applied finish paint, then the existence of a permanent bond cannot be assumed and the entire sample should be analyzed for presence of lead. Any damage to the primer resulting from sample collection should be repaired immediately in a manner that restores the integrity of the primer coat.

For the metal doors and frames under this exception, primers should be intact and doors should be operating properly, free from impact or abrasion between moving parts that will damage any surfaces. If this exception for factory-applied primers is used, risk assessors should advise property owners or building managers of the importance of continued

monitoring of the paint surfaces to ensure that subsequent surface deterioration or other factors do not result in exposing defective lead-based paint surfaces (the primers). Under this exception, property owners or building managers must commit to a plan for ongoing monitoring of the condition of the painted surfaces. The subsequent appearance of rust indicates a failure of the paint and primer, and the component must be abated.

Although unlikely, adhesion of the primer could be a problem. A simple “x” cut or crosshatch test will show if this is a problem. If adhesion is poor, the paint will tend to flake away from a cut. An adhesion test should also give an indication of the number of coats; color of finish versus primer (which would be orange if pigmented with red lead or bright colors such as yellow if pigmented with lead chromate); and thickness of layers. Of course, other colors of lead-based paint may also be present. Any damage resulting from an adhesion test should be repaired immediately in a manner that restores the integrity of the primer and finish coats to prevent subsequent deterioration.

When it can be determined that lead-based paint is present in a field-applied coating over an intact factory-applied primer, and paint removal is the abatement method of choice, only the field-applied finish coatings need to be removed. An intact primer need not be removed.

4. Kitchen and Bathroom Cabinets

Old lead-based painted kitchen and bathroom cabinets can be removed and replaced. Affected cabinets should be removed as described above. Lead-based paint on walls to which cabinets are attached should not be disturbed during cabinet removal. Applying masking tape around the cabinet perimeter and vacuuming immediately after removal will help to control leaded-dust.

5. Railings

Railings include the railing caps, banisters, posts and spindles (balusters), and newel posts that can be removed and replaced (see Figure 12.5). Railings may or may not be part of a stair system. Affected components should be removed as described in Section B. New lead-free components should be installed in a professional manner using standard carpentry practices. Metal railings and other grillwork can be removed and taken off-site for contained abrasive blasting or other forms of paint removal, then reinstalled after repainting. See Section II.C.3, above, regarding lead-containing factory-applied primers.

6. Exterior Siding

Many materials are used on a dwelling's exterior walls. Materials of concern are generally painted wood or brick. Under most conditions, deteriorated siding identified as a lead hazard will be abated through enclosure without removing the original material. However, in restoration or historically significant projects, it may be replaced. Siding is now available that closely resembles wood. If the siding is to be replaced, the affected siding should be removed. Care must be taken to avoid contamination of soil walkways, window air conditioners, and the building interior (see Figures 12.6 and 12.7).



FIGURE 12.5 A metal railing before abatement.



FIGURE 12.6 Installation of replacement siding.



FIGURE 12.7 Certified workers are needed to replace siding when the project's intent is lead abatement.

7. Interior Walls

If abatement is performed along with gut rehabilitation, old lead-based painted interior walls and ceilings may be removed and replaced. This activity, unlike those previously described, is more like demolition work. In addition to the layers of heavy duty plastic used to protect the floors from contamination, sheets of plywood should be placed over the plastic to protect it from damage during aggressive demolition, and to make cleanup of debris easier. Prior to demolition, affected areas should be sprayed lightly with water. Workers should wear ribbed rubber boots when walking on slippery, wet plastic. If ladders must be used, the plastic should be punctured to provide secure anchoring of the footings to the surface underneath. Ladder footings should not be placed on top of the plastic because this will create a slip hazard. Excessive water should not be applied, and the creation of puddles and streams that may flow through breaks or gaps in the containment should be prevented.

Removing plaster walls as a means to remove all of the old lead-based paint generates a great deal of dust. Unless this is required as part of a renovation occurring at the time of the abatement, the option of enclosure should be considered when determining abatement strategies.

D. Transportation and Storage of Waste

Building component replacement and demolition generate a considerable amount of waste material. Lead-contaminated building components and demolition debris should be handled carefully (see Chapter 10). Bulk debris such as doors, windows, and trim should be wrapped in durable puncture resistant plastic sheeting and sealed with tape. Smaller debris should be swept into heavy duty plastic bags after spraying. Exterior ground surfaces must also be protected. Outside storage needs to be secure and protect the ground (see Figure 12.8)

All debris should be removed from the site as soon as possible. In larger jobs where a dumpster is being used, it may be possible to eliminate the wrapping and bagging of bulk debris as long as the dumpster has a lockable lid and is lined with plastic and secured with a fence and signs.



FIGURE 12.8 Line surfaces with plastic in the work area (left) and pathways (right)

Contaminated building components and demolition debris should be transported in covered vehicles to an appropriate disposal facility. Old building components coated with lead-based paint should not be recycled unless the paint is removed beforehand. See Chapter 10 for a full discussion of waste disposal.

III. Enclosure Methods

A. Definition

Enclosure is the installation of a rigid, durable barrier that is mechanically attached to building components, with all edges and seams sealed with caulk or other sealant. Surfaces with lead-based paint are enclosed to prevent access and exposure and to provide a dust-tight system. Unlike encapsulation, the enclosure system is not dependent on the painted surface of the substrate for its durability. Enclosures should have a design life of at least 20 years. While adhesives are frequently used for initial mounting purposes and for assistance in covering the lead-based painted surface with the enclosure material, it is primarily mechanical fasteners that give enclosures their longevity.

Standard construction materials are employed to create a solid and relatively rigid end product (see Appendix 7.2 for a description of materials commonly employed for lead-based paint enclosure). The primary differences between enclosure for lead-based paint and ordinary construction include careful sealing of all edges, joints, and seams to create a dust-tight (not necessarily air-tight) enclosure; site containment; worker safety (particularly during any needed surface or substrate repairs); and special cleanup. There is generally little or no hazardous waste disposal and little degradation of the lead-based paint as part of the enclosure process, unless substrate repairs are necessary. The hazard and expense of removing deteriorated paint can be avoided when the enclosure material is mounted flush to a structurally sound lead-based painted substrate and all the seams are sealed. This method produces little leaded-dust (HUD, 1991). These advantages hold down labor costs compared to paint removal and building component replacement, although cleanup and clearance are still required. A lower level of containment can often be used as less dust is generated.

For broad surfaces such as walls, ceilings, floors, and siding, enclosure is often considerably cheaper and less hazardous than building component replacement and paint removal. However, enclosure does not remove lead-based paint from the property; instead, it makes the dwelling lead-safe.

B. Longevity of Enclosures

There is little doubt that hurricanes, earthquakes, tornados, and flooding can substantially compromise an enclosure's viability. Less dramatic but more common events can also increase the risk of lead exposure, such as damage to the enclosure by the occupant or water damage from a leaking roof, overflowing tubs, or broken pipes. Any type of enclosure is potentially vulnerable to water damage. Future occupants can also be threatened by remodeling endeavors that break through the enclosure.

1. Labeling of Surfaces to be Enclosed

A few simple procedures should be followed to promote lead safety in case an enclosure is breached. The surface to be enclosed should be labeled with a warning, "Danger: Lead-Based

Paint.” The label, spray-paint, or stamp lettering should be in permanent ink.

A durable drawing of the property floor plan should be mounted on a sturdy metal or wood base and affixed with screws to a wall in the utility room next to the electrical panel or at any other closet location that can be easily seen by maintenance personnel (see Figure 12.9). The drawing should be covered with plastic for protection. Enclosures should be highlighted on the diagram and identified as hazardous. (For a multi-family property, another copy of the drawing should be maintained in the property management office’s file.)

2. Unsound Substrates

Any substrate material can be enclosed, including plaster, concrete block, brick, and concrete. All soft, moveable, or otherwise structurally unsound structural members should be repaired prior to enclosure if they are needed to support the enclosure. If repair is not feasible, then the defective area will need to be removed and enclosure will not be possible. Hazards associated with preparing the site for enclosure increase as more remedial work is needed. Structural repairs may require lead-based paint removal or component replacement, with all the accompanying safety protocols these practices entail. If the substrate is sound but the paint is deteriorating, stabilization or removal of deteriorated paint before the enclosure is installed should *not* be done because it will generate dust.

3. Ongoing Monitoring and Reevaluation

Because the building components used for enclosure may be impacted during building use, or may shift or deteriorate, the property owner or manager must arrange for regular monitoring

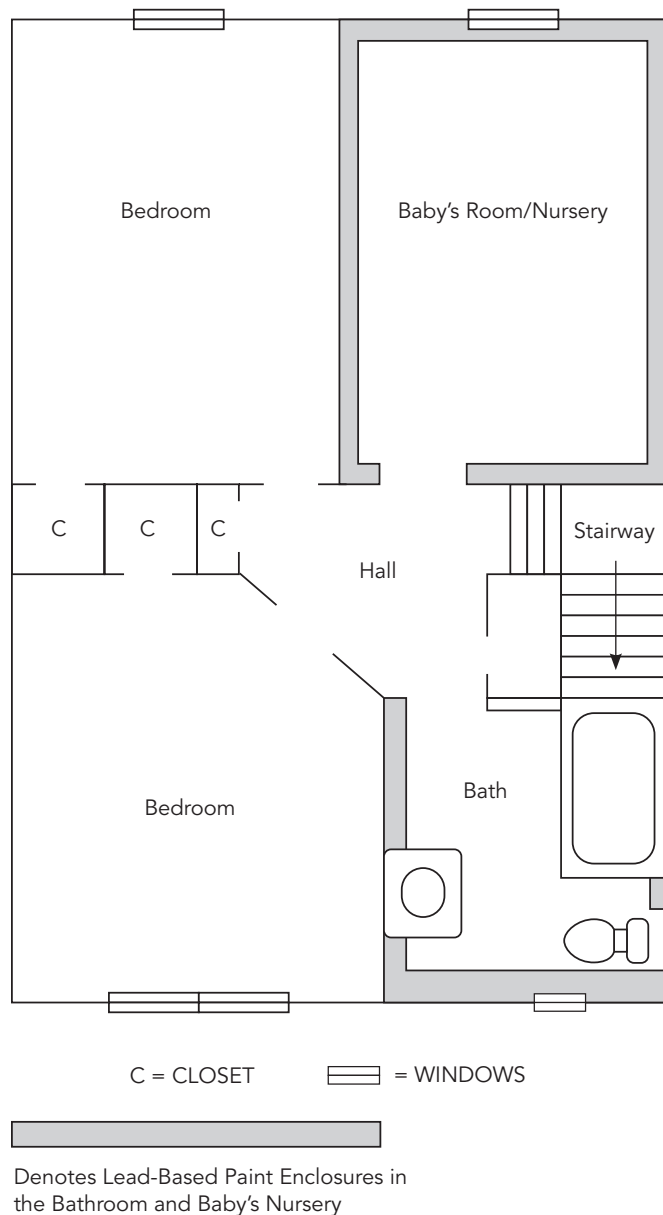


FIGURE 12.9 Example of a Diagram Showing the Location of Lead-Based Paint Enclosures.

and repairs, as needed. Visual monitoring should be performed no less often than every two years. If signs of wear or deterioration are apparent from visual assessments or other observations by maintenance and repair workers or during any reevaluation examination, the enclosure should be repaired using lead-safe work practices using a certified firm and workers, followed by clearance. In addition, residents should be instructed to notify management of the need for repairs on a timely basis. For HUD-assisted housing that is subject to periodic reevaluation, the monitoring of the performance of the enclosure should be part of that reevaluation to determine if deterioration or failure of the enclosure has occurred since the previous reevaluation.

C. Interior Surface Enclosure Materials

1. Wood Paneling

Wood paneling is an appropriate enclosure material, except for ceilings. It is of limited use, however, because of the difficulty of sealing seams around electrical outlets, switch boxes, and heating, ventilation, and air conditioning (HVAC) registers. There should be no gaps in the seams, outlets, boxes, and registers, which should all be screwed directly to the paneling and to any framing behind the panels. All seams should be caulked. Paneling made of composite board backing materials is vulnerable to dampness, particularly in below-grade situations such as basements. In some instances, the use of these materials may violate building and/or fire codes. On the other hand, plywood paneling may be stronger, more impact resistant, and more water resistant than other enclosure materials, such as drywall.

Paneling can be glued and mechanically fastened directly to the substrate, but the appearance is improved when the area to be covered is first furred or framed out and the paneling is anchored to these braces. The paneling should not extend past the depth of door or window frames or other trim pieces. Baseboards can be removed and the new cove base then glued directly to the paneling. Even heavy grades of paneling flex and vibrate when receiving mild impact. Over time, this could compromise the seal of the seams that join the paneling with other building components. Joints and edges must be fully supported; furring strips should be installed at the appropriate distance from each other, usually 12 inches apart. All seams at these transition points should be caulked before panel trim and corner moldings are installed as finish pieces.

2. Laminated Products

Laminated wall sheeting products, such as Marlite™, are designed to withstand surface moisture and are commonly used in bathrooms and kitchens. Their surfaces have a high sheen and clean easily. However, they may become defective when moisture gets behind the board's placement. This can occur from a leaking pipe or a seam opening in the bathtub/shower area. When a significant leak is detected, the enclosure must be reexamined.

3. Rigid Tile and Brick Veneers

Plastic and ceramic tile, synthetic brick and stone veneers, and other similar products are either glued or cemented directly to the painted surface. These products qualify as rigid encapsulants rather than enclosures because they are not mechanically fastened to the substrate. Regardless of whether they are enclosures or encapsulants, they tend to be inappropriate for broad application: The cost associated with labor and materials is often prohibitive for anything more than incidental use.

4. Drywall and Fiberboard

The steps to install drywall and fiberboard are shown in Table 12.3 and detailed specifications are provided by the Gypsum Association in Washington, DC (202-289-5440) Application and Finishing of Gypsum panel Products (GA-216-04). Available at <http://www.gypsum.org/download.html>.

Gypsum drywall or fiberboard is a very common and cost-effective interior finish. It is not difficult to locate skilled workers to install this product. Training materials are available from trade groups (Gypsum Association, 2004). When applied directly to a surface, the drywall is generally glued in place with construction adhesives and then mechanically fastened to the studs or structure behind the plaster. The screws must be long enough to go through the drywall, the plaster, and the wire mesh or lath and extend an inch into the stud or structure. To avoid having dust escape from the screw hole as the drilled screw displaces plaster, a dab of shaving cream can be applied to the area to be drilled.

Moisture-resistant greenboard should be installed in damp areas. It is difficult to completely control the long-term damaging effects of a severe moisture problem without invasive waterproofing and/or water diversion from the exterior of the property. Any type of enclosure is potentially vulnerable to water damage.

Table 12.3 Steps To Install Drywall and Fiberboard on Interior Walls.

- ◆ Check to make sure the depth of the trim will accommodate the thickness of the drywall (minimum of 3/8 inch preferred). If it does not, this method may not be suitable.
- ◆ Set up the plastic containment of the work area (see Chapter 8).
- ◆ Remove any trim being disposed of, and install the drywall over any cavity left by the removed moldings, except large cavities over 16 inches in any direction. Repair any structural deficiencies.
- ◆ Repair or remove any "soft" wall areas. Removal of painted plaster generates a great deal of leaded-dust.
- ◆ Use construction adhesive to glue the drywall directly to the surface being enclosed.
- ◆ Screw the drywall to the studs behind the existing wall. Caulk all seams that meet molding.
- ◆ Use extension rings to bring out electrical devices flush with the new gypsum based drywall and retrofit any HVAC registers. Caulk all seams.
- ◆ Tape and finish the drywall.
- ◆ Prime and paint the finished area, as well as the unenclosed surfaces in the same room so that all walls match the new installation. (See specifications and recommendations from the Gypsum Association.)

Quarter-inch thick drywall tends to conform to the contours and imperfections of the original substrate or wall, compromising the appearance of the finished product. To avoid this, use of 3/8-inch thick (minimum) drywall is recommended. The enclosed wall may in fact look much improved over the original wall. If the original wall surface is highly irregular, it may be necessary to install furring strips 12 inches apart and use 1/2-inch thick drywall to improve the appearance. If 1/4-inch thick drywall is used, it must be applied in accordance with the manufacturer's specifications (Gypsum Association, 2004).

D. Interior Building Components Suitable for Enclosures

All joints between drywall pieces should be taped and spackled with joint compound. Wherever the drywall meets wood framing or any other finish material (including electrical devices and HVAC registers), the seams should be sealed with a caulk or other sealant that has at least a 20 year warranty. Similarly, where sealed pipes penetrate an enclosure, the opening around the pipe must be sealed. Drywall is painted when installation is complete. Fastening schedules are available from industry trade groups (Gypsum Association, 2004).

1. Wood Trim and Drywall

The profile of the wood trim on windows and doors must be evaluated before overlaying an adjacent wall with drywall; the wall finish should protrude past the depth of the moldings. In homes built before 1960, this problem is less frequent because the trim tended to be more ornate and generally of thicker wood. Regardless of age, the problem is more likely to occur in multi-family public housing and institutional settings where the construction is basic and trim is thin.

If the drywall overlay is too thick, it may be possible to remove the baseboard and run the drywall to the floor. The baseboard can then be reinstalled over the new drywall (unless the baseboard itself presents a lead hazard, in which case it should be replaced). Obviously, care must be taken to avoid breaking the original baseboard during its removal. The seam at the bottom of the drywall should be sealed with caulk prior to the installation of the baseboard or cove base.

2. Electrical Outlets and Vents

All electrical devices, including switches and outlets, will need extension rings to bring those fixtures out flush with the new drywall overlay. A sealant or caulk should be used at cutouts for electrical boxes. Similarly, all grillwork at openings for heat vents and cold air returns should be retrofitted. These are minor but necessary steps in the drywall enclosure process.

3. Ceilings

Ceilings are more difficult to enclose than walls. Drywall applied directly to the ceiling will frequently result in an uneven appearance because there may not be a smooth transition from one board edge to the next. The solution is to draw a chalk line, usually every 16 inches on center, so that metal hat channels (or metal furring channels) or wood furring strips can be screwed into each ceiling joist. Three- to four-inch screws should be used to ensure that the screw penetrates the hat channel, plaster (or other substrate), and the wire mesh holding the plaster enough to bite firmly into the joist. The hat channel may be shimmed to get a perfectly level finished surface.

Next, the drywall should be affixed to the hat channel for an excellent finished product. An extension ring will be needed for ceiling light fixtures. Prior to lowering the ceiling slightly, the contractor should be confident that there is no interference with the top of ornate, oversized window frames, pipes, vent covers, or crown moldings. The overall height of the lowered ceiling should conform to building code clearances.

All screws for furring channels or strips must penetrate into the ceiling joists prior to installation of the drywall. On occasion, some multi-family housing or commercial buildings converted to residential use may have cast-in-place, reinforced concrete ceilings. Anchoring supports for the new ceiling may not be practical in these instances. Though this construction is generally very strong, a structural engineer should be consulted about attaching a drywall system to the concrete. On-site architectural or engineering advice is needed on a case-by-case basis to determine if this approach is appropriate.

Acoustical lay-in panels (drop-in ceilings) do not constitute lead-based paint enclosures; they will not adequately guard against the escape of leaded-dust into the living space and cannot be sealed.

4. Floors

Lead-based painted floors should be enclosed with 1/2-inch or thicker plywood or other underlayment (see Figure 12.10). The joints in underlayment should be flash patched. Shoe molding running along the baseboard should be removed before plywood installation and reinstalled when the finished floor is completely in place. If the shoe molding contains lead-based paint, new shoe molding should be installed since new molding is inexpensive and

more cost effective than removing the paint from the old shoe molding.

This will ensure that all floor covering runs tight to the baseboard and the joints at vertical surfaces are covered by the quarter-round molding. The plywood should be covered with vinyl tile or sheet goods to provide a cleanable surface. Covering the plywood with wall-to-wall carpeting is generally not recommended because the carpet does not provide a sealed top cover and is harder to clean. Vinyl floor coverings should be finished off with a metal threshold at all doorways or at any access to an uncovered open floor to protect the exposed edge. When placing tile over old flooring, a row of nails (preferably screws) should be run a few inches apart in a straight line over each joist before the plywood is put down. Old floor nails often lose much of their grip, which results in squeaky floorboards. This movement can in turn cause the edges of floor tile to lift in spite of the plywood underlayment that was installed. It is most important to remember that all the plywood sheets must be installed flush with each other. Gaps must be filled with flash patching cement. Also, a bead of caulk should be run at the edge of every board before it is set in place. All nails must be hammered flush and all dirt vacuumed thoroughly; otherwise small lumps will eventually appear in the soft vinyl finish goods.

If the floor to be enclosed is poured slab or cast-in-place concrete, the surface will have to be predrilled to accept each screw that anchors the plywood enclosure. A structural engineer should be consulted for

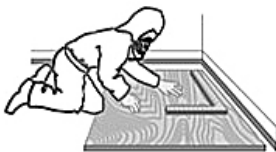
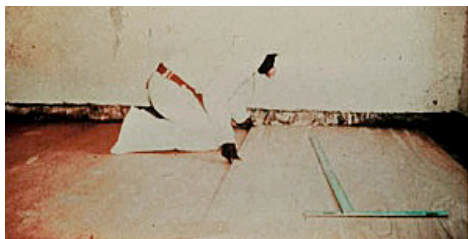


FIGURE 12.10 Install underlayment and new flooring as a suitable LBP enclosure method. The personal protective equipment is for a high-dust project.

situations other than slab-on-grade construction. Floor adhesive can offer an added measure of reinforcement and sealant. Each screwhead should be just below the level of the underlayment top surface and, along with the seams, should be covered with a smooth coat of flash patching cement to prevent dimples in the vinyl top cover.

5. Stairs

Dirt and loose paint should be removed prior to enclosure. Defective paint should be wet scraped and vacuumed; protective gear should be worn by the workers; and the work area should be contained with 6-mil plastic (or equivalent). In multi-family housing, common stairways must be accessible to residents and workers during the construction work to avoid a fire code violation.

Wooden steps with lead-based paint should be completely covered with vinyl or rubber treads and risers. These materials should have a minimum specification that would qualify for Federal Housing Administration (FHA) product approval or should be commercial grade. The vinyl should be stapled as well as glued with floor adhesive to avoid sagging. Long staples are preferred to reinforce the tread cover at this critical point and prevent the vinyl from being pulled up by the toe of a shoe. Metal bull nosing can also be used at this wear point.

In addition, long staples or metal bull nosing should be used at the end of the vinyl that butts up tight to the wood riser of the next step.

Plywood can be used to cover step risers and squared-off treads. Plywood is also useful as additional protection, supplementing the vinyl covers mentioned above. Precast concrete steps will have to be drilled, screwed, and glued to anchor the covers in place.

6. Pipes

Painted pipes can be enclosed with the same tape used to make plaster casts, which provides a hard-finished end product. Loose paint and dirt should be safely removed first. The wrapped tape should overlap itself so that it is not dependent on adhering to the painted surface.

Pipes can also be enclosed with drywall. However, this type of enclosure will insulate and limit the ability of radiator pipes carrying steam or hot water to contribute to household heating.

7. Door Frames

Preformed metal door buck or frame covers come in standard sizes to accommodate most components, and as such they can be used to enclose both wood and metal door frames, either interior or exterior. All seams must be caulked. Primers on such bucks should be lead-free.



FIGURE 12.11 Enclosed stairs.

8. Plywood Enclosures

Knee walls, painted structural supports, and trim such as baseboards, skirt boards, and stringers can be enclosed with plywood that is cut to fit tightly. These items should be sealed with adhesive and nailed. All joints should be caulked.

E. Exterior Enclosure Systems

1. Siding

Vinyl or aluminum siding may be used to enclose painted exterior surfaces. In addition, porch columns (both square and round) and porch ceilings can be enclosed with these materials. Aluminum coil stock can be used on soffits, fascia, bargeboard, decorative crown moldings (though original detailing will be lost), door and window frames, parapets, and other moldings. All seams need to be caulked and back-caulked. Soffit coverings under roof areas often need to be vented to prevent dry rot (see Figure 12.12). However, as old paint degrades behind this covering, a small amount may migrate through the vents. Breathable cloth materials such as Tyvek™ or an equivalent are available in rolls for this purpose and can be installed before the aluminum covering is put in place. The breathable cloth materials will help prevent leaded-dust from escaping through gaps in the new siding, although it will be necessary to leave attic vents

Create a dust-tight seal

Paint deteriorates more quickly behind an enclosure. All edges of an enclosure—especially the bottom—must be sealed well.

Seal the bottom edge

- ◆ Caulk the enclosure material at the bottom
- ◆ Back-caulk the nail and baseboard in place.
- ◆ Back-caulk, bottom-caulk, and nail the shoe molding in place.

Seal the seams and other edges

- ◆ Back-caulk all the seams that aren't taped and spackled. Use a high quality adhesive caulk.
- ◆ Use a "J-channel" where drywall meets a finished surface. A J-channel is a final strip attached to the rough edge of drywall to make a finished edge. It's called a "J-channel" because of its shape. Caulk the outside edge so it seals with the finished surface. Screw the drywall in place.

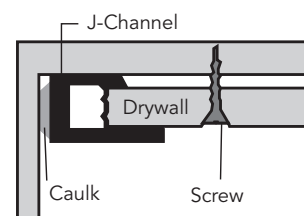
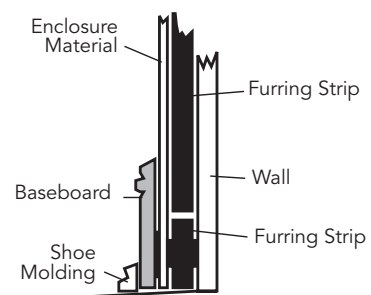
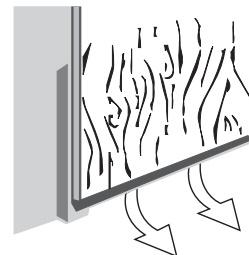


FIGURE 12.12 Seal All Seams for Enclosure.

uncovered to permit adequate ventilation. Vent openings should not be covered with Tyvek™ or other similar covering. Because siding may not provide an airtight enclosure, rigid or flexible dust barriers like Tyvek™ should be installed before broad surface enclosure. Perforated metal stock should not be used to enclose soffits, fascia, or eaves as the enclosure is not dust tight. Rotten or loose wood and any other defective substrate must be repaired or replaced to provide a sturdy foundation for the siding installation and edges.

2. Windows

For standard sized windows, snap-in replaceable aluminum and vinyl tracks are available. These devices help eliminate the painted friction point (and thus the generation of leaded-dust) where the moving sash abrades the painted surface. The track covers should be pressed into a bead of caulk at each joint. Painted sashes should be planed to remove lead-based paint and then reinstalled (see Chapter 11, Section IV). Friction surfaces on windows should not be painted.

Window troughs should be covered with fitted metal and screwed into place. Again, the metal should be pressed into a bead of caulk at the joints and edges.

3. Exterior Walls

Board products made of various materials (e.g., synthetic fiberboard, wood byproduct composites, and cementitious materials) are commonly used in the construction industry for exterior purposes. These heavy, sometimes brittle coverings often have resins, fiberglass, or other durable ingredients that make them resistant to weathering and may require little maintenance, including painting. An added benefit of using these products is that they may have thermal insulation value. The products are best installed over flat surfaces that are not soft, crumbling, unstable, or otherwise defective. A defective substrate must be repaired prior to enclosure. All joints need to be sealed after installation.

Properly installed, natural or synthetic brick and stone veneers can be used to enclose exterior walls. In addition, stucco can be used as a covering material using wire mesh to physically anchor the cement to solid building components. A defective, weak surface needs to be stabilized before covering. Vinyl and aluminum siding are usually the least expensive options.

F. Summary

Enclosures are solid materials that are physically anchored to building components and that cover lead-based paint. Enclosure usually involves common construction techniques and has a 20-year design life. The enclosure abatement option is an effective, stable remedy for minimizing the danger of lead-based paint exposure. Because any barrier can be breached, annual monitoring by the owner and reevaluation by a certified risk assessor or inspector technician are necessary.

Enclosure may be less hazardous and cheaper than paint and building component removal. There is less dust generated and little hazardous waste disposal. Unlike encapsulation, the enclosure is not dependent on the adhesion of the underlying coats of paint on the substrate surface for its durability, nor does it require deteriorated paint removal or surface cleaning and deglossing before installation.

Drywall is often a cost-effective interior finish, and aluminum or vinyl siding provides an acceptable exterior barrier. Aluminum coil stock is effective for enclosing outside trim. Floors require underlayment and vinyl or other sheet finish goods. Vinyl or rubber tread and riser coverings are recommended for steps.

IV. Paint Removal Methods

A. Introduction

Paint removal means the separation of the paint from the substrate using heat guns, chemicals, or certain contained abrasive measures, either on-site or off-site. As an abatement technique, paint removal is usually reserved for limited areas and for those surfaces where historic preservation requirements may apply.

While paint removal can be performed safely and effectively, it also demands the highest level of control and worker protection for several reasons. Paint removal usually creates the greatest hazard for the worker, either from the hazards associated with the removal process (e.g., heat, chemicals, and sharp tools) or from the lead that becomes airborne or is left as a residue on the surface after removal. On-site paint removal will usually be a high-dust job. Prepare the worksite in accordance with the guidance in Chapter 8. Lower levels are possible if the size of the area to be treated is small (see Chapter 8). Because of the lead residues left behind by all paint-removal methods, particularly on porous surfaces such as wood or masonry, more extensive cleaning is usually required to meet clearance criteria. Paint removal methods also generate a significant amount of waste and may be the most costly of all lead abatement methods (HUD, 1991).

All work involving lead-based paint should be performed in a manner that minimizes all dust production. All high-dust paint removal operations should be avoided, and all work be planned and designed to reduce all dust generation. Using work practices and procedures such as wet work practices and the use of tools with attached HEPA-vacuum exhaust will help protect children, workers and residents.

In spite of these limitations, paint removal has the benefit of a low reevaluation failure rate. If some lead-based paint is left in the dwelling, its condition will need to be monitored by the owner (see Chapter 6).

B. Prohibited Methods

Certain methods of lead-based paint removal are absolutely prohibited, either because of unacceptably high worker exposures to lead or release of lead into the environment through production of dust or fumes or both.

1. Open Flame Burning or Torching

Burning, torching, fossil fuel-powered heat plates, welding, cutting torches, and heat guns operating at temperatures greater than 1100°F are prohibited as a means of paint removal because of the high temperatures generated in the process. So-called heat plates (those using propane to heat a grid, which in turn heats the paint) are also prohibited because of the high temperatures generated. At these temperatures, lead fumes may be produced.

Lead fumes are formed when lead is heated into a gas. The gas cools when it comes into contact with the cooler surrounding air and condenses into very small particles. These particles travel easily, are readily inhaled and absorbed into the body, and are difficult to cleanup. Several researchers have found that worker exposures are extraordinarily high when doing this kind of work (NIOSH, 1992a; Jacobs, 1991b; Rekus, 1988). The fumes may also travel throughout the dwelling, contaminating all surfaces with which they come into contact. Other hazardous substances may be released from the paint film using heat.

Using cutting torches to remove fire escapes, railings, or other metal components coated with lead-based paint is also prohibited unless the paint is removed first. Similarly, welding of painted metal components (such as pre-primed structural steel) is prohibited by Occupational Safety and Health Administration (OSHA) regulations (29 CFR 1926.354(d)).

2. Machine Sanding or Grinding Without a HEPA Exhaust Tool

Machine sanding or grinding is prohibited (regardless of the grit used) because of the large volume of leaded-dust generated (see Figure 12.13). As a result of these methods, workers have been exposed to extremely high leaded-dust levels, and blood-lead levels in resident children have increased (Amitai, 1991; Farfel, 1990; Jacobs, 1991b). However, machine sanding with a HEPA abatement exhaust tool is permitted and is discussed further below. Extensive dry hand sanding is not recommended, but wet sanding can be done if no electrical outlets are nearby. Limited dry sanding or scraping near electrical circuits is permitted.

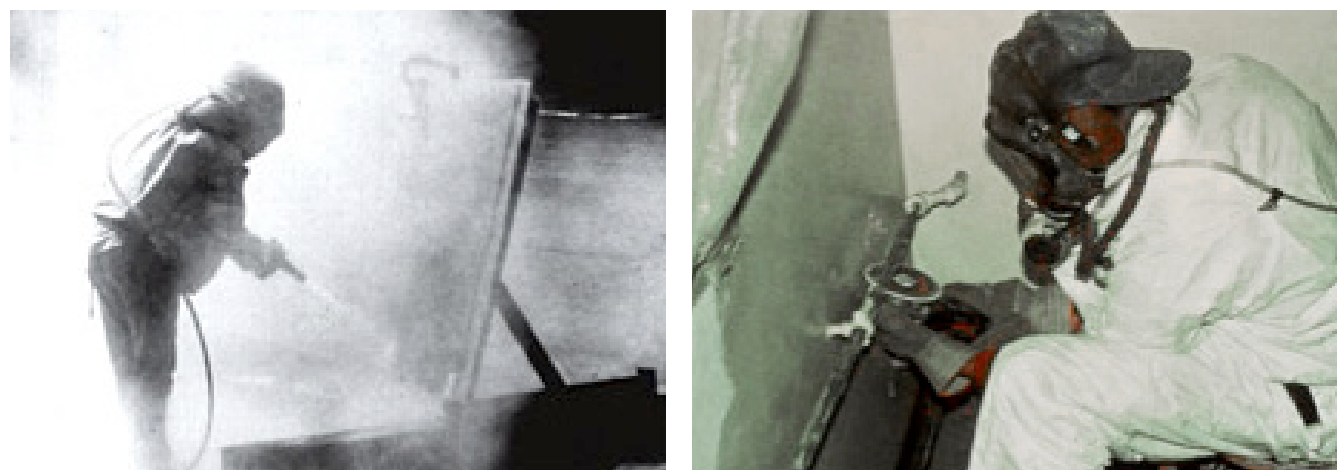


FIGURE 12.13 Prohibited work practices (traditional abrasive blasting (left) and grinding without HEPA exhaust).

3. Abrasive Blasting or Sandblasting

Traditional abrasive blasting or sandblasting is prohibited in residential structures, regardless of whether the abrasive material is recycled or if the area is fully contained. These methods produce widespread dust contamination; full containment is nearly impossible to maintain and guarantee in a residential environment. Abrasive blasting should only be done using HEPA vacuum local exhaust equipment, discussed below.

If abrasive blasting must be done in a residential structure, the area must be sealed and placed under negative pressure with enough clean fresh air so at least 10 times the volume of air in the contained space is brought in to the space and, after filtration, exhausted from it each hour (i.e., the ventilation rate is at least 10 air changes per hour) to ensure the dust can be controlled. If the exterior must be blasted, the entire building must be covered with a tent and placed under negative pressure with at least 10 air changes per hour. In both cases, all exhaust air must be passed through a HEPA filter. Fresh air should be provided to the containment zone at a lower rate than the exhaust airflow to maintain the negative pressure zone.

4. Heat Guns Above 1100° F

Heat guns operating above 1100° F or charring the paint should not be used. See discussion of operating heat guns below 1100° F in section IV.C below.

5. Dry Scraping

Dry scraping is not recommended because of the large volume of particulate matter that is generated (including high levels of leaded-dust).

The two situations where dry scraping is appropriate are scraping surfaces near electrical outlets, which cannot be wet scraped because of the obvious electrocution hazard, and scraping when using a heat gun as this cannot be done wet. For both of these cases, dry scraping is only appropriate for limited surface areas.

6. Chemical Paint Stripping in a Poorly Ventilated Space

Workers should not remove paint in poorly ventilated space when using a volatile stripper that is a hazardous substance in accordance with regulations of the Consumer Product Safety Commission (CPSC) at 16 CFR 1500.3 and/or a hazardous chemical in accordance with the OSHA regulations at 29 CFR 1910.1200 or 1926.59, as applicable to the work. (This practice is prohibited by HUD regulations but not explicitly by EPA regulations as of the publication of the second edition of these *Guidelines*.)

Paint strippers with methylene chloride should be avoided. OSHA has found that adults exposed to methylene chloride "are at increased risk of developing cancer, adverse effects on the heart, central nervous system and liver, and skin or eye irritation. Exposure may occur through inhalation, by absorption through the skin, or through contact with the skin." (62 FR 1493, January 10, 1997). OSHA's permissible exposure limit for methylene chloride in air was reduced in 1997 from 500 to 25 parts per million (29 CFR 1910.1052 for general industry, and the identical 29 CFR 1926.1152 for construction). Methylene chloride cannot be detected by odor at the permissible exposure limit, and organic vapor cartridge negative-pressure respirators are generally ineffective for personal protection against it.

Alternative paint strippers may be safer, but have their own safety and/or health concerns, so all paint strippers must be used carefully. Always follow precautions provided by the manufacturer. It is especially important that people who use paint strippers frequently not use such chemicals in a poorly ventilated area. If good ventilation is not possible, professionals equipped with protective equipment should perform the work in accordance with

CPSC regulations (16 CFR 1500.3) and/or OSHA's hazard communications standards (29 CFR 1910.1200 or 29 CFR 1926.59, which are identical) and with any substance-specific standards applicable to the work.

CPSC and EPA recommend that people who strip paint provide ventilation by opening all doors and windows and making sure there is fresh air movement throughout the room ("What You Should Know About Using Paint Strippers," CPSC Document 4423, and EPA Document EPA 747-F-95-002). (www.cpsc.gov/CPSCPUB/PUBS/423.html)

C. Recommended Methods of Paint Removal

1. Heat Guns

Open flame burning is prohibited, so removal methods using heat are limited to electric powered flameless heat guns (see Figure 12.14).

Before beginning work, fuses and an adequate electrical supply should be verified. Larger fuses should not be installed because of the possibility of creating a fire hazard. A portable electric generator may be needed, especially if several heat guns will be required. Care should be exercised around wallpaper, insulation, and other flammable materials. An accessible garden hose with a pressure-release spray nozzle, a crowbar to remove smoldering wood, and a long-handled sledgehammer to open up walls exposed to smoldering insulation should be readily available. Under OSHA regulations (29 CFR 1926.150), a fully charged ABC-type 20-pound (minimum) fire extinguisher must be available within 100 feet of the work area. Work should be conducted only in well-ventilated spaces. Other hazardous materials may be released when old painted surfaces are heated (NIOSH, 1992a).

While there is little risk that dangerous levels of lead fumes will be produced at temperatures below 1100°F, significant airborne particulate lead is generated by the accompanying scraping of the paint. Also, significant amounts of potentially harmful organic vapors can be released from the action of the heat upon the paint, even at temperatures below 1100 °F. For this reason, air-purifying respirators should be outfitted with both a HEPA-filtered cartridge and an organic vapor cartridge. Organic vapor cartridges may not be available for some powered air-purifying respirators.

Depending on the size of the area and the substrate, paint removal by heat gun can be a slow, labor-intensive process and may result in a high final clearance failure rate if used extensively and without proper cleanup. Removing paint completely, particularly from crevices, requires attention to detail. Significant leaded residue may remain on surfaces unless cleanup is thorough. Heat guns do not appear to be particularly effective on metal or masonry substrates, which are too porous to be scraped effectively; the heat may cause small particles to fly up and hit the worker, causing burns or eye damage. Although heat guns work well on wood, they will usually damage drywall and plaster.

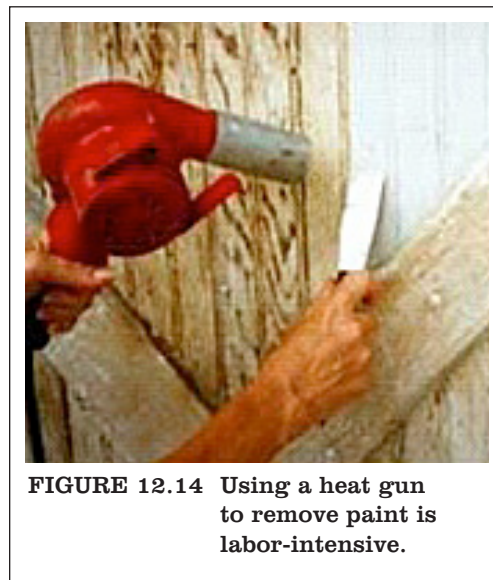


FIGURE 12.14 Using a heat gun to remove paint is labor-intensive.

Workers may tend to place the nozzle of the heat gun too close to the surface, burning out the heating elements prematurely, sometimes inadvertently even if they have been trained not to do so. One way to prevent this is to attach a small metal wire cage or extension tube to the end of the heat gun to prevent it from being placed too close. For most heat guns, the optimal distance from the surface is 3 to 6 inches. The heat gun is recommended only for limited surface areas in well-ventilated spaces. Other problems with heat guns include additional fire hazards from dry rot, insulation, and dust, especially in window troughs, roof areas, and hollow porch columns. Scraping often leaves the substrate very rough and may singe adjacent wallpaper. Telephone wires mounted on baseboards can melt, and heat can crack glass with a cold exterior or dry glazing.

To use heat guns properly, allow the heat stream leaving the gun to merely soften the paint. Do not allow the paint film to scorch or smoke. Scrape the loose paint off the surface at the very first sign of paint softening, blistering, or bubbling.

2. Mechanical Removal Methods

HEPA Sanding

HEPA sanders are valuable for surface preparation prior to repainting. As chemical stripping sometimes raises the grain of the wood and some removal methods are not effective at removing all visible traces of paint, some sanding prior to repainting may be needed. Manual sanding can generate significant levels of airborne and settled lead-dust; airborne levels more than 10 times OSHA's permissible exposure limit, have been observed (Zhu, 2012). Therefore, HEPA-assisted sanders are recommended whenever sanding must be done. HEPA sanders do not work well on detailed moldings. In such situations, chemical stripping, use of a heat gun or offsite removal may be suggested.

HEPA sanding uses traditional electric sanders, such as disc sanders or orbital or vibrating sanders, equipped with specially designed shrouds or containment systems that are placed under a partial vacuum (also known as local exhaust ventilation). All exhaust air is passed through a HEPA filter (often using an ordinary HEPA vacuum) to reduce the amount of airborne particulate lead (see Figure 12.15). The HEPA vacuum must be correctly sized to provide adequate airflow to permit the system to operate properly. If hoses are longer than normal, a larger HEPA vacuum may be needed to handle the increased pressure drop.

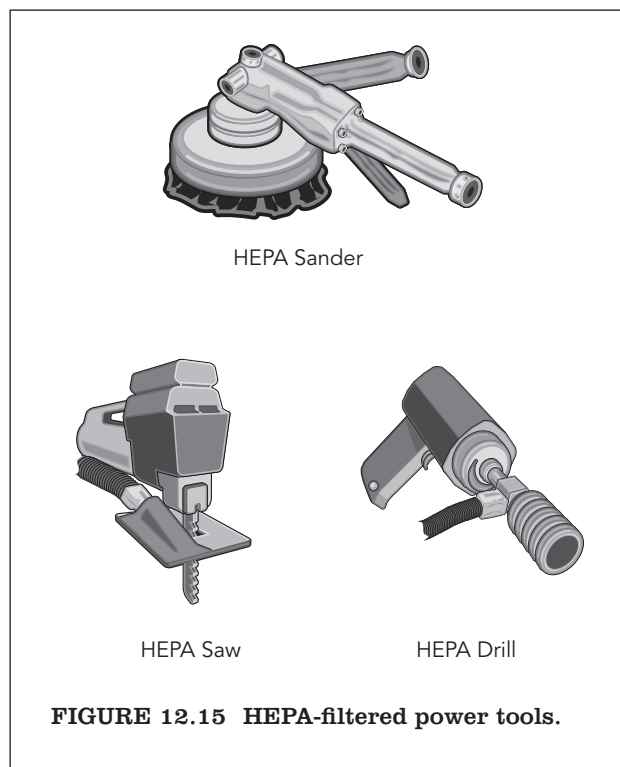


FIGURE 12.15 HEPA-filtered power tools.

There are two main types of HEPA sanders. The first uses a flexible shroud to surround the sanding head, with the HEPA vacuum hose attached to the shroud. The shroud must be in constant contact with the surface to be effective. If the shroud extends beyond the surface being sanded, large amounts of particulate lead will be released into the air. In addition, this configuration makes it impossible to sand to the edge of protruding surfaces, such as baseboards or window and door casings.

The second type of HEPA sander pierces the sandpaper with holes through which the vacuum draws the dust. This allows the instrument to be used to the edge of protruding surfaces. However, care must be exercised to keep the sandpaper flat on the surface. Neither one of these methods is completely effective; respirators are always recommended. Worker fatigue can also prevent the worker from holding the tool flush with the surface, making it necessary to provide frequent breaks or rotate workers.



FIGURE 12.16 Wet scraping (left)
FIGURE 12.17 Scraping tools (right).

Wet Scraping

Wet scraping is feasible on most surfaces and results in lower lead exposures than dry scraping. Since surfaces near electrical outlets should never be moistened (due to the electrocution hazard), these areas should be dry scraped.

Wet scraping can be performed by using a spray bottle or sponge attached to a paint scraper (see Figure 12.16 and 12.17). Wet scraping is often used to remove loose and flaking paint before paint film stabilization or encapsulation. If wet scraping is employed as an abatement technique, a more durable covering than new

paint is needed. Working a few square feet at a time, the worker should mist the surface lightly using a garden sprayer or plant mister. Loose material should be scraped from the surface and deposited on the containment plastic with a paint scraper. Damp paint chips should be cleaned up as soon as possible so that they are not tracked throughout the work area or crushed beneath the feet of workers.

Scraper blades should be kept sharp to minimize abrasion and gouging. Additional scraper blades should be on hand and should be selected for the type of surface being scraped. To obtain a smooth finish, it may be necessary to follow wet scraping with wet sanding. A variety of scraping tools are available from hardware and paint supply stores.

HEPA Vacuum Blasting

HEPA vacuum blasting is simply abrasive blasting with a shroud under a vacuum that is attached to the blast head. All exhaust air is passed through a HEPA filter, using a properly sized HEPA vacuum system. Vacuum blasting is appropriate for metal, brick, concrete, and



FIGURE 12.18 Vacuum blasting is not often used on housing.

other masonry surfaces. To date, attempts to use the process on wood, plaster, and other soft materials have not been successful, as they usually cause severe substrate damage.

Various blasting media can be used (e.g., aluminum oxide, metal shot, walnut shells) depending on the type of substrate. Blast heads, usually a brush-type arrangement, come in various sizes and shapes. The blast head must remain in continuous contact with the surface to avoid dispersal of both the blast medium and particulate lead (see figure 12.18). The equipment can be outfitted with a device that separates the blast media from the paint, effectively recycling the blast material, and dramatically reducing the volume of waste. This is particularly important because the blast material should be disposed of very carefully (see Chapter 10).



FIGURE 12.19 Needle Gun with HEPA Exhaust Ventilation.

Use of the equipment for long periods of time can result in worker fatigue, particularly if working with the arms above the head. Fatigue can cause a worker to momentarily lose contact with the surface, resulting in the release of leaded dust, so the goal is to minimize the degree to which workers must reach above their shoulders. Scaffolding and platforms should be constructed to minimize such stress, and frequent work breaks should be taken. Vacuum blasting is not typically used in interior residential work.

HEPA Vacuum Needle Gun

The HEPA vacuum needle gun is similar to vacuum blasting in concept but avoids the use of a blast medium (see Figure 12.19). In the vacuum needle gun, metal needles rapidly pound against the painted surface, dislodging the paint. The HEPA vacuum, which is connected to the gun head, draws paint chips and dust into the vacuum, minimizing the dispersion of the particulate.

The needle gun is appropriate for metal surfaces but may cause significant damage to masonry. Problems of worker fatigue are similar to those encountered in vacuum blasting. Losing shroud contact with the surface can cause the deposition of significant amounts of chips onto the containment surface. Chips should be cleaned up as soon as possible following the work to avoid tracking.

One way of maintaining the seal with the surface is to select the proper shroud for the shape of the surface treated. At least one manufacturer (Penntek) has developed different shrouds for corners, edges, and flat surfaces. Needle guns are not effective in capturing large paint chips, so use of plastic sheeting underneath is required.

3. Chemical Removal Methods

Chemical removal may result in less leaded dust generation than other removal methods. It is often used in situations where historic preservation requirements apply. However, it may leave leaded residues on porous surfaces, which may pose a hazard to resident children in the future.

One study has demonstrated that windows treated with chemical paint removers had high leaded-dust levels a few months after treatment, even though cleanup and clearance had been conducted properly (Farfel, 1992).

Other drawbacks to chemical removal include high cost and potential harm to workers from splashes and chemical burns if proper gloves, face shields, and clothing are not provided and used (see Figure 12.20).

Proper ventilation is necessary when using chemical paint removal. Plastic may not be effective in protecting floors and may have to be augmented by paper or cardboard. Chemical residues can be tracked into other areas on workers' shoes if proper decontamination is not conducted. Adjacent surfaces, especially plaster, can also be damaged. High humidity may retard the chemical remover's effectiveness. If protective clothing is penetrated and becomes matted against the skin, it must be removed *immediately*. A full shower is strongly recommended.

Off-site Paint Removal

Off-site paint removal is preferred so that most of the contamination and residues are generated away from the dwelling. The general approach is as follows.

Building components to be stripped must first be removed from the building. Misting with water prior to removal will help minimize the amount of airborne lead. The painted seam between the component and the wall should first be cut with a utility razor knife to minimize damage to the adjacent plaster. If there is more than one similar component, each component should be labeled to identify exactly where the component came from, eliminating the need for changing doors or other retrofitting problems.

Potential damage to components during stripping includes damage to hardware (this should be removed before stripping), broken glass, loss of glue joints and fillers, damage to wood fibers (wood swelling), and raising of the wood grain. The component may even fall apart and have to be blocked and re-glued. Old glazing compounds on windows may also be weakened. The stripping firm should be instructed to *thoroughly* wash and neutralize the components after stripping.

Before materials are returned from the paint stripper, they should be wrapped in heavy duty plastic and sealed with tape. This will minimize contamination of those handling the materials (leaded residue may remain on the surface). Materials should remain sealed until other on-site dust-generating activities are concluded and the dust cleaned up.

Before reinstallation, the treated components should be cleaned using the standard vacuum/wet clean/vacuum cycle to remove any residues left by the paint stripper. Components must



FIGURE 12.20 Workers should wear protective clothing when using chemicals.

be completely dry before repainting. Always check the pH (acidity or alkalinity) after cleaning and *before* repainting.

On-site Paint Removal

Many paint removers must be allowed to remain on the surface anywhere from 1 hour to a day or more to accomplish effective stripping.

Most paint removers are efficient within a limited temperature range and may be completely ineffective in cold weather. The contractor must therefore be certain of weather conditions before outdoor application. Also, rain or snow can cause environmental contamination from the lead and the chemical remover.

Paint removers are either caustic (corrosive) or non-caustic. The non-caustic chemical removers are generally safer to use than the caustic ones (assuming they do not contain methylene chloride). Material Safety Data Sheets should always be consulted to determine potential chemical hazards.

When using chemical strippers, securing the area where the strippers are used and the areas where they are stored is important, particularly with caustics, to prevent injuries to people who may gain access to the work area. Caustic paint removers can cause severe skin burn and eye damage to workers, other adults and children who may gain access to the work area. Pain receptors in the eyes are not as sensitive to caustic substances as they are to acids, so workers may suffer damage without immediately realizing it.

Personal protective equipment should be appropriate to the chemical paint stripping work being done; see Chapter 9, Worker Protection.

An abundant source of water within the abatement area for quick drenching or flushing injurious corrosive chemicals from skin or eyes is required by OSHA regulations (29 CFR 1910.151(c)). The water can come from a tap or portable eyewash station(s) (see Figure 12.21).

If contact with the eyes occurs, a full 15-minute rinse of the eyes is necessary *on-site before the individual leaves to seek medical attention* because permanent damage to the eyes occurs quickly. While 15 minutes may seem excessive, a quick rinse is ineffective, and permanent damage usually occurs on the way to seek medical attention.

Usually, non-caustic strippers are not as effective at removing multiple layers of paint in a single application compared to the caustic products. When using non-caustic removers, small areas should be tested before full-scale treatment to determine their efficacy. For vertical surfaces, adhesion of the liquid or gel type paint removers should also be tested to determine runoff potential (particularly a problem in warm weather). Most caustic paint removers work best on nonporous surfaces such as steel. They generally should not be used on aluminum or glass surfaces.

Paint removers that contain volatile substances should be used only in areas equipped with mechanical ventilation and only when workers are properly equipped with gloves, face shields, protective clothing, and respirators, as needed.



FIGURE 12.21 Eye- and body-wash stations are required when working with corrosive or irritant chemicals.

The paint remover should be applied with a spatula, trowel, brush, or spray gun. Spray gun use should be minimized because they increase worker exposures. The time the remover must stay on the surface will depend upon the number of layers of paint, the type of paint, the temperature, and the humidity, and can range from a few hours to a day or more. The paint remover should not be allowed to dry out. Some manufacturers provide a polyethylene or paper blanket that is pressed into the surface to retard drying; others contain a film that is formed on the surface of the paint remover as it sits to prevent drying. Caution must be used when applying the paint remover overhead to avoid its dripping onto workers below.

After the appropriate period of time, the softened paint should be removed using a scraper or putty knife and the material deposited in a watertight and corrosion-proof container (usually supplied by the manufacturer). The waste should be managed and disposed of in accordance with the guidance in Chapter 10.

With wood surfaces, it is important to complete the entire neutralization and cleaning process without letting the surface dry. If the wood dries before cleanup is complete, the pores in the wood may close, locking potentially significant leaded residues inside. When repainting, some of the leaded residue may leach into the new paint.

Alkali neutralization and residue removal are accomplished as follows. Immediately after paint removal (while wood surfaces are still damp), the surface should be thoroughly scrubbed with a solution of glacial acetic acid. Use of vinegar to neutralize the alkali should be avoided because vinegar may be inadequate as a neutralizing agent and will also result in a significantly larger volume of liquid (and potentially hazardous) waste.

Glacial acetic acid is hazardous and can cause skin burns and eye damage. It should be used carefully and only with neoprene, nitrile, rubber, or PVC gloves; chemical-resistant clothing; eye shields; a NIOSH-approved acid gas cartridge; and a HEPA filter on air-purifying respirators.

The damp, stripped surface should be thoroughly scrubbed with the acetic acid solution. The solution should be monitored with pH litmus paper and discarded if the pH exceeds 6. After use, the solution should be placed in corrosion proof containers and treated as potentially hazardous waste. Sponges and other cleaning materials should not be reused but deposited in heavy duty (double 4-mil, or single 6-mil) trash bags that are sealed, labeled, and put in a secure waste storage area.

Following neutralization, the damp surface should be thoroughly scrubbed with a detergent and water. Scrubbing should continue until no residues are visible. The cleaning solution should be changed when it becomes dirty. Following the detergent scrub, a clean water wash should be performed to remove residue. The pH of the water wash should be checked after use. If the pH exceeds 8, further neutralization of the surface with the acetic acid solution is necessary prior to repainting since an alkaline surface will cause the new paint to fail in a matter of days or weeks.

Surfaces should be completely dry before repainting. For wood surfaces, this may take several days to a week. If the moisture has raised the grain and sanding of wood surfaces is required before repainting, a HEPA sander should be used.

Since porous surfaces such as wood or masonry may still have slight alkali residues, some types of oil paints should not be used after caustic paint remover application. To do so may result in saponification (a “soap-making” reaction between the paint and the substrate, leading to rapid paint failure). Therefore, latex paints are probably most appropriate. Wood surfaces (especially exterior ones) can deteriorate after paint removers have been applied, making new paint difficult to apply. Also, the new paint may not last long on deteriorated substrates. Some old plasters with a high pH (that is, highly alkaline) may require primers that are no longer manufactured, so a special sealant may be needed on such surfaces. The specific paint remover manufacturer should be contacted for further guidance on appropriate paints to use.

High-pressure water removal of caustic paint removers should be avoided because control of solid and liquid contamination is difficult. Release of solids or liquids into the soil is likely to result in costly cleanup. Care must be used when applying caustic paint removers to friction surfaces, such as window jambs. Such surfaces are often weathered, making residue removal even more difficult. If these residues are embedded in a coat of new paint, the friction caused by opening and closing the windows can lead to the release of leaded-dust.

D. Waste Disposal

Wastes produced during paint removal may be highly concentrated, but low in volume. The toxic characteristic leaching procedure (TCLP) test should be used to determine if the waste is hazardous. See Chapter 10, Housing Waste, and the EPA regulations. Many local jurisdictions pick up small amounts of hazardous waste on certain days. If off-site paint removal is performed, the waste is the responsibility of the facility performing the removal.

V. Soil and Exterior Dust Abatement

A. Introduction

Lead-contaminated soil and exterior dust have been shown to cause elevations in blood-lead levels of children in a number of studies (EPA, 1993c). Exposure to lead in soil and exterior dust can occur both outside during play and inside from soil and dust carried into houses on shoes, clothing, pets, or by other means.

Soil can become contaminated over a period of years from the shedding of lead-based paint on nearby buildings, windblown leaded-dust from adjacent areas, and fallout of leaded-dust from the atmosphere (either from a local point source or from leaded gasoline emissions in the past). Uncontrolled paint removal from nearby houses or painted steel structures can also result in contaminated soil (controlling soil lead levels should be a consideration in every exterior lead-based paint abatement project).

Soil lead hazards are determined by measuring the concentration of lead in the soil, examining the location and use of the soil, and determining the degree to which the soil is “bare” (see Chapter 5). For a yard or area to require hazard control, a total of at least 9 square feet of bare soil must be present. Any size bare area in a play area containing more than 400 µg/g of lead is a hazard. Appendix 13.3 contains details on a sampling method to measure lead in soil. When assessing the condition of the surface cover, it is important to determine why the soil is bare. Bare soil is common in the following areas and circumstances:

- ◆ Heavily used play areas.
- ◆ Pathways.
- ◆ Areas shaded by trees or buildings.
- ◆ Areas with damaged grass.
- ◆ Drought conditions.

Measuring the lead content of soil will aid in the selection of an appropriate abatement method that has a reasonable likelihood of being maintained. Soil *abatement* (as opposed to interim controls) is generally appropriate when lead is present in extraordinarily high concentrations (more than 5,000 µg/g), use patterns indicate exposures are likely, or interim controls are likely to be ineffective (e.g., planting grass in high-traffic areas). Soil interim controls are covered in Chapter 11, Section VI. This section describes soil treatments that should be effective for at least 20 years.

Pre-abatement soil samples should be collected but not necessarily analyzed until post-abatement soil samples have been collected, analyzed, and compared to clearance standards. If post-abatement soil levels are below applicable limits, the pre-abatement samples need not be analyzed (see Chapter 15).

B. Soil Abatement Methods

Soil abatement methods include:

- ◆ Soil removal and replacement followed by off-site or on-site disposal; including covering with clean soil (Mielke, 2006; Mielke, 2011).
- ◆ Soil cultivation (rototilling).
- ◆ Soil treatment (e.g., organic matter, chemical, phytoremediation) and replacement.
- ◆ Paving with concrete or asphalt.

Soil removal is discussed in detail below; however, before choosing to remove contaminated soil, other treatment options should be considered. The advantages of using soil treatment methods (as opposed to soil removal) are three-fold (Elias, 1988):

- ◆ The costs of hauling large quantities of contaminated soil are eliminated or greatly reduced.
- ◆ Disposal sites for soil are not needed except for a much smaller volume of wastes generated during the treatment process.
- ◆ The need for uncontaminated replacement soil is greatly reduced.

1. Soil Removal and Replacement

For most soil removal projects, removal of 6 inches of topsoil is adequate. The depth of soil lead contamination is usually restricted to the top of the soil, with contamination decreasing markedly below the top few inches. However, in urban areas it is not uncommon for the contamination to extend to up to 1 or 2 feet in depth. This may be because these areas were

once the location of buildings contaminated with lead-based paint. Alternatively, past practices may have resulted in a gradual buildup of the elevation of the soil grade over time. In such circumstances, the removal of the top layer of soil may leave behind contaminated soil at lower depths. In mixed residential/ industrial areas, or where industry once existed, the depth of the contamination may vary widely. The desired decision on the depth of removal should also consider the depth of soil disturbance during the course of usual activities, such as gardening. If the top layer of soil will not be penetrated, then it should not be necessary to remove lead-contaminated soil at deeper levels, since there will be no exposure.

For practical purposes, properly conducted soil removal to a depth of 6 inches should suffice in urban residential areas that are restricted to grass, shrubs, or shallow gardens. However, the depth of soil contamination should be assessed at each site, and the decision regarding depth should be made based on the results of the soil sampling and anticipated use of the land. For most residential areas, the depth of removal will not exceed 6 inches (Jones, 1987; Ontario, 1987; Stokes, 1987 and 1988). Records of the soil sampling and abatement that occurs should be maintained with the permanent records of the property. These records will alert property owners who are planning excavations to depths below the abatement depth, such as for water or sewer line work, to use caution to avoid contaminating the surface soil with excavated soil. The owners should be advised to sample the soil below the abatement depth to determine the lead concentrations so that procedures can be implemented to segregate this deeper soil, if contaminated, and to use it as fill for the deeper areas of the excavation when the work is completed. With EPA's standard for the maximum allowable lead concentration in replacement soil being that it is less than 400 $\mu\text{g/g}$, the lead concentration in the replacement soil must be less than that concentration; it is advisable that, where feasible, it be half or less than that, i.e., 200 $\mu\text{g/g}$ or less, to provide a precautionary safety factor.

- 1. Types of Equipment** – Removal and replacement of soil in residential abatement situations may take place in both large and small sites. Some urban yards are very small, consisting of only a few square feet; others are larger, but are sometimes surrounded by buildings. Therefore, residential soil abatement will often require the use of extensive manual labor in addition to mechanical soil removal. When soil is removed by hand, it generally can be loaded into wheelbarrows and then off-loaded to other vehicles to be transported to the disposal site. Rather than off-load the wheelbarrows to dump trucks, it is usually more efficient to dump the soil directly into roll off containers, which are then loaded onto trucks for transport to the disposal site.
- 2. Sod and Seeded Grass Maintenance** – All grass sod planted as part of the abatement process should be maintained until the end of the growing season. This maintenance should include initial frequent watering to establish the rooting of the sod and germination of the grass seed, followed by watering on a regular basis to keep the grass in a healthy state. Under some conditions, seeding the soil may be practical, but often it is not realistic to restrict use of the soil area for the length of time needed to establish newly seeded grass.
- 3. Identify Utilities** – The owner or contractor should contact the local coordinated information source for all utilities before beginning work to obtain exact locations of all underground utility lines. If a utilities information service does not exist in the community, the individual utilities should be contacted directly. In addition, the Common Ground Alliance's (CGA's) One Call Systems International committee maintains an 811 telephone number which will notify local

utility companies about the intent to dig so that, within a few days, they can “send a locator to mark the approximate location of your underground lines, pipes and cables, so you’ll know what’s below – and be able to dig safely” (<http://www.call811.com/how-811-works/default.aspx>). CGA also maintains an on-line interactive map (<http://www.cga-onecall.com/map/>) and a state-by-state listing (<http://www.call811.com/state-specific.aspx>) of contact information for “one call” centers for each U.S. state and Canadian province that should be able to help with finding underground service lines.

4. **Protect Utilities** – Care should be taken to protect existing utilities during abatement to prevent any damage to existing underground and overhead utilities and to prevent any harm to human life and property. If a contractor is used, the owner should require the contractor to protect the existing utilities and to make good any damage to these utilities as quickly as possible.
5. **Existing Fences** – Care should be taken while removing existing fencing for worksite access. Such fencing should be salvaged and reinstalled (if it does not contain lead-based paint) to the satisfaction of the owner. In some cases, fencing may have to be replaced.
6. **Protection of Adjacent Areas** – When working adjacent to excluded areas, including sidewalks, fences, trees, and patios, the soil should be excavated at a slope away from the excluded areas of less than 2 percent so that contamination does not wash or roll into the excluded area.
7. **Inclement Weather** – Removal and/or replacement operations should be suspended at any time when satisfactory control of the overall operation cannot be maintained on account of rain, wind, or other unsatisfactory weather or ground conditions. Determination of such conditions should be made by the owner or project consultant. When such conditions exist, the work area should be cleaned up immediately and work suspended. High winds can disperse contaminated soil and dust to off-site areas and runoff from rain can carry contamination outside the abatement area.
8. **Vehicle Operation** – Prior to hauling contaminated soil, a vehicle operation plan should be prepared for the equipment and hauling vehicle operators, which includes but is not limited to information on the cleaning of vehicles, securing of tarps and tailgates, ticketing of trucks, unloading of material, and handling of spilled soil.

All trucks, hauling vehicles, and containers loaded with contaminated soil should be inspected for loose material adhering to the outside of the body, chassis, or tires before departure from the worksite. Such material should be cleaned up before the vehicle leaves for the disposal site. If the truck tires made contact with the contaminated soil, they should be cleaned before the trucks leave the work area. The tires should be brushed off on a plastic sheet and the contaminated soil loaded onto the truck or returned to the lot being excavated.

Soil should be loaded directly into dump trucks or disposal containers from the worksite. If possible, there should be no “double-handling” of contaminated material, such as shoveling the soil into a wheelbarrow, moving it to another location, dumping it, and shoveling it again into another container. This double handling not only wastes time but also increases the likelihood of spreading the contamination and tends to make site cleanup more difficult. The trucks should have secure fitting tarps and sealed tailgates to reduce leakage as much as possible.



FIGURE 12.22 Replacing resident pathway after soil removal.

- 9. Soil Replacement and Cleanup** – Prior to soil replacement, all walks, driveways, lanes, and streets adjacent to the excavation area should be cleaned of all contaminated soil (see Figure 12.22). All loose soil should be scraped, washed, and swept from the above-mentioned surfaces. No clean soil should be placed down until all contamination has been removed from these areas.

At the completion of the workday, all loose contaminated soil within the limits of the work area should be collected. The collected soil should be transferred to a dump truck or other container for subsequent disposal.

All hard surfaces, such as sidewalks, paved driveways, and patios, should be cleaned at the completion of each workday. This daily cleanup should consist of scraping, washing, vacuuming, and wet sweeping all soil from the above-mentioned surfaces.

Cleanup procedures should begin early enough so that they can be completed before the end of the workday.

- 10. Prevention of Contamination from Underlying Soil** – Regardless of the depth of removal, the possibility of contamination of the replacement soil from the underlying unexcavated soil exists, particularly from future activities. One way to minimize this occurrence is by laying a water-permeable fabric (geotextile) or similar lining at the bottom of the excavated areas to provide a visual demarcation between replaced soil and original soil (Weitzman, 1993). This liner can serve as a warning for persons digging in the future to exercise caution so that contaminated soil beneath the liner does not become mixed with the replacement soil.
- 11. Contaminated Soil Load Manifest System** – In order to keep track of the contaminated soil being hauled away from the site, a load manifest system should be used to keep an exact record of the time and location of disposal. The manifest should consist of a two-part ticket, with one ticket given to the owner at the time of truck departure and the other held by the hauler. The disposal site ticket should be presented to the site owner or inspector technician before the end of the workday on which the material was deposited in the dump site. The purpose of the manifest system is to ensure that the contaminated soil is not used as fill in other residential areas. Soil waste should be managed and disposed of carefully; it may be considered hazardous as a result of a TCLP test (see Chapter 10, Housing Waste).
- 12. Final Grade** – The final grades of replaced soil should be 2 inches above existing grades to allow for settling and to ensure that all drainage is away from existing structures.
- 13. Existing Vegetation** – A number of precautions are needed to protect existing vegetation, such as bushes and trees. It is advisable to tie trees and shrubs to ensure stability. Hand tools are needed to scrape soil from around roots without undermining or damaging them. Any large roots should be left undisturbed.

14. Tool Contamination – To minimize the cross-contamination between excavation and replacement worksites, separate tools should be provided for the excavation and replacement activities. A less-expensive alternative is to employ an acceptable method for decontamination of tools, workers' clothing, and footwear. The decontamination should include physically removing as much soil as possible and then washing and rinsing the contaminated items with water.

All workers should clean their boots thoroughly before leaving the work area. The soil removed from boots should be disposed of either in a truck used for hauling contaminated soil or left in the worksite.

15. Prevention of Off-site Movement of Contaminated Soil – Contaminated soil should be removed from the site as soon as possible to prevent wind and water erosion. To prevent off-site migration and to avoid the possibility of tampering by children, piles of contaminated soil should not be left on-site overnight. Wind erosion can occur on any site. Water erosion is more likely on hilly sites or during heavy precipitation. Exposed sites can be covered with plastic and secured in place to prevent off-site migration of contaminated soil. An alternative method is to wet down the site at the end of the workday to prevent wind erosion. Similar problems will be encountered when contaminated soil is stockpiled during the day prior to disposal at the end of the day. In this case, wind and water erosion should be controlled by using a combination of plastic sheeting and silt fencing.

16. Site Control – The following precautions should be taken:

- ✦ To prevent the spread of contaminated soil, secure working limits should be defined for each area of excavation. Access to this area should be restricted to authorized personnel with entrances and exits controlled.
- ✦ The abatement work area should be enclosed with temporary fencing or adequate barricades to prevent unauthorized personnel or animals from entering the work area.
- ✦ Yellow caution tape should be installed across doors leading to abatement areas.
- ✦ Access routes to homes should be maintained at all times. Such routes should not require passing through the area of excavation.
- ✦ The removal of a partial grass cover in preparation for the laying of sod or grass seeding may *temporarily* increase the amount of bare contaminated soil. On-site exposure could result when children play on the exposed soil. Abatement workers can control this during the day by means of adequate site control. However, control is difficult, if not impossible, after the end of the workday. Lead hazard warning signs should be posted to warn residents.
- ✦ In order to minimize inconvenience to residents and neighbors and to minimize exposure, abatement of a particular site should be completed within 1 workday.

2. Soil Cultivation

Soil lead concentration often decreases with increasing depth, so soil mixing can be considered to be an abatement strategy. If the average lead concentration of the soil to be abated is below 1,200 $\mu\text{g/g}$, thorough mixing is an adequate abatement method. Pilot testing may be necessary to determine the type of mixing process needed. Rototilling may not be effective.

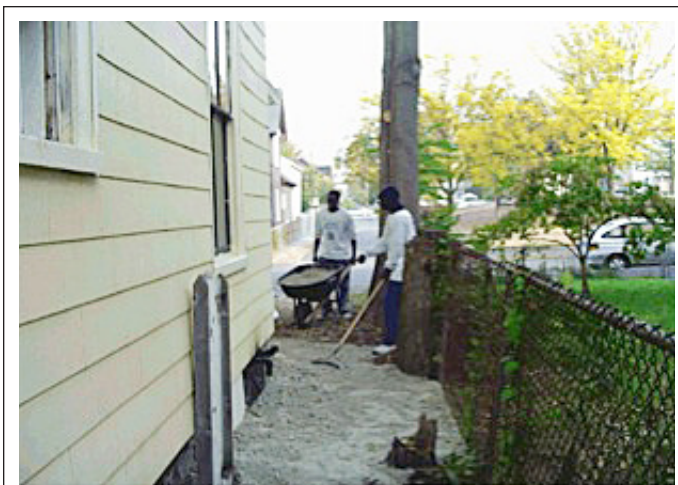


FIGURE 12.23 Preparing to pave high traffic area.

3. Paving

If contaminated soil is present in high-traffic areas, the soil can be covered by a high-quality concrete or asphalt (see Figure 12.23). In this case, contaminated soil need not be removed before paving. Normal precautions associated with thermal expansion or contraction and traffic load should be considered. Hard surfaces are not appropriate in play areas where falls are possible from slides, jungle gyms, etc. The Consumer Product Safety Commission has developed recommendations for fall surfaces in public play areas (e.g., addressing the need for impact attenuating protective surfacing under and around equipment, installation and maintenance procedures, and general hazards presented by protrusions, etc. CPSC, 2008; www.cpsc.gov/CPSCPUB/PUBS/325.pdf).

4. Other Soil Treatment Methods Under Study

HUD has funded studies to investigate other potential methods to reduce soil lead hazards. Plants can reduce the soil lead level (phytoremediation) but their use has not been widely tested or applied. The use of chemical additives (e.g. phosphate) to reduce the biological availability of lead appears to be attractive, but studies are continuing.

C. Exterior Dust Control

Lead in exterior dust can be a source of exposure to children because it can be tracked inside and carried on the skin, especially the hands (Bornschein, 1986). For example, in older urban areas in Cincinnati, exterior leaded-dust concentrations are on average about four times higher than interior leaded-dust concentrations, and exterior lead surface loadings are much higher than for interior dust (Clark, 1993). Just as children can be directly exposed to leaded-soil, they can also be exposed to exterior leaded-dust. Exterior dust can also migrate by various means (children, adults, pets, or wind) to the interior of homes where there are many opportunities for exposure to children. Exterior leaded-dust concentrations up to 50,000 $\mu\text{g/g}$ (equivalent to 5 percent lead in dust) have been measured in urban areas in the EPA Soil Lead Abatement Demonstration Project (EPA, 1993c).

If only an individual property is involved in the exterior dust-control activity, the type of equipment that can be used will be limited by the size of the area involved and the person responsible for the area. Owners are not required to clean streets, for example. Because of the mobility of exterior dust, the length of time that the dust cleanup remains effective will be limited by the size of the abatement area and therefore may need to be repeated periodically.

Exterior dust control consists of two components:

- ◆ Controlling sources of lead-contaminated dust.
- ◆ Removing lead-contaminated dust from paved areas.

Without adequate control of the sources of lead in exterior dust, recontamination of the exterior areas will occur. Studies of a schoolyard area indicated that leaded-dust concentrations equaled pre-abatement levels within 1 year in Winnipeg, Ontario (Stokes, 1988). Recontamination of some paved areas in Cincinnati occurred within a few days (Clark, 1991), indicating that repeated cleaning and control of the *sources* of the lead are necessary.

1. Types of Equipment

Exterior dust cleanup consists of removing as much dust and dirt as possible from all paved surfaces on the property or properties involved. Lead-contaminated dust can be found on paved surfaces such as sidewalks, patios, driveways, and parking areas. For multiple adjacent properties that are being abated, cleanup of streets, alleys, or other common areas should be considered, although this is normally a municipal responsibility. Brick paved areas present the biggest challenge in removing exterior dust because they contain numerous cracks. For individual properties, hosing off walkways and play areas periodically may reduce exterior leaded-dust levels.

In order to meet this cleaning challenge, it is necessary to have available the most efficient hard-surface vacuum cleaning equipment. Many commercial contract cleaning firms located in urban areas have such equipment.

There are several different types of suitable paved-surface cleaning machines:

- ◆ Hand-pushed vacuum cleaners.
- ◆ Vacuum-assisted sweepers, which are similar to the traditional broom sweeper, with the added feature of a slight vacuum that assists in controlling dust and transporting material from the broom bristles to the hopper.
- ◆ Vacuum sweepers, which lift material from paved surfaces – some are equipped with curb brushes to assist in transporting the material from the edge of the cleaning area to the vacuum head and into the hopper.
- ◆ Trucks equipped with strong vacuums and large HEPA filters for the exhaust.

EPA research has found that regenerative air machines, which depend on rapidly moving air to capture particles from the surface of the pavement, frequently remove only a small fraction of the dust and thus may not be suitable for lead abatement work (Pitt, 1985).

2. Evaluation of Equipment

A number of pavement-cleaning machines were tested as part of the Cincinnati Soil Lead Abatement Demonstration Project (Clark, 1993). The machines tested were the vacuum-assisted sweeper, the vacuum sweeper, and the regenerative air machine. Initial tests demonstrated that several machines operated above the 90 percent efficiency level. A machine performing at the 90 percent efficiency level will pick up 90 percent of the available dirt after two passes. Equipment tested involved both large machines suitable for streets and parking lots and some walk-behind, vacuum-assisted broom sweepers suitable for sidewalks and other smaller areas. Several larger machines performed at or above the 90 percent efficiency rate. Some of the smaller walk behind sweepers did not perform at an acceptable level of efficiency.

Care must be taken when emptying the collected dust from the machines. The most appropriate method to minimize dust release is to dampen the contents of the hopper using an accessible hose. If water is to be used for dust control, it will be necessary to devise a means of containing excess water. This can be achieved by placing 6-mil polyethylene plastic on the ground where the equipment is being emptied and carefully collecting the water after the hopper has been emptied. It is also necessary to perform this activity in a secure area so that children are not exposed.

3. Removal of Heavy Accumulation

The first step in cleaning an area should be the removal of heavy accumulations of dust and debris. The heavily accumulated areas can be cleaned either by manually removing the material with scrapers, shovels, or brooms, or by vacuuming the heavily accumulated areas if vacuuming proves to be adequate in removing the contamination. Just as in handling lead-contaminated soil, the heavy accumulations of exterior dust should be dampened.

4. Vacuum Cleaning

Small areas, such as sidewalks and patios that are inaccessible to larger cleaning machines, may be cleaned with an acceptable vacuum cleaner (see Chapter 14 for discussion of vacuum cleaners). Surfaces should be vacuumed continuously until no additional visible dust is being removed by further vacuuming.

References

- Amitai, 1987. Amitai, Y., J.W. Graef, M.J. Brown, R.S. Gerstle, N. Kahn, and P.E. Cochrane. "Hazards Of 'Deleading' Homes Of Children With Poisoning," *American Journal of Diseases of Children*, 141: 758-760.
- Amitai, 1991. Amitai, Y., M.J. Brown, J.W. Graef, and E. Cosgrove. "Residential Deleading: Effects on the Blood Lead Levels of Lead Poisoned Children," *Pediatrics*, 88(5): 893–897.
- Bornschein, 1986. Bornschein, R.L., P.A. Succop, K.M. Krafft, C.S. Clark, B. Peace, and P.B. Hammond, "Exterior Surface Dust Lead, Interior House Dust Lead, and Childhood Lead Exposure in an Urban Environment," in *Trace Substances in Environmental Health II*, ed., D.D. Hemphill, University of Missouri, Columbia, Missouri.
- Chisolm, 1985. Chisolm, J.J., E.D. Mellits, and S.A. Quaskey, "The Relationship Between the Level of Lead Absorption in Children and the Age, Type, and Condition of Housing," *Environmental Research* 38: 31–45.
- City of Toronto, 1990. City of Toronto Department of Public Health in conjunction with Ontario Ministry of the Environment, *Lead Reduction Program House Dust Cleaning: Final Report*, Concord Scientific Corporation and Gore & Storrie Limited in association with South Riverdale Community Health Centre, Toronto, Montreal, Canada.
- Clark, 1991. Clark, C.S., R. Bornschein, P. Succop, S. Roda, and B. Peace, "Urban Lead Exposures of Children in Cincinnati, Ohio," *Journal of Chemical Speciation and Bioavailability*, 3(3/4): 163–171.
- Clark, 1993. Clark, C.S., R.L. Bornschein, J. Grote, W. Menrath, W. Pan, S. Roda, and P. Succop. *Cincinnati Soil Lead Abatement Demonstration Project Final Report*, August 1993.
- CPSC, 2008. Consumer Product Safety Commission, *Handbook for Public Playground Safety, Recommendations for Surfacing Materials*, Washington, DC, 1991 revised 2008. www.cpsc.gov/CPSCPUB/PUBS/325.pdf
- DOE 2002, Weatherization Program Notice 02-6, Effective Date – July 12, 2002, http://www.waptac.org/data/files/technical_tools/wpn02-6.pdf
- Elias, 1988. Elias, R.W., "Soil-Lead Abatement Overview: Alternatives to Soil Replacement," in *Lead in Soil: Issues and Guidelines*, eds. B.E. Davies and B.G. Wixson, Science Reviews Ltd., Northwood, Canada, pp. 301–305.
- EPA, 1990b. U.S. Environmental Protection Agency, "Soil Washing Treatment," *Engineering Bulletin*, Office of Research and Development, EPA/540/2–90/017, Cincinnati, Ohio, 1990.
- EPA, 1992a. U.S. Environmental Protection Agency, *Training Course for Lead-Based Paint Abatement Project Supervisors*, Washington, DC.
- EPA, 1992b. U.S. Environmental Protection Agency, *Environmental Equity: Reducing Risk for All Communities*, Report to the Administrator from the EPA Environmental Equity Workgroup, Office of Policy, Planning, and Evaluation (PM–221), 230–DR–92–002, Washington, DC.

EPA, 1993c. U.S. Environmental Protection Agency, Environmental Criteria and Assessment Office, *Urban Soil Lead Abatement Demonstration Project*, Integrated Report, 600/AP-93-001, Research Triangle Park, North Carolina.

Farfel and Chisolm, 1990. Farfel, M., and J.J. Chisolm, Jr., "Health and Environmental Outcomes of Traditional and Modified Practices for Abatement of Residential Lead-Based Paint," *American Journal of Public Health*, 80(10):1240-1245.

Farfel, 1992. Farfel, M., Paper presented at Centers for Disease Control Conference, December 8, 1992.

Farfel, 1994a. Farfel, M., Briefing at EPA headquarters, Washington, DC, February 1994.

Farfel, 1994b. Farfel, M., J.J. Chisolm, Jr., C.A. Rhode, "The Long-Term Effectiveness of Residential Lead Paint Abatement," *Environmental Research*, 66: 217-221.

Gypsum Association, Application And Finishing Of Gypsum Panel Products, GA-216-2004, June, 2004. Available at www.gypsum.org/download.html

HUD, 1991. U.S. Department of Housing and Urban Development, *The HUD Lead-Based Paint Abatement Demonstration (Federal Housing Administration)*, prepared by Dewberry & Davis, HC-5831, Washington, DC.

HUD, 1999, Lead-Safe Housing Rule, 24 CFR 35, Regulation on Lead-Based Paint Hazards in Federally Owned Housing and Housing Receiving Federal Assistance.

Jacobs, 1991b. Jacobs, D.E., "A Review of Occupational Exposures to Lead in Residential Renovation and Structural Steel Demolition Work," delivered before EPA Lead in Adults Symposium, Durham, North Carolina, December 10, 1991, and submitted for publication to *Environmental Research* in 2004.

Jacobs, 1993a. Jacobs, D.E., "Lead-Based Paint Abatement in Murphy Homes," Georgia Institute of Technology Report for the Macon Housing Authority, Macon, Georgia, (unpublished data).

Jones, 1987. Jones, A.R., *South Riverdale Soil Lead Levels: An Explanation for the Recontamination of Some Residential Properties in the Vicinity of Canada Metals Co., Ltd.*, Technical Report, Ontario Ministry of the Environment—Central Region, Toronto, Canada, 1987.

Mielke, 2006, Mielke, H.W., Powell, E.T., Gonzales, C.R., Mielke, P.W., Jr., Ottesen, R.T., Langedal M. 2006. New Orleans Soil Lead (Pb) Cleanup Using Mississippi River Alluvium: Need, Feasibility and Cost, *Environmental Science and Technology* 40(08):2784-9. DOI 03/10/2006

Mielke, 2011, Mielke, H.W., Covington, T.P., Mielke P.W., Jr. Wolman, F.J., Powell E.T., Gonzales, C.R. 2011. Soil intervention as a strategy for lead exposure prevention: The New Orleans lead-safe childcare playground project. *Environ. Poll.* 159: 2071-2077. doi:10.1016/j.envpol.2010.11.008.

NIOSH, 1992a. National Institute for Occupational Safety and Health, *Health Hazard Evaluation Report, HUD Lead Based Paint Abatement Demonstration Project*, Centers for Disease Control, , DHHS Publication No. 90-070-2181, U.S. Department of Health and Human Services, Cincinnati, Ohio.

Pitt, 1985. Pitt, R., *Characterizing and Controlling Urban Runoff Through Street and Sewerage Cleaning*, EPA Document No. EPA/600/52-85/038, U.S. Environmental Protection Agency, Washington, DC, June 1985.

Rabinowitz, 1985a. Rabinowitz, M., A. Leviton, and D. Bellinger, "Home Refinishing, Lead Paint, and Infant Blood Lead Levels," *American Journal of Public Health*, 75(4): 403–404.

Rekus, 1988. Rekus, J.F., "Structural Steel Hot Work: A Serious Lead Hazard in Construction," *Welding Journal*, September 1988: 25–32.

Staes, 1994. Staes, C., T. Matte, C.G. Copley, D. Flanders, and F. Binder, "Retrospective Study of the Impact of Lead-Based Paint Hazard Remediation on Children's Blood Lead Levels in St. Louis," *American Journal of Epidemiology*, 139(10): 1016-26

Staes, 1995. Staes C., and Rinehart R., "Does Residential Lead-Based Paint Hazard Control Work? A Review of the Scientific Evidence." National Center for Healthy Housing, Columbia, Maryland.

Stokes, 1988. Stokes, P., "Canadian Case Studies and Perspectives," in *Lead in Soil: Issues and Guidelines*, eds. B.E. Davies and B.G. Wixson, Science Reviews Ltd., Northwood, Canada, pp. 7–25.

Weitzman, 1993. Weitzman, M., A. Aschengrau, D. Bellinger, and R. Jones, "Lead Contaminated Soil Abatement and Urban Children's Blood Lead Levels," *Journal of the American Medical Association*, 269(13): 1647–1654.

Zhu, 2012. Zhu, J., Franko, E., Pavelchak, N., and DePersis, R., "Worker Lead Poisoning during Renovation of a Historic Hotel Reveals Limitations of the OSHA Lead in Construction Standard," *Journal of Occupational and Environmental Hygiene*, DOI:10.1080/15459624.2012.700273, Accepted author version posted online: 07 Jun 2012.

Chapter 13: Abatement by Encapsulation

HOW TO DO IT	13-3
I. Introduction	13-5
A. Definition	13-5
B. Standards and Acceptance	13-5
C. Background	13-6
II. Assessment of Surfaces and Components for Suitability	13-7
A. Specific Surfaces and Components Not Suitable for Encapsulation	13-8
B. All Other Surfaces	13-9
III. Encapsulant Classification	13-10
IV. Minimum Performance Requirements for Encapsulants	13-10
A. Safe Application	13-11
B. Adhesion	13-11
C. Ability To Remain Intact	13-11
1. Mechanical Properties	13-11
2. Chemical Resistance Properties	13-12
3. Durability	13-12
D. Fire, Health, and Environmental Requirements	13-12
V. Factors to Consider in Selecting and Using Encapsulant Systems	13-12
A. Base Substrate	13-12
B. Lead-Based Paint Film Properties	13-13
C. Application and Installation Constraints	13-13
1. Skill Level	13-13
2. Method and Environmental Conditions	13-13
3. Regulations	13-14
D. Environmental Service Conditions	13-14
E. Use Conditions	13-14
F. Encapsulant Service Life	13-15
G. Safety Constraints and Information	13-15
H. Aesthetics	13-15
I. Repairability	13-16
J. Cost	13-16
K. Technical Assistance	13-16
VI. Specific Encapsulant Products and Surface Preparation Procedure	13-16
A. Encapsulant Product Selection	13-16
B. Surface Preparation	13-17
1. Cleaning	13-17

2. Deglossing	13-17
3. Removal of Loose Paint	13-17
4. Preparing Exposed Base Substrates	13-17
C. Field Patch Tests	13-18
1. Size of Patch Tests	13-18
2. Location of Patches	13-18
3. Surface Preparation for Patch Testing	13-18
4. Encapsulant Application and Installation	13-18
5. Patch Preparation for Conducting a Lead-Based Paint Soundness Test	13-19
6. Visual and Adhesive Evaluation of Field Patch Tests	13-19
7. Documentation of Patch Test Results	13-21
VII. Application and Installation of the Encapsulation Systems	13-21
A. Surface Preparation for Job	13-21
B. Installation and Application of Encapsulant System	13-22
1. Non-reinforced and Reinforced Coatings	13-22
2. Adhesively Bonded Coverings	13-24
C. Inspection of Encapsulant Systems	13-25
1. Tools	13-25
2. Procedures	13-25
VIII. Ongoing Monitoring and Reevaluation	13-26
IX. Recordkeeping	13-26
REFERENCES	13-28
FIGURES	
Figure 13.1 Encapsulating a floor with vinyl tiles	13-8
Figure 13.2 Deteriorated paint on surfaces that are unsuitable for encapsulation.....	13-8
Figure 13.3 Encapsulated historic components.	13-13
Figure 13.4 Encapsulant failure.	13-21
FORMS	
Form 13.1 Encapsulant Patch Test Documentation.....	13-23
Form 13.2 Lead-Based Paint Encapsulation Visual Monitoring Form.....	13-27
TABLES	
Table 13.1 Advantages and Disadvantages of Using Encapsulants.....	13-7
Table 13.2 Categories of Encapsulants.....	13-10
Table 13.3 Steps for Obtaining Proper Application and Installation of an Encapsulant System.....	13-22

Chapter 13: Abatement by Encapsulation

How To Do It

1. **Determine if encapsulants can be used. Do not encapsulate the following surfaces:**
 - a. Friction surfaces, such as window jambs and doorjambs.
 - b. Surfaces that fail patch tests.
 - c. Surfaces with substrates or existing coatings that have a high level of deterioration.
 - d. Surfaces in which there is a known incompatibility between two existing paint layers.
 - e. Surfaces that cannot support the additional weight stress of encapsulation due to existing paint thickness.
 - f. Metal surfaces that are prone to rust or corrosion.
2. **Conduct field tests of surfaces to be encapsulated for paint film integrity.**
3. **Consider special use and environmental requirements** (e.g., abrasion resistance and ability to span base substrate cracks).
4. **Examine encapsulant performance test data supplied by the manufacturer.**
5. **Conduct at least one test patch on each type of building component where encapsulant will be used.**
6. **Prepare the surface in the manner selected for the complete job.** For both non-reinforced and reinforced coatings, use a 6- by 6-inch test patch area. Prepared surfaces for patch testing should be at least 2 inches larger in each direction than the patch area.
7. **Use a 3- by 3-inch patch for fiber-reinforced wall coverings.** For rigid coatings that cannot be cut with a knife, use a soundness test.
8. **Allow coating to cure and then visually examine it for wrinkling, blistering, cracking, bubbling, or other chemical reaction with the underlying paint for liquid coating encapsulants.** For all encapsulants, carry out the appropriate adhesion tests.
9. **Record the results of all patch tests on Form 13.1.**
10. **Develop job specifications.**
11. **Implement a proper Worksite Preparation Level** (see Chapter 8).
12. **Repair all building components and substrates as needed, e.g., caulk cracks and repair sources of water leaks.**

13. **Prepare surfaces.** Remove all dirt, grease, chalking paint, mildew and other surface contaminants, remnants of cleaning solutions, and loose paint. All surfaces should be deglossed, as needed.
14. **Ventilate the containment area whenever volatile solvents or chemicals are used.**
15. **Monitor temperature and humidity during encapsulant application or installation.** For liquid coatings, monitor coating thickness to ensure that the encapsulant manufacturer's specifications are met.
16. **Conduct cleanup and clearance.**
17. **Have the owner monitor the condition of the encapsulant after the first 6 months and at least annually thereafter.** Repairs should be made as necessary. Reevaluations should be completed according to the schedule in Chapter 6.
18. **Provide information to residents on how to care for the encapsulation system properly and how to contact the owner to get repairs completed safely and quickly.**
19. **Maintain accurate records.** Make sure the exact detailed locations of encapsulant applications, concentration of lead in the paint underneath the encapsulant, patch test specifications and results, reevaluations, product name, contractor, and date of application or installation, along with a copy of the product label and a material safety data sheet (MSDS) for the product are included in your records. Record failures and corrective measures, signs of wear and tear, and your certified risk assessor.

I. Introduction

This chapter provides information on: (1) assessment of the suitability of a surface (i.e., the existing paint film) and the building component substrate for encapsulation; (2) types of encapsulant systems; (3) considerations for selection and use of encapsulants; (4) field patch testing; (5) general surface preparation and application procedures; and (6) procedures for ongoing monitoring by the owner and reevaluation by a risk assessor.

A. Definition

Encapsulation is a process that makes lead-based paint inaccessible by providing a barrier between the lead-based paint and the environment. This barrier is formed using a liquid-applied coating (with or without reinforcement materials) or an adhesively bonded covering material. While encapsulant systems may also be attached to a surface using mechanical fasteners, the primary means of attachment for an encapsulant is bonding of the product to the surface (either by itself or through the use of an adhesive).

Encapsulants should not be confused with enclosures, which are rigid barriers fastened by mechanical means to the base substrate (or the structural members). Enclosures rely on mechanical fasteners as the primary method of attachment. Enclosures are addressed in Chapter 12, Section III.

Encapsulation depends upon a successful bond between the surface of the existing paint film and the encapsulant for performance. However, this condition alone is not sufficient for encapsulation system success. All layers of the existing paint film must adhere well to each other, as well as to the base substrate. If not, the encapsulation system may fail. Thus, proper assessment of the suitability of the surface and substrate for encapsulation is essential prior to the application and installation of the product.

The success of an encapsulation application also depends on successful patch testing in the field, proper completion of surface preparation and application procedures, ongoing monitoring by the owner and resident, and periodic reevaluation by a risk assessor. These procedures are discussed in detail in subsequent sections of this chapter.

B. Standards and Acceptance

The American Society for Testing and Materials (ASTM International) has issued three standards for liquid coating encapsulants (www.astm.org/Standard/index.shtml):

- ◆ **E 1975-04** – Standard Specification for Non-Reinforced Liquid Coating Encapsulation Products for Leaded Paint in Buildings.
- ◆ **E 1796-03(2011)** – Standard Guide for Selection and Use of Liquid Coating Encapsulation Products for Leaded Paint in Buildings.
- ◆ **E 1797-04** – Standard Specification for Reinforced Liquid Coating Encapsulation Products for Leaded Paint in Buildings.

Some State and local governments have such standards in place; if they are more stringent, they should be followed.

Encapsulation is considered an acceptable method of federally supported lead-based paint abatement or federally supported lead-based paint hazard abatement, provided the following conditions, procedures, and precautions exist or are followed:

- ◆ The encapsulation product or system is warranted by the manufacturer to perform for at least 20 years as a durable barrier between the lead-based paint and the environment in locations or conditions similar to those of the planned application.
- ◆ Selection and use of encapsulation products or systems follow the manufacturer's recommendations and the procedures and precautions described in this chapter of the *Guidelines* and in other relevant chapters, including those on occupant protection, worker protection, cleanup, clearance, and waste disposal.
- ◆ Patch testing is completed successfully.
- ◆ The property owner or local government agency conducts surface-by-surface visual monitoring of all encapsulant applications 1 month and 6 months from the date of completion of the application and at other times as specified for encapsulation in Chapter 6 of these *Guidelines* and records those results.
- ◆ Failures are repaired as soon as possible, and repairs are made according to manufacturer's recommendations and the procedures and precautions recommended in this chapter and other relevant chapters of these *Guidelines*, including those pertaining to resident protection, worker protection, cleanup, clearance, and waste disposal.

C. Background

Encapsulation technologies can offer safe and effective control of lead-based paint hazards. Encapsulation can be less expensive than other options and may be one of the only alternatives that can be used in certain situations. Encapsulants may also be used in combination with other methods. Unless there is significant surface deterioration, encapsulants may generate low amounts of leaded dust. However, if the encapsulation system fails, repairing the damage, as well as covering the exposed lead-based paint surfaces, may result in high maintenance costs. The advantages and disadvantages of using encapsulants are listed in Table 13.1.

In recent years, encapsulation has been used less often than other abatement methods. The disadvantages of encapsulation as an abatement method appear to have outweighed the advantages in many cases. In historic properties, however, encapsulation may or may not be appropriate (see Chapter 18). Although several States and local governments created lists of approved encapsulants in the past, they may remain in effect. In all cases, the determination should be made what rules and regulations apply before selecting an abatement method for a specific project. When the purpose of the encapsulation of known or presumed lead-based painted surfaces is permanent (that is, 20 years or more) elimination of lead-based paint hazards, that project is abatement and EPA's (or an EPA-authorized state or Tribe's) abatement rules, rather than EPA's (or an EPA-authorized state or Tribe's) Renovation, Repair and Painting (RRP) Rule, apply to that project. However, if application of an encapsulant is not intended as lead hazard abatement, that project is considered a renovation covered by the RRP Rule. This chapter primarily covers encapsulation when used as an abatement method.

A number of products currently being marketed specifically for lead-based paint abatement have been used as specialty coatings and coverings for many years. Some sites with interior and exterior coatings have been found to remain intact for up to 3 years. On the other hand, the same systems have been observed to fail immediately after application or within a period of months due

to inadequate surface preparation or improper selection. Some failures have been widespread, in which the coating system separates completely from the substrate. Some have been more limited, in which cracks appear in the coating or the product is abraded (rubbed away) through normal wear and tear. The limited failures have been attributed to use of encapsulants on surfaces that were not suitable for encapsulation, inadequate surface preparation, or improper selection of product type.

The standards for minimum performance by ASTM involve laboratory testing of products applied to bare substrates under controlled settings. Specific use situations may warrant more stringent performance requirements for certain properties. The encapsulant user will need to determine whether more rigorous performance is needed. Product selection and use considerations are addressed later in this chapter.

II. Assessment of Surfaces and Components for Suitability

Some surfaces and components are not suitable candidates for encapsulation. In these situations, a decision not to encapsulate can be made without further consideration or testing (see Table 13.1). For all other surfaces and components, more extensive field testing is recommended for encapsulation. Once the determination is made that encapsulation is suitable, patch testing of candidate encapsulant systems (including use of the manufacturer’s recommended materials, surface preparation procedures, and application procedures) is essential.

Table 13.1 Advantages and Disadvantages of Using Encapsulants.

Advantages	Disadvantages
<ul style="list-style-type: none"> ◆ Residents may not need to be relocated. Minimal generation of leaded dust if surface preparation is minimal. ◆ Moderate application training requirements. Less costly and more timesaving than some other control techniques if surface preparation is minimal. Wide range of product types available to meet special needs. Finish carpentry work may not be required. 	<ul style="list-style-type: none"> ◆ Experience and information on long-term durability is limited. Use on friction surfaces is inappropriate. ◆ Durability depends on condition of previous paint layers. Field compatibility testing of encapsulant with particular lead-based painted surface is essential (patch testing). Encapsulant system success depends on proper surface preparation. Periodic monitoring and maintenance by the owner is required, since lead has not been removed. ◆ Susceptible to water damage; system failure can be extensive. ◆ Application may be weather- and temperature-dependent and may require several coats. ◆ Some systems may contain toxic ingredients.

A. Specific Surfaces and Components Not Suitable for Encapsulation

Friction surfaces. These surfaces include window jambs and exterior wood flooring or stairs covered with lead-based paint. Some interior floor and stair surfaces may be suitable for encapsulating with a rigid floor covering (e.g., vinyl tile) that is adhesively bonded to the surface (see Figure 13.1).

Deteriorated components or paint films. Components must be sound and essentially free of deterioration to be suitable for encapsulation. Deteriorated components include rotten wood, rusted steel, spalled plaster, and masonry in need of repointing. Use of encapsulants on steel structures is especially difficult, since most do not have corrosion inhibitors and will fail if the steel underneath rusts. Also, components affected by water leaks, poor moisture venting, or other moisture-associated problems should not be encapsulated unless the moisture problem is corrected first. Additional information on inspection of components for damage associated with water penetration can be found in Chapter 11.

Severely deteriorated paint films. Lead-based paint films that are severely deteriorated (e.g., cracked and peeling over most of the surface) are not suitable for encapsulation (see Figure 13.2).



FIGURE 13.1 Encapsulating a floor with vinyl tiles



FIGURE 13.2 Deteriorated paint on surfaces that are unsuitable for encapsulation

Surfaces in which there is a known incompatibility between two existing coating layers.

Usually this determination cannot be made without field-testing. However, if available, historic records may reveal conditions known to cause poor interlayer adhesion. For example, use of a flat latex paint over an improperly prepared, glossy oil-based enamel will likely result in an existing paint system that is not suitable for encapsulation.

B. All Other Surfaces

Surfaces of nondeteriorated substrates having reasonably stable lead-based paint films can be considered for encapsulation. However, a decision to encapsulate should be made only after a field evaluation of the condition of these films is conducted, using patch tests. A patch test is a field test procedure in which a small area of the existing lead-based paint film is prepared and the encapsulant product is applied or installed and cured in the manner intended for the large-scale job. A field evaluation should determine the extent of deterioration, the condition of the surface, and the integrity of the underlying paint layers. These factors should be considered because an encapsulant cannot attach itself to a deteriorated paint base. Some paint films cannot support the additional weight or stress of an encapsulant, because of existing film thickness, poor adhesion between paint layers, or low cohesive strength within a layer. Existing film thickness can be measured using a dry film thickness gauge, such as a Tooke gauge or a micrometer. Information on the thickness of existing coatings can be provided to an encapsulant manufacturer's or distributor's technical representative to help in making appropriate recommendations.

The visual extent of deterioration, surface deterioration, and interfacial or cohesive film weaknesses should be evaluated, before use of encapsulants, in the following ways:

Visual Evaluation. Visual deterioration includes peeling, flaking, blistering, and cracking of paint films. The level can be rated based on ASTM photographic standards, such as ASTM D 610 for rusting, D 770 for blistering, etc (www.astm.org/Standard/index.shtml). An entire surface can usually be inspected for these defects. Often, both the extent of the surface that is deteriorated and level of deterioration are assessed. For example, 5 percent of the surface may be deteriorated to a rating level of one (i.e., severe) or the entire surface may have slight deterioration (Refer to Chapter 5 Section I.D.3). Quantitative rating in this fashion may be required by the encapsulant manufacturer, but not by HUD at this time.

Surface Deterioration. Surface deterioration includes chalking, mildewing, and soiling. Standard ASTM procedures can be used to rate the degree of these conditions. Enough determinations need to be made to properly characterize the surface. However, since this type of deterioration tends to be widespread and is usually rather uniform over large surface areas, determination of two or three locations may adequately describe the condition.

Interfacial and Other Film Integrity Properties. Since most lead-based paint films are made up of many paint layers, a measure of how well the layers are adhering to each other and the base substrate is needed prior to the use of an encapsulant. Also related to interfilm adhesion is cohesive strength within films. These properties are usually assessed using a field adhesion test, such as a crosshatch or "X-cut" test with tape, a pull-off adhesion test, or a probe of the film with a knife. Interfacial deterioration may not be uniform over a large surface area (since it may be defect-related) and will vary from location to location across a surface. Thus, it is important to conduct enough interfacial integrity tests to obtain a representative sampling of the entire area.

Surfaces with intact paint and that sticks to the substrate are good candidates for non-reinforced encapsulants. Surfaces with peeling, flaking, or cracking paint films are usually not good candidates for non-reinforced encapsulants unless the loose coating can be removed. However, reinforced encapsulants may be suitable if the areas of deterioration are localized and reasonably small. In these cases, the reinforced coating can hold across the deteriorated areas. Encapsulants that have adhesive in them may be suitable for either surface type.

III. Encapsulant Classification

Within each of the three general classifications, there is a range of material types and properties (see Table 13.2). Manufacturer's data must be consulted to obtain specific information.

Residential paints, such as latex and alkyd-based paints and canvas-backed vinyl wallpaper, do not constitute encapsulant systems unless they pass the patch test (evaluating the encapsulant on a small area of the painted surface before the start of work) and meet the performance requirements of this chapter and any quantitative performance standards defined by ASTM or other local, State, or Federal agency. (See Section VI.A)

Table 13.2 Categories of Encapsulants.

Encapsulant Category	Application and Installation Method	Characteristics
Non-reinforced liquid coatings.	Usually applied with brush, roller, or spray.	Interior and exterior products. Some properties vary widely, such as elongation (e.g., elastomeric with high elongation to rigid with limited elongation), dry film thickness (0.05 mm to greater than 0.5 mm), hardness, dry/cure time, and compatibility with existing painted surfaces.
Liquid coatings reinforced with cloth, mat, fibers, etc.	Applied with brush, roller, spray, or trowel. Usually applied in two steps.	Interior and exterior products. Properties vary widely.
Materials adhered with an adhesive (e.g., fiber mat, vinyl floor tile).	System is usually installed in two steps: (1) adhesive application and (2) encapsulant product installation.	Classification includes sheet vinyl systems, floor tile, wall systems, and other adhesively bonded systems.

IV. Minimum Performance Requirements for Encapsulants

Four general performance requirements for encapsulants are as follows:

- ◆ The encapsulant must be capable of being applied safely and must not contain toxic substances.
- ◆ The encapsulant must adhere to existing paint films.

- ◆ The encapsulant must have the ability to remain intact for an extended period of time when exposed to the expected environmental conditions and use patterns.
- ◆ The encapsulant and its application procedure must comply with fire, health, and environmental regulations.

A. Safe Application

All encapsulants must be able to be applied safely, without excessive worker or occupant exposure to hazardous solvents, curing agents, or other chemicals in the encapsulant, either by inhalation or by contact with the skin.

B. Adhesion

An encapsulant must adhere to the existing paint film. Adhesion can be measured using peel, tensile, or shear tests. However, adhesion of an encapsulant to the lead-based paint film is not sufficient for success of the encapsulant system; the integrity of the underlying paint layers is also crucial. Each of these layers must adhere well to other layers, and the base substrate. In addition, each layer must have sufficient cohesive strength to support the increased internal stresses caused by the addition of an encapsulant layer.

C. Ability To Remain Intact

The ability of a film to remain intact depends on many factors, some of which are specific to the conditions in which the encapsulant is used. For example, an encapsulant may suffer impact and abrasion damage. It may also be exposed to water and other household chemicals, changing temperatures, changing substrate dimensions, and other degrading environmental conditions. Laboratory procedures used to investigate these properties are loosely grouped into tests for mechanical, chemical resistance, and durability properties.

1. Mechanical Properties

Mechanical properties include tensile properties (elongation, tensile strength, modulus), flexibility, abrasion resistance, and impact resistance. Most of these properties are interrelated and may depend on temperature.

Mechanical properties of coatings should be considered in selecting an appropriate material. For example, more flexible materials may be more likely to resist cracking when the substrate moves because of vibration, changes in temperature, changes in moisture content, or settling. If this mode of performance is important, the encapsulant must remain flexible over the complete range of exposure temperatures. Some elastomeric encapsulants have failed by cracking because they became brittle at low temperatures. Reinforced encapsulants may be more likely to resist cracking over existing substrate cracks or new substrate cracks than non-reinforced encapsulants. This is because stresses produced in a reinforced encapsulant as a result of substrate cracking or other movement are distributed over a larger area than for non-reinforced materials.

Abrasion resistance refers to the ability to resist wearing, such as from rubbing against a surface or from cleaning with abrasives. Examples of surfaces where abrasion is likely to occur

include railings, walls, moldings around door and window openings, and interior window sills where air conditioner units are installed and removed.

Impact resistance is the ability of a coating to resist cracking or loss of adhesion upon direct impact by an object, such as a toy or tool. Good impact resistance is needed for surfaces adjacent to door openings and for walls in recreation rooms and entryways.

2. Chemical Resistance Properties

Chemical and water resistance is essential for long-term stability of an encapsulant. Interior encapsulants may be exposed for extended periods of time to both water (steam, vapor, and liquid) and, in limited situations, chemicals. For example, on horizontal surfaces, water or chemicals (e.g., cola, cleaning solutions) may stand until evaporated. An encapsulant must be able to withstand such exposures without blistering, peeling, cracking, or losing film integrity.

3. Durability

For all encapsulants, it is essential that the mechanical and chemical properties of the material remain essentially constant over time. For exterior exposures, this means that an encapsulant must also be resistant to degradation by sunlight, moisture, and temperature variations. Until specific criteria are available, manufacturers should be asked to supply information and warranties on the durability of their products.

D. Fire, Health, and Environmental Requirements

Encapsulants must meet all local fire code requirements. Since their film thicknesses are often much greater than that of paints, there may be additional fire-related requirements. Building codes and material safety data sheets (MSDS) must be consulted to ensure safe application and to provide information on when residents can safely reenter the area. The MSDS will also provide information on toxic substance content. In addition, environmental volatile organic compounds (VOC) regulations limit the VOC content of paints in the U.S., with additional regulation in many localities.

V. Factors to Consider in Selecting and Using Encapsulant Systems

When encapsulation is suitable and is the desired control strategy, a user has a wide range of systems from which to select. In addition to the requirements of Section IV, the decision to select a specific type or system should take into account several other factors, including those related to the type of lead-based paint film and base substrate, service conditions, cost, livability, and health and safety issues.

A. Base Substrate

The base substrate can be wood, plaster, steel, cement, masonry, stucco, or some other material. Thus, the movement and possible deterioration of the substrate vary and should be considered. For example, wood will expand and contract with changing water content and perhaps check and crack as it ages. Wood rot could also occur if water leaks or other moisture problems are ignored. Stucco may develop cracks as it ages or the building settles. An encapsulant must be able to move with the base substrate without cracking or otherwise deteriorating.



FIGURE 13.3 Encapsulated historic components.

Walls with extensive cracks and gaps that cannot be bridged by non-reinforced coatings may be good candidates for reinforced coatings or wall coverings. For situations in which non-reinforced coatings can be used, cracks must be filled with a caulking or sealing compound compatible with the encapsulant and the substrate to which it is applied.

Control corrosion of metal substrates with a proper primer before applying an encapsulant. Uncontrolled rusting will quickly lead to delamination of an encapsulant. Thus, a corrosion-control primer is an essential part of an encapsulant system for metal.

B. Lead-Based Paint Film Properties

An encapsulant must be compatible with the existing lead-based paint film. Both chemical and physical properties of the film are important. A compatible encapsulant must form a strong bond with the lead-based paint film but not degrade the existing paint layers. Epoxies, polyurethanes, and other coatings having strong solvents are often incompatible with oil/alkyds and latex paint films.

Physical properties of old films also affect performance of coatings and adhesives applied over them. Water-based products tend to bond less successfully to glossy, smooth, chalky, dirty, or oily paint film surfaces than do compatible solvent-based materials.

Field patch testing is the best procedure for determining compatibility with the existing lead-based paint surface and early performance properties of the encapsulant.

C. Application and Installation Constraints

Application constraints include the skill required for application, the method of application and acceptable range of environmental conditions, and regulations for worker safety and environmental protection.

1. Skill Level

Different levels of skill are required for application of the various classes of encapsulants. Generally, liquid non-reinforced coatings require the lowest skill level. Coatings having two components (requiring rapid, efficient application), or those incorporating a mat, require more experience and skill. Use of adhesively bonded materials, such as tile and flexible wall coverings, also require an intermediate skill level for application (HUD, 1990b). Overall, skills required for encapsulation are lower than those for enclosure and replacement. Nevertheless, specific knowledge and skills are critical for success in the application of any encapsulant.

2. Method and Environmental Conditions

Depending on the specific encapsulant, application of the coating or adhesive may be by brush, roller, spray, or trowel; however, in certain situations, some of these methods may not be feasible. For example, if spraying is not practical, an encapsulant that can be applied by

another technique will be required. The acceptable environmental conditions vary depending on the type of encapsulant. For instance, temperatures above 40° F and below 95° F and relative humidity less than 85 percent are generally required for water-based coatings. Moisture-cure polyurethanes may require a minimum relative humidity. A manufacturer's technical specifications should be consulted for specific requirements.

3. Regulations

Worker safety requirements vary depending upon the material being applied. The manufacturer's MSDS should be consulted for appropriate controls. The EPA published a national VOC emissions rule for all architectural coatings (63 Federal Register 48848; September 11, 1998), which became effective in 2000 (the final, amended, rule was published at 65 Federal Register 7736; February 16, 2000; www.epa.gov/ttn/atw/183e/aim/fr16fe00.pdf). Consequently both local and national rules may place VOC limits on the use of encapsulants.

D. Environmental Service Conditions

The conditions under which the encapsulant will be used are important when selecting an encapsulant. For exterior exposures, consideration must be given to an encapsulant's ability to withstand varying weather conditions, including temperature changes, temperature extremes, water, moisture vapor, air pollutants, and ultraviolet radiation. For example, some elastomeric products can become brittle when exposed to cold temperatures and may shatter on impact. Other materials, such as epoxies, prematurely chalk and erode because of ultraviolet deterioration.

Since some exterior – and even some interior – environments may be quite wet, encapsulants must not fail due to moisture. The water vapor permeability should be considered, along with the permeability of the component to be encapsulated. An encapsulant with low water vapor permeability may peel because of a moisture gradient across the component. For example, in climates with cold winters, an impermeable encapsulant applied to exterior walls lacking an internal vapor barrier may blister and fail because of interior moisture passing through the building envelope.

E. Use Conditions

The use of encapsulation on impact and friction surfaces is generally not recommended because the covering does not protect lead-based paint from impact and abrasion. HUD's Lead Safe Housing Rule does not include coating (or painting over the surface) as an allowable interim control to treat painted impact and friction surfaces (see 24 CFR 35.1330(c)(6)). If a lead-based paint surface is subject to frequent abuse (e.g., abrasion, impact, and rubbing), especially careful consideration must be given before using encapsulation as an abatement method. If encapsulation is selected, thoughtful consideration must also be given to the selection of an encapsulant product for the particular conditions of wear and tear the component will receive. Also, the tolerance for increased coating thickness varies depending upon the component type. For example, reinforced coatings or fiber-reinforced wall coverings having high abrasion resistance are potential candidates for walls subject to extensive abrasion and impact wear, such as in entrance hallways. Coatings having excellent chemical resistance (e.g., some epoxies) can be good candidates for surfaces containing large amounts of hand oil, such as handrails and surfaces around doorknobs. When use factors are not considered, premature failures are likely. For example, elastomerics, which typically have poorer chemical resistances than two-component coatings, have been reported to fail prematurely when used on handrails (Maryland, 2002).

F. Encapsulant Service Life

Epoxy paints, cementitious encapsulants, floor tile, and flexible adhesively bonded wall coverings have been used for other purposes and tend to have relatively long life spans. Some coatings have qualities that may make them more durable than ordinary residential paints, e.g., a polyurethane binder is usually more abrasion-resistant than an oil binder. Since some encapsulants have been in use for a few years, field data may be available for some products. Also, the manufacturer's warranty or guarantee is an important consideration in product selection. When the product is used for lead-based paint encapsulation, conditions of the warranty may require prework inspections, surface preparation inspections, in-process inspections, and a final inspection.

G. Safety Constraints and Information

Each encapsulation product has an MSDS available from the manufacturer, which should be obtained, reviewed, and filed as part of the recordkeeping procedure. The MSDS provides information on hazardous ingredients (specific chemical identities and common names); physical and chemical characteristics (boiling point, water solubility, melting point, evaporation rate, specific gravity, vapor pressure); fire and explosion hazard data (flashpoint, extinguishing media and firefighting procedures, and any unusual fire/explosion hazards); reactivity (stability and incompatibility, hazardous decomposition, or products); health hazard data (routes of entry, acute and chronic health hazards, carcinogenicity, signs and symptoms of exposure, medical conditions generally aggravated by exposure, and emergency and first-aid procedures); precautions for safe handling (waste disposal, handling, and storing); and use and control measures (respiratory protection, eye protection, protective gloves, ventilation, and other protective measures and hygiene practices).

Some MSDSs do not disclose the presence of toxic substances under trade secret provisions. If an MSDS does not show chemical ingredients and claims no hazardous ingredients are present, but still indicates eye and skin protection or ventilation is necessary, the MSDS may be deficient. If employees believe an MSDS is deficient, they should notify the individual responsible for MSDS sheets or the Hazard Communications program in their organization. Occupational Safety and Health Administration regulations require employers to maintain current MSDSs for all products containing hazardous chemicals that are used by employees.

It may be useful to have a toxicologist or industrial hygienist review the MSDS and/or consult any of the available toxicology database systems, such as the Hazardous Substance Database, the Integrated Risk Information System (IRIS) (EPA), and Registry of Toxic Effects of Chemical Substances (RTECS) from the National Institute for Occupational Safety and Health (NIOSH). Both worker and resident safety should be taken into consideration. For example, residents and pets may be exposed to VOCs during the drying or curing process.

H. Aesthetics

To maintain an acceptable appearance, the finished product should be capable of being painted, or otherwise coated, and maintained. Consideration should also be given to the importance of having a finished surface that is smooth or rough (textured) or soft or hard. For example, encapsulants that are either soft or have a rough finish are not appropriate for handrails and floors and may make cleaning of wall surfaces more difficult. Also, soft coatings have a greater tendency to adhere to or be imprinted by objects placed on them than do harder coatings. The final thickness of the encapsulant also affects the appearance of the product. For example, the final thickness of many

elastomeric encapsulants (10 to 20 mil) is about 10 times greater than a single layer of paint and can conceal desired detail on wood trim and moldings.

If the existing coating is not intact or smooth and requires substantial sanding and feathering, then a non-reinforced liquid encapsulant may not be the appropriate product type. Non-reinforced liquid encapsulants are less likely to hide surface imperfections than reinforced liquid coatings or adhesively bonded wall coverings.

I. Repairability

Repairability refers to the ease of repairs and the appearance of the affected areas. It is important to determine if repairs can be performed only by outside contractors with special equipment or skills or if typical maintenance workers can do them. Generally, all encapsulants are repairable, although some types may be more difficult to repair than others.

J. Cost

Depending upon the type of substrate to be treated, the life cycle costs of encapsulation methods may be less than for enclosure methods (HUD, 1991). Life cycle costs include both the initial costs and reexamination and maintenance costs. Initial per-unit costs (material plus labor) associated with the various encapsulant products vary. Since labor may be a major part of the cost, encapsulant systems requiring more than one layer or step may be more expensive than those completed in one operation. In addition, the total time required for application and cure is a cost-related factor if occupants need to be housed away from the worksite during this time. The length of time needed for the encapsulant to remain effective should also be included in life cycle cost considerations.

K. Technical Assistance

For large projects, a technical representative from the product supplier or manufacturer should be involved in the choice and inspection of the surface preparation procedure and the application processes. It is important to clarify the nature and extent of any support that is being offered. If no technical support is offered, consideration might be given to other products where support is available. The manufacturer's involvement in quality assurance activities is desirable, and every effort should be made to cooperate with those involved.

VI. Specific Encapsulant Products and Surface Preparation Procedure

A. Encapsulant Product Selection

Once a surface has been found suitable for encapsulation and a decision has been made to encapsulate, a specific product or product type is selected, together with appropriate surface preparation and application procedures. The procedure for selecting a specific encapsulant product is to: (1) obtain information from the manufacturer's literature, users' experiences, and any other credible knowledge base on the products' ability to meet the general performance requirements and the factors listed previously in this chapter; (2) select a group of candidate encapsulant products and surface preparations using this information; and (3) conduct field patch tests with the candidate products on the surfaces to be encapsulated.

B. Surface Preparation

After an encapsulant product or type has been selected, surface preparation procedures need to be identified. All encapsulant manufacturers provide surface preparation recommendations for their products. In some instances, manufacturers provide more than one specific recommendation. Thus, it is essential to select one or more suitable specific procedures prior to application of the encapsulant. Consideration should be given to identifying and testing more than one specific surface preparation procedure because the same encapsulant may be successfully used with one procedure and not another. Cost and time savings may be significant for some encapsulants if more than one surface preparation is tested at the same time. The cure time, and thus the test time, may be long.

General surface preparation requirements, which are similar for all encapsulants, are presented below. Materials used and debris generated during surface preparation may be hazardous and must be treated appropriately.

1. Cleaning

Encapsulants should not be applied over dirt, rust, oil, grease, mildew, chalk, or other surface contaminants. Surfaces should be cleaned with nonsudsy degreasers, or other materials recommended by the manufacturer. Additional cleaning agents may be needed for mildew or chalk removal. Cleaning can be done by hand with a sponge or rag or with the aid of power washing equipment. In either case, it is essential to rinse the surface thoroughly with water to remove cleaning residue. Job specifications may require that specific standards be met for removal of surface contaminants, e.g., ASTM D 4214 for chalk. In situations where chalk cannot be removed to an acceptable level, the use of a primer or stabilizer may be needed. If a special primer is used, it is essential that it is one recommended by the encapsulant manufacturer.

2. Deglossing

The surface of some lead-based paint films is smooth and glossy. Deglossing to roughen the surface is usually recommended by manufacturers to improve adhesion of the encapsulant coating. Often, specific deglossing materials will be recommended, since they must be compatible with the encapsulant. For some very hard, chemically resistant surfaces, deglossers may not work, and wet sanding may be needed. Since the choice of deglossing materials or methods affects encapsulant adhesion, separate patch tests using different deglossers or methods should be considered.

3. Removal of Loose Paint

Loose paint should be removed by wet scraping.

4. Preparing Exposed Base Substrates

These substrates can warrant different surface preparation requirements than lead-based paint surfaces. For example, the surface of bare wood exposed to sunlight should be wet sanded to remove the degraded surface layer. Corroded metal should be cleaned using HEPA-assisted power tools or HEPA vacuum blasting to remove surface rust and contaminants. Bare concrete and masonry materials should be washed to remove loose dirt, degraded materials, or other surface contaminants.

C. Field Patch Tests

A patch test evaluates the encapsulant on a small area of the painted surface prior to the start of work. When more than one surface preparation is being tested, each surface preparation procedure, plus the encapsulant, is a separate patch test. An encapsulant/surface preparation system that fails a patch test is not suitable for use in the large-scale job.

Certified contractors or knowledgeable workers can do surface preparation and encapsulation applications and installations. After the encapsulant has cured according to the manufacturer's recommendations, an inspector performs the evaluation. It is important to contact local or State agencies before starting work in case they have inspection protocols in place for this kind of work.

1. Size of Patch Tests

For liquid-applied systems, the recommended test patch size is about 6 by 6 inches. For narrow surfaces such as doorframes, a differently shaped patch may be needed but should be about the same area. Smaller 3- by 3-inch patches may be used for fiber-reinforced wall coverings, since they may be impossible to remove and can be thick enough to show through a completed system.

2. Location of Patches

At least one test patch should be applied to each type of component in each room or exterior location representing different types of paint where the encapsulant is to be used. For example, if the encapsulant is to be used on walls in both the kitchen and the living room, a patch test should be done on one wall in each room. Although the rooms may appear to have the same surface paint, past painting practices may have been different; therefore, both rooms should be tested. The paint testing protocol contained in Chapter 7 also is based on the idea that paint history and type is unique for each room. If localized areas of a surface or component are suspected of having underlying adhesion problems due to moisture, then the patch test should be done in one of these areas. Outer walls are good areas to test since they may be more likely to experience moisture. Similarly, load-bearing walls are good areas for patch testing because they are subject to stress. For thick, reinforced coatings or wall covering systems, patches should be placed in an inconspicuous place, if possible. If it is known that one type of component has the same paint history in several rooms, only one patch test is needed for that component type.

3. Surface Preparation for Patch Testing

The area prepared for the patch test should be at least 2 inches larger in each direction than the area to be encapsulated for the test, unless the shape of the component makes this impossible. The surfaces should be inspected following preparation to ensure that the preparation was carried out properly. The inspection results should be documented separately for each patch.

4. Encapsulant Application and Installation

The encapsulant(s) should be applied in accordance with the manufacturer's recommendations. The application method, wet film thickness (if appropriate), and environmental conditions should be documented for each patch, since they should be the same when used on the

target surface. For encapsulants that cannot be cut with a knife, consideration should be given to substituting the soundness test described below. After the encapsulant has cured, the patch is examined for adhesion and compatibility with the existing lead-based paint film. Since the cure times of encapsulants range from less than 24 hours to a period of months for a complete cure, it may not always be possible to perform patch tests on completely cured patches. Nevertheless, the patch test is still a useful method of assessing the likelihood of success with a given product on a given surface.

5. Patch Preparation for Conducting a Lead-Based Paint Soundness Test

The following procedure has been employed in past projects to prepare a patch test for soundness or integrity of the lead-based paint film/base substrate system. A 3/8- by 3-inch bead of construction adhesive is applied to the central portion of the face of an 8-inch-square piece of gypsum wallboard. The wallboard square is pressed onto a 6- by 6-inch patch. The curing time recommended by the adhesive manufacturer should be observed. Evaluation of results is discussed below.

6. Visual and Adhesive Evaluation of Field Patch Tests

The encapsulant coating should be visually examined for signs of incompatibility with the paint film. These signs include wrinkling, blistering, cracking, cratering, and bubbling of the encapsulant. Solvent-based encapsulants (e.g., epoxies, polyurethanes) may react with the underlying paint layer and cause bubbling, disbonding, or other lead-based paint film deterioration. Bubbling or disbonding may be detected by scraping the surface of the patch, using sufficient pressure to break any visible and nonvisible surface bubbles. Surface imperfections may indicate that the encapsulant is incompatible with the existing coating. Bubbles may also form in liquid encapsulants because of foaming during application, solvent entrapment during cure, and other conditions. If it can be established that the bubbles are associated with chemical reactions between the encapsulant and the underlying paint film, or the extent of bubbling is unacceptable, the patch test is a failure. If deeper probing reveals a weakened layer of paint, the patch test is also a failure. If it has failed a patch test, the encapsulant should not be applied to the target surface.

While the ASTM has two standard field methods for measuring adhesion of coatings – a tape test using pressure-sensitive tape (ASTM D 3359) and a portable adhesion tester (ASTM D 4541), they have not been technically defined or used for field patch testing of lead-based paint encapsulants.

“X”-Cut Adhesion Method. For the “X”-cut method, the inspector should take a sharp cutting tool (e.g., a knife, razor blade, or scalpel) in good condition and a hard metal ruler (as a cutting guide) and inscribe an “X” in the center of the patch after the encapsulant system has cured according to the manufacturer’s recommendations. Each cut line should be 1 1/2 to 2 inches long and should be made through the coating, the paint, and the patch all the way down to the substrate. A flashlight may be necessary to determine the depth of the cut. If the cut does not go through the patch to the base substrate, a second “X” cut should be made in a different location. The first cut should not be deepened.

To evaluate the adhesion and integrity of the paint film, the inspector should use the point of the cutting tool to attempt to peel or lift the patch from the existing topcoat. The point of the tool should be placed below the encapsulant layer at the intersection of the two cut lines. If the inspector can lift, peel, or tear a large (more than 1/2 inch- or 1/2 inch-square) portion or section

of the patch away from the existing topcoat to which it was applied, then the encapsulant fails the patch test. The inspector should expect that a small piece of the patch would separate from the base substrate (up to 1/4 to 1/2 inch). This does not indicate failure of the patch test.

Patch-Edge Method. For the patch-edge method, the inspector should make a cut adjacent to the edge of the patch through to the base substrate. If the thickness of the encapsulant does not change abruptly, but gradually decreases at the edge of the patch, the cut should be made through as thick a layer of the encapsulant as possible to the base substrate. The point of the knife should be placed under the encapsulant at the cut, attempting to peel or lift the patch from the lead-based paint topcoat or locate other delaminated layers within the lead-based paint film. If a large portion of the encapsulant can be lifted easily, then the patch test fails.

Soundness Method. For the soundness method, the inspector should attempt to pull the wallboard square away from the painted surface. If the paper backing of the wallboard remains on the adhesive of the painted surface of the patch, the test is a success. The patch test fails if the adhesive is removed from the surface of lead-based paint or if the paint film splits. Failure at the adhesive/wallboard interface can perhaps be overcome by the use of a different surface preparation procedure, as discussed below for the encapsulant patch test.

If failure occurs in any of these procedures, it is important to carefully examine the back of the delaminated portion of the patch in order to determine if the failure occurred at the encapsulant/paint film interface or in an underlying layer of paint. As discussed below, encapsulation may still be suitable – with a different system or surface preparation – when the failure is interfacial but not when the failure is within the old paint film. It may be difficult to determine the locus of failure if the paint layers and the encapsulant coating are similar colors.

If a failure occurs, one of the following courses of action must be taken, depending on the cause of failure:

- ◆ **The adhesion between two underlying layers of paint failed, causing delamination.** Check for this condition by examining the back of the delaminated portion of the patch for signs of paint. This result indicates a layer of paint that bonded poorly and does not have sufficient adhesion. Poor bonding between underlying layers may be due to inadequate deglossing, poor quality paint, or incompatible coatings. These conditions are usually not correctable. Since multiple patch tests are recommended, complete all patch tests before deciding upon a plan of action. The encapsulant should not be used on a surface or component that has failed patch tests.
- ◆ **The adhesion between the paint and the base substrate failed.** Check for this by looking for signs of bare substrate and paint adhering to the back of the delaminated portion of the patch. Failure may be due to a painting history that has included so many layers of paint that the weight of the paint plus the encapsulant has begun to weaken the bond between the paint and the substrate. Moisture can also cause this type of failure. This is usually not correctable, and the encapsulant should not be used.
- ◆ **The adhesion between the encapsulant coating and the top layer failed.** Check for this by examining the back of the delaminated portion of the patch for lack of paint. Failure may be due to:

- Application of the encapsulant to a glossy surface without adequate deglossing. It may be possible to degloss the surface using a different technique and apply a second patch test to a different area on the same component. Wet sanding is permitted to degloss but not dry sanding.
- Inadequate curing time or improper curing conditions. Manufacturers' recommendations for curing and application conditions should be consulted.
- Application of the encapsulant to a dirty or greasy surface. The surface must be recleaned, and possibly deglossed before a second patch test is tried.
- Application of material to excessive thickness. This can cause failure due to internal stresses that cause the coating to pull away from the substrate. The applicator should be trained according to the manufacturer's instructions and a wet film or dry film thickness gauge (sometimes referred to as a "mil" gauge) should be used during application.



FIGURE 13.4 Encapsulant failure.

Evaluation of Adhesively Bonded Flexible Surface Covering Tests. A successful patch is one that cannot be easily removed. If the patch cannot be removed, the covering will have to be installed over the patch. In such a case, a smaller patch in an inconspicuous place will minimize the irregularity in the appearance of the finished product (see Figure 13.4).

7. Documentation of Patch Test Results

Patch testing may involve multiple patches on multiple surfaces. Therefore, documentation is very important to be sure that the correct encapsulant systems (including surface preparation) are applied to the target surfaces. If multiple patch tests are performed in a dwelling, it is recommended that a schematic drawing be used to indicate the locations of the patches. Form 13.1 can be completed for this purpose.

VII. Application and Installation of the Encapsulation Systems

Upon successful completion of a patch test, the encapsulant system can be applied or installed to the targeted surface. The steps for a proper application of an encapsulant system are summarized in Table 13.3.

A. Surface Preparation for Job

The surface preparation must be the same one that was used in the successful patch test and should be conducted with the same thoroughness and level of effort. The process of repairing components and preparing surfaces for the application and installation of encapsulants can generate leaded dust and debris, so precautions must be taken. Take precautions based on the methods used. The appropriate Worksite Preparation Level should be selected from Chapter 8.

Repair of defective surfaces or components may also be necessary. The encapsulant manufacturer should be asked to provide recommendations for caulk and other filling compounds that are compatible with the encapsulant. To minimize future crack formation in the encapsulant, these materials should match the expansion characteristics of the encapsulant and be compatible with the existing coatings.

Table 13.3 Steps for Obtaining Proper Application and Installation of an Encapsulant System.

Step	Description
Test substrate.	Complete patch test and other prejob procedures.
Develop job specification.	Prepare complete job specifications. Describe all work to be done. Include all job requirements (e.g., quality of surface preparation, dry film thickness). Reference standard procedures or equipment to the extent possible to avoid misunderstandings.
Hold pre-job conference.	Establish common understanding of amount and quality of work to be done among owner/specifier, contractor, and inspector. For example, all parties should agree on the extent of surface preparation. Document any changes in writing to avoid future disputes. The contractor should be prepared to provide work (scheduling) plans, worker safety plans, lists of materials and the amounts to be used, material manufacturer's written technical data sheets, application instructions, MSDS, test reports, and other information required in the job specification.
Conduct inspection.	Inspect coating operations. This is essential in obtaining a durable encapsulant system. The inspector should record all inspection data in a daily logbook. Suggested "inspection checkpoints" are described in Section C.2.
Perform final inspection.	Conduct final clearance testing as described in Chapter 15.

For large jobs, it is advisable to have an encapsulant manufacturer's representative onsite to provide additional information on repair and surface preparation. When the repair work and the surface preparation have been completed, the surface should be inspected prior to application and installation of the encapsulant. Once the encapsulant is applied, it becomes impossible to fix a poor surface preparation or, in the case of a failure, to confirm that surface preparation was done properly.

B. Installation and Application of Encapsulant System

1. Non-reinforced and Reinforced Coatings

The application procedures and requirements depend upon the specific product type. The same application method should be used for the targeted surface that was used in the patch test.

Several safety considerations are important in application: the applicator must have the appropriate MSDS documentation; personal protective equipment may be needed and must be in compliance with NIOSH or OSHA regulations; and areas need to be properly ventilated.

Masking procedures should be carried out, as needed. Surfaces to receive masking tape or other masking materials should be clean and free from dirt, dust, grease, and oil to ensure



Form 13.1 Encapsulant Patch Test Documentation.

Name of Person Performing Patch Test _____

License or Certificate Number (If Applicable) _____

Complete Address of Dwelling _____

Date Patch Test Applied _____ Curing Time _____

Date of Patch Test Evaluation _____

Temperature During Application and Curing _____

Humidity During Application and Curing _____

Room	Surface Location	Substrate	Type of Patch Test (X-cut or Adhesive Wallboard)	Surface Preparation	Name and Formulation of Encapsulant	Observations	Pass/Fail

good contact. Loose edges of masking materials should be secured to avoid “flyaway,” if spray application is being used. The time between coating application and masking material removal may depend upon the specific encapsulant being used.

The required environmental conditions for application depend upon the specific encapsulant being used. The manufacturer’s specifications should be followed. As noted previously, water-based systems generally should not be applied to substrates when temperatures are below 40°F or above 95°F and the relative humidity is above 85 percent. For all encapsulants, application should be done only when the surface is dry and the temperature of the target surface is above the dew point.

Additional mixing and/or thinning of liquid encapsulants may be needed and should be done in accordance with the manufacturer’s directions. Excessive thinning can cause premature failure. For two-component coatings, it is essential that the proper ratio of materials be mixed according to the manufacturer’s directions. Not all two-component products are to be mixed together in the same ratio. Two-component materials will have a limited “pot life.” That is, once the two components are mixed, a chemical reaction begins that can be slowed, but not stopped, by cooling. This means that the user has a limited period of time, i.e., pot life, in which to apply the product and to clean tools. Two-component coatings may also have an “induction time” requirement. This is a period required after mixing but before application to allow time for initiation of the reaction between the two components.

Encapsulants should be applied according to the manufacturer’s recommended thicknesses. Wet film thickness gauges (sometimes called mil gauges) should be used to ensure proper film thickness. An encapsulant layer that is either too thick or too thin can cause premature failure.

Reinforced liquid encapsulants can require the use of a fabric. The manufacturer’s recommendations for application of the fabric and procedures for seaming should be followed.

For liquid coatings, cure times vary from product to product and can depend upon atmospheric conditions. Thick elastomeric coatings may take only a few hours to be dry to the touch, but it may take several weeks for their mechanical properties to reach optimum values. The time for two-component coatings to cure depends upon temperature but is generally about a day.

2. Adhesively Bonded Coverings

Adhesively bonded wall coverings are installed in a manner similar to that used for vinyl wall coverings (NBS, 1973). No special tools are required. The typical three-step procedure is to apply adhesive with a roller; align and trowel the covering over the adhesive; and apply the topcoat, if needed. There are two options for coloring. The adhesive can be tinted the same color as the topcoat, which ensures two coatings with color, or two topcoats with color can be applied over untinted adhesive.

Some product manufacturers do not supply specific adhesive and topcoat products but only provide recommendations for choosing these products. Generally, there are two types of adhesives – “permanent” clay-based adhesives and water-based, heavy duty, but strippable adhesives. Since the permanent clay-based adhesive is more durable, it is preferred for lead-based paint encapsulation. However, removal of a wall system is difficult, if not impossible,

when the permanent adhesive is used. Water-based adhesives are more easily removed than permanent adhesives but may blister and fail when they come in contact with moisture.

Adhesively bonded floor tile should be installed according to the manufacturer's directions. If new subflooring is installed, then the tile/subfloor system constitutes an enclosure. If adhesion alone is used, the tiles constitute an encapsulant.

C. Inspection of Encapsulant Systems

Proper application and installation of encapsulant systems requires that the surface preparation and application procedures are carried out according to the manufacturers' recommendations and in accordance with the job specifications, if any. Monitoring of surface preparation and application is essential, in addition to conducting the final clearance examination. (See Table 13.3.)

1. Tools

Tools that may be required are a dark cloth to check for chalk removal, copies of referenced surface preparation standards, wet film and dry film thickness (measured in mils, or 10 micrometers) gauges, a moisture meter, surface and air thermometers, a relative humidity meter, pressure gauges, a timepiece, and an illuminated viewing device. A logbook should be used to record all inspection data.

2. Procedures

Surface preparation and application inspection checkpoints and procedures are listed below:

- ◆ Prior to start of job – check equipment and encapsulant material.
- ◆ After preliminary cleanup and readying of the area prior to surface preparation – check for containment, protection of belongings and property, and completion of surface repairs, such as caulking.
- ◆ After surface preparation – ensure that the surface has been prepared in accordance with the specification and in the same manner as used in the patch test.
- ◆ For liquid encapsulants, just prior to material application – observe mixing and thinning, if any, for compliance with manufacturer's written instructions. Ensure that mixing ratio of two-component coatings is correct.
- ◆ During application of encapsulant – check environmental conditions (temperature, relative humidity, etc.). For liquid coatings, check wet film thickness, color of material (different colors should be required for different coats), and cure of previous coat before application of next coat for compliance with manufacturer's written instructions.
- ◆ After job completion – check dry film thickness and cure of liquid-applied coatings and appearance for all encapsulants.

VIII. Ongoing Monitoring and Reevaluation

Because of the limited experience with the use of encapsulant systems and because of their dependence upon the integrity of a lead-based paint film, the property owner or manager must arrange for regular monitoring and repairs, as needed. Visual monitoring should be performed 1 month and 6 months after application and no less often than every two years thereafter. If signs of wear or deterioration are apparent during any reevaluation examination, the monitoring should be increased to a quarterly basis for the next 6 months, then annually thereafter. In addition, residents should be instructed to notify management of the need for repairs on a timely basis. In some cities and States, regulatory reexaminations may be required, including sampling of settled dust for lead analysis. For example, as of the publication of these *Guidelines*, the Maryland Department of the Environment had the authority to inspect dwellings for a period of 1 year following application of an encapsulant. This is because the use of encapsulants is approved on a case-by-case basis, and the reevaluation provides a means of documenting their performance (Maryland, 2002).

For HUD-assisted housing that is subject to periodic reevaluation, monitoring of the performance of the encapsulation is recommended to be part of that reevaluation in order to determine if deterioration or failure of the encapsulation has occurred. Reevaluation is required if failure of encapsulation has been found during visual assessments or other observations by maintenance and repair workers since the previous reevaluation (see 24 CFR §35.1325 and § 35.1355(b)). If failure of encapsulation has been found, the encapsulation shall be repaired, or abatement or interim controls shall be performed.

IX. Recordkeeping

The owner and contractor should both maintain documentation of interim control or abatement measures. Because the lead is not removed, appropriate protective measures must be taken if the encapsulant fails or if the building is renovated or demolished. Although it would be possible to label existing lead-based painted surfaces prior to encapsulation, the warning would likely be hidden, since it would be covered by the encapsulant. A chemical reaction between the marking substance and the encapsulant could cause the encapsulant to fail. Therefore, drawings showing locations of lead-based paint should be mounted on a wall of a basement, storage closet, or utility room. Records of both the initial installation and reexaminations should be provided to a new owner at the time of property transfer. See Appendix 6 for disclosure rule requirements.

The following information describing the initial application should be included with the drawings kept in the building:

- ◆ Type of encapsulant and product name.
- ◆ Exact location of encapsulant.
- ◆ Product label and/or copy of manufacturer's technical product information.
- ◆ MSDS for all products used.
- ◆ Contractor name.
- ◆ Date of application.

The owner or local agency should keep the visual monitoring document. Each document should include the name of the person performing the periodic visual monitoring, the date of the visual monitoring, the condition of coating and signs of wear or deterioration, and results of any leaded dust tests performed. If failure was observed during visual assessments or other observations by maintenance and repair workers, or during periodic monitoring and reevaluation, the reasons for failure (if known), corrective actions recommended or taken to repair failures, and any other information pertinent to the maintenance of the encapsulant should be included. Form 13.2 may be used for this purpose.

Form 13.2 Lead-Based Paint Encapsulation Visual Monitoring Form

Name of Person Performing Visual Monitoring _____

License or Certificate Number (If Applicable) _____

Complete Address of Dwelling _____

Date Encapsulant was Applied _____

Date of Last Evaluation _____

Today's Date _____

Room	Surface Location	Substrate	Name and/or Formulation of Encapsulation	Observations	Pass/ Fail

Signature _____

Printed Name _____

References

HUD, 1991. U.S. Department of Housing and Urban Development, *The HUD Lead-Based Paint Abatement Demonstration (Federal Housing Administration)*, prepared by Dewberry & Davis, HC-5831, Washington, DC.

HUD, 1990b. U.S. Department of Housing and Urban Development, *A Comprehensive and Workable Plan for the Abatement of Lead-Based Paint in Privately-Owned Housing: A Report to Congress*, Washington, DC, December 7, 1990.

Maryland DER, 2002. *Procedures for Abating Lead Containing Substances from Buildings*, COMAR 26.02.07, Title 26, Maryland Department of the Environment Regulations, Baltimore, Maryland.

NBS, 1973. National Bureau of Standards, U.S. Department of Commerce, *FlexiWall Systems Features and a Comparison of Its Advantages Over Other Systems per National Bureau of Standards Tests*, NBS Technical Note 808, Washington, DC. [Now known as National Institute for Standards and Technology, or NIST.]

Chapter 14: Cleaning

HOW TO DO IT	14-3
I. Introduction.....	14-5
A. Performance Standard	14-5
B. Small Dust Particles	14-6
C. Difficulties in Cleaning.....	14-6
1. Worker Inexperience.....	14-6
2. High Dust-Producing Methods and/or Inadequate Containment.....	14-7
3. Rough Surfaces	14-7
4. Rushing to Meet Tight Deadlines.....	14-7
II. Coordination of Cleaning Activities.....	14-7
A. Checklist	14-7
B. Equipment Needed for Cleaning	14-8
C. Waste Handling and Disposal	14-8
III. Cleaning Methods.....	14-9
A. Vacuums: HEPA vs. non-HEPA	14-9
B. HEPA Vacuums	14-10
C. Emptying the Vacuum	14-11
D. Wet Cleaning	14-12
IV. Cleaning Procedures Before and During the Work.....	14-13
A. Cleaning Before Work Begins.....	14-14
B. Ongoing Cleaning During the Job	14-14
C. Daily Cleaning	14-14
1. Large Debris	14-15
2. Dust and Small Debris	14-15
3. Exterior Cleaning	14-15
4. Worker Protection Measures	14-16
5. Maintaining Containment.....	14-16
V. Final Cleaning Procedures.....	14-16
A. Decontamination of Workers, Supplies and Equipment.....	14-16
B. Cleaning and Removal of Protective Sheeting	14-17
C. Vacuuming and Wet Cleaning.....	14-17
D. Supervisor's Preliminary Visual Inspection.....	14-19
E. Surface Painting or Sealing of Non-Floor Surfaces.....	14-19
F. Sealing Floors	14-19
G. Final Wet Cleaning, EPA Cleaning Verification, and Possible Pre-Clearance Dust Testing.....	14-19
H. Clearance.....	14-21

I. Recleaning After Clearance Failure 14-21

REFERENCES 14-22

FIGURES

Figure 14.1 There are many brands of HEPA vacuums on the market..... 14-8

Figure 14.2 Vacuum with a HEPA filter and special attachments..... 14-10

Figure 14.3 Sizes of HEPA vacuums and attachments. 14-11

Figure 14.4 Three-bucket cleaning system..... 14-13

Figure 14.5 HEPA vacuum and wet wash technology. 14-13

Figure 14.6 Removing large debris. 14-15

Figure 14.7 Exterior clean up. 14-16

Figure 14.8 Vacuuming the floor containment. 14-17

Figure 14.9 Inspecting for completeness of the work performed. 14-19

Figure 14.10 The HEPA Vacuum-Wet Wash-HEPA Vacuum Cycle Helps,
Meet Clearance Standards..... 14-20

Figure 14.11 Wet Cycle Requires Washing All Surfaces with Suitable Detergents..... 14-20

Figure 14.12 Use a Three-Bucket System and Then HEPA Vacuum,
Again to Minimize Recontamination 14-20

Figure 14.13 HEPA vacuum all surfaces a final time..... 14-20

TABLE

Table 14.1 Summary Guidance on Cleaning Methods by Dustiness of Work
and Condition of the Surface. 14-18

Chapter 14: Cleaning

How to Do It

1. **Include cleaning in plans for the work.** Include written step-by-step procedures for precleaning, cleaning during the job, and daily and final cleanings in the project design or specifications, using information contained in this chapter. Assign responsibilities to specific workers for cleaning and for maintaining cleaning equipment. Have sufficient cleaning equipment and supplies *before* beginning work, including:
 - ◆ Detergent
 - ◆ Waterproof gloves
 - ◆ Disposable rags
 - ◆ Mops
 - ◆ Buckets
 - ◆ Vacuum (preferably HEPA-equipped) with attachments (crevice tools, beater bar for cleaning rugs, etc.)
 - ◆ Plastic bags for disposal of debris and heavy duty protective sheeting (of sufficient thickness to prevent puncture)
 - ◆ Debris containers (heavy duty plastic bags are adequate for most jobs)
 - ◆ Containers for dirty wash water
 - ◆ Shovels
 - ◆ Rakes
 - ◆ Water-misting sprayers
 - ◆ Heavy duty polyethylene sheeting (or equivalent) of sufficient thickness to prevent puncture (e.g., 6 mil).
2. **Restrict access to work area.** Do not allow residents to enter the work area until cleaning is completed and clearance is established.
3. **Clean before starting work.** If contamination is extensive, conduct precleaning of the dwelling unit and furnishings, if needed, before beginning paint-disturbing work. Move and/or cover all furniture and other objects.
4. **Conduct ongoing cleaning during the work.** Conduct ongoing, continual cleaning during high-dust jobs, including regular removal of large and small debris and dust. Decontamination of all tools, equipment, and worker protection gear is required before such items are removed from containment areas. Electrical equipment should be wiped and vacuumed, not wetted down, to minimize electrocution hazards.

5. **Clean at the end of each work day.** For high-dust jobs, schedule sufficient time (usually 30 minutes to one hour) for a complete daily cleaning, starting at the same time near the end of each work day after paint-disturbing activity has ceased.
6. **Wait one hour before final cleaning.** For final cleaning, wait at least 1 hour after active paint-disturbing activity and other dust-generating work has ceased to let dust particles settle.
7. **Clean and remove protective sheeting used for dust containment.**
8. **Use both vacuuming and wet cleaning.** Clean all surfaces, using the two basic cleaning methods, vacuuming and/or wet cleaning. Cleaning procedures may vary, depending on the amount of dust generated by the job and the smoothness of the surfaces to be cleaned. A three-phase, vacuum-wet cleaning-vacuum cycle is recommended for high-dust jobs with some rough or porous surfaces. For low-dust jobs with all smooth surfaces, wet cleaning may be adequate to pass clearance. Surfaces that are badly soiled often require extra manual effort, involving hand wiping until no more visible dirt comes up. Other cleaning methods are acceptable, as long as clearance criteria are met and workers are not overexposed.
9. **A HEPA vacuum is required if a vacuum is used.**
10. **Follow the cleaning sequence, "ceiling to floor and out the door."** For high-dust jobs, vacuum all surfaces in the room (ceilings, walls, trim, interior window sills, window troughs, hard surface floors, and other horizontal surfaces). Start with the ceiling and work down, moving toward the entry door ("ceiling to floor and out the door"). Completely clean each room before moving on. For low-dust jobs, it is not necessary to clean ceilings and walls, except that they should be cleaned if they were the surfaces on which the work was done. See Chapter 8 for a description of low-dust and high-dust jobs.
11. **Use a common detergent, not TSP (Trisodium Phosphate).** Use a standard household detergent, not a high-phosphate detergent, to dislodge any ground-in contamination. Use either the three-bucket system described in this chapter, or a use-once-and-toss system, as also described below. If buckets are used.
12. **Inspect visually.** After final cleaning, the supervisor should perform a visual inspection to ensure that all visible dust and debris has been removed. Reclean if necessary.
13. **Paint and/or seal, if necessary.** Paint or otherwise seal treated surfaces and interior floors, if necessary.
14. **Final wet cleaning.** After painting that has followed high-dust jobs, conduct a final wet cleaning of horizontal surfaces.
15. **Clearance.** Workers should stay out of cleaned rooms until after the clearance examination. Conduct a clearance examination (see Chapter 15). (Clearance, while recommended by HUD, is not required by regulations in certain circumstances, such as for *de minimis* projects under HUD's Lead Safe Housing Rule or under the EPA's Renovation, Repair, and Painting Rule., which requires cleaning verification for most projects; see Chapter 11.)
16. **Repeat cleaning and clearance (or cleaning verification), if necessary. Continue clearance testing (or cleaning verification) until the dwelling unit or work area passes.** If the unit fails, repeat cleaning of all of the surfaces that failed and all other surfaces represented by the surfaces that failed.
 - ◆ As an incentive to conduct ongoing cleaning and a thorough final cleaning, the cost of repeated cleaning after failing to pass clearance or cleaning verification should be borne by the contractor, not the owner, as a matter of the job specification.

I. Introduction

This chapter describes cleaning procedures to be employed before, during and following lead-based paint abatement, interim controls and other renovation or maintenance work that may create lead-contaminated dust. Dust removal as an interim control measure is covered in Chapter 11.

All lead hazard control activities and many other paint-disturbing jobs can produce dangerous quantities of lead-contaminated dust. Unless this dust is properly removed, a dwelling unit may be more hazardous after the work is completed than it was originally. Whenever possible, ongoing and daily cleaning of settled dust during lead hazard control and renovation projects is recommended. Ongoing and daily cleaning are also necessary to minimize worker exposures by removing excess dust from the work area.

Cleaning is the process of removing visible dust and debris *and* dust particles too small to be seen by the naked eye. Removal of lead-based paint hazards in a dwelling unit will not make the unit safe unless excessive levels of leaded-dust are also removed. This is true regardless of whether the dust was present before the work or generated by the work itself. Improper cleaning can increase the cost of a project considerably because additional cleaning and clearance sampling will be necessary. However, cleaning and clearance can be achieved routinely if care and diligence are exercised.

The cleaning methods and procedures described in this chapter are for hard surfaces. Workers should not attempt to clean carpets or rugs following lead hazard control or other paint disturbing work unless they know that the carpets are new and therefore are not likely to contain lead-contaminated dust embedded in the fibers and backing, or unless the workers are prepared to spend hours vacuuming the carpeting over and over again until the deeply embedded dust is removed. Vacuuming an old carpet may bring some of the embedded dust to the surface of the carpet, increasing the dust-lead loading levels on the surface and thus increasing the likelihood that children will be exposed to lead in the dust and that the carpet will *not* pass clearance (Ewers, 1994). Therefore it is better to clean and carefully remove the protective sheeting that is over the carpet (as described later in this chapter), and then have clearance dust-wipe sampling performed on the carpet. If lead levels on the surface of the carpet are found to exceed the clearance standard (which is the same as the hazard standard in EPA regulations), it will be necessary to either thoroughly clean the carpet or dispose of it. See Section V.B.2 of Chapter 11 for guidance on dust removal from carpets.

A. Performance Standard

The cleaning methods described in this chapter are designed to achieve clearance. (The clearance examination, which includes a visual assessment and dust sampling, is described in Chapter 15.) Although these cleaning methods are feasible and have been shown to be effective in meeting clearance standards, other methods may also be used if they are safe and effective. This performance-oriented approach should stimulate innovation, reduce cost, and ensure safe conditions for both residents and workers.

According to EPA (40 CFR 745.227(d)(8)(viii)) and the HUD regulations (24 CFR 35.1320(b)(2)(i)) that follow the EPA regulations, the permissible amount of lead in dust remaining on each of the following surfaces following lead hazard control work – the clearance standards – must be less than the following levels:

- ◆ 40 $\mu\text{g}/\text{ft}^2$ on floors (both hard-surfaced and carpeted),
- ◆ 250 $\mu\text{g}/\text{ft}^2$ on interior window sills (stools), and

- ◆ 400 µg/ft² on window troughs (the area where the sash sits when closed, plus the area of the exterior sill between the sash and the frame for the screen and/or storm window, if present).

These levels are based on wipe sampling. They apply to single-surface wipe samples and to composite wipe samples with only two subsamples. To evaluate the results of a composite sample with more than two subsamples, the standards listed above must be divided by one-half the number of subsamples. (Note that these *Guidelines* do not recommend the use of composite wipe sampling; see Chapter 15.)

If state, local or tribal standards are more stringent, they apply. Note that EPA and HUD require clearance of window troughs for abatement and for other lead hazard control work covered by HUD's Lead Safe Housing Rule above *de minimis* amounts. A clearance examination includes wipe sampling of window troughs as well as interior window sills and floors.

Clearance is not easily attained. Over 20 percent of the dwellings enrolled in the evaluation of the HUD Lead Hazard Control Grant Program failed to pass clearance on the first try, and the clearance levels applicable at the time of the study were at least twice as high as those listed above and thus less difficult to achieve (NCHH, 2004).

B. Small Dust Particles

Dust particles that are invisible to the naked eye remain on surfaces after ordinary cleaning procedures. A visibly clean surface may contain unacceptably high levels of lead in dust particles and require special cleaning procedures.

C. Difficulties in Cleaning

Although cleaning is an integral and essential component of any lead hazard control activity, it is also the part of the activity that when conducted improperly is most likely to cause clearance failure. Common causes for this failure include worker inexperience, high dust-producing methods, rough surfaces, and tight deadlines.

1. Worker Inexperience

To understand the level of cleanliness required to meet the established clearance standards, workers often require a significant reorientation to cleaning. Many construction and maintenance workers are used to cleaning only dust that they can see, not the invisible dust particles that are also important to remove.

Any worker performing cleaning for either clearance or cleaning verification needs training and hands-on practice in the stringent levels of cleaning required to pass clearance or cleaning verification.

Many of the cleaning methods described in this chapter are not standard, traditional procedures for general home improvement contractors and maintenance crews. Therefore, owners and managers must ensure that contractors and crews follow the specialized cleaning procedures recommended herein or specially designed alternative procedures, even though some steps may appear to be redundant or unnecessary. These methods have been shown to be feasible and effective in many situations, and skipping steps in the cleaning procedures may increase the possibility of failing clearance and harming children.

2. High Dust-Producing Methods and/or Inadequate Containment

High dust-generating methods during the hazard control or renovation work, inadequate dust containment, and poor work practices can all make achievement of clearance particularly difficult. Dust generated by the work should be contained, to the extent possible, to the inside of work areas. Floors and any furnishings left in the work area should be carefully covered with impermeable protective sheeting. Inadequately constructed or maintained containment or poor work practices will result in additional cleaning efforts, due to dust that has blown out or been tracked out of the work area. Work practices necessary to prevent spreading of dust throughout a dwelling (e.g., by tracking dust out of work areas) are essential. See Chapter 8 for guidance on worksite preparation and other work practices.

3. Rough Surfaces

It is often difficult to dislodge dust in the crevices of rough, pitted or cracked surfaces, yet small amounts of dust in such locations can be picked up in clearance wipe samples and cause clearance failure. Making surfaces smooth and cleanable increases the likelihood of achieving clearance.

4. Rushing to Meet Tight Deadlines

Daily and final cleanings have sometimes been compromised due to project deadlines, since cleaning comes at the end of the job. Hurried efforts often result in clearance failure. Delayed and over-budget projects are often the result of repeated, unplanned recleanings that are necessitated by inadequate containment and careless work practices, including rushed clean-ups.

II. Coordination of Cleaning Activities

A. Checklist

The owner or contractor may use the following cleaning checklist before any lead hazard control or renovation activity.

- ◆ Is the critical importance of cleaning understood by the project supervisor / certified renovator / abatement supervisor, and all workers on the job?
- ◆ Have all workers been trained for hazard control work or lead-safe work practices?
- ◆ Have all workers carefully studied the step-by-step procedures for precleaning before the work begins (if needed), in-progress cleaning, and daily and final cleanings?
- ◆ Have the before-work, daily, and final cleanings been scheduled properly and coordinated with the other participants in the project?
- ◆ Have cleaning equipment, materials and supplies been obtained?
- ◆ Do the workers know how to operate and maintain special cleaning equipment, do they have directions for the proper use of all cleaning materials, and are they receiving adequate supervision of their cleaning activities?

- ◆ Are all workers properly protected during the cleaning processes (see Chapter 9)?
- ◆ Have provisions been made to properly handle and dispose of waste (see Chapter 10)?
- ◆ Have visual inspections and clearance testing (or cleaning verification) been arranged (see Chapter 15)?
- ◆ Are the clearance (or cleaning verification) criteria to be met fully understood?
- ◆ Have all appropriate surfaces been properly painted or otherwise sealed?

B. Equipment Needed for Cleaning

The following equipment is needed to conduct cleaning: a high-efficiency particulate air (HEPA) filter vacuum cleaner, and attachments (crevice tools, beater bar or agitator head for cleaning carpets and rugs, etc.) (see Figure 14.1); detergent; water-proof gloves; rags, mops, and buckets; heavy-duty plastic bags (preferably 6-mil) for debris; waste water containers; shovels (and rakes, if needed) for debris removal; water-misting sprayers; and disposable, impermeable protective sheeting, such as polyethylene plastic sheeting of a thickness to prevent puncture (e.g., 6-mil).



FIGURE 14.1 There are many brands of HEPA vacuums on the market.

C. Waste Handling and Disposal

Generally, dirty water used in cleaning should be disposed of down a toilet. Do not pour dirty water onto the ground or down a storm sewer. Vacuum and/or wet clean protective sheeting. Vacuum contaminated disposable clothing. Wrap or bag (with heavy-duty plastic) disposable clothing and protective sheeting, architectural debris, paint strippings, paint chips and dust, vacuumed debris and vacuum filters, rags, and other material. Seal the packages with tape and store them temporarily in a secure location (such as a locked large metal bin for refuse, e.g., a Dumpster®). Dispose of the waste in an appropriate State-permitted solid waste facility, unless the waste is exempt from that requirement. See the next paragraph and Chapter 10 for further information on waste disposal.

EPA has stated that waste generated by lead-based paint activities in housing falls under the household waste exemption in the Resource Conservation and Recovery Act (RCRA) (EPA, 2000b). The household waste exemption applies to waste generated by contractors as well as to waste generated by residents, and it applies to all lead-based paint activities, including abatement, interim control, and renovation and remodeling of housing. Types of housing included in the household waste exemption are single-family homes, apartment buildings, public housing, and military barracks. HUD and EPA both recommend that the lead-safe practices described above and in Chapter 10 be followed to reduce the likelihood that household waste will contaminate the environment.

States and local governments may institute hazardous waste requirements applicable to lead activities in housing. Owners and contractors should determine what, if any, state or local regulations apply, and should comply with them.

III. Cleaning Methods

Two basic cleaning methods have proven effective, especially when used concurrently: (1) vacuuming, using a high-quality vacuum cleaner equipped with a HEPA exhaust filter, and (2) wet cleaning with a household detergent and rinsing. Trisodium phosphate (TSP) is not recommended, as explained below in Section III.D. A proven cleaning procedure is a three-pass system, in which the surface is first vacuumed to remove as much dust and small debris as possible, then wet-cleaned to dislodge fine dust, and finally vacuumed again to remove any remaining particles. However, it may not be necessary to use all three steps on all surfaces. As explained in Section V below, research indicates that the way these methods should be used depends on whether the work was a high-dust or low-dust job and whether the surfaces being cleaned are smooth or rough (Dixon, 2004; California Dept. of Health Services, 2004).

A. Vacuums: HEPA vs. non-HEPA

If a vacuum cleaner is used during lead hazard control projects, renovation projects, or other work covered by OSHA regulations, the vacuums must be a HEPA vacuum. This section provides technical information on the various types of vacuum cleaners.

HEPA vacuums differ from conventional vacuums in that they contain high-efficiency filters that are capable of trapping extremely small, micron-sized particles. These filters can remove particles of 0.3 microns or greater from air at 99.97 percent efficiency or greater. (A micron is 1 millionth of a meter, or about 0.00004 inches.) Some vacuums are equipped with an ultra-low penetration air (ULPA) filter that is capable of filtering out particles of 0.13 microns or greater at 99.9995 percent efficiency. However, these ULPA filters are slightly more expensive, and may be less available than HEPA filters. (Note that, when HEPA vacuums are specified by regulations or specifications, ULPA filter vacuums may be used because of their greater dust collection efficiency.)

Experts have recommended using HEPA vacuums to cleanup leaded-dust because conventional vacuums, without the high efficiency filter, may send very fine lead-dust particles out the exhaust and back into the indoor environment. One study in 1992 supported this view (CMHC, 1992). More recent studies, however, have found that the difference in collection efficiency between HEPA and non-HEPA vacuums is not significant (California Department of Health Services, 2004; Rich, 2002; and Yiin, 2002).

There is more to a vacuum than the filter. Other important factors that determine the effectiveness of a vacuum are particle lifting velocity (which is a function of the motor, the design of the suction tool, and the extent to which the rest of the system does not release air before it is supposed to), quality of construction (which may determine the durability of the machine and whether there are air pressure leaks before the filtration), and whether the vacuum has special tools, such as a crevice tool (see Figure 14.1). These *Guidelines* recommend that a high-quality HEPA vacuum be used if possible; however, a high-quality household or commercial vacuum should be used if a HEPA vacuum is not available. The California study cited in the previous paragraph found that a HEPA vacuum was actually less effective in removing dust-lead from vinyl floors than non-HEPA vacuums, probably because the suction tool was not well designed for the job. Also, filters are available that, while not HEPA, are better than those that formerly were standard on household and commercial vacuums. One additional benefit of a HEPA filter is that it may catch other contaminants in the residential environment, such as allergens, in addition to very fine lead particles.

B. HEPA Vacuums

This section provides background information on HEPA vacuums.

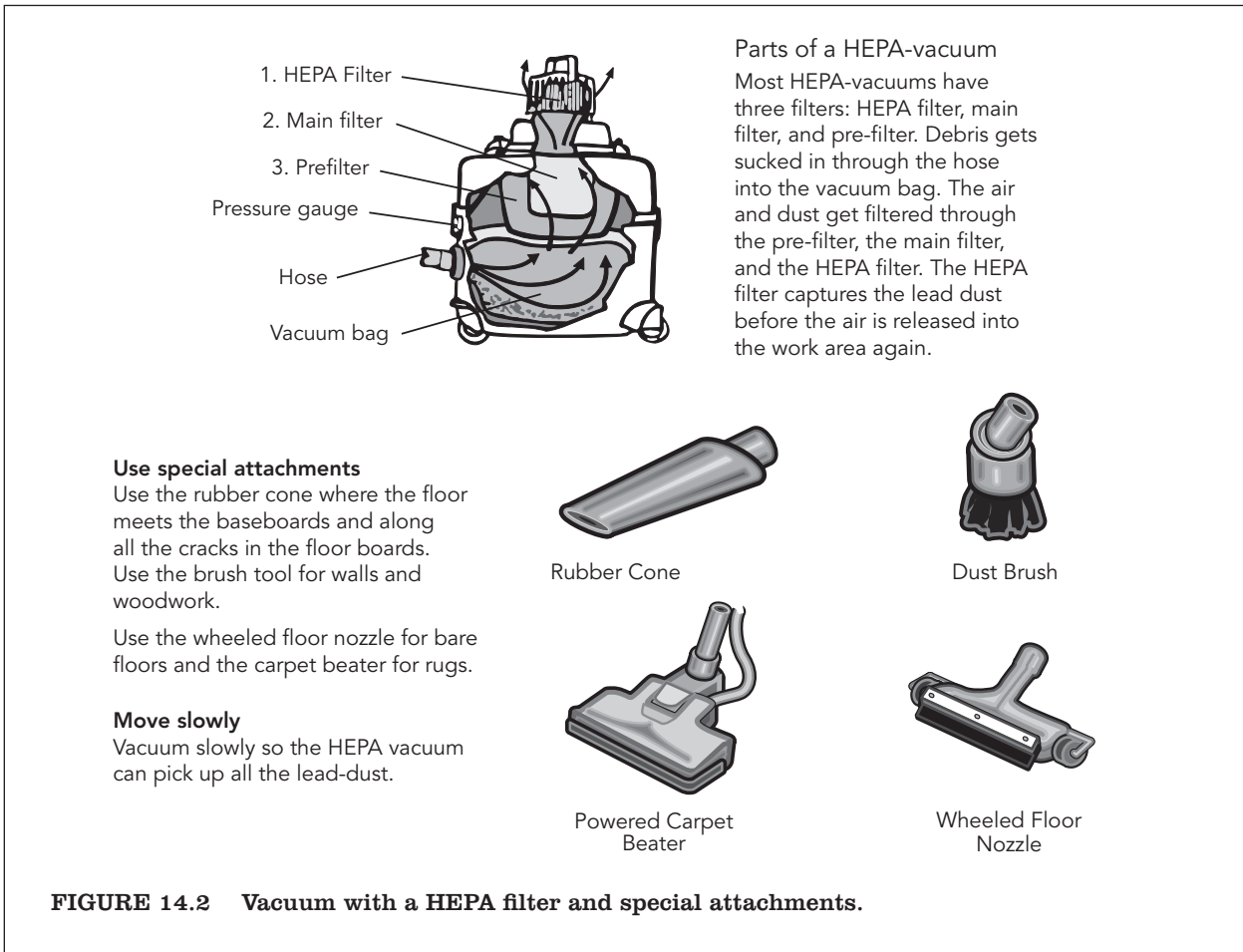
Operating Instructions

There are numerous manufacturers of HEPA vacuums. Although all HEPA vacuums operate on the same general principle, they may vary considerably with respect to specific procedures, such as how to change the filters. To ensure the proper use of equipment, the manufacturer’s operating instructions should be carefully followed and if possible, training sessions arranged with the manufacturer’s representative.

Although HEPA vacuums have the same “suction” capacity as ordinary vacuums that are comparably sized, their filters are more efficient. Improper cleaning or changing of HEPA filters may reduce the vacuum’s suction capability.

Special Attachments

Because the HEPA vacuum will be used to vacuum surfaces other than floors, operators should buy attachments and appropriate tool kits for use on different surfaces (such as brushes of various sizes, crevice tools, angular tools, etc.), as is true with conventional vacuums (see Figure 14.2).



Selecting Appropriate Size(s)

HEPA vacuums are available in numerous sizes, ranging from a small lunch bucket-sized unit, which may be carried like a backpack, up to truck-mounted systems. Two criteria for size selection are the size of the job and the type of electrical power available. Manufacturer recommendations should be followed (see Figure 14.3).

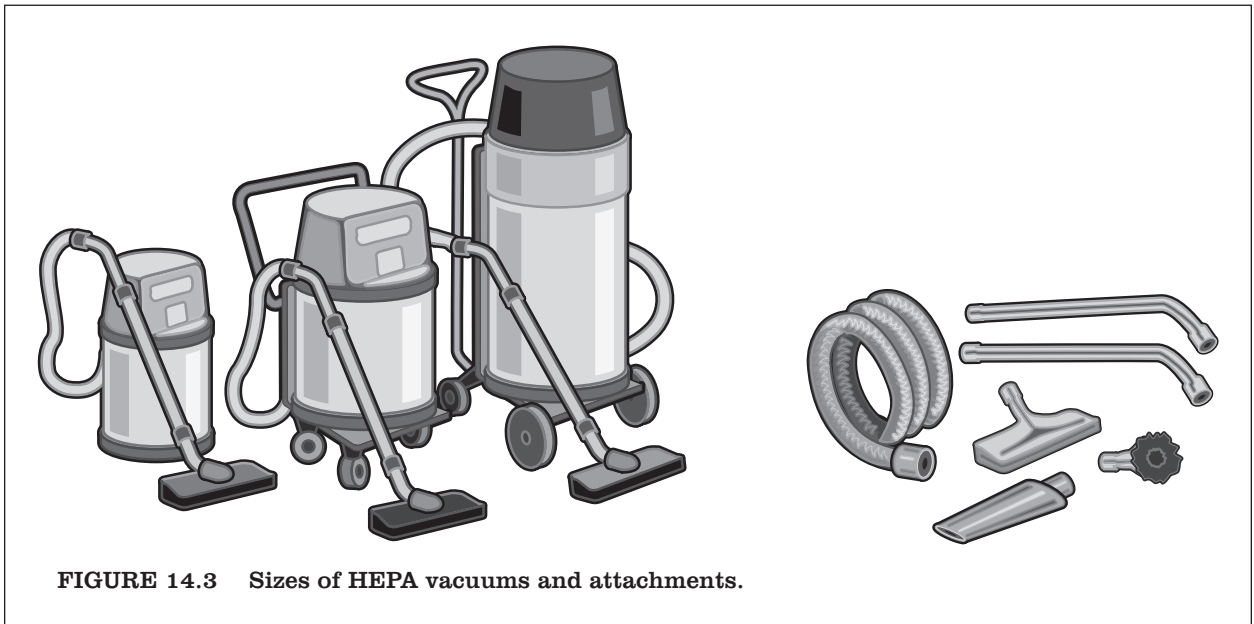


FIGURE 14.3 Sizes of HEPA vacuums and attachments.

Prefilters

HEPA filters are usually used in conjunction with a prefilter or series of prefilters that trap the bulk of the dust in the exhaust air stream, particularly the larger particles. The HEPA filter traps most of the remaining small particles that have passed through the prefilter(s). All filters must be maintained and replaced or cleaned as specified in the manufacturer's instructions. Failure to do so may cause a reduction in suction power (thus reducing the vacuum's efficiency and effectiveness). Failure to change prefilters may damage the vacuum motor and will also shorten the service life of the HEPA filter, which is far more expensive than the prefilters.

Wet-Dry HEPA Vacuums

Wet-dry HEPA vacuums are equipped with a special shut-off float switch to protect the electrical motor and the HEPA filter from water contact. Some hazard control contractors have found these vacuums to be particularly effective in meeting clearance standards and in avoiding damage to vacuum equipment.

C. Emptying the Vacuum

Used filters and vacuumed debris should be handled and disposed of in accordance with guidance provided in Chapter 10. Emptying should be done in the containment area or in a secure

and controlled space off-site (such as at the contractor's facility). The vacuum should be placed on a large sheet of plastic to contain dust and debris released during the opening, emptying and replacement steps. Vacuum users should use extreme caution when opening the vacuum for filter replacement or debris removal to avoid accidental release of accumulated dust into the environment. This may occur, for example, if the vacuum's seal has been broken and the vacuum's bag is disturbed. Operators should wear protective clothing and appropriate respiratory protection when performing this maintenance function

D. Wet Cleaning

It is recommended that a general all-purpose household cleaner be used for wet cleaning. Cleaners made specifically for lead may also be useful, although one study found that lead specific cleaners performed no better than all-purpose household cleaners, and that no published studies have shown lead-specific cleaners to be more effective than all-purpose cleaners (Lewis, 2006). Cleaning with water alone can also be effective, but detergents and lead-specific cleaners are recommended because they probably keep dust and soil in suspension better than plain water (EPA, 1997a; EPA, 1998). HUD does not recommend trisodium phosphate (TSP). Not only has TSP been banned in some areas because of negative effects on the ecology of aquatic systems, but research indicates that phosphate content is not associated with effectiveness in removing lead-contaminated dust from residential surfaces (EPA, 1997a; EPA, 1998, Lewis, 2006).

Research also indicates that the effort put into the cleaning, i.e., the amount of pressure applied to the surface and the thoroughness of the cleaning, may be more important than the choice of cleaning agent (EPA, 1997a). Note that whenever a wet cleaner is used, a small area of the surface should be tested to make sure that it does not damage the surface or its coloring. If so, another wet cleaner should be used.

Proper procedures for using detergents include the following steps:

Manufacturer's Dilution Instructions

Users of cleaning agents for leaded dust removal should follow manufacturer's instructions for the proper use of a product, especially the recommended dilution ratio.

Appropriate Cleaning Equipment

Because a detergent may be used to clean leaded dust from a variety of surfaces, several types of application equipment are needed, including cleaning solution spray bottles, wringer buckets, mops (including several clean mop heads), brushes, and rags. Follow manufacturer's instructions for the equipment used. Using the proper equipment on each surface is essential to the quality of the wet wash process.

Wet Cleaning Procedures

Some wallpaper surfaces may be damaged by wet washing with detergents. Test a small area first. If it appears that damage will occur, try another detergent, use plain water, or as a last resort clean by repeated vacuuming only.

Use of string mops is recommended for floors. Sponge mops may only push the lead around on the floor, not pick it up. A three-bucket system is recommended with mops (see Figure 14.4). The first bucket contains the cleaning solution, the second includes a mop squeezer, and the third



FIGURE 14.4 Three-bucket cleaning system.

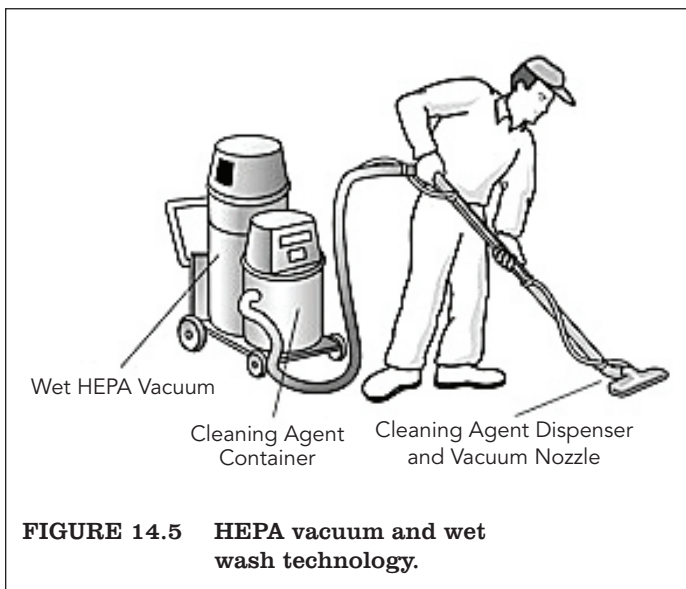


FIGURE 14.5 HEPA vacuum and wet wash technology.

contains rinse water. Use a clean mop head for rinsing. Three-bucket system is also discussed below under Section V.E, Final Cleaning.

Some experienced contractors have used, instead of the three-bucket mopping system, a “wet, wipe and toss” procedure. This method requires a large quantity of clean rags, which are put into a bucket of detergent and water solution to wet them. The worker pulls a rag from the bucket, wrings it out over the bucket, *wipes* clean an area of about 16 sq. ft., *tosses* the used rag away, pulls another rag, and so on. If the detergent requires rinsing, repeat with clean water. For sills, troughs, counters, shelves, walls and tight floor spaces like behind toilets, the wet wipe and toss method is the best alternative to the mop. Some contractors prefer the method even for large floor areas. A major advantage is that it avoids the potential problem of recontaminating the area by cleaning with dirty water. This method may also use less water than a mop, which can be an advantage for some household areas. The rags are commercially available, disposable cloth scraps or paper products. Cloth rags usually are not cleaned and reused because of the risk of contaminating other laundry (White, 2003). Alternatively, some people use wet-dry HEPA vacuums (see Figure 14.5).

Changing the Cleaning Mixture

Many manufacturers of cleaners will indicate the surface area that their cleaning mixture will cover. To avoid recontaminating an area by cleaning it with dirty water, users should follow manufacturer-specified surface area limits. (Note that this issue is largely avoided if the “wet, wipe and toss” method is used, because each rag is used only once.) However, regard-

less of manufacturers’ recommendations, the cleaning mixture should be changed after its use for each room. As a rule of thumb, 5 gallons should be used to clean no more than 1000 square feet. Dirty cleaning mixture should be handled and disposed of in accordance with guidance provided in Chapter 10. Wash water should never be poured onto the ground. It is sometimes filtered, and usually poured down a toilet.

IV. Cleaning Procedures Before and During the Work

The special cleaning procedures to be followed *before and during* a hazard control or renovation project are discussed in chronological order below. Skipping steps in the process may result in failure to meet clearance standards.

A. Cleaning Before Work Begins

Precleaning (i.e., cleaning conducted before lead hazard control or other paint-disturbing work is begun) is necessary only in dwelling units or common areas that are heavily contaminated with lead in dust and paint chips. Precleaning involves the removal of debris and paint chips, followed by vacuuming (see Figure 14.4). These steps may be followed by removal of occupant personal possessions, furniture, or carpeting, depending on the worksite preparation being used (see Chapter 8). If the furniture will not be cleaned, it should be removed from the area and/or covered with protective sheeting prior to beginning the precleaning procedure. Carpeting (including rugs) should always be misted before removal to control the generation of hazardous dust.

It is usually the resident's responsibility to remove most of his or her personal possessions. However, if necessary, owners or project management should be prepared, with necessary boxes, packing materials, and staff, to complete this activity before lead hazard control work begins. As a last resort, the contractor or the maintenance staff may pack any remaining belongings and carefully seal and move the boxes from the work area.

Once the residents' possessions that can be removed from the work area have been removed, the contractor shall ensure that the residents leave the work area and do not return until after clearance (or cleaning verification) has been passed.

Clearance should be conducted after final cleaning but *before* resident's items are moved back in. (See Chapter 15.) Following cleaning and clearance, the contractor should return all resident-owned items to their appropriate places. Leaving these tasks to the contractor or the management may be expensive and inefficient, since the contractor will need to be insured against the possibility that the occupant's belongings may be damaged.

B. Ongoing Cleaning During the Job

On all jobs, it is good practice to regularly clean the work area and the travel pathways used by workers, by removing debris and vacuuming dust during the work shift, in order to keep the areas free of excessive accumulations of dust and/or debris.

For high-dust jobs, when a large amount of paint chips or dust is being generated, continual debris removal and vacuuming of dust during the work day may be necessary to minimize worker exposure and tracking of dust and paint chips from one area to another. Extra attention should be paid to ongoing cleaning so that daily clean-up goes quickly.

Research conducted shortly before the publication of this edition of these *Guidelines* on whether if differences exist between two new and two older methods for removal of lead-contaminated dust from three wood surfaces of varying roughness or texture found that the reduction in lead dust achieved by vacuuming and wet wiping, the traditional method, was somewhat greater and more consistent than the electrostatic dry cloth and wet Swiffer-brand mop, a newer method. (Lewis, 2012) As noted in that paper, the wipe product industry continues to develop products; future cloths may have higher dust reduction efficiencies.

C. Daily Cleaning

Cleaning activity should be scheduled at the end of each work day when all active work has ceased, whether or not this is a regulatory requirement for the particular job. Sufficient time should be allowed for a thorough and complete cleaning, usually about 30 minutes to an hour, less if cleaning has been done throughout the work shift. (If work is being done in multiple shifts, it is recommended

that there be a cleanup at the end of each shift.) Daily cleaning helps achieve clearance dust-lead levels by minimizing problems that may otherwise occur during final cleaning, and it limits worker exposures. Daily cleaning can be skipped within vacant buildings. Daily cleaning is essential when occupants will return in the evening to occupy spaces outside the containment area. Under no circumstances should dust or debris from the project, or protective sheeting be left outside overnight, even if the dwelling is vacant. (Storing bagged dust and debris from the project, and protective sheeting in secure containers outside is permissible.) Daily cleaning should consist of:

- ◆ Wrapping or bagging dust and debris from the project, and storing it in a secure area
- ◆ Vacuuming protective sheeting on floors and furnishings
- ◆ Vacuuming other horizontal surfaces
- ◆ Vacuuming and wet cleaning floors of hallways and rooms used as pathways by workers to travel outside the work area, if such spaces are accessible to residents during non-work hours
- ◆ Cleanup of exterior debris and paint chips, and removal of exterior protective sheeting
- ◆ Patching and repairing protective sheeting
- ◆ Putting any protective sheeting that is removed in a secure place

1. Large Debris

Large demolition-type debris (e.g., doors, windows, trim) should be wrapped in heavy duty (6-mil plastic or similar sheeting that will resist puncture), sealed with tape, and moved to a secure area on the property designated for waste storage. All sharp corners, edges, and nails should be hammered down to prevent injury and minimize the tearing of plastic. It is not necessary to wrap each individual piece of debris in plastic if the entire load can be wrapped. A secure area either outside or inside the property should be designated as a temporary waste-storage area. Covered, secured, and labeled dumpsters placed on or near the property may be used. (See Chapter 10.)

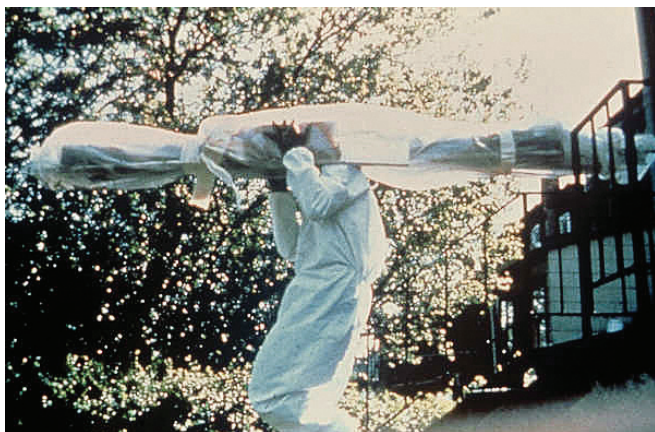


FIGURE 14.6 Removing large debris.

2. Dust and Small Debris

Dust and small debris should be vacuumed and wet wiped or mopped, or, alternatively, after being misted with water, it should be swept up, collected, and disposed of properly. The swept debris should be placed in heavy duty (double 4-mil or single 6-mil polyethylene plastic bags or equivalent), properly sealed, and moved to the designated trash storage area. Trash bags should not be overloaded, as overloaded bags may rupture or puncture during handling and transport.

3. Exterior Cleaning

Exterior and interior areas potentially affected by exterior lead hazard control or other paint-disturbing work should

be protected with a containment system (see Chapter 8). Because weather can adversely affect the efficacy of exterior containment, the protective sheeting on the ground should be removed at the end of each work day. On a daily basis, as well as during final cleaning, the immediate exterior area should be examined visually to ensure that no debris has escaped containment. Any such debris should be raked or vacuumed and placed in single 6-mil or double 4-mil plastic bags, which should then be sealed and stored along with other contaminated debris (see Figure 14.7). Vacuuming is appropriate for hard exterior surfaces, but not for soil.

4. Worker Protection Measures

Worker protection measures are discussed in Chapter 9. Studies indicate that during daily cleaning activities, especially while sweeping, lead hazard control workers may be exposed to high levels of airborne dust. When appropriate, workers should wear protective clothing and equipment respiratory protection.

5. Maintaining Containment

The integrity of the protective sheeting used in a lead hazard control project should be maintained. During their daily cleaning activities, workers should monitor the sheeting and immediately repair any holes or rips with durable sheeting (e.g., 6-mil polyethylene) and duct tape.



FIGURE 14.7 Exterior clean up.

V. Final Cleaning Procedures

Before treated surfaces can be painted or sealed, final cleaning should be completed. Because airborne dust requires time to settle, the final cleaning process should start no sooner than 1 hour after active lead hazard control or other paint-disturbing work has ceased in the room.

A. Decontamination of Workers, Supplies and Equipment

Decontamination is necessary to ensure that worker's families, other workers, and subsequent properties do not become contaminated. Specific procedures for proper decontamination of equipment, tools and materials prior to their removal from containment areas should be implemented, as described below and in Chapter 9.

Work clothing, work shoes, and tools should not be placed in a worker's automobile unless they have been laundered, cleaned, or placed in sealed bags. All vacuums and tools that were used should be wiped using rags wetted with detergent solution. In addition, workers should dispose of the rags.

Consumable/disposable supplies, such as mop heads and rags, should be replaced after each dwelling is completed. Using a contaminated mop head can be a major impediment to achieving clearance. Soiled items should be handled and disposed of in accordance with guidance provided in Chapter 10.



FIGURE 14.8 Vacuuming the floor containment.

Durable equipment, such as power and hand tools, generators, and vehicles, should be cleaned prior to their removal from the site. The cleaning should consist of a thorough vacuuming followed by wet wiping.

B. Cleaning and Removal of Protective Sheeting

Protective sheeting should be cleaned before being removed. This minimizes the generation of airborne dust and/or spillage of dust and debris while the sheeting is being folded up and bagged. Remove large debris as described above in Section IV.C.1. Clean dust and small debris by vacuuming and wet wiping or mopping (see Figure 14.8). Remove upper-level sheeting, such as that on cabinets and counters, first, after it has been cleaned. When removing sheeting, it should be carefully rolled or folded up so that the more-contaminated side is inward. Next, remove sheeting from the floor. All protective sheeting should be folded carefully from the corners/ends to the middle to trap any remaining dust.

Protective sheeting used to isolate work areas from other spaces should remain in place until after the cleaning and removal of other sheeting. These should then be vacuumed, wet-wiped, and removed last.

Removed sheeting should be placed into double 4-mil or single 6-mil plastic bags, or plastic bags with equivalent (or better) performance characteristics, which are sealed and removed from the premises. As with daily cleanings, this removal process usually requires workers to use protective clothing and respiratory protection, especially for high-dust jobs.

C. Vacuuming and Wet Cleaning

After the protective sheeting has been removed, the entire area should be cleaned, using the combination of vacuuming and wet cleaning recommended below. The area to be cleaned is the area that will be subject to the clearance examination, including all rooms, hallways, stairways, elevators, etc. used by workers as passageways to and from the work area, plus areas used to store tools and bagged or packaged debris from the work. (See Section IV.A of Chapter 15 regarding the determination of the clearance area.) Porches, sidewalks, driveways, and other hard exterior surfaces should be vacuumed if exterior hazard control or other paint-disturbing work was conducted, or if debris was stored or dropped on such surfaces.

Interior cleaning for high-dust jobs should begin on the ceilings and end on the floors (following the catch phrase “ceiling to floor and out the door”) For low-dust jobs, it is not necessary to clean ceilings and walls unless paint-disturbing work has been conducted on those surfaces. (See Chapter 8 for a description of low-dust and high-dust jobs.) Cleaning should be sequenced to avoid passing through rooms already cleaned, with the dwellings’ entryway cleaned last.

Surfaces frequently cleaned include ceilings, walls, floors, window panes and mullions, interior window sills, window troughs, exterior window sills, doors, heating, ventilation, and air conditioning (HVAC) equipment (heating diffusers, radiators, pipes, vents), fixtures of any kind (light, bathroom, kitchen), built-in cabinets, and appliances.

Surfaces such as porous concrete, old uncoated, worn and porous hardwood floors, and areas such as corners of rooms and window troughs pose especially difficult cleaning challenges. Porous concrete and corners of rooms normally require additional vacuuming to achieve an acceptable level of cleanliness.

After a high-dust job, the recommended first cleaning step is vacuuming to pick up large amounts of dust and small debris. All surfaces should be vacuumed: ceilings, walls, windows, doors, shelves, floors, etc. Research indicates that walls and ceilings retain leaded-dust after lead hazard control projects (Dixon, 2004). Vacuuming is especially important if some of the surfaces are rough. The second step is a wet cleaning, using the wipe or mopping method, as described above in Section III.D. Wet cleaning is probably the most effective method of picking up small particles of lead-dust (California Dept. of Health Services, 2004). (Be sure to vacuum and wet-wipe window troughs, because they are tested for dust-lead by the clearance examiner.) Vacuuming and wet-cleaning once should be sufficient if the surfaces are smooth, but it is recommended that rough surfaces be vacuumed a second time, after the wet-cleaned surface has dried, to increase the likelihood of achieving clearance. As an alternative to the second vacuum pass, some contractors have found that better clearance results on rough surfaces are achieved by thoroughly wiping by hand the wet-cleaned surface until it is dry, using disposable towels (Rupp, 2003). The amount of wiping needed to clean a surface may depend on how soiled it is, as well as its smoothness or roughness.

After low-dust jobs, the first pass with the vacuum is usually not necessary, especially if the surface is smooth. It is often effective to begin with a wet cleaning. But if there is a substantial amount of dust or small debris on the surfaces to be cleaned, begin with the vacuum and then go to the wet cleaning. This will make the wet cleaning more efficient. Vacuuming following the wet cleaning is recommended for rough surfaces but may not be necessary for smooth surfaces. It is generally not necessary to clean ceilings and walls after low-dust jobs, unless paint disturbing work has been conducted on those surfaces. Remember to clean the window troughs. These recommendations are summarized in Table 14.1.

Table 14.1 Summary Guidance on Cleaning Methods by Dustiness of Work and Condition of the Surface.

Conditions	Cleaning Procedure	Surfaces
High-dust job, with some rough surfaces	Vacuum, wet clean, vacuum (after surface is dry)	All surfaces, including ceilings, walls, and window troughs.
High-dust job, with all smooth surfaces	Vacuum, wet clean	
Low-dust job, with some rough surfaces	Vacuum (optional, depends on amount of dust), wet clean, vacuum (after surface is dry)	All surfaces except ceilings and walls, unless those surfaces have been treated.
Low-dust job, with all smooth surfaces	Vacuum (optional, depends on amount of dust), wet clean	



FIGURE 14.9 Inspecting for completeness of the work performed.

D. Supervisor's Preliminary Visual Inspection

After the cleaning is completed, the supervisor should visually evaluate the entire area subject to clearance (including work areas, worker passageways and storage areas) to ensure that all work has been completed and all visible dust and debris has been removed (see Figure 14.9). The supervisor's preliminary inspection does not replace the independent visual assessment and dust testing conducted by the clearance examiner. If the clearance examiner's visual assessment results are unsatisfactory, dust testing is postponed until identified surfaces are recleaned and/or retreated. This process makes it cost effective to have the supervisor perform a preliminary visual inspection.

E Surface Painting or Sealing of Non-Floor Surfaces

The next step of preparing for clearance (or cleaning verification) is painting or otherwise sealing all treated surfaces except floors. Surfaces, including walls, ceilings, and woodwork, should be coated with an appropriate primer and repainted. Surfaces enclosed with vinyl, aluminum coil stock, and other materials traditionally not painted are exempt from the painting provision.

Painters should use the following lead-safe work practices:

- ◆ Using "drop cloths," which should be disposable, impermeable sheeting – not cloth,
- ◆ Cleaning their work tools before bringing them into the clearance area, and
- ◆ Ensuring no dust is tracked in from outside the clearance area.

F. Sealing Floors

The next step before clearance is to seal all hard-surface floors that do not already have an intact, nonporous coating. Sealed surfaces are easier for residents to clean and maintain over time than those that are not sealed. Wooden floors should be sealed with clear polyurethane or painted with deck enamel or durable paint. Vinyl tile, linoleum, and other similar floors should be sealed with an appropriate floor wax (or equivalent product). Concrete floors should be sealed with a concrete sealer or other type of concrete deck enamel. However, if these floors are already covered by an effective coat of sealant, it may be possible to skip this step.

As an alternative to sealing, floors may be covered with new vinyl tile, sheet vinyl, linoleum flooring, or the equivalent to create a more permanent cleanable surface. New surfaces should be cleaned with a cleaning solution that is appropriate for that type of surface.

Workers applying floor sealants or coverings should take care to wipe clean tools brought into the work area and to avoid tracking in dust from outside the clearance area.

G. Final Wet Cleaning, EPA Cleaning Verification, and Possible Pre-Clearance Dust Testing

Even if painters and floor covering workers use lead-safe work practices, lead-contaminated dust may still migrate into previously cleaned areas. Therefore, it is recommended that the final step before the clearance examination is to wet clean all horizontal surfaces one more time (see Figures 14.10 through 14.13).

HEPA vacuum all surfaces

Start at the end farthest from the main entrance/exit. As you vacuum, move towards the main exit and finish there.



Begin at the top of each room and work down. For example, start with the top shelves, the top of the wood work, and so on, and work down to the floor. Do every inch of the window, especially the window trough.



Courtesy: Alice Hamilton Occupational Health Center

FIGURE 14.10 The HEPA Vacuum-Wet Wash-HEPA Vacuum Cycle Helps Meet Clearance Standards.

Wash all surfaces in the work area with suitable detergents, including areas that had been covered with plastic. Some wallpaper should only be HEPA vacuumed, since it may be damaged by the detergent.



Wipe All Surfaces



Wet Mop Floor



Don't Dry Sweep

FIGURE 14.11 Wet Cycle Requires Washing All Surfaces with Suitable Detergents.

Use the 3-Bucket System

To wash: Use string mops and mop buckets with wringers. (Some experts say NEVER use a sponge mop on the floor. Sponge mops may only push the lead around on the floor, not remove it.)

Dip the string mophead in the detergent wash in bucket #1. Mop the floor.

Squeeze out the mophead in empty bucket #2. Return no bucket #1 for more detergent solutions and continue mopping. Repeat.

Use the third bucket for rinsing the floor.

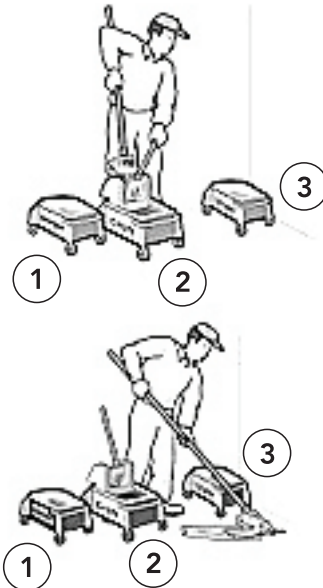


FIGURE 14.12 Use a Three-Bucket System and Then HEPA Vacuum Again to Minimize Recontamination.

HEPA vacuum all surfaces a final time

HEPA vacuum all surfaces in the work area, including areas that had been covered with plastic.

Starting at the far end, work towards the decontamination area. Begin with ceilings or the top of the walls and work down, cleaning the floors last. Do every inch of the windows, especially the troughs. Use the corner tool to clean where the floor meets the baseboard and all the cracks in the floor boards. Use the brush tool for the walls. Move slowly and carefully to get all the dust.



FIGURE 14.13 HEPA vacuum all surfaces a final time.

Under EPA's Renovation, Repair and Painting rule, after the renovation has been completed, the firm must clean the work area until no dust, debris or residue remains (see Appendix 6). The post-renovation cleaning verification requirements must be performed by a certified renovator. If the certified renovator directs the other workers to perform the work practices, the certified renovator must be at the work site during cleaning of the work site. For more information on EPA's RRP rule and the cleaning it requires, see www.epa.gov/lead/pubs/renovation.htm.

At this point in the process, supervisors of work for which achievement of clearance is known to be difficult may wish to consider preliminary dust testing before requesting the clearance examination. Factors that tend to be associated with clearance failure are (1) high levels of lead in dust and paint before the work began, (2) hard floor and window surfaces that are not smooth and cleanable, and (3) high-dust work in rooms from which furniture has not been removed (NCHH, 2004).

Methods exist for reliably screening wipe samples on-site instead of in a fixed laboratory. These include portable X-ray fluorescence (XRF) analysis and anodic stripping voltammetry (ASV) (Ashley 2001; EPA, 2002b; Clark, 2002) or potentiometric stripping analysis (PSA). These methods may provide testing results much more quickly than fixed laboratory analysis, because transportation of samples is not necessary and handling time is reduced. Note that analysis of samples taken from target housing of pre-1978 child-occupied facilities must be conducted by a laboratory, whether fixed-site or mobile, recognized by the Environmental Protection Agency (EPA) under its National Lead Laboratory Accreditation Program (NLLAP) (<http://www.epa.gov/lead/pubs/nllap.htm>).

Any person who is trained and otherwise qualified to operate the XRF instrument or use the ASV method may use these methods to conduct *preliminary* dust testing to determine whether the clearance area is clean and ready for the clearance examination. A person conducting a preliminary screen does not have to be a technician working for an NLLAP-recognized laboratory; the sample may be collected by the contractor or the owner, and given to the laboratory for analysis. Owners and contractors may wish to use such screening tests to minimize the likelihood of clearance failure. Federal and State regulations on the use of devices with radioactive elements (i.e., some XRF analyzers) must be observed (see Chapter 7, section VII.A).

H. Clearance

The clearance examination should take place more than 1 hour after the final cleaning. This ensures that any airborne lead particles stirred up by the cleaning have settled. Clearance is usually performed after the sealant is applied to the floor. See Chapter 15 for information on clearance examination procedures. For cleaning verification, a waiting period is not required for the initial wipe, nor after the first failed wipe, but a 1-hour waiting period is required after the second failed wipe before the work area is released from the project.

I. Recleaning After Clearance Failure

If the area fails the clearance examiner's visual assessment or clearance dust sampling tests, all surfaces represented by the failing clearance dust wipe samples must be recleaned. Failure is an indication that the cleaning has not been successful. If the surfaces are smooth, a wet wash should be used. If the surfaces are rough, a vacuum, wet-cleaning, vacuum cycle is recommended. If the failing surfaces include carpeting, the decision must be made whether to try to clean the carpet or to dispose of it. See Section V.B.2 of Chapter 11 for guidance. Care should be exercised during the recleaning of "failed" surfaces or components to avoid recontaminating "cleared" surfaces or components.

References

Ashley, 2001. Ashley, K., Wise, T.J., Mercado, W., Parry D.B., Ultrasonic extraction and field-portable anodic stripping voltammetric measurement of lead in dust wipe sample. *Journal of Hazardous Materials*, 83: 41-50, 2001.

California Department of Health Services, 2004. Public Health Institute for California Department of Health Services, Childhood Lead Poisoning Prevention Branch and Environmental Health Laboratory Branch, "Evaluation of Household Vacuum Cleaners in the Removal of Settled Lead Dust from Hard Surface Floors," Final Report to U.S. Department of Housing and Urban Development, 2004.

CMHC, 1992. Canada Mortgage and Housing Corporation, Saskatchewan Research Council Report, *Effectiveness of Cleanup Techniques for Leaded Paint Dust*, Saskatoon, Saskatchewan, Canada (also see Figley, 1994). (<http://www.cmhc-schl.gc.ca/publications/en/rh-pr/tech/92-203.pdf>)

Clark, 2002. Clark, C.S., "Development of a Rapid On-Site Method for the Analysis of Dust Wipes Using Field Portable X-Ray Fluorescence," prepared for the U.S. Department of Housing and Urban Development, January, 2002.

Dixon, 2004. Sherry Dixon, Jonathan Wilson, Paul Succop, Mei Chen, Warren Galke, William Menrath, and C. Clark, "Residential Dust Lead Loading Immediately After Intervention in the HUD Lead Hazard Control Grant Program," *Journal of Occupational and Environmental Hygiene*, 1: 716 – 724.

EPA, 1997a. U.S. Environmental Protection Agency, *Laboratory Study of Lead-Cleaning Efficacy*, March 1997 (EPA 747-R-97-002).

EPA, 1998. U.S. Environmental Protection Agency, *Lead-Cleaning Efficacy Follow-Up Study*, October 1998 (EPA 747-R-98-008).

EPA, 2002b. U.S. Environmental Protection Agency, The Environmental Technology Verification Program (ETV), Verification Statements EPA-VS-SCM-50, 51, 52, 53 and 54. Prepared by Oak Ridge National Laboratory, Oak Ridge, Tennessee, August, 2002.

Ewers, 1994. Ewers, L., S. Clark, W. Menrath, P. Succop, and R. Bornschein, "Clean-Up of Lead in Household Carpet and Floor Dust," *Journal of the American Industrial Hygiene Association*, 55(7):650-7, July, 1994.

Lewis, 2006. Roger D. Lewis, Sridhar Condoor, Joe Batek, Kee Hean Ong, Denis Backer, David Sterling, Jeff Siria, John J. Chen, and Peter Ashley, "Removal of Lead Contaminated Dusts from Hard Surfaces," *Environ. Sci. Technol.*, 40, 590 -594, 2006. <http://pubs.acs.org/doi/abs/10.1021/es050803s>.

Lewis, 2012. Lewis R.D., Ong, K.H., Emo, B, Kennedy, J., Brown, C.A., Condoor, S. and Thummalakunta, L. Do New Wipe Materials Outperform Traditional Lead Dust Cleaning Methods? *Journal of Occupational and Environmental Hygiene*, 9:8 524-533, August 2012. <http://www.tandfonline.com/doi/abs/10.1080/15459624.2012.695975>

NCHH, 2004. National Center for Healthy Housing, and University of Cincinnati Department of Environmental Health, *Evaluation of the HUD Lead-Based Paint Hazard Control Grant Program: Final Report*, prepared for the U.S. Department of Housing and Urban Development, Washington, DC, May 1, 2004.

Rich, 2002. Rich, David Q., G.G. Rhoads, L. Yiin, J. Zhang, Z. Bai, J.L. Adgate, P.J. Ashley and P.L. Liroy, "Comparison of Home Lead Dust Reduction Techniques on Hard Surfaces: The New Jersey Assessment of Cleaning Techniques Trial," *Environmental Health Perspectives*, 110(9): 889-893, September, 2002.

Rupp, 2003. Rupp, R. and R. Zatzke, "Comments on Proposed Revisions to Chapter 14 of the HUD *Guidelines*, Unpublished memorandum, May 8, 2003.

White, 2003. White, K. and G. Dewalt, Unpublished comments on proposed revisions to Chapter 14 of the HUD *Guidelines*, May 2003.

Yiin, 2002. Yiin, Lih-Ming, F.F. Rhoads, D.Q. Rich, J. Zhang, Z. Bai, J.L. Adgate, P.J. Ashley and P.J. Liroy, "Comparison of Techniques to Reduce Residential Lead Dust on Carpet and Upholstery: The New Jersey Assessment of Cleaning Techniques Trial," *Environmental Health Perspectives*, 110(12): 1-5, December, 2002.

Chapter 15: Clearance

HOW TO DO IT	15-4
I. Introduction.....	15-7
A. Regulations Pertaining to Clearance.....	15-7
B. Purpose and Scope of Clearance.....	15-7
C. De Minimis Area – Minimal Area of Paint Disturbance when Clearance Is Not Required.....	15-9
II. Qualifications for Clearance Examiners.....	15-10
A. Regulatory Qualifications.....	15-10
B. Conflicts of Interest	15-10
III. Time Between Completion of Cleanup and Clearance	15-11
IV. The Clearance Area, and Sampling of Units, Rooms, or Areas	15-12
A. Determining the Clearance Area and Schedule	15-12
1. Interior Clearance Areas	15-12
2. Clearance Area Following Exterior Work.....	15-13
3. Information for Clearance Area Determination.....	15-14
B. Sampling of Rooms, Units or Areas.....	15-15
1. Sampling Rooms within a Unit.....	15-15
2. Sampling Units within a Multi-family Property	15-16
V. Visual Assessment.....	15-17
A. Visual Assessment for Deteriorated Paint	15-17
B. Visual Assessment for Settled Dust and Debris	15-19
1. Interior	15-19
2. Exterior	15-20
C. Completion of the Visual Assessment Form.....	15-20
VI. Clearance Dust Sampling	15-20
A. Sampling Methods.....	15-20
1. Wipe Sampling	15-20
2. Composite Sampling	15-21
3. On-site Dust Testing	15-24
B. Clearance Dust Sampling and Sealant Application	15-25
C. Location and Number of Clearance Dust Samples.....	15-25
1. Clearance Categories	15-25
2. Selection of Rooms.....	15-29
3. Selection of Locations Within Rooms.....	15-30
4. Sampling Outside the Containment Area	15-32
5. Worksite-Only Sampling	15-32

6. Composite Sampling: An Example.....	15-33
D. Securing the Clearance Area	15-33
VII. Clearance Soil Sampling (optional).....	15-34
A. Considerations for Sampling Soil Before the Work	15-34
B. Considerations for Sampling Soil After the Work	15-34
C. Multi-family Housing Properties with more than One Building	15-35
VIII. Determining Specified Hazard Control Work was Done (optional)	15-36
A. Paint Removal and Repainting.....	15-37
B. Building Component Removal and Replacement.....	15-38
C. Enclosures	15-38
D. Encapsulants	15-38
E. Soil Treatments	15-38
F. Interim Controls.....	15-38
IX. Interpretation of Clearance Results, Recleaning, and Resampling	15-39
A. Visual Assessment Results.....	15-39
B. Dust Sampling Results.....	15-39
C. Recleaning and Resampling	15-39
1. Single-Surface Clearance Sampling.....	15-39
2. Composite Clearance Sampling	15-40
X. Report Preparation	15-42
A. Summary Report	15-42
B. Regulatory Report Requirements.....	15-43
XI. Recordkeeping	15-44
A. Recordkeeping Responsibilities.....	15-44
B. Record Content.....	15-44
C. Length of Retention	15-44
REFERENCES.....	15-55
FORMS	
Form 15.1 Visual Assessment – Lead Hazard Clearance Examination.....	15-45
Form 15.2 Field Sampling Form for Dust – Lead Hazard Clearance Examination (single-surface sampling).....	15-46
Form 15.3 Lead Hazard Clearance Report – Completed Example	15-47
Form 15.4 Clearance Report Review Worksheet.....	15-53
Form 15.5 Clearance Report Review Worksheet – Completed Example.....	15-54

TABLES

Table 15.1	Minimum Number and Location of Dust Samples	15–27
Table 15.2	Clearance Dust Standards (Single-Surface Wipe Samples).....	15–39
Table 15.3	Clearance Dust Standards (Composite Wipe Samples)	15–41
Table 15.4	Hypothetical Example of Single-Surface Clearance Dust Sampling Data.....	15–41
Table 15.5	Hypothetical Example of Composite Clearance Dust Sampling Data.	15–41

FIGURES

Figure 15.1	Windows sealed to prevent dust migration	15–13
Figure 15.2	Visible paint chips and debris in soil	15–14
Figure 15.3	Visible dust Indicates recleaning is needed	15–19
Figure 15.4	Tracking of dust that may contain lead	15–19
Figure 15.5	Indications that children are present.....	15–26
Figure 15.6	A floor that may be tested	15–30
Figure 15.7	A windowsill and trough that may be tested	15–30
Figure 15.8	Window locations for dust sampling	15–31
Figure 15.9	Soil debris.....	15–34
Figure 15.10	Surfaces that may have been paint stripped.....	15–37

Chapter 15: Clearance

How To Do It

- 1. Qualifications for clearance examiners.** The owner, funding agency, certified abatement contractor, or certified renovation contractor should select the clearance examiner, preferably before lead-based paint hazard control work begins.
 - ◆ Clearance on all projects involving abatement (as defined by EPA) must be done by a certified risk assessor or a certified lead-based paint inspector. Check with EPA regarding qualifications for clearance of non-abatement activities.
 - ◆ For properties covered by HUD's Lead Safe Housing Rule, and those of some State regulations, clearance of non-abatement work may be performed by a certified risk assessor or lead-based paint inspector, or by a certified sampling technician, if the sampling technician is working in single family units or a multi-family dwelling unit and the associated common areas. If the clearance requires development of a random sampling plan, a certified inspector or risk assessor must develop the plan and supervise the sampling technician in its use. Not all States or localities have certified sampling technicians, and some require that non-abatement clearance be conducted only by certified risk assessors or inspectors.
 - ◆ For clearing projects covered by the EPA's Renovation, Repair, and Painting (RRP) rule, a certified risk assessor, certified lead-based paint inspector, or certified dust sampling technician can perform clearance. (See below regarding clearing multi-family housing projects.)
 - ◆ To eliminate conflicts of interest, these *Guidelines* recommend the use of a clearance examiner who is completely independent of the contractor who performs the work. HUD's Lead Safe Housing Rule requires such independence for clearance of most work in HUD-assisted target housing. (See Appendix 6 for details.)
- 2. Determine the clearance area.** Obtain information from the client regarding the nature and location of the work and the dust containment (if any); for an abatement, project, validate or obtain a copy of the abatement site plan. Then determine the clearance area (i.e., the dwelling units, common areas, rooms, and/or exterior areas that are subject to the clearance examination). Clearance examiner should explain all aspects of the examination to the client.
- 3. Preclearance worksite inspection on behalf of the client (optional):** As part of deciding, once the lead hazard control, renovation or maintenance work has been completed, the cleanup is done, and the floors are sealed (if necessary), whether to call for the clearance examiner, the client, contractor or maintenance supervisor may conduct a visual assessment of the clearance area to determine if there is any deteriorated paint, visible settled dust, paint chips, or paint-related debris in the interior or around the exterior of the building(s). If conducted, this preliminary visual assessment should be conducted in all the dwelling units and rooms in the clearance area, except that it may be conducted in a sample of dwelling units and related common areas in a multi-family property. After the visual assessment is passed, it may also be useful to take dust samples for quick onsite analysis before calling the clearance examiner.
- 4. Wait one hour for dust to settle.** Before beginning the clearance examination, wait at least 1 hour after the hazard control, renovation, or maintenance work is finished, the cleanup is done, and the floors are sealed (if necessary) to allow any leaded-dust particles to settle. Do not enter the work area during that period.

5. **Conduct visual assessment.** Conduct a visual assessment (called a visual inspection by EPA) of the clearance area to determine if there is any deteriorated paint, visible settled dust, paint chips, or paint-related debris in the interior or around the exterior of the building(s). The visual assessment should be conducted in all the dwelling units and rooms in the clearance area, except that it may be conducted in a sample of dwelling units and related common areas in a multi-family property (see chapter 7 for unit/common area sampling methods).
6. **Complete visual assessment form.** Complete a visual assessment form for clearance, such as Form 15.1 in this chapter. If any unexplained deteriorated paint or visible dust, paint chips, or paint-related debris are found, inform the client and request that hazard controls and/or cleanup be completed, as necessary, so that dust sampling can proceed. See 24 CFR 35.1340(c) for more details of what is required under the Lead Safe Housing Rule for HUD-assisted housing (see Appendix 6).
7. **Conduct dust sampling.** After the clearance area has passed visual assessment, conduct clearance dust-wipe sampling of floors, interior window sills, and window troughs using the protocol in this chapter and Appendix 13.1, or ASTM Standard E 1728 (www.astm.org/Standard/index.shtml).
8. **Complete a dust sampling form** for clearance, such as Form 15.2 in this chapter.
9. **Submit dust samples for analysis** for lead to a laboratory recognized for analysis of lead in dust by the EPA's National Lead Laboratory Accreditation Program (NLLAP).
10. **Interpret the laboratory results** by comparing them to the applicable standards. In most jurisdictions, these will be the EPA clearance standards described in this chapter. If State or local standards differ from the EPA standards and the work being cleared is subject to HUD or EPA lead-based paint regulations, the most protective standards (EPA, State, or local) apply. If the work being cleared is not subject to HUD or EPA regulations, use State or local standards, if they exist. If State or local standards do not exist, use the EPA standards.
11. **Notify the client of the results of laboratory tests** as soon as they are received, so residents can reoccupy the clearance area as soon as possible if clearance is achieved, or recleaning can be started quickly if dust-lead levels exceed applicable standards.
12. **If clearance is achieved**, go to step 15. If not, go to follow steps 13 and 14.
13. **Repeat cleaning if clearance is not achieved.** If dust-lead levels are equal to or greater than the applicable standards, the client should order repeated cleaning. Clean all surfaces that the failing samples represent. Keep the clearance area secure until clearance is achieved.
14. **Continue sampling and repeat cleaning until the clearance area achieves compliance with applicable clearance standards.** Failure to achieve clearance is usually caused by inadequate cleaning and/or results when surfaces have not been made smooth and cleanable. Sometimes additional hazard control work is necessary.
15. **Complete related construction and final clearance.** After clearance has been achieved, any related construction work that does not disturb a surface with lead-based paint (all work that does disturb painted surfaces or that could generate leaded dust should be completed as part of the lead hazard control effort). If any additional paint-disturbing work is to be done in the clearance area, there should be another final clearance examination after such work to assure that the space is safe for occupancy. (See Section VII.C of Chapter 8.)

16. **Prepare report.** Prepare and deliver to the client a report of the clearance examination. You may use a format such as Form 15.3 in this chapter that includes all the information required in 24 CFR 35.1340(c) for reports on projects other than abatement, and in 40 CFR 745.227(e)(10) for reports on abatement projects. You may use the Clearance Report Review Worksheet (Form 15.4) to ensure that all the required information is included in the clearance report. See also the example of a filled-out Worksheet in Form 15.5.
17. **Compliance with disclosure and notification regulations.** The owner must disclose the scope and results of lead hazard control work, including clearance examination results, to lessees (tenants) and purchasers of the property under Federal law before they become obligated under a lease or sales contract. Also, if the housing is receiving Federal assistance, current residents must be notified within 15 days of receipt by the owner, of the scope and results of lead hazard control work, including the results of clearance examinations, in accordance with the HUD Lead Safe Housing Rule. See Appendix 6 for additional information.

I. Introduction

Clearance refers generally to combined visual and quantitative environmental evaluation procedures used to determine that no lead-based paint hazards remain in the area being cleared after lead hazard controls or paint-disturbing renovation or maintenance have been done. The specific procedures used depend on exactly what the client wants to know and what regulations and standards apply.

A. Regulations Pertaining to Clearance

The U.S. Environmental Protection Agency (EPA) issued regulations and standards at 40 CFR 745.227(e) that apply to clearance whenever abatement of lead-based paint hazards is conducted in most pre-1978 housing nationwide. These regulations apply to all abatements (i.e., measures intended to permanently eliminate lead-based paint hazards). They require that the area being cleared be free of deteriorated lead-based paint and visible dust, debris, paint chips and other residue from the work, and that lead in settled dust be below specified standards.

The U.S. Department of Housing and Urban Development (HUD) issued the Lead Safe Housing Rule, which addresses clearance at 24 CFR 35.1340(b). The regulation applies to clearance after paint stabilization, interim controls, standard treatments, rehabilitation, or ongoing lead-based paint maintenance. HUD's standards and procedures for clearance are the same as those for EPA-regulated abatement, although there are some differences in the qualifications for clearance examiners. The clearance procedures and standards described in this chapter conform to EPA and HUD regulations.

In renovations where the contract between the renovation firm and the property owner or another Federal, State, Territorial, Tribal, or local regulation requires dust clearance sampling by a certified sampling professional, EPA's Renovation, Repair and Painting (RRP) Rule allows for optional dust clearance testing in lieu of the "cleaning verification" procedure.

In projects covered by the EPA's RRP Rule for which clearance is not required, EPA's cleaning verification process is required. (See the description in Appendix 6.)

Some States, Indian Tribes and local governments have issued standards for clearance that may differ somewhat from the Federal requirements. In general, the most protective standards (EPA, State, or local) apply. If the EPA has authorized the State or Tribe's lead certification program, its clearance standards apply rather than the EPA's. If a local clearance standard exists and is more stringent than the State standard, use the local standard. If the work being cleared is not subject to HUD or EPA regulations, use State or local standards, if they exist. If no State or local standards exist, use the EPA standards.

If the applicable (EPA, State or local) clearance standards for lead in dust are not met, EPA and HUD require that cleaning be repeated and additional visual assessments dust testing performed until the area meets clearance standards. If dust-lead levels determined by a clearance examination remain above the clearance standards, the work is not complete; levels of lead in dust must be within clearance standards for the work to be complete.

B. Purpose and Scope of Clearance

The primary purpose of the standard EPA-HUD clearance examination is to determine whether the clearance area is safe for occupancy or for entry by unprotected workers. The clearance report must include, among other elements described in Section X.B, below, information about the lead

hazard control work, which may only be available from the owner or the contractor. You may use the Clearance Report Review Worksheet to insure that the clearance report is complete (See Form 15.4).

If exterior work was performed, the clearance examiner determines, by a visual assessment, if the ground near the work is free of debris, and, through soil-lead sampling and analysis by a laboratory recognized by NLLAP for analysis of lead in soil, if the concentration of lead in nearby soil is below the applicable soil-lead standards. Guidance on optional purposes of clearance examinations is provided in this chapter.

In this chapter, the work that generates the need for a clearance examination is referred to as “the work,” regardless of whether it is abatement or interim controls of lead-based paint or lead-based paint hazards, rehabilitation, renovation, remodeling, or maintenance.

The standard Federal clearance examination has four main phases:

1. A visual assessment of: (a) interior clearance areas to identify any deteriorated paint that may be lead-based and visible dust and debris and (b) exterior areas, if exterior work was performed, to identify any deteriorated paint that may be lead-based and paint chips or other debris near the work surfaces;
2. The collection and analysis of dust samples from interior spaces by wipe sampling;
3. Interpretation of dust sampling results, and follow-up dust testing if the initial results failed to meet applicable standards and additional cleaning is necessary; and
4. Preparation and signing of the clearance report.

Interior clearance may not be necessary if the work was only on the outside and building openings (windows, doors, and vents) were tightly closed or sealed during the work. Airborne dust sampling is not recommended for clearance purposes in lead hazard control work because the results vary due to air flow, particle size, and available dust. In addition, most children are *not* lead-poisoned by inhalation (ATSDR, 1988)

Interior and exterior areas being cleared should be free of deteriorated paint that is or may be lead-based because deteriorated lead-based paint has been determined to be a lead-based paint hazard. Clinical cases of childhood lead poisoning (i.e., cases with relatively high levels of lead in the blood) often result from ingestion of leaded paint chips. If testing has shown that deteriorated paint is not lead-based, the deteriorated paint need not be repaired for the purpose of passing clearance. Interior areas being cleared should also be free of visible dust, loose paint chips and paint-related debris, and exterior areas should be free of paint chips and paint-related debris. Repair of deteriorated paint and cleanup of interior dust, paint chips, and paint-related debris must occur before dust samples are taken because the repair of the paint and cleaning of dust and debris may contaminate the area.

The collection and analysis of dust samples is a critical part of the interior clearance examination. Lead in settled house dust is the most common source of childhood lead exposure. A visual examination alone is not adequate for determining if the interior of a residence is safe for occupancy, because small dust particles are not visible to the naked eye (NCHH, 2002). Lead hazard control work and rehabilitation, renovation, remodeling, and maintenance often generate a considerable amount of leaded-dust. Studies have indicated that cleaning of leaded-dust can be

accomplished only with care and skill (HUD, 1991; NCHH, 2004). Therefore, HUD requires clearance dust sampling to determine if the work area has been cleaned adequately to meet the EPA dust clearance standard(s).

The report of the clearance examination documents the findings. The clearance examination protects *all* parties involved – the job contractor or other workers, the owner, insurance companies, and the residents. Clearance provides the contractor and the owner with an objective determination that the job site was left free of lead-based paint hazards. Clearance assures that children will be safe from lead hazards in the area being cleared as long as the work remains intact and there are not exterior sources contaminating the area. To keep the property lead-safe, the owner should follow lead-safe maintenance practices if it is known or suspected that lead-based paint remains on the property (see Chapter 6). Also, it is recommended that pre-1960 multi-family rental properties be reevaluated by a risk assessor at 2-year intervals following initial interim controls (see Chapter 5, Section VII), and may be required for housing receiving federal assistance covered HUD Lead Safe Housing Rule (see Appendix 6 for details).

A voluntary consensus standard, ASTM E2271, Standard Practice for Clearance Examinations Following Lead Hazard Reduction Activities in Dwellings, and in Other Child Occupied Facilities, may also be used for determining whether a clearance area passes or fails a clearance examination. (<http://www.astm.org/Standards/E2271.htm>) (The version of the standard as of the publication of these *Guidelines* is ASTM E2271 – 05a(2012)e1; the ASTM website should be checked to see if a subsequent edition or standard is current at the time the ASTM standard is being considered for use as part of the clearance process for a job.)

C. De Minimis Area – Minimal Area of Paint Disturbance when Clearance Is Not Required

HUD regulations do not require clearance if the total amount of paint disturbed by non-abatement work is no more than a small or minimal amount. This amount is called a *de minimis* area or *de minimis* amount. Specifically, the *de minimis* areas are areas up to:

- (1) 20 square feet on exterior surfaces,
- (2) 2 square feet in any one interior room or space, or
- (3) 10 percent of the total surface area on an interior or exterior type of component with a small surface area (such as windowsills, baseboards, and trim).

Note that the HUD *de minimis* thresholds are different from the EPA's *minor repair and maintenance activities* thresholds (40 CFR 745.83) under its RRP Rule for work that that disrupts:

- (1) 6 square feet or less of painted surface per room for interior activities; or
- (2) 20 square feet or less of painted surface for exterior activities;

provided that none of the work practices prohibited or restricted by 40 CFR 745.85(a)(3) were used and where the work does not involve window replacement or demolition of painted surface areas (see Appendix 6 for details).

II. Qualifications for Clearance Examiners

A. Regulatory Qualifications

Clearance examinations are regulated by EPA and HUD, as well as by States and Tribes with EPA-authorized lead certification programs for inspection, risk assessment, or dust sampling technicians.

EPA regulations recognize two disciplines as being qualified to perform clearance examinations following abatement of lead-based paint hazards: certified risk assessors, and certified lead-based paint inspectors. Some EPA-authorized States and Tribes, however, permit only certified risk assessors to perform clearance examinations.

In addition to risk assessors and lead-based paint inspectors, HUD regulations (at 24 CFR 35.1340(b)(1)) and EPA Renovation, Repair, and Painting (RRP) regulations (at 40 CFR 745.90(a)(1)) recognize a third category, certified dust sampling technicians (originally called “clearance technicians”). These technicians are qualified to perform many non-abatement clearances, because their training does not cover random sampling, they may not conduct non-abatement clearances of multi-family properties in which clearance involves random sampling of dwelling units except under the circumstances and supervision described in the following paragraph. EPA does not allow dust clearance testing in lieu of post-renovation cleaning verification, except in limited circumstances. EPA recommends that any property owners who choose to have dust clearance testing performed after a renovation use a certified inspector, risk assessor, or dust sampling technician.

HUD regulations permit certified sampling technicians to perform clearances after non-abatement work if the clearance examination is approved and the report is signed by a certified risk assessor or lead-based paint inspector. Because sampling technicians do not have the training to randomly select dwelling units, common areas and/or exterior areas for sampling in multi-family properties, for multi-family properties where units are to be randomly selected under either the HUD regulations or the EPA’s RRP Rule, the certified risk assessor or lead-based paint inspector must perform the random selection and instruct the sampling technician to conduct clearance work where selected. Also, sampling technicians do not have the training to determine that specified hazard control work has been completed (see Section VIII, below, for an explanation of this optional activity).

B. Conflicts of Interest

For clearance to achieve its purpose there must be integrity in the process, in appearance as well as in fact. People performing hazard control, rehabilitation, or maintenance work and the cleanup following such work must not know where clearance dust samples will be taken. To achieve this goal, clearance examiners should be as independent as possible of those performing the work. The clearance examiner’s only concern should be that compliance with clearance standards has been achieved.

It is best practice for the owner (or the agency administering public assistance funding the work) to retain the clearance examiner, rather than having the contractor who performs the work do so. In addition, the clearance examiner should not be paid, employed, or otherwise compensated by the hazard-control or renovation contractor. The independence of the clearance examiner is generally required in projects covered by HUD’s Lead Safe Housing Rule (24 CFR 35.1340(f)). It should be noted that, under EPA regulations pertaining to abatement and renovation, an abatement or renovation contractor may select and pay the clearance examiner.

Some owners of multiple dwelling units may wish to have work performed by their own trained crews, rather than contract for such services. In this case it is best practice that clearance be performed by an independent third party whose payment is not dependent on completion of the job within any particular time period. HUD regulations do permit property owners to use clearance examiners in their employ, however, provided the same in-house employees do not conduct both the work and its clearance examination. Ultimately, it is the professional integrity of those performing clearance that will determine whether the process succeeds. To minimize any perceived conflict of interest it is strongly recommended that the clearance examiner be completely independent from the person performing the lead-hazard control treatments (see above regarding HUD's Lead Safe Housing Rule).

This does not mean that job supervisors should not perform their own visual assessments of the quality of the cleaning job performed by their workers as a "pre-clearance" step. Owners, contractors, or public agencies may also find it useful to take their own pre-clearance dust samples for quick onsite analysis (using, for example, portable XRF, anodic stripping voltammetry (ASV), or potentiometric stripping analysis (PSA) technology) before calling in the clearance examiner. If the pre-clearance determination is that the area is not ready for the clearance examiner, the supervisor must order the work area to be recleaned. Such pre-clearance assessments and follow-up will make it more likely that clearance standards are met the first time around (see Section VI.A.3, below).

The clearance procedures contained in this chapter should always be included in the job specifications so that performance responsibilities are clear.

III. Time Between Completion of Cleanup and Clearance

Clearance dust sampling should be performed no sooner than one hour after completion of the final cleanup to permit airborne leaded-dust to settle. Clearance dust sampling is for *settled* leaded-dust, not airborne leaded dust, because the main source of lead exposure for children is through contact with contaminated surfaces followed by ingestion through hand-to-mouth contact. While often performed for asbestos abatement projects, air sampling does not appear to be a useful tool for determining if clearance has been achieved in lead hazard control work. Because asbestos fibers are known to have low settling velocities (that is, they take a long time to settle out of the air), air sampling can be used to determine the effectiveness of the cleanup effort in asbestos abatement jobs. But because dust particles typically generated during lead hazard control jobs are larger, denser, more spherical, and heavier, settling time is much faster. A one-hour waiting time is recommended because the additional amount of leaded-dust that would settle onto floors after one hour has been empirically found to be much less than the clearance standard for floors ($40 \mu\text{g}/\text{ft}^2$) or window sills ($250 \mu\text{g}/\text{ft}^2$) (Choe, 2000).

Entry into the area should be prohibited, and openings from the clearance area should remain closed during the waiting period to keep turbulence and resuspension of particulate matter to a minimum, as well as minimize any potential for cross contamination or unauthorized entry.

IV. The Clearance Area, and Sampling of Units, Rooms, or Areas

A. Determining the Clearance Area and Schedule

A matter of critical importance in the design of a clearance examination is determining the area that must be examined (the clearance area). Clearance examiners should reach an understanding on this with their clients as early as possible. Misunderstanding can lead to costly disputes and delays. Clearance examiners must know in advance the scope of the clearance examination (e.g., the rooms, dwelling units, common areas and/or exterior areas to be cleared) in order to make sound sampling plans and reliable fee estimates. Contractors or other persons performing the work and the associated cleaning must understand in advance the clearance examination process (i.e., visual assessment followed by dust testing), but they must not be informed about the specific sampling locations, in order to avoid their biasing their cleanup activities, even if unintentionally.

Clients should be informed that dust samples will be taken on window troughs, as well as window sills and floors, as part of the clearance examination after interior work has been done. Otherwise contractors or maintenance staff may neglect to clean window troughs (see Section VI.C.3 and Figure 15.2, below, for a definition and illustration of window troughs).

It is also suggested that the clearance examiner discuss with the client any job-specific factors that may affect the schedule for the examination and the speed with which laboratory results are needed. Possible factors include the need for reoccupancy of the clearance area or for contractors to do additional work (see Section VI.E, below, for a discussion of laboratory turnaround).

1. Interior Clearance Areas

For clearance following interior work, these *Guidelines* define the following three clearance categories, each with a different clearance area (see Section VI.C.1 and Table 15.1, below):

Category 1. No containment of dust in the rooms or common areas in which work is conducted. Because other rooms or common areas where no work was done may be contaminated, clearance must cover/represent the entire space (e.g., work area and all the rooms in the dwelling unit and/or the common areas that are associated with the work area).

Category 2. Dust has been contained to the work area. Clearance covers at least the area within the containment, plus the floor outside the containment area (to make sure contamination has not spread), plus passageways used by workers walking to and from the work area. (Alternatively, clearance Category 1 may be used.) To determine a Category 2 clearance area, the clearance examiner must know exactly where the containment was located and what passageways were used by workers.

Category 3. "Worksite only" clearance. This category of clearance is acceptable following a small amount of contained interior work not intended to be abatement that takes a short time to complete. In these cases, the clearance area may be limited to the rooms in which work has been done. (Alternatively, clearance Categories 1 or 2 may be used.)

The critical factors in determining the clearance area are: (1) the location of the work (i.e., what rooms, if interior, and what surfaces, if exterior); (2) the type and location of dust containment during the work; (3) whether the work was a low-dust or high-dust job; and (4) the duration of the job. The best way to obtain information on these factors is to observe the work in progress.

If the clearance examiner cannot observe the work in progress, he or she should request the information from the client and should determine the clearance area based on the information received. Record the information that forms the basis for the clearance area determination and include it in the final report (see Section IV.A.3, below).

Dust containment. EPA regulations on clearance following abatement (at 40 CFR 745.227(e)(8)) make the clearance area dependent on dust containment. Similarly, HUD regulations on clearance following activities other than abatement (at 24 CFR 35.1340(b)(2)) incorporate the clearance steps set forth in the EPA abatement regulation. For projects covered by the EPA's RRP Rule but not HUD's Lead Safe Housing Rule or a State or local regulation, if clearance is performed after the work as an alternative to cleaning verification, the clearance must be of at least the work area.

For interior work that may create high dust levels, containment generally includes such steps as: temporarily turning off heating, ventilating, and air-conditioning (HVAC) systems; sealing vents; and installing primitive airlocks with protective sheeting over doors to rooms in which work is being done; and covering the floors of work areas and passageways used by workers with disposable, impermeable protective sheeting. The use of primitive airlocks over work-area doors and the temporary elimination of HVAC airflow are the key methods for containing dust spread to the work area. (See Chapter 8 for a detailed discussion of containment methods as a part of worksite preparation.)

For interior work that will not create high dust levels, containment may be as little as laying protective sheeting on the floor where the surfaces will be disturbed.

Although clearance of rooms and spaces outside the containment area may not be required (except for the floor just outside the containment), complete clearance of all rooms in a dwelling unit and/or other associated spaces provides assurance that all living areas are free of lead-based paint hazards. Therefore, owners and lead hazard control contractors should carefully consider the benefits of cleaning and clearing areas outside the containment relative to the additional cost, which is often marginal.



FIGURE 15.1 Windows sealed to prevent migration of dust outside.

2. Clearance Area Following Exterior Work

Category 4. Exterior areas must be cleared following work that has disturbed or may have disturbed exterior lead-based paint. Interior clearance is not necessary following exterior work if the only work being done is on the outside and if there is dust containment due to a tightly closed opening between exterior and interior spaces (e.g. window and/or door). In this type of containment, windows, doors, vents, and other building openings near the work area are sealed or tightly closed to prevent migration of dust from the outside to the inside during the work (see Figure 15.1). If building openings near the work area are not sealed or tightly closed, clearance must be conducted in interior spaces that may have been affected. Exterior clearance is not explicitly required by EPA and HUD regulations if the only work being done is on the inside of the building. However, in such cases, exterior contamination could occur if material is thrown out of windows or unwrapped waste is laid on the ground. Therefore the clearance examiner should perform a visual assessment of the grounds near the building(s) and ask the client to remove any paint chips and other paint-related debris that are found.

Exterior clearance following exterior paint work consists of a visual assessment for visible surface dust, debris and residue, only. It is not necessary to sample soil or exterior dust unless the owner or contractor wishes to have additional assurance of no remaining hazards (see Section VII, below). The visual assessment should cover exterior painted surfaces (to identify deteriorated paint) and ground areas, vegetation and horizontal building surfaces (e.g., exterior window sills, porch floors and railings) on which dust and debris may have fallen as a result of the work. If a child under age 6 uses a porch, balcony, deck, or similar space as a play area, inspect the space thoroughly if it is near the surfaces on which work was done to make sure it is free of visible dust and debris (see Figure 15.2). In deciding the area of the exterior visual assessment, the clearance examiner should take into account the nature, extent, location, and duration of the work and the design of the containment used to limit the spread of dust and paint chips. Generally, 10 to 20 feet is an adequate distance out from the sides of the building where work was done, depending on the characteristics of work.



FIGURE 15.2 Visible paint chips and debris in the soil.

Under the standard HUD-EPA clearance procedure, the clearance examiner is not required to determine whether abatement or interim controls of soil-lead hazards have been performed satisfactorily and as specified. Therefore it is not necessary to conduct a visual assessment to identify bare soil that may have been untreated or to take soil samples. However, soil samples may be collected as an option (see Section VII, below).

3. Information for Clearance Area Determination

The clearance examiner should record information about the nature of the work in writing, whether in a narrative, a list, or on a floor plan.

- ◆ Record the source of the information (e.g., the client, the contractor, or from direct on-site observation of the work in progress).
- ◆ Record the clearance area agreed to with the client. If the agreed-upon clearance area differs from the clearance examiner's recommendation, include a written explanation of the basis for the recommendation.
- ◆ Include information about the characteristics of the work and the agreed-upon clearance area in the clearance examiner's report.

If the clearance examiner cannot obtain sufficient information on which to select Category 2 or 3 for interior clearance, the appropriate clearance category is Category 1.

B. Sampling of Rooms, Units or Areas

Note that, for the purposes of clearance sampling, hallways, stairways, entry rooms/lobbies and other significant definable spaces are considered “rooms” as well as spaces normally considered as rooms, such as bedrooms, bathrooms, living rooms, kitchens, dining rooms, family rooms. Similarly, for clearance sampling purposes, a hallway, lobby or other space within a multi-family building is considered a “unit” or a “room,” as applicable.

1. Sampling Rooms within a Unit

When conducting clearance in a single-family dwelling unit, the visual assessment should be conducted in all rooms and exterior work areas within the clearance area, unless the clearance is of the worksite only (Category 3), but if the clearance area contains more than four rooms it is not necessary to collect dust samples in every room or space.

For Category 1 clearance, if the work areas were not contained, all rooms in the unit must be sampled or represented by sampling. EPA and HUD regulations on clearance require that dust samples be collected in four selected rooms in the work area (or all of the work area rooms, if fewer than four), and allow additional rooms to be sampled. The rooms selected for dust sampling are intended to be those in which young children are most likely to be exposed to dust-lead hazards. These should include, as a higher priority, the rooms in which the work was done and, as a lower priority, those rooms in which the young children sleep and/or play. (See Section VI.C.2, below.)

For Category 2 clearance, in which dust has been contained to the work area, the sampling locations are the same as for single-surface sampling Category 1, above, plus one floor sample outside of, and within 10 feet of, each containment area, and one floor sample along each passageway used by workers walking to and from the work area.

For Category 3, worksite-only clearance, the clearance area includes at least the rooms in which work was done. If the work was done in one room, the room selection is the same as for Category 1, above. If the worksite-only clearance area contains more than one room, see Section VI.C.2, especially Table 15.1, for information on room selection and sampling locations.

If there are no dust-lead hazards in the selected rooms, it is assumed that there are no such hazards in the other, unsampled, rooms. If any of the selected rooms do have dust-lead hazards, it is assumed that the other, unsampled, rooms also have them. People performing hazard control, rehabilitation, maintenance, and associated cleanup work must *not* know which rooms will be sampled for dust. Section VI.C.2, below, provides detailed information on selecting rooms for dust sampling. Section IX, below, provides guidance on interpreting dust sampling results and when recleaning and resampling are needed.

Clearance examiners and their clients may, if they wish, choose to collect dust samples in more than four rooms. In addition, state, tribal and/or local requirements may require more rooms to be tested. Some clearance examiners prefer to sample in *all* rooms in which high-dust paint-disturbing work is done. This approach has higher initial costs for the clearance examiner’s time and laboratory analysis than does sampling in only four rooms, but it may save time and money in the long run because the greater amount of information allows a more focused and less costly recleaning and resampling effort if dust-lead levels exceed applicable standards.

2. Sampling Units within a Multi-family Property

If the clearance area encompasses many dwelling units in a large multi-family building or complex of similar buildings, random sampling of dwelling units, common areas and building exteriors is an option for both the visual assessment and dust sampling under the following conditions:

- ✦ For properties built during the period 1960-1977 (inclusive), random sampling of units is acceptable if the area to be cleared includes more than 10 dwelling units that have a common construction and painting history.
- ✦ For properties built before 1960, random unit sampling is acceptable if the area to be cleared includes more than 20 dwelling units that have a common construction and painting history.

This guidance applies most clearly to a large multi-family building, but it may also be applied to a group of single-family or a group of multi-family properties that are all of similar construction, were built at approximately the same time (i.e., within 2 or 3 years of each other), and have a similar painting history. If the number of units to be cleared is less than the applicable number indicated above (i.e., fewer than 11 or 21, depending on year of construction), all units must be sampled, because sampling fewer than all units would not be statistically reliable. Regardless of whether units and common areas are sampled, sampling of rooms within dwelling units should follow the guidance provided in Section IV.B.1, above, and in Section VI.C.2, below.

If the number of dwelling units in the clearance area qualifies for the unit sampling option (i.e., more than 10 dwelling units built between 1960 and 1977 (inclusive) or more than 20 units built before 1960), the visual assessment and the clearance dust sampling can be performed in randomly selected dwelling units, common areas and exterior surfaces. (The same approach is used for clearance of multiple common areas or exterior areas.) The random sampling can be performed for a portion of the housing development or for all of it. In either case the randomly selected units and common areas represent a specified group of housing units and common areas. The contractor must not know in advance which units and areas will be sampled, as this could bias the results, even if unconsciously. It is necessary to choose an adequate number of randomly selected units and common areas based on Table 7.3 of Chapter 7 and instructions associated with that table. Significant cost savings could be realized with such a sampling plan.

However, the implications of random clearance sampling should be understood fully before it is used. First, if the random sampling shows that levels of leaded dust are too high, it will be necessary to re-clean not only the affected rooms or components in the selected dwelling unit or units, but also in all the other units that the randomly selected units were meant to represent. Alternatively, all the unsampled units could be sampled individually to determine which need recleaning. The costs of repeated sampling should be compared with the costs of repeated cleaning. Regardless of whether all the represented units are sampled or recleaned, a further delay in permitting residents back into the area is possible when using random clearance sampling. Second, there has been a significant failure rate in attaining compliance with clearance dust standards. In the "Evaluation of the HUD Lead Hazard Control Grant Program" using the 1995 EPA interim guidance standards (see 60 FR 47248, September 11, 1995), with 2682 dwellings going through clearance, the failure rates at initial clearance were 20 percent for floors at 100 $\mu\text{g}/\text{ft}^2$; 6 percent for interior windowsills at 500 $\mu\text{g}/\text{ft}^2$; and 7 percent for window troughs at 800 $\mu\text{g}/\text{ft}^2$ (NCHH, 2004). In the HUD Abatement Demonstration Project using the earlier interim standards, failure rates on the initial wipe tests were 19 percent for floors at 200

$\mu\text{g}/\text{ft}^2$; 14 percent for windowsills at $500 \mu\text{g}/\text{ft}^2$; and 33 percent for window troughs at $800 \mu\text{g}/\text{ft}^2$ (HUD, 1991). In one large abatement job for a public housing authority, 15 percent of the housing units failed the clearance tests and required recleaning (Jacobs, 1993a). All of these failure rates were based on standards considerably higher, i.e., less stringent, than current EPA standards. These failure rates can be partially attributed to variable contractor performance.

In spite of all these caveats, there is one special situation that may lend itself well to random clearance sampling. A large vacant apartment building or housing development that will not be immediately reoccupied following the work could conceivably be randomly sampled at the end of the project and, if necessary, completely recleaned. Alternatively, all units could be sampled to determine which ones require recleaning.

Whether random clearance sampling or unit-by-unit clearance sampling is performed, repeated clearance sampling should *always* be performed in all units that required recleaning. In short, most cases of lead hazard control will require that clearance dust sampling be conducted in every unit treated. The basic exception is if less than *de minimis* amounts of painted surfaces are disturbed.

V. Visual Assessment

The visual assessment that is part of the standard EPA-HUD clearance procedure has two fundamental purposes: (1) to identify any remaining deteriorated paint that is or may be lead-based paint; and (2) to identify visible dust, paint chips; or paint-related debris. The clearance examiner should inspect painted surfaces and horizontal surfaces near such surfaces in both interior and exterior locations. Any deteriorated paint that is or may be lead-based must be repaired or stabilized and any visible dust, paint chips, or other paint-related debris must be removed before dust sampling can take place. A form for visual assessments can be found at the end of this chapter (see Form 15.1).

Determining that the lead hazard control work was actually performed as specified is an important initial step. This may be done by the owner, the owner's agent, or (except for work covered by the Lead Safe Housing Rule) the certified contractor/supervisor. This is usually the responsibility of the contractor and the owner, but the clearance examiner may be asked to make such a finding, such as through the clearance examiner's contract or work order. If so, the examiner must be informed in detail of the scope of the work before the work begins in order to be on the job site while the work is being performed. See Section VIII, below, for further guidance.

For a dwelling unit, the visual assessment of interior spaces and exterior surfaces should be exhaustive, covering the entire clearance area, before any sampling of rooms or other spaces or exterior surfaces is considered. If dwelling units and common areas are sampled in a multi-family property, however, the visual assessment need cover only the sampled units and common areas, but may include more or all units and areas.

A. Visual Assessment for Deteriorated Paint

The clearance examiner should identify all deteriorated paint in the clearance area, whether interior, exterior, or both. Deteriorated paint is defined by EPA as any interior or exterior paint or other coating that is peeling, chipping, chalking or cracking, or any paint or coating located on an interior or exterior surface or fixture that is otherwise damaged or separated from the substrate (40 CFR

745.63). Nail holes and hairline cracks are not considered deteriorated paint. Paint that is separated from other layers of paint or from the substrate may appear to be loose, peeling, chipping, flaking, bubbling, blistering, alligatoring, or seriously cracking. See Section II.D.3 of Chapter 5 for an illustrated discussion of various forms of paint deterioration.

EPA and HUD regulations include chalking as a form of paint deterioration. Therefore, clearance examiners must identify chalking paint. Chalking paint (usually found only on exterior paints) has been of concern because chalking may contaminate the ground and building surfaces below if the layer of paint that is chalking is lead-based. Chalking is usually manifested by discoloration of the wall or ground below the painted surface and by a chalk-like substance that comes off on the hand after lightly rubbing the paint surface.

All deteriorated paint should be recorded on a form, such as Form 15.1, the Visual Assessment – Lead Hazard Clearance Examination form (at the end of this chapter). Results should be written down as the assessment proceeds, and the report should be precise about amounts and locations. If deteriorated paint is found, the clearance examiner should ask the client why the paint is deteriorated. If the deteriorated paint is known not to be lead-based, the examiner should record that information, identify the document that is the basis for the determination, and proceed. If the client states that he or she is not required to repair that paint, the examiner may record that and proceed. It is not expected that the clearance examiner should be a compliance official, but the clearance record should show the client's explanations, if any, for the existence of deteriorated paint.

One example of a possible explanation for the existence of deteriorated paint might be that the property has undergone rehabilitation with Federal assistance of \$5,000 or less per dwelling unit. For such properties, HUD regulations (at 24 CFR 35.930(b)) do not require stabilization of deteriorated paint if that painted surface is not being addressed as part of the rehabilitation. Thus, for example, if the rehabilitation work is only window repair or replacement, deteriorated paint may remain on the walls near the windows – walls that are in the clearance area. A similar situation might occur in an unregulated renovation job of just part of a dwelling unit.

If the client does not know whether the deteriorated paint is or is not lead-based and has no other reasonable explanation for the presence of deteriorated paint, the paint surface should be made intact and the work area cleaned before completion of clearance. If the clearance area is an interior space, the paint must be repaired and the work area cleaned before collection of clearance dust samples because the paint repair might contaminate the area. Therefore, if there is any unexplained deteriorated paint, the clearance examiner should provide the client with a copy of the visual assessment form so it is clear exactly what paint should be repaired.

Tracking leaded dust from one area to another is a big problem on lead hazard control jobs. Leaded dust can be tracked on shoes from the work area to non-work areas or to the outside. Sometimes leaded dust from the outside soil is tracked into the work area. Leaded dust from a porch or non-work area can be tracked into a cleaned area. When this happens, the whole area must be cleaned. Accordingly, the clearance examiner and others visiting the worksite are advised to wear **disposable booties to minimize any cross contamination from one work area to another, or dust migration from outside the worksite into the worksite.**

B. Visual Assessment for Settled Dust and Debris

1. Interior

For an interior clearance area, there should be no evidence of settled dust or paint chips or paint-related debris following a cleanup effort. If dust, paint chips, or paint-related debris are observed, the clearance examiner should record his or her observations on a form, such as Form 15.1, and provide the form to the client. Remember to observe window troughs, as well as window sills and floors. These surfaces should all be clean because dust samples are collected from them. The client should have the relevant areas recleaned *before* clearance dust samples are collected to avoid conducting dust sampling twice. Visible settled dust provides sufficient evidence that cleanup was not adequate (see Figures 15.3 and 15.4). If recleaning is necessary, the clearance examiner should provide the client with a copy of the visual assessment form so it is clear exactly what areas should be recleaned.

There are conflicting reports regarding the use of the so-called “white-glove test,” named for the concept of running one’s hand in a white cotton glove along a surface to see how dusty or dirty it is, as part of the visual assessment. Some housing agencies have indicated that they find this to be a useful preliminary examination tool, while others indicate that this test almost always shows some discoloration of the glove, even if surfaces have been cleaned well. Until it has been demonstrated to effectively predict leaded dust levels, use of the “white glove test” is left to the discretion of the examiner and is not recommended by HUD. The “white glove test” is *not* a substitute for laboratory analysis of dust samples. Remember that the EPA has a cleaning verification method for projects covered by its RRP Rule (see Appendix 6) that are not covered by HUD’s Lead Safe Housing Rule.



FIGURE 15.3 Visible Dust Indicates Recleaning is Needed

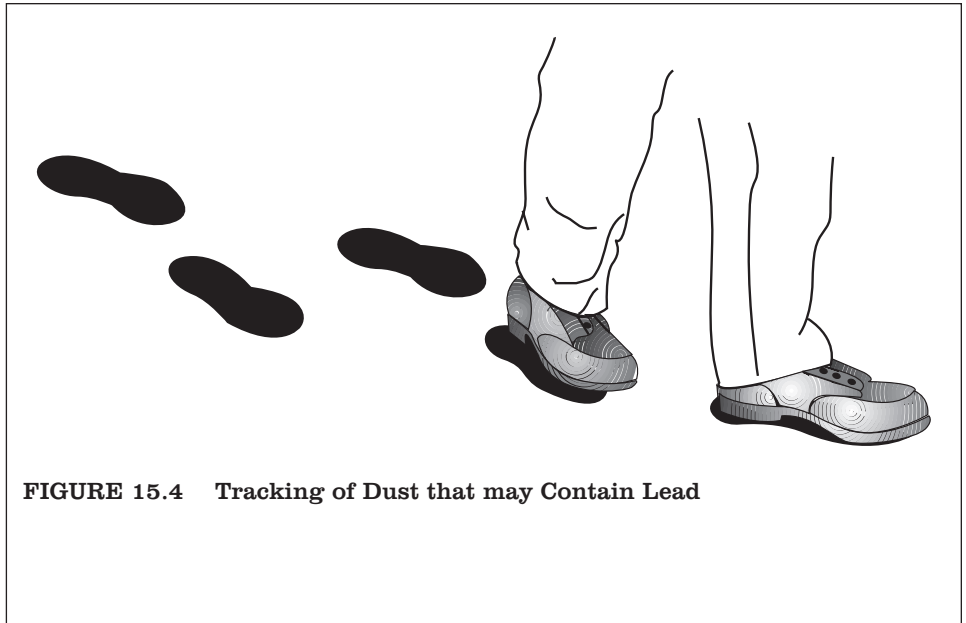


FIGURE 15.4 Tracking of Dust that may Contain Lead

2. Exterior

For an exterior clearance area, the clearance examiner, in addition to looking for deteriorated paint, should visually examine the ground, vegetation, and horizontal building surfaces (including exterior window sills) near the exterior work surfaces to determine that paint chips and other paint-related debris have been removed. Also, it is especially important that outdoor, hard-surfaced living areas such as porches, decks, and balconies that are within the clearance area and are frequented by children of less than six years of age be free of visible dust and debris. (See Section IV.A.2, above, for guidance on determining the area to be included in exterior clearance.) A visual examination of the surface for surface dust, debris and residue is usually adequate. It is not necessary to turn over or rake soil to look for paint chips unless the clearance examiner has reason to believe workers or the client may have covered up paint chips or other lead-contaminated debris with loose soil.

If exterior cleanup is necessary, the clearance examiner should provide the client with a visual assessment form explaining exactly what areas and what material must be cleaned up. Clearance has not been achieved until such cleanup has been satisfactorily completed. However, it is usually not necessary to postpone interior dust testing until exterior cleanup has been completed, provided building openings are closed during the exterior cleanup to avoid possible contamination of interior spaces. The clearance examiner should tell the client it is necessary to close building openings within 10 to 20 feet of the exterior cleanup.

C. Completion of the Visual Assessment Form

The Form 15.1 for visual assessments should be completed, signed, and dated. If no unexplained deteriorated paint or visible dust, paint chips, or paint-related debris are observed, the clearance examiner can proceed to dust sampling and analysis. If, on the other hand, further paint treatment or cleanup is required, the examiner should provide the client with such observations on a dated and signed form; and it will be necessary for the clearance examiner to return after the repair and cleanup is done, conduct another visual assessment, and complete, sign, and date a second visual assessment form to document the presence or absence of unexplained deteriorated paint. Dust sampling should not be performed until the examiner observes that the paint repair and cleanup has been satisfactorily done.

VI. Clearance Dust Sampling

A visual assessment alone is not adequate for determining if a residence is safe for occupancy, because small dust particles are not visible to the naked eye. A person with normal eyesight cannot detect individual dust particles smaller than 50 μm in diameter (Olishifski, 1983). Data indicate that a significant percentage of the dust generated during lead hazard control work is smaller than 50 μm (Mamane, 1994; NIOSH 1993b). Because these smaller dust particles are associated with an increased risk of lead poisoning, clearance dust testing is required to determine quantitatively if a leaded dust hazard remains following lead hazard control work. The dust testing involves two steps: sampling the dust, and analyzing the dust for lead.

A. Sampling Methods

1. Wipe Sampling

Dust samples must be collected using wet wipes. The recommended protocol for sample collection is either Appendix 13.1 of these *Guidelines*; ASTM Standard Practice E 1728,

“Standard Practice for Field Collection of Settled Dust Samples Using Wipe Sampling Methods for Lead Determination by Atomic Spectrometry Techniques”; or the EPA report, “Residential Sampling for Lead: Protocols for Dust and Soil Sampling,” March 1995 (EPA, 1995a).

Neither EPA nor HUD currently recognizes a standard for collecting and evaluating vacuum samples of dust as a part of a lead-based paint hazard risk assessment or clearance examination. Wipe sampling yields a measure of dust-lead loading (in micrograms of lead per square foot or square meter), whereas vacuum sampling can provide a measure of the concentration of lead in the dust (in parts per million or micrograms per gram) as well as loading. Wipe sampling, however, is the required method of dust collection because it is simple, inexpensive, and has been used successfully for a number of years. Research has indicated that wipe sampling results correlate well with blood-lead levels in children (Lanphear, 1994; Farfel, 1992). The wipe sampling protocols in Appendix 13.1 and in ASTM E 1728 are equivalent to the method used in the Lanphear study.

Clearance wipe samples must be analyzed for lead by a laboratory recognized by the EPA under the National Lead Laboratory Accreditation Program (NLLAP) for analysis of lead in dust with one exception. The exception is for analyzing samples collected where States or Tribes operate an EPA-authorized lead-based paint inspection certification program that has paint testing requirements different from the EPA requirements, in which case the State or Tribal requirements must be followed. NLLAP-recognized laboratories are required to use the same analytical methods for analyzing the sample that they used to obtain NLLAP recognition.

- ◆ EPA established NLLAP to provide the public with laboratories that have a demonstrated capability for analyzing lead in paint-chip, dust, and/or soil samples at the levels of concern stated in these *Guidelines*. NLLAP monitors the analytical proficiency, management and quality control procedures of each laboratory participating in the program. NLLAP does not specify or recommend analytical methods.
- ◆ See Chapter VII, Section VI.I for further information of NLLAP procedures.
- ◆ Field-portable XRF analysis has been used for measurement of lead in dust (Sterling, 2000; Harper, 2002) or soil (EPA, 2004; Binstock, 2009) with varying degrees of success; these methods do involve collecting a sample of the medium, so samples collected from target housing or pre-1978 child-occupied facilities, must be analyzed by a laboratory recognized by NLLAP for analysis of lead in the particular medium. The laboratory may be a mobile laboratory, field sampling and measurement organization, or a fixed-site laboratory, as discussed in Section II.E.6, above.

Information on this program, including an up-to-date list of fixed-site and mobile laboratories recognized by NLLAP, can be obtained on the EPA web site at <http://www.epa.gov/lead/pubs/nllap.htm>, or by calling the National Lead Information Center at 800-424-LEAD. (Hearing- or speech-challenged individuals may access this number through TTY by calling the toll-free Federal Relay Service at 800-877-8339.)

2. Composite Sampling

Under EPA and HUD regulations, dust wipe samples may be either single surface or composite. Each single-surface sample is a separate wipe from a specific location. It is placed in a separate container and is analyzed separately. A composite sample can contain up to four wipes from four

different locations, but the locations must be from the same type of component, e.g., hard floors from four different rooms, or interior window sills from four different rooms. Wipe samples are composited in the field, not in the laboratory, by inserting up to four wipes from four surfaces into the same container. The laboratory analyzes all four wipes as one sample using a modified analytical procedure. The individual wipes in each composite are called “subsamples.”

Acceptable recovery rates (i.e., within the range of 80 to 120 percent of the “true” value) have been found when no more than four wipes are analyzed as a single sample (EPA, 2001b; Jacobs, 1993c). Testing reported in 2011 among multiple NLLAP-recognized laboratories identified two sample preparation methods for four-wipe composite dust wipe samples that are capable of meeting NLLAP requirements for accuracy (recovery) and precision. (White, 2011)

In 2011, the American Industrial Hygiene Association Laboratory Accreditation Programs, LLC revised the “Specific Additional Requirements” in Policy Module 2C for its Environmental Lead Laboratory Accreditation Program (ELLAP). Laboratories accredited by ELLAP for lead analysis of dust wipes are recognized by NLLAP (and similarly for lead in paint chips and soil). As of the publication of these *Guidelines*, the ELLAP policy covers accreditation (and, hence NLLAP recognition) of laboratories analyzing composited wipes, for which “all requirements for wipes listed in Policy Module 2C apply, but with the additional requirement that each batch of samples and associated QC samples shall contain the same number of wipes, i.e. composited samples that contain two wipes are to be analyzed in a batch containing QC samples to which two wipes were added as matrix.” (ELLAP policy 2C.4.12, which is linked from <http://www.aihaaccreditedlabs.org/PolicyModules/Pages/2011%20Policy%20Modules.aspx>. Additional composite-specific requirements are found in the ELLAP application form linked from <http://www.aihaaccreditedlabs.org/programfees-guidelines-forms/Pages/default.aspx>.)

While these *Guidelines* recognize the use of composite sampling of dust, they generally do not encourage it for the following reasons:

- ◆ Most laboratories that are recognized by EPA for lead analysis (i.e., NLLAP-recognized laboratories) discourage clients from submitting composite dust wipe samples.
- ◆ The lack of an inter-laboratory proficiency program for analysis of composited samples may make the data less convincing in case of a dispute.
- ◆ Compositing offers only limited amount of information. If one composite sample has dust lead levels exceeding applicable standards, all components represented by that composite sample will have to be recleaned, or each room will need to be resampled individually. In contrast, if one of the single-surface samples fails, recleaning is necessary only in the room in which the failed sample was taken plus all unsampled rooms (or each unsampled room could be sampled).
- ◆ The decision criterion for evaluating the results of composite clearance samples is more stringent than that for single-surface samples. In accordance with EPA regulations, the EPA standard for dust-lead hazards must be divided by one-half of the number of subsamples to determine the standard against which the results of a composite clearance sample must be evaluated (40 CFR 745.227(e)(8)(vii)). Thus, with the EPA dust-lead hazard level for floors being 40 µg/sq. ft. as of the publication of these *Guidelines*, the standard for a composite floor sample with four subsamples is 20 µg/sq. ft. Such a low composite standard increases the likelihood of failing clearance.

- ◆ Laboratories often separate composite samples and analyze each wipe separately because their equipment and sample preparation procedures are set up for individual wipes, rather than analyzing the composited samples together. As a result, the cost of the composite analysis may well be at least as high as for analyzing the wipes submitted as separate samples.
- ◆ The cost of single-surface sampling has declined since the 1990s, so the money spent in single-surface samples is more than made up by having good data.

Research has shown the benefit of composite dust wipe testing for the case of high-dust jobs involving lead-based paint. (Cox, 2011) For such jobs, lead in dust next to the walls was three times more difficult to clean than lead in dust nearer the center of the rooms; clearance using single-wipe samples collected next to the walls was much more likely to fail; and “four-wipe composite sampling within each room (two randomly selected from the perimeter and two randomly selected from the interior) provided a very reliable method for detecting clearance failure (99% or greater) versus a randomly selected single wipe sample per room (50% or less).”

The following recommendations should be observed if composite dust wipe sampling is conducted:

- ◆ Wipes used for composite dust wipe samples should meet the requirements of ASTM Standard E 1792.
- ◆ Whenever composite sampling is contemplated, clearance examiners should check with the analytical laboratory to determine whether it analyzes composite samples and, if so, whether special quality assurance practices are needed. For example, clearance examiners should confirm whether the laboratory is able to analyze composite samples with wipes that meet ASTM Standard E 1792 (Battelle, 2002).
- ◆ A single composite sample should not contain subsamples from different component types, e.g., floors and interior window sills, in the same composite sample.
- ◆ When composite samples are being taken, separate composite samples are required for each dwelling unit sampled.
- ◆ The surface areas of subsamples within a composite sample must be very similar in order to avoid oversampling a room.
- ◆ All the areas to be wiped for a composite sample should be identified before starting to perform the wiping for the subsamples. After preparing the container for a composite sample, put on the glove(s) and complete the wiping procedures for all subsamples.
- ◆ A new wipe should always be used for each spot sampled. Carefully insert each wipe subsample into the same container.
- ◆ No more than four different wipes should be inserted into a single container for a composite sample. As noted above, acceptable recovery rates (i.e., within the range of 80 to 120 percent of the “true” value) have been found when no more than four wipes are analyzed as a single sample (EPA, 2001b; Jacobs, 1993c).

- ◆ Composite samples should not be taken from rooms that have dramatically different conditions. For example, if the clearance examiner has some reason to believe that cleanup was not performed adequately in a room, a single-surface sample should be collected there. In some cases both single-surface samples and composite samples may be needed for the same component.

3. On-site Dust Testing

EPA and HUD allow on-site analysis of dust samples as long as the laboratory analyzing the samples is recognized for on-site ("mobile") analysis of lead in dust by EPA under the National Lead Laboratory Accreditation Program (NLLAP). Methods exist for reliably screening wipe samples on-site rather than in a fixed laboratory; note that this preliminary screening is not the same as clearance, but may be used by the owner, contractor or clearance examiner as part of determining whether to proceed to clearance testing. These include portable X-ray fluorescence (XRF) analysis and anodic stripping voltammetry (ASV) (Ashley 2001; EPA, 2002b; Clark, 2002). These methods may provide testing results much more quickly than fixed laboratory analysis, and so they may save time and money, reduce relocation difficulties, facilitate cooperation by both landlords and tenants, and accelerate environmental investigations in cases of children with elevated blood-lead levels.

In States and Tribal lands where EPA is operating a lead certification program, wipe samples for a clearance examination must be analyzed by a laboratory recognized by EPA under the National Lead Laboratory Accreditation Program (NLLAP) for analysis of lead in dust. If, in these States, an EPA-recognized laboratory wishes to perform on-site analyses of dust wipe samples, it may do so. In States or Tribal lands where the State or tribe is operating an EPA-authorized lead program, the same requirements generally apply, although there may be some differences (EPA, 2002a). While EPA clearance regulations and program procedures apply only to abatement activities (and the option for clearance in projects covered by the RRP Rule), HUD regulations and many State regulations apply the same procedures to non-abatement activities. On-site analysis (just like fixed-site laboratory analysis) of dust for lead for clearance testing (or for risk assessment or lead hazard screening) of target housing may only be done by an NLLAP-recognized laboratory. Thus a certified risk assessor, lead-based paint inspector, or sampling technician who wishes to conduct on-site dust testing as part of a clearance examination must conduct the analysis as part of working for an NLLAP-recognized laboratory, whether as an employee or a subcontractor of the laboratory.

Any person who is trained and otherwise qualified (e.g., holding a state radiation license) to operate the XRF instrument, or use the ASV or PSA method may use these methods to conduct dust testing in a preliminary screening to determine whether the clearance area is clean and ready for the clearance examination. A person conducting a preliminary screen does not have to be a certified lead-based paint inspector, certified risk assessor, or a certified dust sampling technician. To conduct a clearance examination or a risk assessment, however, one must be certified. Owners and contractors may wish to use appropriately certified individuals to conduct such screening tests to minimize the likelihood of clearance failure. State regulations on the use of devices with radioactive elements must be observed.

B. Clearance Dust Sampling and Sealant Application

Wipe samples should be collected after any application of a sealant on a rough, unfinished, horizontal surface, such as a floor or window sill, not before. In lead hazard control programs, and especially after paint removal, coating with a sealant is often one of the final measures completed. It is recommended for wood and concrete surfaces that are not coated with paint, varnish, polyurethane, or other coating. The purpose of sealing floors or sills is not to trap leaded-dust underneath the sealant, but to provide a surface that can be cleaned effectively by the resident. The type of surface determines the type of sealant. For example, wooden floors should either be painted with deck enamel or coated with polyurethane; concrete floors should be sealed with a concrete sealant; and tile floors should be sealed with appropriate wax or other coating. The lead-safe maintenance program should check the integrity of floor sealants at least yearly.

C. Location and Number of Clearance Dust Samples

Table 15.1 presents the minimum number and location of clearance dust samples to be taken in various circumstances. The number and location of samples depend on several factors: whether dust containment was used, the number of rooms in the clearance area, whether composite or single-surface samples are collected, and whether the clearance protocol must be a standard HUD-EPA protocol or can be a special worksite-only protocol that may be acceptable in certain circumstances.

1. Clearance Categories

The four categories of clearance are shown in Table 15.1. Remember that clearance is not required following small work in which the amount of paint disturbed is less than the *de minimis* amounts defined in Section I.C, above.

Clearance Category 1 in the Table 15.1 is the standard HUD-EPA dust sampling protocol for clearance after interior work that has not used dust containment between work areas and non-work areas. Dust containment generally includes temporarily turning off HVAC systems, sealing vents, and installing plastic sheeting over doors to rooms in which work is being done. See Chapter 8 for guidance on containment to minimize dust migration. Also, clearance examiners should use Clearance Category 1 if information on the location and design of containment is not available.

Clearance Category 2 in Table 15.1 is the standard HUD-EPA dust sampling protocol for clearance after interior work that has used dust containment between work areas and non-work areas. Categories 1 and 2 constitute the recommended protocol for dust sampling in most clearance examinations. Categories 1 or 2 must be used if the work includes abatement of lead-based paint hazards, as defined and regulated by EPA and State or Tribal programs authorized by EPA. Categories 1 or 2 must also be used if the clearance is required by the HUD Lead Safe Housing Rule, except in certain cases in which worksite-only clearance is also permitted.

Clearance Category 3 in Table 15.1 is the recommended dust sampling protocol for worksite-only clearance following a small amount of interior work that was of short duration, generated little dust, and was contained. The HUD Lead Safe Housing Rule allows this worksite-only clearance procedure in housing receiving up to \$5,000 per housing unit in Federal rehabilitation assistance and also in housing that is receiving certain other types of Federal assistance and is undergoing continuing lead-based paint maintenance. The EPA does not allow worksite-only

clearance after abatement work in States for which it operates the lead certification program. (See also sec. VI.C.5.) EPA does allow the option of clearance on work covered by the RRP Rule (40 CFR 745.85(c).); if there is no other requirement (such as from HUD's Lead Safe Housing Rule, or a State or tribal regulation) to clear the entire unit, worksite-only clearance is allowed.

Clearance Category 4 in Table 15.1 pertains to exterior paint-disturbing work. Dust sampling of exterior locations is not required. Dust testing of exterior living areas, such as porches and balconies, is optional. There is no EPA dust-lead hazard standard for exterior surfaces. Dust sampling of interior rooms is necessary, however, if building openings near the work surfaces are not sealed or tightly closed during the work to preclude the migration of work-generated dust into interior spaces. The clearance examiner must exercise professional judgment in selecting rooms that may have been contaminated during the work.

Each of these clearance categories has different dust sampling protocols, depending on whether the wipe samples being taken are single-surface or composite.

The recommended number and location of dust samples is the same for dwelling units, common areas, and child-occupied facilities. A child-occupied facility is defined by EPA as "a building or portion of a building, constructed prior to 1978, visited regularly by the same child, 6 years of age or under, on at least two different days within any week (Sunday through Saturday period), provided that each day's visit lasts at least 3 hours and the combined weekly visit lasts at least 6 hours, and the combined annual visits last at least 60 hours (see Figure 15.5). Child-occupied facilities may include, but are not limited to, day-care centers, preschools and kindergarten classrooms" (40 CFR 745.223).

Once a clearance examiner has determined which clearance category(ies) apply to the job at hand, he or she then has the following decisions to make: (1) which rooms to sample; (2) which locations within rooms to sample; and (3) whether to use single-surface or composite samples. If the clearance examiner wishes to take samples above the minimum required, she or he must first ensure that the owner or owner's agent paying for the clearance examination agrees to the collection and analysis of the additional samples. These issues are discussed in the following paragraphs.



FIGURE 15.5 Indications that children are present.

Table 15.1 Minimum Number and Location of Dust Samples

Clearance Category	Number and Location of Single-Surface Wipe Samples	Number and Location of Composite Wipe Samples*
<p>Category 1: Standard HUD-EPA clearance protocol following interior work with no dust containment.</p>	<p>The clearance area is the entire dwelling unit, common area, or child-care facility. If the clearance area contains four or fewer rooms, all rooms must be sampled. If there are more than four rooms, select at least four rooms for sampling.</p> <p>If the unit, common area, or facility being cleared consists of two or more rooms, collect two samples from each room selected for sampling:</p> <ul style="list-style-type: none"> ◆ One from the floor. ◆ One from an interior window sill or window trough, if present, alternating from sill to trough between rooms. <p>If the unit, common area, or facility being cleared consists of only one room, collect three samples: an interior window sill (if present), a window trough (if present), and the floor.</p>	<p>The clearance area, the number of rooms to be sampled, and room selection are the SAME as for Category 1 single-surface sampling.</p> <p>If the unit, common area, or facility being cleared consists of two or more rooms, collect three subsamples from each room to be sampled:</p> <ul style="list-style-type: none"> ◆ One from the floor. ◆ One from an interior window sill, if present. ◆ One from a window trough, if present. <p>If the unit, common area, or facility being cleared consists of only one room, sampling locations are the same as for Category 1 single-surface sampling locations; composite samples cannot be taken.</p>
<p>Category 2: Standard HUD-EPA clearance protocol for interior work with dust containment.</p>	<p>The minimum clearance area includes the rooms in which work was done, the area outside each containment area, and each passageway used by workers walking to and from the work area.</p> <p>Sampling locations are the same as for single-surface sampling Category 1, plus:</p> <ul style="list-style-type: none"> ◆ One floor sample outside of, and within 10 feet of, each containment area. ◆ One floor sample along each passageway used by workers walking to and from the work area. 	<p>The minimum clearance area is the SAME as for single-surface sampling Category 2 single-surface sampling;</p> <p>If work was done in more than one room, collect:</p> <ul style="list-style-type: none"> ◆ Three subsamples from each room to be sampled: ◆ One from the floor. ◆ One from an interior window sill, if present. ◆ One from a window trough, if present. ◆ One floor sample outside of, and within 10 feet of, each containment area.

<p>Category 2: Standard HUD-EPA clearance protocol for interior work with dust containment.</p>		<ul style="list-style-type: none"> ◆ One floor sample along each passageway used by workers walking to and from the work area. <p>If work was done in only one room, all samples must be Category 2 single-surface samples; composite samples cannot be taken.</p>
<p>Category 3: Worksite-only clearance for a small amount of interior work of short duration, with low dust generation and dust containment.</p>	<p>The minimum clearance area includes the rooms in which work was done. Room selection is the same as single-surface sampling Category 2.</p> <p>If the clearance area contains more than one room, collect three samples from each room to be sampled:</p> <ul style="list-style-type: none"> ◆ One from the floor within 5 feet of a work surface. ◆ One from an interior window sill or window trough, if present, alternating between rooms. ◆ One from the floor near the main doorway used by workers to access the room. <p>If work was done in only one room, collect four samples: two from the floor (in the same locations as above), one from a sill (if present), and one from a trough (if present).</p>	<p>The minimum clearance area, the number of rooms to be sampled, and room selection are the SAME as for Category 3 single-surface sampling.</p> <p>If the clearance area contains more than one room, collect four subsamples from each room to be sampled:</p> <ul style="list-style-type: none"> ◆ One from the floor, within 5 feet of a work surface. ◆ One from an interior window sill, if present. ◆ One from a window trough, if present. ◆ One from the floor near the main doorway used by workers to access the room. <p>If work was done in only one room, all samples must be Category 3 single-surface samples.</p>
<p>Category 4: Exterior paint-disturbing work.</p>	<p>Dust sampling is generally not required for exterior work if building openings near the work surfaces were tightly closed or sealed during the work.</p> <p>Optionally, collect one floor sample from each porch or balcony where children under age 6 play and paint-disturbing work was done.</p> <p>If building openings near the work surfaces were not sealed or tightly closed, conduct Category 1 interior dust sampling in rooms that may have been contaminated.</p>	<p>SAME as for Category 4 single-surface sampling.</p>

* These Guidelines generally do not encourage collection of composite dust-wipe samples for the reasons stated above in Section VI.A.2, but they are permitted under Federal regulations.

2. Selection of Rooms

For the purposes of clearance sampling, hallways, stairways, entry rooms/lobbies, and other significant definable spaces are considered “rooms” in addition to bedrooms, bathrooms, living rooms, kitchens, dining rooms, and family rooms. Closets are not considered to be separate rooms unless they are unusually large. Most closets are considered to be part of the room to which they are attached.

If the clearance area includes one to four rooms, all rooms must be sampled. If the clearance area includes more than four rooms in a dwelling unit, the clearance examiner may select just four rooms to sample, and those rooms will represent all rooms within the clearance area. Clearance examiners and their clients may, if they wish, choose to collect dust samples in more than the minimum number of four rooms. If the clearance area contains more than four rooms, sampling all rooms in the clearance area with single-surface samples, although more expensive, gives the most information and permits targeted recleaning if any of the samples fail. Time and labor costs saved in recleaning might justify the added cost of dust sampling. An alternative to sampling in all rooms is to sample in those rooms in which high-dust paint-disturbing work has been done.

If the clearance area contains more than four rooms, the selection of four rooms for clearance dust sampling requires judgment. Two questions should guide the clearance examiner in selecting rooms to be sampled:

- (1) Where was the work done?
- (2) Where do young children spend their time?

Of the two, the first is the more important for clearance dust sampling. The first priority is to sample rooms where most of the dust-generating work was done. If that criterion is not sufficient, however, the clearance examiner should select rooms where children less than six years old spend the most time. If no information on children’s activity patterns is available or no young children are currently living in a dwelling unit, the following rooms can be considered as having frequent child contact: the bedroom that the youngest child would be likely to occupy (usually the smallest), the family room or play room, the kitchen, the living room, and the dining room.

Thus, if, for example, there are more than four rooms in the clearance area and paint-disturbing work was done in all the rooms, the clearance examiner should select rooms according to where, in his or her judgment, the most dust-generating work was done. If the work done in the various rooms did not vary much in dust generation, or if there is inadequate information on which to judge likely dust generation, the selection of rooms should be based on where children spend the most time. If only one, two or three rooms in the clearance area were work areas, those rooms should be selected, and then additional rooms should be selected according to where young children spend time. If exactly four rooms in the clearance area were worksites, those four should be selected.

Although the same general principles apply for common areas as for dwelling units, it is recommended that all rooms in the clearance area of common areas be selected if the rooms vary widely in size, construction, age, configuration, or use.

3. Selection of Locations Within Rooms

Within rooms, clearance dust samples must be taken from floors (see figure 15.6), interior window sills (if present, see Figure 15.7) and window troughs (if present). One floor sample or subsample must be collected in each sampled room. In multi-room clearance examinations using single-surface sampling, the clearance examiner should alternate sampling sills and troughs, i.e., collect a sill sample in one room, a trough sample in the next, and so forth. Where rooms have more than one window, the window to be sampled should be alternated from room to room to avoid bias in sampling. There are several ways to choose which window(s) to sample. For example, sample the rightmost window in the first room, the next one to the left in the next room, and so on, starting over when the leftmost window is reached. Similarly, sampling can start with the leftmost window and move rightward. The windows can also be randomly sampled using a random number generated by coin-flips, a die, a calculator or a computer spreadsheet. Thus, in multi-room clearance areas, a minimum of two single-surface wipe samples must be taken in each sampled room if the room has a window that can be sampled: one floor sample and one sample from either the sill or the trough.

If composite sampling is used, alternating between the sill and trough is not recommended; subsamples of each composite sample should be collected from the same component type in each sampled room. In single-room clearance areas, both the sill and the trough should be sampled, so three wipe samples must be taken in the room.

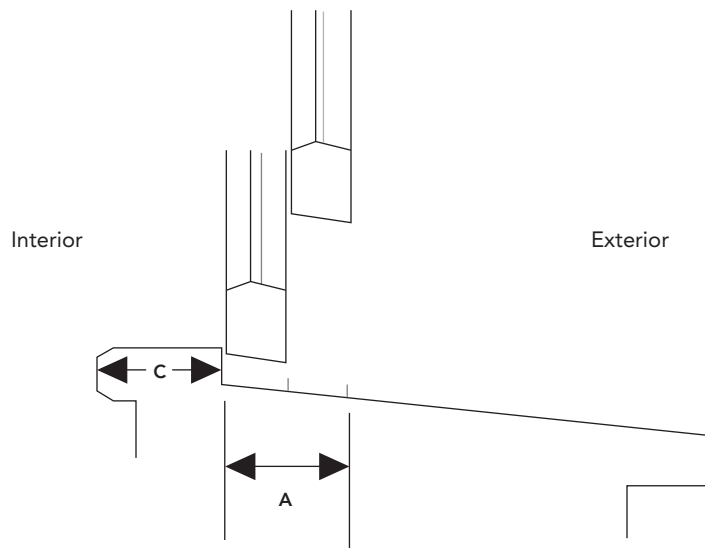
An interior window sill (sometimes called the stool) is the window ledge in front of the bottom of the closed window sash as seen while looking out the window (see Figure 15.7 for an illustration). A double-hung window has two parts that move up and down in the window frame. A window trough is the part of the window sill in which both sashes of a double-hung sash sit when lowered or, for a casement window, where the bottom of the casement sash is when it is closed, commonly called the well. If there is a frame for a storm window or a screen, the trough extends out to such a frame (see Figure 15.8). Do not sample the exterior



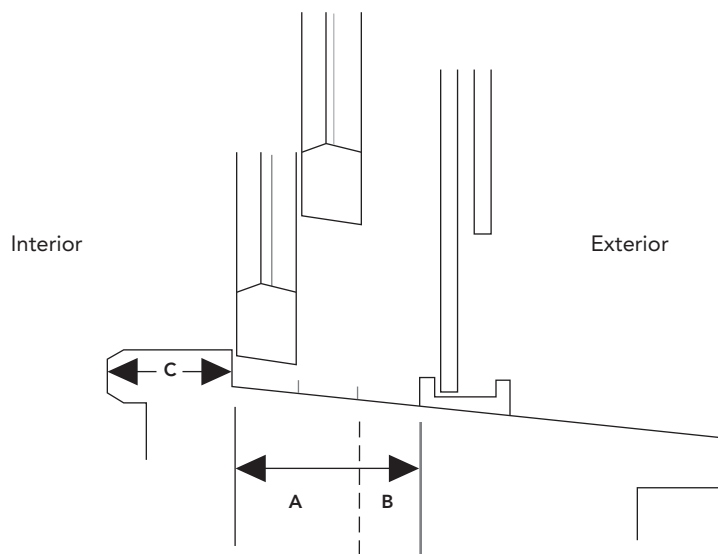
FIGURE 15.6 A floor that may be tested.



FIGURE 15.7 A window sill and trough that may be tested.



1. Sectional view of window (with no storm window) showing window trough area, A, to be tested. Trough is the surface where both window sashes can touch the sill when lowered. The interior window sill (Stool) is shown as area C. Interior window sills and window troughs should be sampled separately.



2. Sectional view of window (including storm window) showing window trough area, A and B, to be tested. Trough extends out to storm window frame. The interior window sill (stool) is shown as area C. Interior window sills and window troughs should be sampled separately.

Courtesy: Warren Fredman

FIGURE 15.8 Window Locations for Dust Sampling.

window sill outside of the trough. EPA has not established a dust-lead hazard standard for exterior window sills. They are usually washed by rain and do not have the same dust-lead loadings as troughs.

Clearance examiners must exercise judgment in selecting the exact locations in a room from which to collect wipe samples on the floor, interior window sill, or window trough. Generally, samples should be taken either from locations near the area where the work was done, from nearby high-traffic areas (around doorways, for example), or from areas with which young children are likely to be in contact. Floor dust samples may be taken from either carpeted floors or hard-surfaced floors. The clearance examiner may determine which specific site is best based on the type of treatment, visual observation, and professional judgment.

Those performing the work must not know exactly where the clearance samples will be collected.

4. Sampling Outside the Containment Area

If dust containment is used (i.e., sealing vents and installing plastic sheeting on doors between work areas and non-work areas), one floor sample must be taken outside each containment area if the clearance area is defined as being within the containment. The floor sample should be taken within 10 feet of the containment to determine the effectiveness of the containment.

If dust containment is used, one floor sample must also be taken along each passageway used by workers walking to and from the work area, to determine the effectiveness of measures taken to control the tracking of leaded dust.

5. Worksite-Only Sampling

For small, low-dust non-abatement jobs, the certified renovator (or, for jobs not covered by the abatement or RRP rules, the project supervisor) is responsible for designing the containment system that will be used. In some cases, it may be acceptable for containment to consist of merely tape plastic sheeting on the floor extending at least 6 feet from the surface being worked on, and not install further containment. A low-dust job is defined generally as work that creates a small amount of dust that will not spread beyond 6 feet from the painted surfaces being disturbed. This set-up may be acceptable for such jobs as small repainting work that does not require scraping of large areas, or window replacement, if dust-limiting work practices are used. See Table 8.1 in Chapter 8 for guidance on work-site preparation. This set-up is not acceptable if an EPA-regulated abatement is performed, and it is not acceptable for high-dust jobs involving the scraping of large painted areas or the demolition of walls or ceilings or other large components.

The clearance examiner should take two floor dust samples in each room or space where work was done:

- ◆ One floor sample should be taken within 5 feet of the surface(s) that were worked on. This sample is to determine whether a significant amount of dust generated by the work remains nearby after the work and cleanup. If work was done on surfaces more than 10 feet apart, the sample should be taken near where the clearance examiner expects the greatest amount of dust to have been generated.

Another floor sample should be taken near the door that workers usually used, if this is known or can be reasonably presumed based on the work location, the room layout, material storage and holding locations, etc. If the workers' entering and exiting pattern is not known or cannot be presumed, the sample should be taken near the main door to the room or space. This sample is to determine whether workers tracked lead-contaminated dust into the unprotected part of the room or space.

- ◆ In addition, one should be taken from a window sill (if present) and one from a window trough (if present).

6. Composite Sampling: An Example

When the work is similar in a clearance area with multiple rooms in the same dwelling unit or child-occupied facility, or in multiple common areas of the same property, composite clearance dust samples may be collected.

An example of a composite sampling scheme is as follows: A house has undergone an abatement job involving extensive interior paint removal and has passed a visual examination. Before the work began, the owner and the clearance examiner have agreed to use composite clearance dust sampling to minimize initial laboratory expenses, based on the dust-lead analysis price schedule of the EPA-recognized laboratory being used. (Remember that the laboratory may charge based on the number of composite subsamples, which may eliminate any composite sample discount.) The house has eight rooms that were treated, four of which are carpeted, and all of which have windows. Two of the four rooms selected for sampling have carpets; two do not. At a minimum, the clearance examiner should collect the following samples:

- ◆ One composite carpeted-floor sample, with one subsample from each of the two carpeted rooms in the room sample.
- ◆ One composite hard-floor sample, with one subsample from each of the two uncarpeted rooms in the room sample.
- ◆ One composite interior window sill sample, with one subsample collected from each of the four selected rooms.
- ◆ One composite window trough sample, with one subsample collected from each of the four selected rooms.
- ◆ One field blank sample for quality assurance.

This results in a total of four composite samples, plus one field blank, for a total of five analyses. If single-surface sampling had been completed under the recommendations in Table 15.1, nine samples would be analyzed (four rooms x two samples/room, + one field blank = nine samples/dwelling).

D. Securing the Clearance Area

The clearance area should not be occupied until the results of the laboratory analysis of dust samples have been received and the clearance examiner has found that the area has dust-lead levels below the clearance standard(s). It is especially important that children not enter the area. In most cases, closing and preferably locking of doors to the area and the use of yellow construction-area hazard

tape should be sufficient. In circumstances where young children are likely not to be deterred by such methods and experience indicates that lead hazards may be present, it is recommended that components with a possibility of hazards be covered with a layer of plastic sheeting.

VII. Clearance Soil Sampling (optional)

A. Considerations for Sampling Soil Before the Work

It may be necessary to collect samples from soil that is not bare to determine if contamination has occurred. While it is generally preferable to sample bare soil, sampling covered soil is acceptable because the purpose of such sampling is not to identify a “lead-based paint hazard,” but rather to determine if dust containment practices were adequate.

If soil lead levels after the work are below applicable soil lead hazard limits, the pre-abatement samples need not be analyzed. The hazard levels for soil are 400 $\mu\text{g/g}$ for play areas and 1200 $\mu\text{g/g}$ for the rest of the yard. If soil lead clearance levels are greater than or equal to the applicable limits, the baseline samples should be analyzed to determine if soil lead levels were already high before the work began. The decision to conduct soil treatment may depend on applicable regulations and/or the goals of the owner, contractor, or public agency.

B. Considerations for Sampling Soil After the Work

Neither EPA nor HUD requires any soil sampling as part of a clearance examination. If work that disturbs exterior paint has been performed, it is sufficient to conduct a visual examination to assure that there are no visible paint chips and other paint-related debris on the ground or on horizontal building surfaces (including exterior window sills) near the work surfaces. Horizontal building surfaces in outdoor living areas close to the work areas, such as porches or balconies, should also be free of visible dust as well as paint chips and paint-related debris.

Soil sampling, however, should be conducted if, contrary to the prohibitions of EPA and HUD regulations and the recommendations of these *Guidelines*, exterior paint was removed by abrasive blasting, power washing or large-scale power sanding without local HEPA exhaust and full containment.

There should be no visible paint chips, visible surface dust, debris or residue on the surface of the soil near the foundation before clearance soil samples are taken. Visible paint chips should be picked up with a vacuum or by hand before soil sampling. However, soil sampling near the foundations of dwellings is often complicated by the presence of paint chips embedded in or under the soil surface from previous repainting efforts. The hazard associated with these paint chips in the soil is difficult to assess since it is often not practical to sample all the different paint chips that may be present. Therefore, these paint chips should be considered a part of the soil. They should not be sampled preferentially or excluded when collecting or analyzing the soil. Laboratories should be instructed to disaggregate (force) paint chips through the soil sieve as part of the analytical process so that paint chips remain part of the soil matrix into which they are embedded.

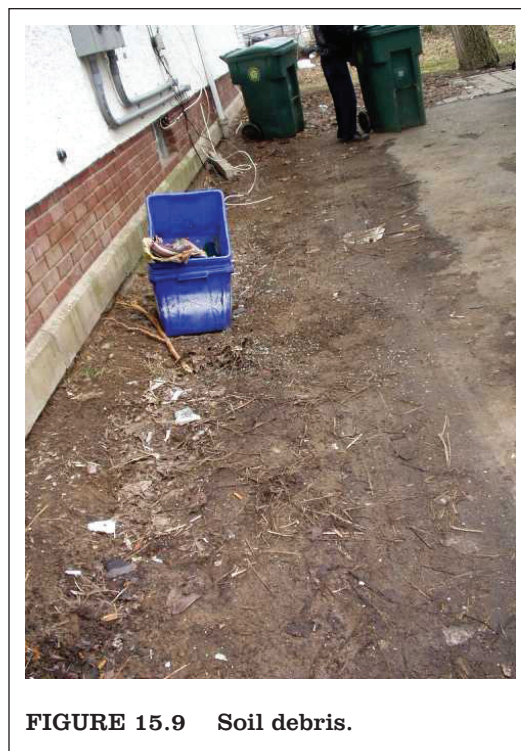


FIGURE 15.9 Soil debris.

Clearance soil sampling is typically conducted around the foundation of the house, although it is also important to collect samples in play areas that could have been contaminated as a result of the work. All soil samples should be composite samples. If only selected faces of the building were treated, the first composite sample's subsamples should come from the soil under those faces, with a second composite soil sample collected from any nearby play areas. In both cases, bare soil should be sampled preferentially. If the exterior work involved covering bare soil areas only, clearance soil samples are not needed; a visual examination is adequate. Protocols for soil sampling are provided in Appendix 13.3 of these *Guidelines*, or ASTM Standard E 1727-05, Standard Practice for Field Collection of Soil Samples for Lead Determination by Atomic Spectrometry Techniques (www.astm.org/Standards/E1727.htm), or the EPA report, *Residential Sampling for Lead: Protocols for Dust and Soil Sampling*, March 1995 (EPA 747R95001) (www.ecy.wa.gov/programs/hwtr/demodebris/pages2/leadsample.html).

Sampling replacement soil, mulch, and other similar material used to replace or cover soil-lead hazards is optional at clearance (see Figure 15.9). EPA soil abatement regulations require that the lead concentration in replacement soil must be no greater than 400 parts per million (ppm; $\mu\text{g/g}$). These *Guidelines* recommend a lead concentration of no greater than 200 ppm, if possible. This lower concentration is required after interim control work in housing covered by HUD's Lead Safe Housing regulation (24 CFR 35.1330(f)(3)(i)(C)), and is recommended by HUD for abatement work in housing covered by its regulation. In a soil abatement activity, the certified abatement supervisor or contractor is responsible for installing replacement soil with acceptable levels of lead. In non-abatement activities, the owner may wish to obtain assurance from the supplier or from the clearance examiner that lead levels are acceptable, but this is generally not necessary for mulch or bark that comes from trees or other vegetation. (Shredded wood from old houses is not recommended because it may be contaminated by lead-based paint.)

If exterior work on lead-based paint has been performed, the contractor, owner, or public agency may wish to document that the work did not contaminate soil surrounding the dwelling. If this optional testing is desired, baseline soil samples (i.e., samples taken before the work began) should have been collected but not necessarily analyzed until clearance soil samples have been collected, analyzed, and compared to clearance standards. Soil samples collected during risk assessments (if one was performed) can be used as baseline samples.

C. Multi-family Housing Properties with more than One Building

If a large multi-building complex (development) of multi-family housing has undergone similar lead hazard control work in several areas of the exterior or soil, random sampling of the soil around the buildings can be conducted using the sampling scheme for lead-based paint inspection (see Chapter 7). Soil should be sampled around each building that: (1) experienced exterior paint-disturbing work; and (2) contains a dwelling unit that would have been randomly selected under the procedure for unit sampling described in Chapter 7. The drawbacks of conducting random clearance sampling are the same for soil as for dust (see Section IV.B.2, above).

As with the single-building case, above, one composite soil sample should be collected around the perimeter of each building. If only selected faces of the building were treated, the samples should come from the soil under those faces. A second composite soil sample should be collected from any nearby play areas. In both cases, bare soil should be sampled preferentially.

VIII. Determining Specified Hazard Control Work was Done (optional)

If the client wishes, the report of the clearance examination may include a determination as to whether lead hazard control work on all interior and exterior surfaces to be treated was in fact done as specified. This option, which is one possible way for the owner to reduce liability, is not part of the standard clearance examination. It is normally the responsibility of the contractor performing the work or the construction manager. If desired by the client, it should be agreed to explicitly in advance. This function should be performed by a certified risk assessor or lead-based paint inspector. Sampling technicians are not trained to make this determination.

To do this, it is strongly recommended that, for most jobs, especially those involving abatement, the clearance examiner observe the work at critical phases, as well as at other times. In any event, it is essential that clearance examiners have full knowledge of the extent of the work, including the original scope and any change orders, and specifically which surfaces did not require treatment. The clearance examiner should have access to any risk assessment or paint inspection reports as well as the job scope of work or specifications and a report from the owner or contractor that the work has been completed. When paint removal and repainting or soil removal and covering are planned, verification of the removal of the lead hazards will be necessary prior to the completion of work.

Regulatory requirements:

- ◆ EPA requirements for abatement: When abatement of lead-based paint hazards is performed, EPA work practice standards require that a certified abatement supervisor be responsible for the job and that the supervisor prepare a report describing the abatement work that has been done and the results of the clearance tests. The owner may wish to ask a risk assessor or lead-based paint inspector to assist in monitoring the project and/or making a finding that the abatement was conducted in accordance with the specifications for the job as well as to perform the normal clearance examination.
- ◆ HUD requirements for interim controls in Federally-assisted housing: If the job is covered by HUD requirements for housing receiving Federal assistance or housing being sold by the Federal Government, HUD's Lead Safe Housing Rule requires that the owner or another designated party prepare a report that describes the hazard reduction or maintenance work that has been performed. In this case, the client may want the clearance examiner to assist in determining that the work is done as planned and to prepare the description of the work, or the client may prepare the description of the work. In either case, the clearance examiner must prepare the report on the results of the clearance examination.
- ◆ Lead-poisoning cases: In the case of a child with an elevated blood-lead level, local or State authorities may require that the treatment of all indicated surfaces be verified by a Government employee or certified third party, especially in cases where the abatement has been ordered by local authorities. In addition, for certain types of HUD housing assistance, HUD's Lead Safe Housing Rule requires environmental interventions when the children's blood lead level is sufficiently high. Clearance examiners should determine if the property they are evaluating has been treated as a result of a legal or regulatory proceeding. If so, the enforcement agency should be contacted to coordinate clearance procedures, prevent duplication of effort and, most important, ensure that the private clearance process is not inadvertently overstepping the bounds of the normal practices of the local health department or childhood lead-poisoning prevention program.

A report on work done should contain the following information:

- ◆ The address or location of the property or structures to which the report applies;
- ◆ The start and completion dates of the work;
- ◆ The name, address, and certification type and number of each firm or organization conducting the work, and the name(s) of supervisor(s) / certified renovator(s) assigned to the work;
- ◆ A detailed written description of the work, including the methods used, locations of exterior surfaces, interior rooms *and common areas*, and/or components where the work occurred, and (if applicable) any suggested monitoring of encapsulants or enclosures; and
- ◆ If soil hazards were controlled, a detailed description of the locations of the work and the methods used.

See Section X, below, for a list of information to be included in a report on the results of a clearance examination.

The following is guidance for determining completion of various types of lead hazard control work.

A. Paint Removal and Repainting

All surfaces where paint has been removed should be visually examined *prior to repainting*. If clearance is conducted after new paint is applied, it is often impossible to determine if the old paint was actually removed. Areas commonly overlooked during paint removal projects include the underside of interior window sills and handrails, backside of radiator ribs, the bottom edge of doors, the top of doorframes, and the back edge of shelving.

For both on-site and off-site paint removal, the clearance examiner or the owner should examine the bare surfaces to ensure that there is no visible residue (see Figure 15.10). If residue remains, the component should be cleaned prior to repainting or refinishing.

Wipe sampling and X-ray fluorescence (XRF) testing are not appropriate tools for determining the effectiveness of paint removal from a particular surface. Wipe sampling cannot dislodge any leaded-dust that may have been absorbed into the substrate during the removal process, nor can it remove paint that is still bonded to the substrate. Wipe sampling is appropriate for measurement of settled leaded-dust on floors, interior window sills, and window troughs. It is not appropriate to apply the settled leaded-dust clearance standard to stripped surfaces prior to repainting because the bare surface will be sealed with new paint, thus rendering the dust inaccessible. Appendix 1 describes how much lead-contaminated dust can remain on a surface (at least 35,000 $\mu\text{g}/\text{ft}^2$) before it would cause the newly applied paint to become lead-based paint (at 0.5 percent).

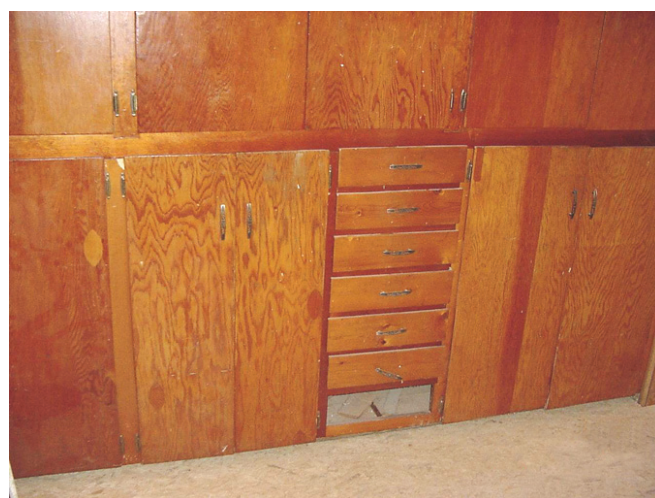


FIGURE 15.10 Surfaces that may have had paint stripped.

XRF testing of surfaces that have been stripped and repainted is not recommended. If the paint has been removed, removal should be assessed visually prior to repainting. Therefore the work specification should require the contractor to request visual clearance before paint or primer is applied. If for some reason it is not possible to visually determine that the paint has been removed, then XRF readings can be taken. The protocols described in Chapter 7 apply.

B. Building Component Removal and Replacement

If building components coated with lead-based paint were removed as a lead hazard control measure, the clearance examiner should have detailed knowledge of the scope of the activities so that actual removal can be verified. Each building component specified for replacement should also be examined to determine if it was overlooked during the lead hazard control work.

C. Enclosures

Complete installation of enclosure systems, such as new drywall, paneling, or siding, can be best evaluated by direct visual observation. The clearance examiner should determine that the mechanical fastening system used to hold the enclosure to the substrate is adequate. This is especially important for ceilings. All seams and edges in the enclosure should be sealed to provide a “dust-tight” (but not necessarily airtight) system (see Chapter 12 for further information on enclosures.)

D. Encapsulants

Another category of lead hazard control that can best be assessed visually is the application of encapsulants. Assuming that the encapsulant was properly selected for the surface undergoing treatment and that patch tests were conducted as recommended in Chapter 13, the clearance examiner can determine if the encapsulant is, in fact, present. Some States have requirements for the composition and/or application of encapsulants used in abatement.

E. Soil Treatments

Soil treatments, which typically consist of some form of covering or removal and/or replacement, can be assessed by visual observation to determine if the covering is present. For example, if sod or asphalt has been used as a soil covering, the clearance examiner should determine if all bare areas have been covered by sod or asphalt, as specified. See guidance on optional soil testing in Section VII, above.

F. Interim Controls

Visual examination of the wide variety of interim control measures consists of a confirmation that all lead-based paint (either suspected or identified through testing) within the scope of work is stabilized, and that any friction, impact, and other surfaces marked for treatment in the risk assessment report or project specifications have all been properly treated. No known or suspected lead-based paint within the scope of work should be in a deteriorated condition in a cleared dwelling or on the building exterior.

IX. Interpretation of Clearance Results, Recleaning, and Resampling

A. Visual Assessment Results

The clearance examiner should follow the procedures for visual assessment recommended in Section V.A, above.

B. Dust Sampling Results

Clearance dust standards are shown in Table 15.2 for single-surface wipe samples. Levels from single-surface wipe samples must be less than these levels to pass clearance. Clearance standards are shown in micrograms per square foot ($\mu\text{g}/\text{ft}^2$, micrograms of lead per square foot of sampled area, the common measurement unit for dust-lead clearance in the U.S.), and their equivalents in milligrams per square meter (mg/m^2 , commonly used outside the U.S.).

Levels from a composite sample must be less than the following: the levels in Table 15.2 divided by one-half of the number of subsamples in the composite. Composite samples with two, three or four subsamples may be collected; the single-sample standards are divided by 1, 1.5 or 2, respectively, to determine the composite-sample standards. Clearance dust standards are shown in Table 15.3 for composite samples, in both $\mu\text{g}/\text{ft}^2$ and mg/m^2 .

C. Recleaning and Resampling

1. Single-Surface Clearance Sampling

If single-surface wipe sample leaded dust levels equal or exceed those shown in Table 15.2, cleaning and sampling must be repeated until compliance is achieved. The clearance examiner should explain to the client exactly what surfaces must be recleaned in what rooms. The recleaning should be focused on those types of surfaces where the sampling results indicate that the previous round of cleaning was inadequate. For example, if floor leaded dust levels are above the standard, but interior window sills and window troughs are below the standard, only the floors need to be recleaned. Similarly, if single-surface samples fail in one room, then only that room and any rooms not sampled need to be recleaned. If composite samples fail, then *all* the surfaces the composite represents need to be recleaned (or resampled individually to determine which ones require recleaning). For example, consider the two examples shown in Tables 15.4 and 15.5.

Table 15.2 Clearance Dust Standards (Single-Surface Wipe Samples).

Surface	Dust-Lead Loadings Must Be Less Than ¹ :	
Bare and carpeted floors	40 $\mu\text{g}/\text{ft}^2$	0.43 mg/m^2
Interior window sills	250 $\mu\text{g}/\text{ft}^2$	2.70 mg/m^2
Window troughs	400 $\mu\text{g}/\text{ft}^2$	4.30 mg/m^2

¹Dust-lead standards are expressed in micrograms per square foot ($\mu\text{g}/\text{ft}^2$). To convert from $\mu\text{g}/\text{ft}^2$ to mg/m^2 , multiply by 0.01076.

In Table 15.4 only the floors in rooms 1 and 2 require recleaning, assuming it is a four-room clearance area. The entire floor of each of these two rooms must be cleaned, not just the sampled spot. If there are unsampled rooms, the entire floors in those rooms would have to be recleaned also, or the floors in those rooms would have to be independently sampled, with any floor recleaning confined to rooms failing clearance. In either case, new floor dust samples would have to be taken to represent the rooms that were recleaned (if more than four rooms are recleaned, samples can be taken in a sample of rooms, as described in Section VI.C, above), and the samples must be analyzed and the results interpreted to determine whether the rooms pass clearance.

2. Composite Clearance Sampling

In Table 15.5, which is based on composite sampling with four subsamples in each composite, the clearance standard is one-half the standard for single-surface sampling; because one-half of 4 is 2, the single-surface sampling standard is divided by 2. Thus the standards applicable to this case are 20 $\mu\text{g}/\text{ft}^2$ for floors, 125 $\mu\text{g}/\text{ft}^2$ for interior window sills, and 200 $\mu\text{g}/\text{ft}^2$ for window troughs. This is shown in Table 15.3.

The floors and window sills are below their respective composite clearance standards, so they pass clearance. The window troughs, with dust-lead levels at 3695 $\mu\text{g}/\text{ft}^2$, is at or above the 200 $\mu\text{g}/\text{ft}^2$ composite clearance standard for four window trough subsamples (specifically, it exceeds the standard). Therefore all the window troughs should be recleaned in all four sampled rooms and any rooms not sampled. While the window troughs could conceivably be sampled individually to determine which ones require recleaning, it is likely to be more cost effective to simply reclean all of them. When cleaning troughs, the interior sills should also be cleaned, even if they were not originally contaminated, to minimize contamination of the sills during cleaning of the troughs.

Recleaning, if necessary, should be performed as soon as possible after receiving dust sampling results because dust lead on failed surfaces can migrate to other surfaces that successfully cleared.

Repeated sampling of the recleaned surfaces should be completed to ensure that the recleaning was sufficiently effective. (The clearance examiner and work supervisor may also want to recheck the completeness of the work.) In the second round of sampling, the clearance examiner should take wipe samples from specific floor, sill, or trough locations that are different from the specific wipe locations used in the initial round of sampling because the initial wipe cleaned the wiped surface. Also, the clearance examiner should consider taking one or more of the second wipe samples in unsampled rooms, if any, unless no work was done in those rooms.

If a surface fails clearance twice, the property owner should consider additional hazard control measures and/or further sealing of the surface prior to a second recleaning and a third round of clearance dust sampling.

Table 15.3 Clearance Dust Standards (Composite Wipe Samples)¹.

Surface / Number of subsamples	Dust-Lead Loadings Must Be Less Than ² :	
Bare and carpeted floors		
2	40 µg/ft ²	0.43 mg/m ²
3	27 µg/ft ²	0.29 mg/m ²
4	20 µg/ft ²	0.22 mg/m ²
Interior window sills		
2	250 µg/ft ²	2.70 mg/m ²
3	167 µg/ft ²	1.79 mg/m ²
4	125 µg/ft ²	1.35 mg/m ²
Window troughs		
2	400 µg/ft ²	4.30 mg/m ²
3	267 µg/ft ²	2.87 mg/m ²
4	200 µg/ft ²	2.15 mg/m ²

¹ The standard for a composite clearance dust sample is determined by dividing the single-surface standards, above, by one-half the number of subsamples in the composite sample. Thus, for a three-subsample composite, half of 3 equals 1.5, so the floor standard is 40 µg/ft² divided by 1.5, which equals 27 µg/ft².

² Dust-lead standards are expressed in micrograms per square foot (µg/ft²). To convert from µg/ft² to mg/m², multiply by 0.01076.

Table 15.4 Hypothetical Example of Single-Surface Clearance Dust Sampling Data.

Room	Floors (µg/ft ²)	Interior Sills (µg/ft ²)	Window Troughs (µg/ft ²)
1	230	50	190
2	375	65	285
3	28	70	214
4	31	40	305

Table 15.5 Hypothetical Example of Composite Clearance Dust Sampling Data.

Surface	Rooms Included in Composite	Leaded Dust (µg/ft ²)
Floors	1,2,3,4	18
Interior window sills	1,2,3,4	120
Window troughs	1,2,3,4	3695

X. Report Preparation

It is essential that the clearance examiner provide the client with a report documenting the results of the clearance. EPA specifies the required contents for an abatement *report* at 40 CFR 745.227(e)(10). HUD specifies the required report contents for *non-abatement projects in units covered by the Lead Safe Housing Rule* at 24 CFR 35.1340(c). A checklist-based worksheet (Form 15.4) covers both requirements.

A. Summary Report

The report should include a one-page summary at the beginning of the report that is suitable for communication with residents, as well as a complete file of the visual assessment(s) form(s) and the dust sampling results form(s). Form 15.3, at the end of this chapter, provides a format for the summary report. The summary should contain the following information:

1. The address of the property where the clearance area is located.
2. A description of the area(s) covered by the clearance examination, including, as applicable, the specific dwelling units or common areas covered by the clearance and the specific rooms and exterior spaces.
3. The name and address of the client.
6. A summary of the results of the visual assessment. (The clearance examination should be stopped if the visual assessment fails.)
7. A summary of the results of the dust testing, which should include either:
 - (a) A statement that no dust-lead hazards, as defined by the relevant EPA, State, Tribal or local standards, were found in the clearance area, and the date of the dust sampling; or
 - (b) A statement that dust-lead hazards were found in the initial examination, identifying the date of the initial examination, the rooms and surfaces where dust-lead hazards were found, including any unsampled rooms and surfaces represented by the samples, and stating the dust-lead levels found.
8. If dust-lead hazards were found in a second or later round of dust sampling, a similar summary of the results of the dust testing should be provided for each round separately.
9. If the initial or later round of sampling found no dust-lead hazards, the report of a successful clearance examination should contain a statement that, based on visual assessment and dust sampling on the specific sampling date, no dust-lead hazards, as defined by the relevant EPA or State, Tribal or local standards, were found.
10. Identification of the clearance examiner(s), including the name of the clearance examiner, the name of the examiner's firm or organization, business address and telephone number, and the examiner's license or certification number.
11. Identification of the laboratory, including the name, address, telephone number, and NLLAP number.
12. The signature of the clearance examiner, with date.

The owner should use the summary of the report for, among other purposes: (1) promptly notifying current residents of the clearance results, as required by the HUD Lead Safe Housing Rule (if the property is covered by that rule), and (2) disclosing clearance dust-lead testing results and other lead reports, records and knowledge to prospective lessees (tenants) and purchasers of the property before they become obligated under a lease or sales contract, as required by Federal law under the HUD-EPA Lead-Based Paint Disclosure Rule (24 CFR 35, subpart A and 40 CFR 745, subpart F). The disclosure rule applies to almost all pre-1978 housing. See Appendix 6 for more information.

B. Regulatory Report Requirements

When abatement is performed, a certified supervisor or project designer must provide an abatement report that follows 40 CFR 745.227(e)(10) if EPA is operating the State or Tribal lead abatement certification program. In a State or Tribal area that has an EPA-authorized lead abatement certification program, the abatement report must follow that program's regulation.

When a non-abatement hazard reduction or maintenance activity requiring a clearance report is performed in housing covered by HUD's Lead Safe Housing Rule, the report must follow 24 CFR 35.1340(c) of that regulation.

Because HUD's report requirements were based on EPA's, the two reports are similar. The common and individual-agency requirements are outlined below; see the regulations for the exact wording of the requirements:

1. (Both) Start and completion dates of the abatement, lead hazard reduction or maintenance work.
2. (Both) The name and address of each certified firm conducting the work, and the name of each supervisor assigned to the project.
3. (HUD) The address of the residential property where the work was done, and, if only part of a multi-family property is affected, the specific dwelling units and common areas affected.
4. (EPA) The occupant protection plan.
5. (Both) The name, address, and signature of the clearance examiner.
6. (Both) The date(s) of clearance examination and testing.
7. (HUD) The results of the visual assessment for the presence of deteriorated paint and visible dust, debris, residue or paint chips.
8. (Both) The results of clearance testing, including the results of the analysis of dust samples, in $\mu\text{g}/\text{sq. ft.}$, by location of sample.
9. (EPA) The results of all soil analyses (if applicable), in parts per million ($\mu\text{g}/\text{g}$), by location of sample.
10. (Both) The name of each NLLAP-recognized laboratory that conducted the analyses.
11. (HUD) The address and NLLAP identification number for each laboratory.
12. (Both) A detailed written description of the work, including the methods used, locations of exterior surfaces, interior rooms, common areas, and/or components where the hazard reduction activity occurred, and any suggested monitoring of encapsulants or enclosures.

13. (HUD) If soil hazards were reduced, a detailed description of the location(s) of the hazard reduction activity and the method(s) used.

Some States, Tribes or localities may have specific requirements or forms pertaining to clearance reports. Clearance examiners must comply with those requirements if they are more stringent or protective than the applicable federal requirements.

XI. Recordkeeping

A. Recordkeeping Responsibilities

Three parties should maintain records of all abatement, interim control, risk assessment, inspection, and clearance results, and resident notifications and disclosure forms, with which they have been involved:

- ◆ Property owner.
- ◆ Contractor.
- ◆ Clearance examiner.

See Section X.A, above, regarding the owner's responsibility for clearance report record retention and disclosure / notification under the Lead Disclosure Rule and, if applicable, the Lead Safe Housing Rule. (See Appendix 6 for more information on record retention, disclosure, and notification.) Some jurisdictions may also require submission of such records to an enforcement agency or a lead-safe housing registry.

B. Record Content

The records should include all laboratory results, quality control/quality assurance procedures, dates of both visual examination and environmental sampling, completed forms, and appropriate identifiers for the property – the owner, inspector, contractor, and resident(s).

C. Length of Retention

Records of all clearance testing should be kept for no less than 3 years but preferably for the duration of the life of the building, since it is to the benefit of the owners to retain this information. See Appendix 6 for more information. Some states require a longer period of record retention of (e.g., New Jersey requires that lead records for multi-family target housing be retained for at least 5 years).

**Form 15.1 Visual Assessment –
Lead Hazard Clearance Examination.**

Property address: _____ Page _____ of _____

Name of client: _____

Name of clearance examiner: _____ Certification No.: _____ Exp. date: _____

Date of visual assessment: ____ / ____ / ____ Repeat visual assessment? Yes No

This form covers: Dwelling units. (Specify which units) _____

Common areas. (Specify which areas) _____

Exterior areas/outbuildings. (Specify) _____

Any deteriorated paint, visible dust, paint chips, or paint-related debris observed? Yes No

If "Yes," record observations in the table below:

Room, Area, or Side of Building (if exterior)	Building Component, or Other Surface (such as ground or vegetation)	Additional Notes on Specific Location	Description of Problem (i.e., deteriorated paint, visible dust, paint chips, or paint-related debris)

Notes (include any explanations by the client of why deteriorated paint has not been repaired; also include any instructions to client regarding further cleaning):

Signature of clearance examiner: _____

Form 15.2 Field Sampling Form for Dust-Lead Hazard Clearance Examination (single-surface sampling).

Property address: _____ Apt. no. or common area: _____ Page _____ of _____

Name of property owner: _____ Name of clearance examiner: _____

Certification #: _____ Exp. date: _____

Sample Number	Room (if possible, use room names used by the owner or resident)	Surface Type (hard floor, carpeted floor, interior window sill, or window trough) ¹	Exact Location of Wipe Sample	Dimensions of Sample Area (inches x inches) ¹	Area of Sample (sq. ft. ²)	Results of Lab Analysis		Pass ³ (less than standard or Fail (equal or greater than st'd.))
						µg of Pb in Sample	µg/ft ²	

¹ Measure to the nearest 1/8th or 1/10th of an inch. [1/8 = 0.125; 2/8 = 0.25; 3/8 = 0.375; 4/8 = 0.5; 5/8 = 0.625; 6/8 = 0.75; 7/8 = 0.875]

² Calculate area in square feet as follows: Calculate square inches, then divide by 144.

³ EPA standard: 40 µg/sq. ft. for floors; 250 µg/sq. ft. for interior window sills; and 400 µg/sq. ft. for window troughs.

Total number of samples on this page: _____ Date of sample collection: _____/_____/_____ Date shipped to lab: _____/_____/_____

Shipped by: _____ (signature) Received by: _____ (signature and date) Reviewed by: _____ (signature and date)

Date results reported by lab: _____/_____/_____ Reviewed by: _____

Form 15.3 Lead Hazard Clearance Report – Completed Example

The following report is a made-up example of a clearance report from a small , non-abatement, rehabilitation job (less than \$5,000) that involved window replacements in the small bedroom and kitchen of a single-family home that is available for rent. The clearance report covers clearance of the worksite.

Home Environmental Inspection Services, Inc.

345 Hammond Road
 East Chicago, IN 12345
 123-123-1235
 345-789-5678 (fax)

Firm certification number: IN 78787

Clearance Report

General Information

Date of clearance examination:	8/5/2010
Clearance Examiner:	Joe Smith
Certification Category:	Risk Assessor
Certification Number:	IN 77777
Property address:	78 East Main St., Apt. A Hammond, IN 89898
Client name:	Sally Jones
Client address:	80 East Main St. Hammond, IN 89898
Laboratory:	Analysis Services, Inc.
Address:	990 45 th St., Suite 500 Gary, IN 44444
Telephone number:	222-222-2222
NLLAP number:	IN 999999

Summary of Clearance Results

Dust above Federal standards was found in the following areas:

Location	Surface	Fg lead/ft ²
Small bedroom	Side facing window (C-1) – windowsill	600
Small bedroom	Floor	200
Kitchen	Window above sink (A-1) – windowsill	525

Signature: Joe Smith

Date: 8/6/2010

Summary of Hazard Reduction Activities

Name of firm	ABC Renovations
Address of Firm	123 Main Street East Chicago, IN 12345
Abatement or RRP Firm Certification Number	IN45789
Name of Certified Abatement Supervisor / Certified Renovator	John Brown #1634
Supervisor / Renovator Certification Number	IN1634
Start and completion date of hazard reduction or abatement activity.	8/1/2010 to 8/5/2010

Description of Hazard Reduction Activities and Areas Addressed:

Location	Activity
Kitchen	Replaced A-1 window with new, vinyl-clad window
2nd Floor Small Bedroom	Replaced C-1 and C-2 windows with new, vinyl-clad windows
Description of Work	The certified renovator was present on the job site when work was being performed. Workers used lead-safe work practices. Plastic sheeting covered a 8-foot area on the ground outside under the windows being replaced and on the floor inside. Signs were posted at the doors to the bedroom and kitchen. Occupants were not allowed in the kitchen and bedroom and the outside work area during this activity. The window frame was misted prior to tear-out. After removal, workers wrapped the old windows in plastic sheeting and picked up debris on the plastic immediately and bagged it. The plastic sheeting was carefully gathered up and bagged for disposal. Workers replaced their disposable booties when leaving the work area for lunch and breaks. Respirators were not necessary. The new windows were installed and, in accordance with the contract, a clearance examination was requested.

On-Going Lead-Based Paint Monitoring Requirements:

HOME rental assistance is not provided to this unit, so ongoing LBP maintenance is not required.

VISUAL EVALUATION RESULTS FORM

Date of clearance:	8/5/2010
Clearance Technician:	Joe Smith
Client:	Sally Jones
Property address:	78 East Main St., Apt. A Hammond, IN 89898

Visual Assessment of the Work Area

Work Area	Deteriorated Paint	Debris	Visible Dust	Notes	Pass/Fail
Small bedroom					Pass
Kitchen					Pass
First floor hallway					Pass
Staircase					Pass
Second floor hallway					Pass
Exterior soil under kitchen window					Pass
Exterior soil under bedroom window					Pass

DUST SAMPLING RESULTS FORM

Date of clearance:	8/5/2010
Clearance Technician:	Joe Smith
Client:	Sally Jones
Property address:	78 East Main St., Apt. A Hammond, IN 89898

Sample #	Location	Surface	Dimensions of sample area	µg Lead/ft ²	Pass/Fail
1-2	Upstairs small bedroom	Front facing window (C-2)- windowsill	4" x 18"	17	Pass
1-3	Upstairs small bedroom	Floor under C-1 window	12" x 12"	200	Fail
1-4	Upstairs small bedroom	Side facing window (C-1)- windowsill	4" x 18"	600	Fail
2-1	Second floor	Floor	12" x 12"	35	Pass
3-1	Staircase	Floor	12" x 12"	30	Pass
4-1	Kitchen	Floor under A-1 window	12" x 12"	12	Pass
4-2	Kitchen	Window above sink (A-1)- windowsill	4" x 18"	525	Fail
5-1	First floor	Floor	12" x 12"	30	Pass

Understanding Your Report

1. The Summary Results section lists all of the areas that failed the clearance examination. The areas represented by the sample needs to be re-cleaned and re-tested to see if the cleaning removed the contaminated dust. Deteriorated painted surfaces should be repaired using interim controls or abatement techniques.

For written information on how to address lead hazards, call the National Lead Information Center Clearinghouse at 1-800-424-Lead (1-800-424-5323). You may consider hiring a risk assessor to evaluate lead hazards in your home and recommend a lead hazard control plan. Risk assessors may be found from the EPA Regional Lead Coordinator, if the property is in a State for which EPA operates the lead certification program, through www.epa.gov/lead/pubs/leadoff1.htm, or if the property is in a State or Tribal Area which does operate the lead certification program, through www.epa.gov/lead/pubs/traincert.htm.

2. The laboratory result forms attached to the report list all of the areas sampled inside and outside the dwelling and the laboratory analysis results for each sample.
3. The dust sampling results are expressed in micrograms per square foot ($\mu\text{g}/\text{ft}^2$); soil samples are expressed in micrograms per gram ($\mu\text{g}/\text{g}$).
4. Areas that failed the clearance examination showed lead levels in dust at or above Federal or state standards. The standards that were used for during this clearance examination are:

HUD/EPA Clearance Standards for Lead in Dust

Carpeted and Uncarpeted Floors: $40 \mu\text{g}/\text{ft}^2$

Interior window sill (stool): $250 \mu\text{g}/\text{ft}^2$

Window trough: $400 \mu\text{g}/\text{ft}^2$

Form 15.4 Clearance Report Review Worksheet

You may use the worksheet for a project that requires clearance, or when the owner chooses to have clearance, to document clearance was achieved and the clearance report is complete.

Property Address: _____ Date: _____
 Name of Reviewer: _____ Title: _____

Question	Yes	No	Notes
<i>The clearance examiner's report must include the information in items number 1 through 6, and 13a. See below on instructions for Items 7-12. Item 12 may be required.</i>			
1. Property address and specific unit or common areas identified.			
2. Name, address, signature and certification number of each person involved in the clearance examinations.			
3. Name and NLLAP identification number of each laboratory conducting an analysis.			
4. Dates of clearance examination.			
5. Results of visual assessment for the presence of deteriorated paint and visible dust, debris, residue or paint chips.			
6. Results of all analyses (dust wipes in micrograms per square feet (µg/ft ²); soil in parts per million) by location of sample, as well as information about the laboratory.			
<i>The clearance report must also include information on lead hazard reduction (Items 7-11). Indicate the source of the information (the designated party or contractor may have to provide this information) if the clearance examiner was not responsible for the information. Item 12 is required for abatement and optional for other projects.</i>			
7. Name and address of each firm and supervisor involved in the lead hazard reduction activity.			
8. Start and completion dates of lead hazard reduction activity.			
9. Detailed <i>written</i> description of the lead hazard reduction activity, including the methods used.			
10. Locations of exterior surfaces, interior rooms, common areas and/or components where the hazard reduction activity occurred.			
11. Any suggested monitoring requirements. (If none, enter "N/A".)			
12. Occupant protection plan (<i>required for abatement</i> project, optional otherwise; if not required or done, enter "N/A").			
<i>Evaluate the results of the report.</i>			
13. Did each unit or common area pass clearance?			

Other Notes:

Form 15.5 Example of Filled-In Clearance Report Review Worksheet

You may use the worksheet for a project that requires clearance, or when the owner chooses to have clearance, to document clearance was achieved and the clearance report is complete.

Property Address: 78 East Main St., Apt. A, Hammond, IN 89898 Date: 8/8/2010

Name of Reviewer: John Jones Title: Construction Specialist, City of Hammond, IN

Question	Yes	No	Notes
<i>The clearance examiner's report must include the information in items number 1 through 6, and 13a. See below on instructions for Items 7-12. Item 12 may be required.</i>			
1. Property address and specific unit or common areas identified.	x		
2. Name, address, signature and certification number of each person involved in the clearance examinations.	x		
3. Name and identification number of each laboratory conducting an analysis.	x		
4. Dates of clearance examination.	x		
5. Results of visual assessment for the presence of deteriorated paint and visible dust, debris, residue or paint chips.	x		
6. Results of all analyses (dust wipes in micrograms per square feet (µg/ft ²); soil in parts per million) by location of sample, as well as information about the laboratory.	x		
<i>The clearance report must also include information on lead hazard reduction (Items 7-11). Indicate the source of the information (the designated party or contractor may have to provide this information) if the clearance examiner was not responsible for the information. Item 12 is required for abatement and optional for other projects.</i>			
7. Name and address of each firm and supervisor involved in the lead hazard reduction activity.	x		
8. Start and completion dates of lead hazard reduction activity.	x		
9. Detailed written description of the lead hazard reduction activity, including the methods used.	x		
10. Locations of exterior surfaces, interior rooms, common areas and/or components where the hazard reduction activity occurred.	x		
11. Any suggested monitoring requirements. (If none, enter "N/A".)	N/A		
12. Occupant protection plan (required for abatement project, optional otherwise; if not required or done, enter "N/A").	N/A		
<i>Evaluate the results of the report.</i>			
13. Did each unit or common area pass clearance?	x		

Other Notes:

HOME rental assistance is not provided to this unit, so ongoing LBP maintenance is not required.

References

- Ashley, 2001. Ashley, K., Wise, T.J., Mercado, W., Parry D.B., Ultrasonic extraction and field-portable anodic stripping voltammetric measurement of lead in dust wipe sample. *Journal of Hazardous Materials*, 83: 41-50, 2001.
- ATSDR, 1988. Agency for Toxic Substances and Disease Registry, U.S. Department of Health and Human Services, *The Nature and Extent of Lead Poisoning in Children in the United States: A Report to Congress*, Atlanta, Georgia.
- Battelle, 2002. Battelle Memorial Institute, "A Field Study Comparing the Use of Individual and Composite Dust-Wipe Samples for Risk Assessment and Clearance Testing," report prepared for the U.S. Department of Housing and Urban Development, Office of Healthy Homes and Lead Hazard Control.
- Binstock, 2009. Binstock, D.A.; Gutknecht, W.F. McWilliams, A.C. "Lead in Soil - An Examination of Paired XRF Analysis Performed in the Field and Laboratory ICP-AES Results," *International Journal of Soil, Sediment and Water*. 2:2(1), 2009. <http://scholarworks.umass.edu/intljssw/vol2/iss2/>
- Choe, 2000. Choe K.T., Trunov, M., Grinshpun, S.A., Willeke, K., Harney, J., Trakumas, S., Mainelis, G., Bornschein, R., Clark, S., and Friedman, W., "Particle Settling After Lead-Based Paint Abatement Work and Clearance Waiting Period," *American Industrial Hygiene Association Journal*. 61:798-807.
- Clark, 2002. Clark, C.S., "Development of a Rapid On-Site Method for the Analysis of Dust Wipes Using Field Portable X-Ray Fluorescence," prepared for the U.S. Department of Housing and Urban Development, January 2002.
- Cox, 2011. Cox, D.C., F.G. Dewalt, K.T. White, R. Schmehl, W. Friedman, and E.A. Pinzer. "Improving the Confidence Level in Lead Clearance Examination Results through Modifications to Dust Sampling Protocols." ASTM International. Special Technical Publication STP1533-EB, January 2011. http://www.astm.org/digital_library/stp/pages/STP49746S.htm. DOI: 10.1520/STP49746S. http://www.astm.org/digital_library/journals/JAI/pages/JAI103469.htm.
- EPA, 1995a. U.S. Environmental Protection Agency, *Residential Sampling for Lead: Protocols for Dust and Soil Sampling*, March 1995 (EPA 747-R-95-001).
- EPA, 2001b. U.S. Environmental Protection Agency, *Analysis of Lead Clearance Testing*, (EPA 747-R-01-005). Office of Pollution Prevention and Toxics, EPA, Washington, DC.
- EPA, 2001. U.S. Environmental Protection Agency, *Analysis of Lead Clearance Testing*. EPA 747-R-01-005. Office of Pollution Prevention and Toxics, EPA, Washington, DC.
- EPA, 2002a. U.S. Environmental Protection Agency, "Questions & Answers About ETV Reports on Portable Technologies for Measuring Lead in Dust," Office of Pollution Prevention and Toxics, EPA, Washington, DC. December 2002.
- EPA, 2002b. U.S. Environmental Protection Agency, The Environmental Technology Verification Program (ETV), Verification Statements EPA-VS-SCM-50, 51, 52, 53, and 54. Prepared by Oak Ridge National Laboratory, Tennessee, August 2002.

EPA, 2004. U.S. Environmental Protection Agency, X-ray Fluorescence (XRF) Instruments. Frequently Asked Questions (FAQ). <http://epa.gov/superfund/lead/products/xrffaq.pdf>

Harper, 2002. Harper M, Hallmark TS, Bartolucci AA. A comparison of methods and materials for the analysis of leaded wipes. *J. Environmental Monitoring*, 4(6):1025-33, December 2002. <http://pubs.rsc.org/en/Content/ArticleLanding/2002/EM/b208456m>

Farfel, 1992. Farfel, M., Paper presented at Centers for Disease Control Conference, December 8, 1992 (unpublished).

HUD, 1991. U.S. Department of Housing and Urban Development, *The HUD Lead-Based Paint Abatement Demonstration (Federal Housing Administration)*, prepared by Dewberry & Davis, HC-5831, Washington, DC.

Jacobs, 1993a. Jacobs, D.E., "Lead-Based Paint Abatement in Murphy Homes," Georgia Institute of Technology Report for the Macon Housing Authority, Macon, Georgia, (unpublished data).

Jacobs, 1993c. Jacobs, D.E., "Analysis of Recovery Rates for Spiked Composite Wipe Samples by the Wisconsin Occupational Health Laboratory and Azimuth Laboratory," National Center for Lead-Safe Housing, Columbia, Maryland (unpublished data).

Lanphear, 1994. Lanphear, B., et al., *The Relation of Lead Contaminated House Dust and Blood Lead Level Among Urban Children*, Final Report to the National Center for Lead-Safe Housing.

Mamane, 1994. Mamane, Y., R. Willis, R. Stevens, R. Miller, and K. Blume, "Scanning Electron Microscopy/X-Ray Fluorescence Characterization of Post Abatement Dust," *Lead in Paint, Soil and Dust: Health Risks, Exposure Studies, Control Measures, Measurement Methods, and Quality Assurance*, ASTM STP 1226, eds.

NCHH, 2002. National Center for Healthy Housing, "An Evaluation of the Efficacy of the Lead-Hazard Reduction Treatments Prescribed in Maryland Environmental Article 6-8," report submitted to Baltimore City Healthy Start, Inc., and Baltimore City Health Department, Lead Abatement Action Program, January 24, 2002.

NCHH, 2004. National Center for Healthy Housing, and University of Cincinnati Department of Environmental Health, *Evaluation of the HUD Lead-Based Paint Hazard Control Grant Program: Final Report*, prepared for the U.S. Department of Housing and Urban Development, Washington, DC, May 1, 2004.

NIOSH, 1993b. National Institute for Occupational Safety and Health, and Ashley, K., J.D. Travis, M. Milson, P.M. Eller, and A.L. Sussell, *Evaluation of Field Methods for Lead Screening and Analysis*, Paper presented at American Industrial Hygiene Association Conference, New Orleans, Louisiana, May 17, 1993.

Olishifsky, 1983. Olishifsky, J. *Fundamentals of Industrial Hygiene*, National Safety Council, Chicago, Illinois.

Sterling, 2000. Sterling DA, Lewis RD, Luke DA, Shadel BN. A portable x-ray fluorescence instrument for analyzing dust wipe samples for lead: evaluation with field samples. *Environmental Research*, 83(2):174-9, June 2000. <http://www.sciencedirect.com/science/article/pii/S0013935100940581>

White, 2011. White K.T., F.G. Dewalt, D.C. Cox, R. Schmehl, W. Friedman, and E.A. Pinzer. "Development of Two Sample Preparation Methods for Determination of Lead in Composite Dust Wipe Samples." *Journal of ASTM International*, Vol. 8, No. 3, http://www.astm.org/DIGITAL_LIBRARY/JOURNALS/JAI/PAGES/JAI103466.htm. DOI: 10.1520/JAI103466.

Chapter 16: Investigation And Treatment Of Dwellings That House Children With Elevated Blood Lead Levels

HOW TO DO IT	16-3
I. Introduction.....	16-5
II. Management of Lead Hazards in the Environment of Individual Children	16-7
A. Public Health Case Management.....	16-7
B. Environmental Investigation and Intervention	16-8
C. State/Local Housing Intervention.....	16-11
III. Lead Hazard Identification	16-11
IV. Lead Hazard Reduction	16-15
A. Time Limits	16-15
B. Modifications to Ordinary Lead-Based Paint Hazard Controls.....	16-15
C. Elimination or Control of Other Lead Hazards	16-16
REFERENCES.....	16-22
FIGURES	
Figure 16.1 Health Department case managers work with parents and guardians of lead-poisoned children.....	16-6
Figure 16.2 Environmental investigations include sites where the child spends time	16-8
FORM	
Form 16.1 Resident Questionnaire for Investigation of Children with Elevated Blood Lead Levels (EBL).....	16-23
TABLES	
Table 16.1 Summary of Recommendations for Assessment and Remediation of Residential Lead Exposure	16-10
Table 16.2 Guidelines for Questions to Ask Regarding a Child’s Environmental History.....	16-12
Table 16.3 Common Sources of Lead Exposure to Consider in an Environmental Investigation	16-13
Table 16.4 Published Reports of Less Common Causes of Elevated Blood Lead Levels (EBLs) in Children.....	16-16



Intentionally Left Blank

Chapter 16: Investigation And Treatment Of Dwellings That House Children With Elevated Blood Lead Levels

How to Do It

1. Identify children with “elevated blood lead levels” (EBL) and, in particular, those children with blood levels considered by applicable statutes or regulations as “environmental intervention blood lead levels” (EIBLL).
 - ◆ **EBL:** Develop a mechanism whereby children under age 6 years with blood lead levels (BLLs) at or above the Centers for Disease Control and Prevention’s (CDC’s) “blood lead reference value” for children under age 6 years are identified. As of the publication of this edition of these *Guidelines*, this reference value is 5.0 micrograms of lead per deciliter of blood (5.0 µg/dL), taken from a venous sample (i.e., from a vein) with the testing result having been verified by confirmatory testing. A child’s BLL can be determined through local health departments, local childhood lead-poisoning prevention programs, or other health care providers. If the child’s BLL is above the reference value, refer the findings to the child’s parents or guardians. Coordinate with the child’s parents or guardians and the appropriate public health, environmental, and housing agencies to avoid duplication of efforts and to determine how the investigation (inspection) should best be conducted.
 - ◆ **EIBLL:** Where a statute or regulation (such as HUD’s Lead Safe Housing Rule (LSHR) as of the publication of this edition of these *Guidelines*) requires action at higher BLLs than EBL, develop a mechanism whereby such children are identified. In particular, under the LSHR, the mechanism should ensure that children under age 6 years with an environmental intervention blood lead level (EIBLL), that is, with a confirmed venous blood lead level at or above 20 µg/dL in a single test, or at 15-19 µg/dL in two tests taken at least three months apart, are identified. Blood lead levels can be determined through local health departments, local childhood lead-poisoning prevention programs, or other health care providers. If the child’s BLL is an EIBLL, refer the findings to the child’s parents or guardians. (If the child’s BLL is at or above 45 µg/dL, the referral should note that CDC states that the response includes evaluation and treatment requiring chelation.) If the child is living in publicly owned or subsidized housing, also refer the findings to the housing agency or other housing assistance provider, and ensure that further medical treatment or case management is undertaken by the responsible authorities. Coordinate with the child’s parents or guardians and the appropriate public health, environmental, and housing agencies to avoid duplication of efforts and to determine how the investigation (inspection) should best be conducted.

2. **Review any assessments.** Review the findings of any risk assessment or reevaluation (Chapter 5) or lead-based paint inspection (Chapter 7) that has already been completed for the property. The protocols in Chapters 5 and 7 usually are not sufficient for use in dwellings with a lead-poisoned child because additional environmental testing and interviewing are often required.
3. **Interview family of the child with an EBL.** Conduct a comprehensive interview based on the CDC checklist (Table 16.2) or use the questionnaire in this chapter (Form 16.1 at the end of the chapter) or an equivalent questionnaire. If a clear lead hazard is identified, correct the hazard within the applicable regulatory or guidance timeframe. If necessary, conduct environmental sampling to confirm the presence of the hazard.
4. **Conduct a full risk assessment.** Whether or not a clear lead hazard is identified, conduct a full risk assessment of the child's dwelling and of any other dwelling or space (e.g., child care center) in which the child spends a significant amount of time, because the identified lead hazard may not be the only one to which the child is exposed. Follow the guidance in Chapter 5 as augmented by the protocol in this chapter. In consultation with the child's case manager, determine what, if any, other possible sources of exposure should be investigated, including:
 - ◆ First-flush drinking water.
 - ◆ Glazed pottery or tableware that may contain lead glazes.
 - ◆ Work clothes or vehicle that may have been contaminated from a parent's or guardian's work place.
 - ◆ Imported cosmetics, hobbies, and folk remedies.
5. **When lead hazard control measures are conducted, relocate child with EBL.** In cases where lead hazard control measures are ordered, relocate the child to a lead-safe environment until the work is completed and clearance is achieved, and coordinate follow-up with the local health department and child's case manager. Prior to the remedial lead hazard control work, ensure that temporary lead hazard control measures, including cleaning, are taken immediately to protect the child living in the dwelling unit.
6. **Conduct clearance examination.** Use the guidance in Chapter 15.
7. **Permit reoccupancy when property is cleared.** Permit re-occupancy when results of clearance testing are acceptable, that is, when the work passes clearance (see Chapter 15).
8. **Provide copies of assessment to caseworker and family.** Copies of the augmented assessment results should be provided to the case manager and to the family of the child with EBL. A copy of the environmental assessment and clearance testing results should be provided to the owner of any rental property. Include recommendations to minimize exposures in the future – e.g. diet, frequent hand and toy washing, frequent floor cleaning, avoidance of cosmetics and other products that have high lead levels, etc.

I. Introduction

This chapter provides a method for investigating the possible causes of lead poisoning for an individual child under age 6 years. Although lead-based paint and lead-contaminated dust and soil are the causes of most lead exposure in American children, another lead source may be the principal cause for a specific instance of lead poisoning or contribute to the blood lead elevation (secondary source). The methods and descriptions contained in this chapter are consistent with those recommended by the Centers for Disease Control and Prevention (CDC) (CDC, 2002) with modifications to reflect the early evolution of the recommendations based on the 2012 CDC Response to Advisory Committee on Childhood Lead Poisoning Prevention Recommendations in “Low Level Lead Exposure Harms Children: A Renewed Call of Primary Prevention” (CDC, 2012a); available at http://www.cdc.gov/nceh/lead/ACCLPP/CDC_Response_Lead_Exposure_Recs.pdf. The Advisory Committee’s report itself (CDC ACCLPP, 2012) is available at the Recommendations of the Advisory Committee for Childhood Lead Poisoning Prevention link, http://www.cdc.gov/nceh/lead/ACCLPP/Final_Document_030712.pdf, on the CDC’s Advisory Committee On Childhood Lead Poisoning Prevention (ACCLPP) page, http://www.cdc.gov/nceh/lead/ACCLPP/acclpp_main.htm.

Because CDC, HUD, and other agencies are expected to continue to develop guidance, outreach documents and other materials pertaining to identifying and responding to children with EBL, the CDC’s Lead website (<http://www.cdc.gov/nceh/lead/>), the HUD lead and healthy homes website (<http://www.hud.gov/offices/lead>), and the lead websites of additional federal and applicable state, tribal and local agencies, should be checked regularly for updates.

As of the publication of this edition of these *Guidelines*, HUD’s Lead Safe Housing Rule (LSHR, 24 CFR part 35, subparts B through R), requires specific actions in certain pre-1978 (“target”) housing receiving federal assistance when a child living there is found to have an environmental intervention blood lead level (EIBLL), that is, a blood lead level at or above 20 µg/dL in a single test, or at 15-19 µg/dL in two tests taken at least three months apart (24 CFR 35.110). The actions to be taken are specified in the Rule in its subparts, which are organized around the types of housing assistance:

Subpart D, Project-Based Assistance Provided by a Federal Agency
Other Than HUD;

Subpart G, Multi-family Mortgage Insurance;

Subpart H, Project-Based Rental Assistance;

Subpart L, Public Housing Programs; and

Subpart M, Tenant-Based Rental Assistance
(also known as the housing choice voucher program).

The LSHR is at HUD’s Lead-Safe Housing Rule web page, <http://www.hud.gov/offices/lead/enforcement/lshr.cfm>, with a link to HUD’s Interpretive Guidance about the rule, which is posted at http://portal.hud.gov/hudportal/documents/huddoc?id=DOC_25476.pdf. See Appendix 6 for more information about the LSHR.

The protocol in this chapter is different from the risk assessment protocol in Chapter 5 of these *Guidelines*. That protocol is meant for use in dwellings regardless of a resident child's blood lead level, as a "primary prevention" measure. Primary prevention is the process of preventing lead hazards from occurring and, when they do occur, controlling lead hazards to prevent exposure before a child is poisoned. The protocol in this chapter is intended for use as part of "secondary prevention," the process of identifying children who have elevated blood lead levels, and controlling or eliminating the sources of further exposure. In particular, secondary prevention involves medical and environmental follow-up services for individual children with an EBL. However, many of the basic procedures and sampling methods are similar between primary and secondary prevention. The investigations of dwellings that house children with EBLs differ from ordinary risk assessments in the following three important ways:

1. The purpose of the investigation is to identify lead hazards in the environment of a child. A ordinary risk assessment attempts to uncover lead-based paint hazards in a dwelling, regardless of whether a child has an EBL.
2. The investigator is obligated to conduct a comprehensive investigation of all sources of lead in the child's environment, not just those lead exposures directly related to the child's residence. This investigation includes studying less-common sources of lead, such as glazed pottery and folk medicines or remedies, etc., and other dwellings or areas frequented by the child. Some of these sources may be discovered by the results of the questionnaire.
3. The investigator tests deteriorated paint on furniture identified as a potential hazard to the environmental intervention blood lead (EIBLL) child, regardless of who owns the furniture.

Many activities described in this chapter are generally performed by State or local health departments and childhood lead poisoning prevention programs, which bear the principal responsibility for responding to individual cases (see Figure 16.1).

However, situations may occur when State or local public health authorities, or parents or guardians hire private risk assessors or investigators to investigate the dwelling of a child with an elevated blood lead level. Some of these agencies can only respond to the children with blood lead levels higher than the EBL threshold, for any of several reasons, leaving cases of children below their action threshold for others to investigate. In addition, some jurisdictions may not have programs available to investigate children with EBL. Medicaid and other third-party payers may reimburse expenses for investigations performed by certified, private-sector investigators.

Investigators who gather the information needed to characterize possible hazards in dwellings that house children with EBL should possess good interviewing techniques as well as proficiency in risk assessment and environmental sampling techniques.



FIGURE 16.1 Health Department case managers work with parents and guardians of lead-poisoned children.

Private individuals who respond to lead poisoned children should always coordinate their activities with local authorities, including public health case managers, public health environmental investigators, housing agencies, and health care providers to prevent unnecessary duplication of effort and to acquire information on sources of lead poisoning that may be significant in a specific locale or culture. In some instances, risk assessments or lead-based paint inspections may have already been completed. Before eliminating paint or dust as the cause of the poisoning, the investigator should carefully review any previous reports to assess the quality of the previous investigations and to ensure that dust test results are a reflection of the current exposure.

Investigators are sometimes asked to explain the meaning of a particular blood lead level. For a specific child, this interpretation is best left to the child's pediatric health care provider or public health case manager. States and local health departments may also provide the basic information to parents or guardians.

II. Management of Lead Hazards in the Environment of Individual Children

The investigation of lead poisoned children is a complex issue requiring teamwork. Three governmental entities are most likely involved: public health, environmental health, and housing agencies.

A. Public Health Case Management

Public health case management consists of coordinating, providing, and overseeing services to reduce children's blood lead levels below the CDC blood lead reference level (as of the publication of this edition of these *Guidelines*, 5.0 µg/dL), and to control or eliminate lead hazards in the child's environment. Case managers are trained public health professionals, including public health nurses, social workers, and public health investigators. Case management includes ensuring prompt and effective environmental management, monitoring medical care, providing education to the family, and coordinating any needed services following an individual plan of care.

Medical follow-up includes repeated blood lead level testing, development assessment, and iron therapy and chelation treatment as indicated. CDC's scheduling recommendations include schedules for obtaining a confirmatory venous sample, and for follow-up blood lead testing (CDC ACCLPP, 2012, tables 2 and 3, respectively).

Families should be educated about lead poisoning, including the meaning of the child's blood lead level and the potential effects of lead on their child, the medical and environmental follow-up planned, how to reduce risks, and how to help their child get well. Environmental investigation and intervention are essential. Some families will need extensive case management and referral to social service providers. The public health case manager is the primary point of contact between the childhood lead poisoning prevention program and the family.

B. Environmental Investigation and Intervention

Environmental investigation and intervention for children with EBL are usually overseen by agencies and programs with legal responsibility for the protection of human health in the dwelling environment, typically local and State health departments. Responsibilities may be shared by public health, environmental, and housing agencies. Public health or environmental agencies may have the responsibility, technical equipment, and expertise for the investigation, but housing agencies may have to enforce the codes or laws. For children with EBL, both a thorough environmental investigation of all possible sources of lead exposure for the individual child and intervention are needed to protect the child from further exposure and harm. Lead-based paint or the lead-contaminated dust and soil may or may not be the main source of the child's exposure to lead. The risk assessor should talk with the public health authorities and improve the communication with the family in order to collect accurate information about the child's exposure, and to ensure the success of any needed intervention.

The environmental investigation should be performed during a visit to the child's current dwelling unit and other sites where the child spends a significant amount of time (e.g., child care center or grandparent's home).

Information about year of construction should be obtained from tax assessor records or other city housing records. The parents or guardians should be questioned regarding all possible lead sources and risk factors. CDC developed guidelines for questioning parents or guardians (see Table 16.2). A detailed questionnaire is set forth in Form 16.1 for use by investigators. Information on child or family member behavioral risk factors, including hand to mouth or toy-to mouth activity, pica (abnormal appetite or craving of non-nutritive substances or non-food items), or parents' or guardians' occupation and the determination that such behaviors are affecting a child's blood lead level is best left to a medical health care provider. If the child has recently moved, the child's blood lead level may reflect exposure to lead hazards at the previous residence. When primary and other locations are identified (such as present and previous dwelling unit and/or child care center, whether in a commercial building or in a home), all of the locations should be investigated. Testing a previous residence or a child care center has the additional benefit that it may also identify lead hazards that could harm other young children currently living in that dwelling.

If assessment of additional dwelling units or a child care center/dwelling is required, the investigator should make the necessary arrangements for assessment and possible testing at these locations after consultation with the child's case manager or local health department (see Figure 16.2).

Testing should include the following at a minimum: house dust, paint/coatings that are not intact or subject to friction, and bare soil, especially in play areas. Testing of drinking water should be done only if: the community drinking water is known to be at risk; the family's home is served by a private well; history suggests contamination; or no other sources of lead can be found. Public health authorities can provide this information.



FIGURE 16.2 Environmental investigations include sites where the child spends time.

Where the questionnaire results indicate that the child may have been exposed to other sources of lead, including toys, children's jewelry, folk or "home" remedies, imported cosmetics, candy or candy wrappers (the Consumer Product Safety Commission has information on many such consumer products, see <http://www.cpsc.gov>), or each parent's or guardian's occupation and hobbies, additional environmental testing may be required. The environmental investigator should consult with the child's case manager or local health department about sampling to identify whether lead hazards are present. Once the assessment of all possible sources of lead exposure has been completed, the most probable source(s) of the child's poisoning can be identified and remedial actions to eliminate further lead exposure of the child can be recommended. The investigator should identify the likely sources of lead exposure to the child's family during the investigation. The investigator should always recommend temporary measures to immediately reduce the child's exposure to lead hazards including a thorough cleaning of the dwelling unit and the placement of temporary barriers over areas with peeling, chipping paint (see Chapter 11). Where probable sources of poisoning are not related to a building (e.g., use of ceramics or folk remedies), follow-up should be referred to the public health team.

The results of the investigation should be released only to parents or guardians, and appropriate government authorities. Confidential information about the child or family should not be revealed to any other individual without the informed consent of the child's parents or guardians. Information concerning building and site hazards, and options for control of those hazards should be reported to both the owner and/or occupant.

If legal action is necessary, public health authorities should determine (based on Federal, State and local law) the nature and extent of requirements for the property. In some cases, the appropriate response may be to help the family move the poisoned child into a lead-safe dwelling unit.

Table 16.1 Summary of Recommendations for Assessment and Remediation of Residential Lead Exposure

1. Conduct an environmental investigation for all children under age 6 years with confirmed blood lead levels greater than or equal to the CDC blood lead reference value (as of 2012, 5.0 µg/dL). This investigation should include:
 - a. An inspection of the child's home and other sites where the child spends significant amounts of time.
 - b. A history of the child's exposure
 - c. Measurements of environmental lead levels, including at a minimum:
 - i. House dust.
 - ii. Paint that is not intact or is subject to friction.
 - iii. Exposed soil, especially in play areas.
 - iv. Other media as appropriate.
2. Ensure that interventions to reduce ongoing exposure:
 - a. Focus on control of current lead hazards.
 - b. Include prompt initial measures (e.g., house dust control by professional cleaners) where appropriate, to reduce lead exposure rapidly.
 - c. Use lead-safe practices by trained workers to avoid increasing lead exposure to occupants and workers. If the interventions include renovation, repair or painting (RRP) work that is not covered by EPA's minor repair and maintenance exemption from the EPA's RRP Rule, the work must be conducted by a certified renovation firm using a certified renovator conducting or supervising the work, and, if used, all additional workers must be trained to work in a lead-safe manner on the job.
 - d. Keep to a minimum on-site removal of intact leaded paint.
 - e. Replace or enclose building components when elimination of intact leaded paint is performed.
 - f. Include visual inspection and clearance testing following lead hazard reduction work to ensure that lead levels are safe prior to the dwelling being re-occupied.
 - g. Include temporary occupant relocation or other measures to protect occupants from exposure to leaded dust produced by lead hazard control activities.
 - h. Relocate children permanently to lead-safe housing if necessary to reduce their lead exposure in a timely manner.

Sources: CDC, 2002; adapted with regard to CDC, 2012a, and to EPA's Renovation, Repair and Painting Rule (40 CFR 745, especially subpart E).

In some situations, the investigator and public health case manager will be unable to identify sources of lead exposure. The source may be obscure; the parent or guardian may be concealing information about someone, such as a babysitter or family member, whose interests they want to protect; or the parent or guardian may fear reprisal for disclosing certain information. This situation can best be handled by establishing a good rapport with the family and convincing them that the intent is not to find the family or any individual at fault but rather to help the child get well.

During the investigation and remediation, the investigator and public health team should discuss their concerns with the family in a clear and direct manner for the well-being of the child. If exposures continue, the child will be unable to get well. The best approach is to provide clear information and to maintain contact and open communication with the family. The public health case manager will continue to coordinate follow-ups for the child and family until the case is closed.

C. State/Local Housing Intervention

With prompt and effective environmental management as their priority, public-sector health and housing agencies should take joint responsibility for coordination of the housing effort for lead-poisoned children. This follow-up effort may involve working closely with the environmental investigator to control identified lead hazards in a timely manner. Housing officials can also use their access to State and locally managed properties and programs to ensure that lead-safe, temporary housing is available for families with lead-poisoned children and to pay for emergency services if needed to rapidly reduce exposure to lead hazards and protect children. The HUD Lead-Safe Housing Rule requires owners of rental housing receiving certain types of Federal financial assistance to respond promptly when informed that a lead poisoned child lives in an assisted unit (see Section I, above). HUD also requires public housing authorities to attempt to share and match information on addresses of families receiving Federal housing assistance with local health agencies that have information on children with EIBLL (24 CFR 35.1225(f)).

III. Lead Hazard Identification

Lead hazards are identified through the administration and evaluation of a questionnaire (see Tables 16.2 and Form 16.1) and through environmental sampling. Sampling procedures are addressed in Chapters 5 and 7 and Appendices 13.1, 13.2 and 13.3. The questionnaire should always be completed prior to sampling. Although a clear lead source may emerge from the answers to the questionnaire, the investigation of exposure sources in the child's residence should be thorough and complete. Environmental testing should be linked to the child's history and may include a prior residence or other areas frequented by the child. If another residence or childcare facility is identified as a probable source of lead exposure, appropriate environmental sampling should be conducted after discussion with the child's community or local health department. Testing should include the following samples at a minimum:

- ◆ X-ray fluorescence (XRF) or laboratory paint chip analysis of all defective paint or coatings on the child's residence including furniture, play structures, and on buildings frequented by the child.
- ◆ XRF or laboratory paint chip analysis of all impact and friction surfaces and surfaces that appear to have been chewed, including windowsills.
- ◆ Dust samples from areas frequented by the child, including play areas, porches, kitchens, bedrooms, and living and dining rooms. Additional dust samples may be collected from other surfaces (e.g. shoes, boots, cars) for which there are no standards; the information may be helpful in identifying other sources of exposure.
- ◆ Soil samples from bare soil areas, particularly child play areas (areas near the foundation of the house and areas from the yard). If the child spends significant time at a park or other public play area, samples should also be collected from these areas, unless the area has already been sampled.
- ◆ Where water testing is indicated, first-drawn and flushed water samples from the tap most commonly used for drinking water, infant formula, or food preparation.
- ◆ Where applicable, other media as appropriate including glazed tableware or ceramic cookware likely to contain lead.

**Table 16.2 Guidelines for Questions to Ask Regarding
a Child's Environmental History**

Paint and soil exposure

- ◆ What is the age and general condition of the residence?
- ◆ Is there evidence of chewed or peeling paint on woodwork, furniture, or toys?
- ◆ How long has the family lived at that residence?
- ◆ Have there been recent renovations or repairs in the house?
- ◆ Are there other sites where the child spends significant amounts of time?
- ◆ What is the character of indoor play areas?
- ◆ Do outdoor play areas contain bare soil that may be contaminated?
- ◆ How does the family attempt to control dust/dirt?

Relevant behavioral characteristics of the child

- ◆ To what degree does the child exhibit hand-to-mouth activity?
- ◆ Does the child exhibit pica?
- ◆ Are the child's hands washed before meals and snacks?

Exposures to and behaviors of household members

- ◆ What are the occupations of adult household members (Lead smelter, machining or grinding of lead alloys, battery or radiator manufacturing, home renovation/remodeling, demolition of old structures, steel bridge maintenance, welding or cutting of old painted metal, thermal stripping or sanding of old paint).
- ◆ What are the hobbies of household members? (Fishing, working with ceramics or stained glass, and hunting are examples of hobbies that involve risk for lead exposure.)
- ◆ Are painted materials or unusual materials burned in household fireplaces?

Miscellaneous questions

- ◆ Does the home contain vinyl mini-blinds made overseas and purchased before 1997?
- ◆ Does the child receive or have access to imported food, cosmetics, or folk remedies?
- ◆ Is food prepared or stored in imported pottery or metal vessels?

Managing Elevated Blood Lead Levels Among Young Children, CDC, March 2002

Table 16.3 Common Sources of Lead Exposure to Consider in an Environmental Investigation

(Less-common sources should be considered where appropriate – see Table 16.4)

Source	Standards ^a /Comments
Paint	<p><i>Existing paint in structures built prior to 1978, i.e., lead-based paint: 1 mg/cm² or 0.5% New paint: 90 ppm in dried paint film.</i></p> <p>Hazard is increased if leaded paint is deteriorated; present on surfaces subject to friction (e.g., window sashes) or impact (e.g., door knob banging); or disturbed during maintenance, repair, and renovation, especially during surface preparation for repainting.</p> <p>See the note on the lead-based paint standard, below.</p>
Interior dust	<p><i>Floors: 40 micrograms per square foot (µg/ft²) Interior window sills: 250 µg/ft² Window troughs: 400 µg/ft²</i></p> <p>See the note on these standards, below.</p>
Soil	<p><i>Bare play area soil: 400 ppm All other soil: 1200 ppm</i></p> <p>Dust on paved surfaces in urban areas often contains elevated lead concentrations.</p>
Drinking water	<p><i>First draw from tap (stagnant sample): 15 ppb</i></p> <p>Probability of contamination depends on the chemistry of the water. For communities served by public water systems, available data may indicate whether testing is likely to be helpful.</p>
Jobs, hobbies	<p>House dust may be contaminated with lead indirectly via contaminated work clothes, shoes, or hair. Direct contamination can occur from hobbies that generate lead fumes (from heating) or dust.</p>

^a The source of lead exposure should be controlled if the results of this sampling indicate that lead levels are equal to or greater than the limits listed below. These were the standards as of the publication of this edition of these *Guidelines*; at that time, in response to a petition received by the EPA on August 10, 2009, regarding the lead-based paint, dust-lead standards and clearance standards, EPA and HUD were reviewing those standards. (See <http://www.epa.gov/oppt/chemtest/pubs/petitions.html#petition5> for links to the petition and EPA's response.) Investigators should become familiar with their State and local jurisdiction standards, which may require action at a lower level. Investigators should consult the literature and the government web-sites to keep up to date with and follow the current regulations and guidance documents.

Lead-Based Paint

1.0 mg/cm² or 5,000 µg/g (0.5 percent).

Dust (by wipe sampling)

40 µg/ft² - floors

250 µg/ft² - windowsills

Clearance Standards

40 µg/ft² – interior floors.

250 µg/ft² – interior windowsills.

400 µg/ft² – window troughs [sometimes, improperly, called window wells].

Bare Residential Soil

400 ppm or µg/g in play areas

1200 ppm or µg/g in non-play areas [recommend for gardens].

Water

15 ppb, first draw, 1 L sample volume

Ceramic or Pottery Glazes

Soluble lead compounds can leach out of ceramic ware (these released compounds are called leachates) when the glaze is improperly fired or when the glaze has broken down because of wear from daily usage, particularly after repeated use in a microwave or dishwasher. Chips and cracks in ceramic ware also allow leaching of lead. When lead that is released into food and drink from ceramics, hazardous levels can contaminate food substances and expose children and adults to toxic levels. The leachate is liquid that, in passing through matter, extracts solutes, suspended solids or any other component of the material (such as lead) through which it has passed.

The U.S. Food and Drug Administration's (FDA's) compliance program guidelines on toxic elements in foodware describes FDA's approach to inspecting ceramic or pottery glazes for lead (FDA, 2003). The leachate for ceramic foodware is analyzed by graphite furnace atomic absorption spectrometry using Method 973.32 of the Association of Official Analytical Chemists (FDA, 2000b; FDA, 2005). The FDA uses the following ceramicware action levels (FDA, 2000a):

	µg/ml leaching solution
Flatware (average of 6 units)	3.0
Small hollowware (other than cups and mugs) (any 1 of 6 units)	2.0
Large hollowware (other than pitchers) (any 1 of 6 units)	1.0
Cups and mugs (any 1 of 6 units)	0.5
Pitchers (any 1 of 6 units)	0.5

IV. Lead Hazard Reduction

A. Time Limits

After reviewing the results of the questionnaire and the environmental sampling, immediate steps should be taken to remove and/or control the lead source from the dwelling unit or to relocate the child.

For public housing, certain other federally supported housing programs, and certain State and locally funded housing programs, regulations may require that all testing be completed within 15 days after an EIBLL child is identified. For example, this 15-day requirement applies to housing receiving federal assistance under programs covered by HUD's LSHR's subparts H, I, L or M (see Section I, above, for the subpart names, and see 24 CFR 35.730(a), 35.830(a), 35.1130(a), and 35.1225(a), for the respective regulatory requirements). For these HUD housing programs, interim control of all lead-based paint hazards must be completed within 30 days after receipt of the risk assessment report or the health department's evaluation (see 24 CFR 35.730(c), 35.830(c), 35.1130(c), and 35.1225(c).) See, also, Appendix 6.

Checking with the state, tribal and/or local jurisdiction is important, since they may have shorter time requirements than HUD's that will apply if the housing is receiving federal assistance, or they may have requirements that apply if the housing is not receiving federal assistance. If a child is present and the lead hazard reduction work will be delayed, short-term interventions, such as lead-safe dust removal, should be taken to rapidly reduce the child's exposure to lead hazards until the work will be conducted.

B. Modifications to Ordinary Lead-Based Paint Hazard Controls

Dwellings where extensive lead hazard control activities are occurring, particularly those that increase leaded dust levels, should achieve leaded dust clearance standards before the lead poisoned child and family reoccupy the dwelling. Children with EBL should not be permitted to reenter the dwelling at the end of the workday as indicated in Chapter 8. All children with EBL should leave the dwelling until *all* the lead hazard control work has been completed and clearance established, regardless of the size of the area to be treated. The child's family may need to be relocated temporarily to a dwelling free of lead-based paint hazards if interim controls of lead-based paint hazards are conducted (see 24 CFR 35.1345(a)(2) for the situations in which family relocation is required).

In some cases it may make sense for the family to move permanently to a lead-safe house. The owner may be required to facilitate such a move, or local government may assume some or all of the responsibility. In some cities, public housing authorities may be one source of providing lead-safe housing on an emergency basis. Local governments should consider implementing a system of prioritization to ensure that children with EBL are moved to a lead-safe dwelling as soon as possible. However, efforts to make sure that the original housing unit is made lead-safe are essential to preventing lead poisoning in other children who may move into the unit.

C. Elimination or Control of Other Lead Hazards

All lead hazards identified in the course of the investigation should be eliminated or controlled. If lead hazards not containing paint are identified, contact the appropriate agency and coordinate plans for hazard control with the local health department and the child’s case manager. Drinking water is usually regulated by the local public works agency or water and sewage authority. Notify State or local environmental regulatory agencies as appropriate. If probable occupational lead hazards are identified or contaminated work clothing is being taken into the dwelling, counsel the worker regarding the possibility of take-home exposures and inform him/her of the steps needed to protect family members. Where appropriate, work with the case manager to refer adult household members for blood lead testing. If occupational exposure is suspected, inform the federal Occupational Safety and Health Administration (OSHA) or the state, tribal or local occupational safety and health agency.

In some cases, no probable source of lead may be identified. In these instances, public health authorities should reassess possible sources of exposure, with increased emphasis on folk remedies and other culturally related exposures. A list of published reports of some less common sources of lead exposure is in Table 16.4, below.

Table 16.4 Published Reports of Less Common Causes of Elevated Blood Lead Levels (EBLs) in Children

(see Appendix I in CDC, 2000)

Exposure Source	Description/Exposure Pathway	Study Type*	Study Description
Occupational Take Home Exposures			
<i>Battery reclamation</i>	Lead carried home by battery workers. (Only a minority of battery workers showered or changed clothes before going home.)	E	Twelve (75%) of 16 children of lead-exposed workers had EBLs and a higher average BLL than neighborhood controls (22.4 vs. 9.8 µg/dL, p=.049).
<i>Ceramics</i>	Ceramic-coated capacitors made with fritted glass containing lead.	E	Case-control study of 51 children under 6 years (20 exposed, 31 controls) showed higher average BLLs in exposed children (13.4 vs. 7.1 µg/dL, p<.001).
<i>Furniture refinishing</i>	Lead carried home by workers who restored furniture that had undergone chemical stripping and was thought to be lead-free.	CR	Report of six workers and three of their children aged 4-18 months
<i>Construction</i>	Lead dust on skin and clothes taken home.	E	Case-control study of 50 children under 6 years (31 exposed, 19 controls) showed 25.8% of workers’ children had EBLs compared to 5.3% of control children (OR=6.1).
<i>Radiator repair</i>	Lead carried home by workers who did soldering to repair radiator.	E	The mean BLL for 18 children (under 7 years) of lead-exposed workers was 10 µg/dL.

**CHAPTER 16: INVESTIGATION AND TREATMENT OF DWELLINGS
THAT HOUSE CHILDREN WITH ELEVATED BLOOD LEAD LEVELS**

Exposure Source	Description/Exposure Pathway	Study Type*	Study Description
Imported Cosmetics			
<i>Kohl, Kajal (Middle East, India, Pakistan, some parts of Africa)</i>	A gray or black eye cosmetic applied to the conjunctival margins of the eyes. Can contain up to 83% lead. It is believed to strengthen and protect the eyes against disease. Also known as Al Kohl.	E	A study of 538 girls aged 6 to 12 years demonstrated that the application of kohl was associated with higher BLLs ($p=0.0461$).
<i>Pakistani eye cosmetics</i>	Eye cosmetics are often applied to the eyes of children.	E	Retrospective chart review of 175 children aged 8 months to 6 years showed an average BLL of 4.3 $\mu\text{g}/\text{dL}$ for Pakistani/ Indian children not using eye cosmetics and 12.9 $\mu\text{g}/\text{dL}$ for those using eye cosmetics ($p=0.03$).
<i>Surma (India)</i>	A black fine powder applied to the eyes for medicinal and cosmetic reasons.	E	A case-control study of 62 children demonstrated higher BLLs in children using surma ($p<.001$).
Contaminated Foods			
<i>Apple cider</i>	Cider was made in a maple syrup evaporator that had lead solder joining the interior seams.	CR	Report of a 7-year-old child.
<i>Flour (Middle East)</i>	Lead fillings used in stone mills contaminated flour.	E	Investigation of 43 symptomatic patients aged zero to 80 years and their families and of 563 children aged 10 to 18 years demonstrated that 33 (23%) of 146 community stone mills had lead contamination and that 171 (30.4%) of 563 children had BLLs exceeding 30 $\mu\text{g}/\text{dL}$.
<i>Lozeena</i>	An orange powder used to color rice and meat that contains 7.8%-8.9% lead.	CR	Report of brothers aged 2 and 3 years and their parents. In addition, 9 of 18 extended family members had EBLLs.
<i>Infant formula</i>	Infant formula was made with contaminated tap water from copper pipes with lead solder.	CR	Report (with environmental sampling data) of a 13-month-old child.
<i>Tamarind candy (Mexico)</i>	Tamarind candy jam products from Mexico. During the manufacturing process, the candied jam is packaged in stoneware or terra cotta ceramic jars that can leach lead.	CR	Report of two children under 6 years old, six older children, and one adult.

**CHAPTER 16: INVESTIGATION AND TREATMENT OF DWELLINGS
THAT HOUSE CHILDREN WITH ELEVATED BLOOD LEAD LEVELS**

Exposure Source	Description/Exposure Pathway	Study Type*	Study Description
Beverage Containers			
<i>Bulk-water storage tank</i>	Lead leached from soldered seams and brass fittings in bulk-water storage tanks.	CR	Report of three children aged 6, 12, and 14 months.
<i>Ceramic glaze</i>	Lead in ceramic glaze can leach into stored beverages, especially juices since they are acidic. The risk is highest for improperly fired containers.	CR	Multiple reports.
<i>Cocktail glass</i>	Lead leached from cocktail glass.	CR	Report of a family with one adult and children aged 4, 5, and 14 years.
<i>Iranian urn (samovar)</i>	Lead spot solder from the original manufacturing process leached into water used to make baby formula.	CR	Reports of a 10-week-old child with seizures and of a 4-month-old child.
<i>Lead-soldered kettle</i>	Lead leached into infant formulas.	CR	Reports of a 3-month-old child and of a 1-day-old child.
Folk Remedies			
<i>Azarcon</i>	Also known as alarcon, coral, luiga, maria luisa, or rueda . Bright orange powder used to treat empacho (an illness believed to be caused by something stuck in the gastrointestinal tract, resulting in diarrhea and vomiting). Azarcon is 95% lead.	E	Report of 15-month-old and 3-year-old siblings who expired with seizures and a subsequent survey of 545 systematically selected households for azarcon and greta usage.
<i>Ayurvedic medicine (Tibet)</i>	Unnamed folk medicine.	CR	Single case.
<i>Ba-Baw-San (China)</i>	Herbal medicine used to treat colic pain or to pacify young children.	E	Study of 319 children aged 1 to 7 years demonstrated that consumption was associated with increased BLLs ($p=.038$).
<i>Bint Al Zahab (Iran)</i>	Rock ground into a powder and mixed with honey and butter given to newborn babies for colic and early passage of meconium after birth.	CR	Report of six children aged 2 days to 3 months.
<i>Bint Dahab (Saudi Arabia; means "daughter of gold")</i>	A yellow lead oxide used by local jewelers and as a home remedy.	CR	Report of 10 children aged 7 days to 13 months, including three who took bint dahab.

Exposure Source	Description/Exposure Pathway	Study Type*	Study Description
Folk Remedies (continued)			
Bokhoor (Kuwait)	A traditional practice of burning wood and lead sulphide to produce pleasant fumes to calm infants.	CR	Report of four children aged 16 days to 4.5 months.
Ghasard	Brown powder used as a tonic to aid in digestion.	CR	Report of a 9-month-old child who died.
Greta (Mexico)	Yellow powder used to treat empacho (see azarcon); can be obtained through pottery suppliers, as it is also used as a glaze for low-fired ceramics. Greta is 97% lead.	E	See azarcon .
Jin Bu Huan (China)	An herbal medicine used to relieve pain.	CR	Report of three children aged 13 and 23 months and 2.5 years.
Pay-loo-ah (Vietnam)	A red powder given to children to cure fever or rash.	CR	Report of a 6-month-old child.
Po Ying Tan (China)	An herbal medicine used to treat minor ailments in children.	CR	Report of a 4-month-old child.
Santrinj (Saudi Arabia)	An amorphous red powder containing 98% lead oxide used principally as a primer for paint for metallic surfaces, but also as a home remedy for "gum boils" and "teething."	CR	Report of 10 children aged 7 days to 13 months, including 7 who took santrinj.
Surma (India)	Black powder used as a cosmetic and as teething powder.	E	A case-control study of 62 children demonstrated higher BLLs in children using surma ($p < .001$).
Tibetan herbal vitamin	Used to strengthen the brain.	CR	Report of a 5-year-old child.
Saudi folk medicine	Orange powder prescribed by a folk medicine practitioner for teething; also has an antidiarrheal effect.	CR	Report of three children aged 11, 22, and 44 months.
Miscellaneous			
Automobile key-chain emblem	Ingestion of lead-containing automobile key-chain emblem.	CR	Report of a 23-month-old child.
Clothing accessory	Ingestion of a "simulated watch."	CR	Report of 3-year-old child who required endoscopy.

Exposure Source	Description/Exposure Pathway	Study Type*	Study Description
Miscellaneous (continued)			
<i>Curtain weights</i>	Ingestion of lead-containing curtain weights.	CR	Report of deaths of a 23-month-old child and a 2-year-old child.
<i>Fishing sinkers</i>	Ingestion of a lead-containing fishing sinker.	CR	Report of an 8-year-old.
<i>Gasoline sniffing</i>	Lead in gasoline absorbed through gasoline sniffing.	CR	Report of six of seven siblings aged 10 to 17 years.
<i>Lead bullet</i>	Lead absorbed from a retained bullet.	CR	Report of one adult and review of 18 other cases including seven children under 2 years old.
<i>Lead pellets</i>	Ingestion of lead pellets from pellet gun.	CR	Report of a 6-year-old child.
<i>Lead shot and toy (boat keel)</i>	Lead shot used in a toy boat keel that was eaten by a child.	CR	Report of a 4-year-old child.
<i>Newsprint fireplace log</i>	Lead inhaled during burning of a log made from old newsprint.	CR	Report of a 6-month-old child.
<i>Pool cue chalk</i>	Lead contained in pool cue chalk.	CR	Report of two children aged 28 and 27 months.
<i>Vinyl miniblinds</i>	Lead dust from vinyl miniblinds.	E	A study of 92 children aged 6 to 72 months attributed 9% of lead poisoning cases to vinyl miniblind exposure.

*CR = case report, E = epidemiological study

See, also, the CDC lead website's pages for information and links about, for example:

- ◆ Folk Medicine (<http://www.cdc.gov/nceh/lead/tips/folkmedicine.htm>), regarding lead in some traditional (folk) medicines from a variety of cultures.
- ◆ Candy (<http://www.cdc.gov/nceh/lead/tips/candy.htm>), regarding lead from candy imported from Mexico.
- ◆ Sindoor (<http://www.cdc.gov/nceh/lead/tips/sindoor.htm>), regarding lead poisoning related to ingesting sindoor, a red powder, typically used as a cosmetic and in certain religious ceremonies, but which has been used as a food additive.
- ◆ Toy jewelry (<http://www.cdc.gov/nceh/lead/tips/jewelry.htm>), regarding swallowing lead jewelry or putting it in the mouth.
- ◆ Toys (<http://www.cdc.gov/nceh/lead/tips/toys.htm>), especially regarding toys imported into the U.S., or antique toys and collectibles passed down.

- ◆ Artificial turf (<http://www.cdc.gov/nceh/lead/tips/artificialturf.htm>), of which some made of nylon or nylon/polyethylene blend fibers contain levels of lead that pose a potential public health concern when they show signs of weathering, including fibers that are abraded, faded or broken.

The CDC lead website also has pages of general interest, and particular interest when no probable source of lead may be identified, regarding At-Risk Populations (<http://www.cdc.gov/nceh/lead/tips/populations.htm>), including linked pages with information and further links on:

- ◆ International adoption and prevention of lead poisoning (<http://www.cdc.gov/nceh/lead/tips/adoption.htm>), for adopting parents, adoption agencies, and health care providers.
- ◆ Refugees (<http://www.cdc.gov/nceh/lead/tips/refugees.htm>), with a link to CDC's Lead Poisoning Prevention in Newly Arrived Refugee Children tool kit page (http://www.cdc.gov/nceh/lead/Publications/RefugeeToolKit/Refugee_Tool_Kit.htm) and, from there, to the tool kit itself (<http://www.cdc.gov/nceh/lead/Publications/RefugeeToolKit/pdfs/CDCRecommendations.pdf>). The webpage provides recommendations for primary prevention of EBLs, identification of children with EBLs, early post-arrival evaluation and therapy, and health education/outreach. The tool kit is divided into three sections, a refugee resettlement worker module (for state and local health departments, refugee coordinators, refugee health coordinators, and others involved with the well-being and resettlement of refugees), a medical provider module (for those involved with direct medical services to refugees) and resources (for refugee resettlement workers, medical providers and others interested in refugee issues).
- ◆ Pregnant Women (<http://www.cdc.gov/nceh/lead/tips/pregnant.htm>), with guidance for pregnant women and links to the CDC's Guidelines for the Identification and Management of Lead Exposure in Pregnant and Lactating Women (<http://www.cdc.gov/nceh/lead/publications/LeadandPregnancy2010.pdf>) for health care providers and public health professionals, and a CDC Podcast about the guidelines (<http://www2.cdc.gov/podcasts/player.asp?f=3467768>).

The CDC lead website has a page listing and providing links to dozens of Childhood Lead Poisoning Publications, arranged by topic:

- ◆ Data and Surveillance Reports
- ◆ Health Care Systems/Insurance Guidelines
- ◆ International Response
- ◆ Lead Exposure Case Studies
- ◆ Lead Policy Statements
- ◆ Lead Toxicology Reports
- ◆ Primary Prevention Guidelines
- ◆ Screening and Case Management Guidelines

Case management will continue until case closure, based on decline in the child's blood lead level, control of identified lead hazards, and completion of an individualized plan for follow-ups.

References

CDC, 2002. Centers for Disease Control and Prevention. Managing Elevated Blood Lead Levels Among Young Children: Recommendations from the Advisory Committee on Childhood Lead Poisoning Prevention, Chapter 2, "Assessment and Remediation of Residential Lead Exposure." March 2002. See http://www.cdc.gov/nceh/lead/CaseManagement/caseManage_main.htm.

CDC, 2012a. Centers for Disease Control and Prevention. CDC Response to Advisory Committee on Childhood Lead Poisoning Prevention Recommendations in "Low Level Lead Exposure Harms Children: A Renewed Call of Primary Prevention." May 2012. http://www.cdc.gov/nceh/lead/ACCLPP/CDC_Response_Lead_Exposure_Recs.pdf

CDC, 2012b. Centers for Disease Control and Prevention. Fact Sheet: Blood Lead Levels in Children – Important Information for Parents. May 2012. http://www.cdc.gov/nceh/lead/ACCLPP/Lead_Levels_in_Children_Fact_Sheet.pdf

CDC ACCLPP, 2012. Centers for Disease Control and Prevention Advisory Committee for Childhood Lead Poisoning Prevention. Low Level Lead Exposure Harms Children: A Renewed Call of Primary Prevention. March 2012. http://www.cdc.gov/nceh/lead/ACCLPP/Final_Document_030712.pdf

FDA, 2000a. U.S. Food and Drug Administration, Center for Food Safety and Applied Nutrition. Action Levels for Poisonous or Deleterious Substances in Human Food and Animal Feed (CPG 545.450), August 2000. See <http://www.fda.gov/Food/GuidanceComplianceRegulatoryInformation/GuidanceDocuments/ChemicalContaminantsandPesticides/ucm077969.htm#lead>.

FDA, 2000b. U. S. Food and Drug Administration, Center for Food Safety and Applied Nutrition. Elemental Analysis Manual for Food and Related Products. January 2000. See <http://www.fda.gov/Food/ScienceResearch/LaboratoryMethods/ElementalAnalysisManualEAM/ucm221685.htm>. Method 4.2 - Graphite Furnace Atomic Absorption Spectrometric Determination of Lead and Cadmium Extracted from Ceramic Foodware. See <http://www.fda.gov/Food/ScienceResearch/LaboratoryMethods/ElementalAnalysisManualEAM/ucm224852.htm>.

FDA, 2003. U.S. Food and Drug Administration. Compliance Program Guidance Manual 7304.019, Toxic Elements in Food and Foodware, and Radionuclides in Food – Import and Domestic, Chapter 04 – Pesticide and Chemical Contaminants. August 4, 2003. See <http://www.fda.gov/downloads/Food/GuidanceComplianceRegulatoryInformation/ComplianceEnforcement/ucm073204.pdf>.

FDA, 2005. U.S. Food and Drug Administration, Office of Regulatory Affairs. ORA Laboratory Manual, Volume IV, Section 6-Elemental Analysis. See http://www.fda.gov/ora/science_ref/lm/vol4/section/06.pdf

Form 16.1 Resident Questionnaire for Investigation of Children with Elevated Blood Lead Levels (EBL)

General Information

1. Where do you think the child is exposed to the hazard? _____

2. Do you rent or own your home? rent own
 If rented, are there any rent subsidies? yes no
 If yes, what type: Public housing authority Section 8 _____ Federal Rent Subsidy
 Other (specify) _____

Landlord information (or Rent Collector Agent)

Name: _____

Address: _____ Phone: _____

3. When did you/your family move into this home? (month/year) _____

**Complete the following for all addresses where the child
has lived during the past 12 months, including this home.**

Dates of Residency	Address Include City and State	Approximate Year Built	General Condition of Dwelling: Any renovation or deteriorated paint?

**Form 16.1 Resident Questionnaire for Investigation
of Children with EBL (2 of 9)**

4. Is the child cared for away from the home? (This includes preschool and/or child care at a center, dedicated home, or with a friend or relative.)

If yes, complete the following table.

Type of Care	Location of care Contact name, address and phone	No. hours/wk at location	General Condition of Dwelling: Any renovation or deteriorated paint?

Lead-Based Paint and Lead-Contaminated Dust Hazards

1. Has this dwelling been tested for lead-based paint or lead-contaminated dust? yes no
If yes, when? _____ Where can this information be obtained? _____
3. Approximately what year was the dwelling built? _____
a. If unknown, was it before 1950? yes no
3. Has there been any recent repainting, remodeling, renovation, window replacement, sanding or scraping of painted surfaces inside or outside this dwelling unit? If yes, describe activities, time and duration of work.

4. Has any lead abatement or other lead hazard control work been conducted at this dwelling recently?
 yes no
5. Where does the child like to play, hide, or frequent? (Include rooms, closets, porches & outbuildings)

Form 16.1 Resident Questionnaire for Investigation of Children with EBL (3 of 9)

Use the table below.

Areas where the child likes to play, hide, or frequent	Paint condition* (intact, not intact, or not present)	Location of painted component with visible bite marks

** Paint condition: Note location and extent of any visible chips and/or dust in window wells, on window sills, or on the floor directly beneath windows. If you see peeling, chipping, chalking, flaking, or deteriorated paint, make sure you include the locations and extent of deterioration.*

Assessment - Probable: lead-based paint hazard lead-dust hazard no lead hazard

Actions:

- Obtain records of previous environmental testing noted above.
- XRF inspection of dwelling (check one) limited complete
- Paint testing of deteriorated paint: add to Form 5.3.
- Leaded dust sampling of home: add additional areas to Form 5.4 list of rooms to be sampled
- Other sampling (specify): _____

Water Lead Hazards

Determine whether the dwelling is located in a jurisdiction known to have lead in drinking water in either public municipal or well water. Consult with state/local public health authorities for details.

Check one: at risk not at risk

1. What is the source of drinking water for the family? Municipal water Private well
 Other (specify): _____

(This information will be used to help determine responsibility and methods of controlling lead exposures from water.)

If tap water is used for drinking, answer questions 2 through 6. If not, go to Lead in Soil Hazards.

**Form 16.1 Resident Questionnaire for Investigation
of Children with EBL (4 of 9)**

2. From which faucets do you obtain drinking water? (Sample the main drinking water faucet.)

3. Do you use the water immediately? yes no
Do you let the water run for a while first? yes no
(If water-lead levels are elevated in the first draw, but low in the flushed sample, recommend flushing the water if it has not been used for more than 6 hours before drinking.)
4. Is tap water used to prepare infant formula, powdered, milk, or juices for the children? yes no
If yes, do you use hot or cold tap water? hot cold
If no, from what source do you obtain water for the children? _____
5. Has new plumbing been installed within the last 5 years? yes no
If yes, identify location(s). _____
Did you do any of this work yourself? yes no
If yes, specify. _____

Assessment: water lead hazard risk no water lead hazard risk

Actions:

- Test water (first draw and flush samples).
- Other testing (specify): _____

- Counsel family (specify): _____

Lead in Soil Hazards

Use the following information to determine where soil samples should be collected.

1. Where outside does the child like to play? _____
2. Where outside does the child like to hide? _____
3. Is this dwelling near a lead-producing industry (such as a battery plant, smelter, radiator repair shop, boat keel manufacturer, electronics plant, or soldering plant)? yes no
4. Is the dwelling located within two blocks of a major roadway, freeway, elevated highway, or other transportation structure? yes no
5. Are buildings or structures on the property or nearby being renovated, repainted, or demolished:
 yes no
If no: Has any of this kind of work been done recently: yes no
6. Is there deteriorated paint on outside fences, garages, play structures, railings, building siding, windows, trims, or mailboxes: yes no

Form 16.1 Resident Questionnaire for Investigation of Children with EBL (5 of 9)

7. Were gasoline or other solvents ever used to clean parts or disposed of at the property: yes no
8. Are there any visible paint chips near the perimeter of the house, fences, garages, or play structures?
 yes no

If yes, note location(s). _____

9. Has soil ever been tested for lead: yes no
If yes, when and where can this information be obtained? _____

10. Have you burned painted wood in a woodstove or fireplace? yes no
If yes, have you emptied ashes onto soil? yes no
If yes, where? _____

Assessment: probable soil lead hazard no soil lead hazard risk

Actions:

- Test soil (single samples of bare soil where children play). Complete Form 5.5 for Field Sampling.
- Advise family to obtain washable doormats for entrances to the dwelling
- Counsel family to keep children away from bare soil areas thought to be at risk (specify).
- Counsel family to cover bare soil areas with mulch or other material.
- Counsel family to remove the cause of lead contamination.

Additional Notes:

Occupational and Hobby Lead Hazards

Use the information in this section to determine if the child may be exposed to lead due to the work environment or hobby of parents, siblings, or other adults. Occupations that may cause exposure include:

Paint removal (e.g., sandblasting, scraping, sanding, abrasive blasting, using heat guns or torches)	Remodeling, repairing, or renovating dwellings or buildings, or demolition (tearing down buildings or metal structures like bridges)
Chemical Strippers	Working at a firing range
Plumbing	Making batteries
Repairing radiators	Making paint or pigments
Melting metal for reuse (smelting)	Painting
Welding, burning, cutting or torch work	Salvaging metal or batteries
Pouring molten metals (foundries)	Making or splicing cable or wire
Auto body repair work	Creating explosives or ammunition
Making or repairing jewelry	Making pottery
Building, repairing or painting ships	Working in a chemical plant, glass factory, oil refinery, or any other work involving lead
Soldering electrical connections	

**Form 16.1 Resident Questionnaire for Investigation
of Children with EBL (6 of 9)**

Answer the following questions.

1. Where does anyone in the household and any frequent visitors work? (Include parents, older siblings, and other adults)

Name	Place of Employment	Occupation	Probable Exposure
			<input type="checkbox"/> yes <input type="checkbox"/> no
			<input type="checkbox"/> yes <input type="checkbox"/> no
			<input type="checkbox"/> yes <input type="checkbox"/> no
			<input type="checkbox"/> yes <input type="checkbox"/> no
			<input type="checkbox"/> yes <input type="checkbox"/> no

2. Are work clothes separated from other laundry? yes no
3. Has anyone in the household removed paint or varnish while in the dwelling?
(This includes paint removal from woodwork, furniture, cars, bicycles, boats, etc.) yes no
4. Has anyone in the household soldered electric parts while at home? yes no
5. Does anyone in the household apply glaze to ceramic or pottery objects? yes no
6. Does anyone in the household work with stained glass? yes no
7. Does anyone in the household use artist's paints to paint pictures or jewelry? yes no
8. Does anyone in the household reload bullets, target shoot, or hunt? yes no
9. Does anyone in the household melt to make bullets, fishing sinkers, or toys? yes no
10. Does anyone in the household work on auto body repair at home or in the yard: yes no
11. Is there evidence of take-home work exposures or hobby exposures in the dwelling? yes no

Assessment Probable:

- occupational related lead exposure hobby related lead exposure neither

Actions:

- Counsel family (specify) _____
- Refer to (specify): _____

**Form 16.1 Resident Questionnaire for Investigation
of Children with EBL (7 of 9)**

Child Behavior Risk Factors (Evaluate each child under age 6.)

1. Does the child suck his/her fingers? yes no
2. Does child put painted objects in the mouth? yes no
If yes, specify: _____

3. Does child chew on painted surfaces, such as old painted cribs, windowsills, furniture edges, railings, door molding, or broom handles? yes no
If yes, specify: _____

4. Does the child chew on putty around windows? yes no
5. Does the child put soft metal objects in the mouth? yes no
These may include lead and pewter toys and toy soldiers, jewelry, gunshot, bullets, beads, fishing sinkers, or items containing solder (e.g., electronics).
6. Does the child chew or eat paint chips or pick at painted surfaces? yes no
7. Is the paint intact in the child's play areas? yes no
8. Does the child put foreign, printed material (newspapers, magazines) in the mouth? yes no
9. Does the child put matches in the mouth? (may contain lead acetate) yes no
10. Does the child play with cosmetics, hair preparations, or talcum powder or put them in the mouth?
 yes no If yes, are any of these products foreign made? yes no
11. Does the child have a favorite: cup? yes no eating utensil? yes no
If yes, are either of them handmade or ceramic? yes no
12. Does the child have a dog, cat, or other pet that could track in contaminated soil or dust from outside?
 yes no If yes, where does the pet sleep? _____
13. Where does the child obtain drinking water? _____
14. If a child is present, note the extent of hand-to-mouth behavior observed. _____

**Form 16.1 Resident Questionnaire for Investigation
of Children with EBL (8 of 9)**

Assessment if Child is at Risk:

- Hand-to-mouth behavior
- Mouthing probable lead-containing source
- Other behavior (specify) _____
- No observed at-risk behavior

Actions:

Counsel family to limit access to use of (specify) _____
Other (specify) _____

Other Household Risk Factors

1. Are imported cosmetics, such as Kohl™, Surma™, or Ceruse™, used in the home? yes no
2. Does the family ever use any home remedies or herbal treatments? yes no
If yes, what type? _____
3. Are any liquids stored in metal, pewter, or crystal containers? yes no
4. What containers are used to prepare, serve, and store the child's food? _____

Are any of the imported potteries, metal, soldered, or glazed? yes no
Does the family cook with a ceramic bean pot? yes no
5. Does the family use imported canned items regularly? yes no
6. Does the child play in, live in, or have access to any areas where the following materials are kept: shellacs, lacquers, driers, coloring pigments, epoxy resins, pipe sealants, putty, dyes, industrial crayons or markers, paints, pesticides, fungicides, gear oil, detergents, old batteries, battery casings, fishing sinkers, lead pellets, solder, or drapery weights? yes no
7. Does the child take baths in an old bathtub with deteriorated or nonexistent glazing? yes no
8. Does the home contain vinyl mini-blinds made overseas and/or purchased before 1997? yes no

Assessment if Child is at Risk:

- Increased risk of lead exposure due to: _____
- No observed risk

Actions:

- Counsel family to limit access or use (specify): _____
- Other (specify) _____

Form 16.1 Resident Questionnaire for Investigation of Children with EBL (9 of 9)

Assessment for Likely Success of Temporary Hazard Control Measures

1. What cleaning equipment does the family have in the dwelling?
 broom mop & bucket vacuum that works sponge & rags
2. How often does the family:
 Sweep the floors? _____ Wet mop the floors? _____
 Vacuum the floors? _____ Wash the windowsills? _____
 Wash the window troughs? _____
3. What type of floor coverings are found in the dwelling? (check all that apply)
 vinyl/linoleum carpeting wood other (specify): _____
4. Are floor coverings smooth and cleanable? yes no
5. Cleanliness of dwelling (check one using table below)
 appears clean some evidence of housecleaning no evidence of housecleaning

Appears Clean	Some evidence of housecleaning	No evidence of housecleaning
No visible dust on most surfaces	Slight dust buildup in corners	Heavy dust buildup in corners
Evidence of recent vacuuming	Slight dust buildup on furniture	Heavy dust buildup on furniture
No matted or soiled carpeting	Slightly matted and/or soiled carpeting	Matted and/or soiled carpeting
No debris or food scattered about	Some debris or food scattered about	Debris or food scattered about
Few visible cobwebs	Some visible cobwebs	Visible cobwebs
Clean kitchen floor	Slightly soiled kitchen floor	Heavily soiled kitchen floor
Clean door jambs	Slightly soiled door jambs	Heavily soiled door jambs

Assessment if Child is at Risk:

- Cleaning equipment inadequate
- Cleaning routine inadequate
- Floor coverings inadequate to maintain clean environment
- No observed risk

Actions:

- Counsel family to limit access or use (specify room and location): _____

- Provide cleaning equipment
- Instruct family on special cleaning methods
- Demonstrate special cleaning methods
- Flooring treatments needed (specify rooms) _____

- Other (specify) _____



Chapter 17: **(Reserved For Future Use)**

Chapter 18: Lead-Based Paint and Historic Preservation

HOW TO DO IT	18-3
I. Introduction.....	18-6
II. Use of Lead-Based Paint in Historic Properties	18-6
III. Standards for the Treatment of Historic Properties.....	18-6
IV. Property Evaluation	18-8
A. Evaluating the Significance of a Property.....	18-8
B. Risk Assessment/Paint Inspection	18-10
V. Establishing Priorities for Intervention.....	18-10
VI. Selecting Interim Controls or Abatement.....	18-10
VII. Selecting Abatement Methods Other Than Paint Stabilization	18-11
A. Paint Removal.....	18-11
B. Component Removal and Replacement.....	18-13
C. Encapsulation.....	18-14
D. Enclosures	18-14
VIII. Conclusions.....	18-14
IX. Historic Preservation Project Case Study.....	18-15
A. Historic Significance:	18-15
B. LBP Evaluation:	18-15
C. Lead hazard control:	18-16
D. The scope of the work:	18-16
E. Project completion:	18-17
FIGURES	
Figure 18.1 Delicate muntins and multi-pane sash on row houses	18-9
Figure 18.2 Window condition assessment.....	18-9
Figure 18.3a Historic property before rehabilitation.....	18-10
Figure 18.3b Historic property after rehabilitation.....	18-10
Figure 18.4 Wood features on historic properties.....	18-12
Figure 18.5 Doors to historic property before off-site stripping.....	18-13
Figure 18.5b Doors to historic property after off-site stripping.....	18-13
Figure 18.6 Enclosure of stairs not appropriate in a historic property.....	18-14

Intentionally Left Blank

Chapter 18: Lead-Based Paint and Historic Preservation

How To Do It

- Determine if the dwelling is historic.** It may be listed on the National Register of Historic Places, a state register, or other local inventory.
 - ✦ If a building is over 50 years old and retains its historic features, it may be eligible for listing.
 - ✦ If Federal funds are involved in a lead-based paint hazard control project (whether using interim controls or abatement), the grantee must first determine if the dwelling is listed on or eligible for the National Register of Historic Places and consult with the State Historic Preservation Officer (SHPO) about how the work is done. Federal regulations (36 CFR Part 800) outline the process, commonly referred to as the Section 106 review. Information about the Section 106 review process is available on the HUD Assessment Tools for Environmental Compliance (ATEC) website: http://portal.hud.gov/hudportal/HUD?src=/program_offices/comm_planning/environment/review/historic.
 - ✦ For agencies or organizations expecting to undertake lead hazard control activities in a large number of homes, a Programmatic Agreement with the SHPO should be developed. The agreement can contain a list of treatments that are exempt from review, and otherwise streamline the review process.
- Identify important historic building features that should be preserved if possible.** With the assistance of trained historic preservation architects, architectural historians, or SHPO staff, determine which architectural elements and character-defining features of the historic building can be preserved.
- Establish priorities for intervention.** In historic properties, interim controls are generally preferred over abatement strategies because they preserve the integrity of the structure.
 - ✦ Determine if the scope of the project should involve interim controls, or if abatement of all paint or lead-based based paint hazards is required.
 - ✦ If the property receives federal housing assistance, the amount and type of housing assistance may contribute to a determination of the approach(es) taken to control lead hazards. The Lead Safe Housing Rule applies if the property receives federal housing or rehabilitation assistance. (24 CFR Part 35, Subparts B–R; see Appendix 6.) For example:
 - Public Housing Agencies require abatement of all lead-based paint during modernization of historic Public Housing properties (but see below); and
 - HOME Investment Partnership (HOME) or Community Development Block Grant (CDBG)-funded projects that disturb lead-based paint require interim controls, and may require ongoing lead-based paint maintenance and reevaluation afterwards, if the cost of the project is up to \$25,000 per housing unit (apart from lead hazard control costs); and require lead-based paint hazard abatement if over that amount (but see below).
 - ✦ Even when the Lead Safe Housing Rule requires abatement in an historic property, if the SHPO requests that interim controls may be conducted instead, with, ongoing lead-based paint maintenance and reevaluation conducted afterward if required by the Rule, they may be used instead of abatement.

4. **Have a combination lead-based paint risk assessment and inspection performed by a certified lead-based paint inspector/risk assessor.** Keep the report and related records to guide future rehabilitation and maintenance work. If properties are of exceptional historical significance, label and store paint samples to assist in future preservation analysis.
5. **Assess the risk of lead exposure for each significant architectural item to determine, in the context of historic preservation standards, what type of intervention is needed, its cost, and its feasibility in order to make the residence lead-safe.** It is possible to strike a balance between lead safety and preservation. HUD requires abatement of lead-based paint or hazards, using methods such as replacement, only in certain cases (see item 3, above). Wholesale removal of historically significant building components as a lead hazard control methodology is not recommended in historic properties. More often, the less serious lead hazards may only require repair and paint stabilization.
6. **Discuss the hazard control strategy with the SHPO and give special consideration to those methods that do not destroy significant architectural features and finishes.** Refer to the following related documents:
 - ◆ The Secretary of the Interior's Standards for the Treatment of Historic Properties (1992); these standards (published at 36 CFR Part 68) are also in the following document;
 - ◆ The Secretary of the Interior's Standards for the Treatment of Historic Properties with Guidelines for Preserving, Rehabilitating, Restoring & Reconstructing Historic Buildings (2001) (<http://www.nps.gov/history/hps/tps/standguide/>);
 - ◆ The Secretary of the Interior's Standards for Rehabilitation & Illustrated Guidelines for Applying the Standards (1995) (<http://www.nps.gov/tps/standards/rehabilitation/rehab/>), covering the standards for rehabilitation (published at 36 CFR Part 67);
 - ◆ The Secretary of the Interior's Standards for Rehabilitation & Illustrated Guidelines on Sustainability for Rehabilitating Historic Buildings (2011) (<http://www.nps.gov/tps/standards/rehabilitation/sustainability-guidelines.pdf>); and, especially;
 - ◆ National Park Service Preservation Brief 37, "Appropriate Methods for Reducing Lead-Paint Hazards in Historic Housing" (2006) (<http://www.nps.gov/history/hps/tps/briefs/brief37.htm>).
7. **Avoid removal of significant historic materials, avoid the use of harsh abrasive cleaners or chemicals that may damage historic materials, and avoid covering over historic siding, whenever possible and financially feasible.**
8. **Comply with all worker safety and health requirements (including those in Chapter 9 and Appendix 6) and use only approved paint removal methods.** If paint is to be removed, the preferred treatments include: wet sanding of deteriorated peeling paint; finish sanding with special mechanical sanders with a high-efficiency particulate air (HEPA) vacuum local exhaust ventilation; low-heat paint stripping; chemical strippers (except methylene chloride); and offsite stripping with heat or chemicals. Never use open flame or high heat removal of paint, or dry sanding or uncontained abrasive removal.
9. **As appropriate, negotiate a Programmatic Agreement and a Memorandum of Agreement for treatment of the property.** A Programmatic Agreement records terms and conditions agreed upon to resolve the potential for adverse effects of a Federal agency program, complex undertaking or other situation, while a Memorandum of Agreement details the terms permitting a particular project to proceed.
10. **Provide materials to the residents describing the project, and the presence of any remaining lead-based paint upon completion of the project, and guidance on keeping the housing lead-safe.**

- ◆ Prompt notification to occupants of testing and hazard control results is required for projects receiving federal housing or rehabilitation assistance, and is recommended for other projects.
 - ◆ Disclosure of testing and hazard control project results to prospective renters and buyers during subsequent lease or sale actions is required in accordance with the Lead Disclosure Rule (24 CFR Part 35, Subpart A; see Appendix 6), whether or not the project is covered by federal housing or rehabilitation assistance.
 - ◆ Providing information to occupants on appropriate housekeeping methods to keep the historic property in a lead-safe condition after lead hazard control work is recommended.
11. **Lead Hazard Control measures that meet the Secretary of the Interior’s Standards may be eligible for a tax credit.** If undertaken as part of a qualifying rehabilitation on an income-producing property, lead hazard control measures may be eligible for the 20% federal Historic Rehabilitation Tax Credit. Information about the tax credit program is available at <http://www.nps.gov/tps/tax-incentives/before-you-apply.htm>. Some states also offer state-level historic rehabilitation tax credits, which when combined with the federal tax credit, could provide significant preservation incentive. Investors and entities performing preservation work should explore other leveraging resources as time permits.

I. Introduction

Historic buildings provide quality, affordable housing in urban and rural areas throughout the country. They give communities a strong sense of tradition and pride. To preserve those values, historic buildings warrant special consideration in lead hazard control activities. Some treatments for lead hazard control can cause irreversible damage to historic properties. Such actions, when federally assisted, are subject to special review procedures to avoid adverse effects and protect historic properties. Section 106 of the National Historic Preservation Act (16 U.S.C. Section 470 *et seq.*) and its implementing regulations, 36 CFR Part 800, require Federal agencies to take into account the effects of their undertakings on historic properties and to afford the federal Advisory Council on Historic Preservation (ACHP; <http://www.achp.gov>) a reasonable opportunity to comment on such undertakings when historic properties may be adversely affected. Every State and unit of general local government receiving HUD Community Development Block Grants (CDBG), HOME Investment Partnerships (HOME), or other HUD housing program assistance should be familiar with the regulations, since they must comply with Section 106 as part of the environmental review for program activities. If the agency responsible for lead-based paint abatement or hazard control (and the environmental review) is not familiar with the Section 106 process, they should contact their State Historic Preservation Officer (SHPO), the HUD Field Environmental Officer, or the State or local agency administering the CDBG or HOME programs for assistance. (Contact information for the SHPOs is at <http://www.cr.nps.gov/nr/shpolist.htm>. A list of HUD local environmental contacts is at <http://www.hud.gov>, search for “environmental officers” in quotes).

Implementing the guidance in this chapter will help ensure compliance with Section 106. If an agency or organization is planning to undertake lead hazard control in a large number of homes, a Programmatic Agreement could significantly reduce the time needed for consultation with the SHPO. A Programmatic Agreement records terms and conditions agreed upon to resolve the potential for adverse effects of a Federal agency program, complex undertaking or other situation. Many states and local government agencies have existing Programmatic Agreements for HUD programs like, CDBG and HOME, which can be amended to include lead-based paint hazard control activities.

Also, a Memorandum of Agreement between the responsible entity and SHPO detailing the terms permitting a particular project to proceed may also be used, such as if meeting the Secretary’s Standards is economically prohibitive or otherwise not feasible, or if the parties find it helpful to lay out the terms for other reasons.

II. Use of Lead-Based Paint in Historic Properties

Since lead-based paint was commonly used until the 1950s and was not banned from residential use until 1978, it is often present in historic buildings. See Chapter 1. Lead-based paint is generally found on wooden trim and all surfaces that normally received gloss enamel or oil paints (e.g., metal grills and radiators often were painted with lead-rich enamels). Early calcimine and milk paints that were primarily waterborne were often thought to be lead-free, but many of the color pigments contained lead. Significant decorative techniques, such as faux graining, marbling, stenciling, frescoes, murals, and painted friezes frequently involved the use of lead-based paints.

III. Standards for the Treatment of Historic Properties

The Secretary of the Interior is responsible for establishing standards for the preservation and protection of cultural resources. The Secretary of the Interior’s “Standards for the Treatment of Historic Properties”

(36 CFR Part 68) were initially developed in 1975 and most recently revised in 1992 (they are accessible from <http://www.fdsys.gov> by searching for "36 CFR Part 68"). The Standards advise that significant historic features and materials should be repaired rather than replaced, and that when replacement is necessary, it should be done in kind, i.e. with the same material, design, dimension, etc. The standards, along with guidelines for implementing them, are in the Secretary of the Interior's Standards for the Treatment of Historic Properties with Guidelines for Preserving, Rehabilitating, Restoring & Reconstructing Historic Buildings (2001) (<http://www.nps.gov/history/hps/tps/standguide/>).

The Secretary of the Interior supplemented those standards with Preservation Brief 37, "Appropriate Methods for Reducing Lead-Paint Hazards in Housing" (2006) (<http://www.nps.gov/hps/tps/briefs/brief37.htm>). (The full set of Preservation Briefs can be found at <http://www.nps.gov/tps/how-to-preserve/briefs.htm>.) The Standards guide owners of historic buildings who are undertaking rehabilitation, restoration, preservation, and reconstruction of historic properties. In addition, the Standards are used by the SHPO and the ACHP to evaluate the impact of physical treatments on historic resources in federally assisted projects.

The National Park Service has also developed "Illustrated Guidelines for Rehabilitating Historic Properties" (<http://www.nps.gov/tps/standards/rehabilitation/rehab/index.htm>). The "Illustrated Guidelines" pertain to historic buildings of all sizes, materials, occupancy, and construction types; they apply to interior and exterior work as well as new exterior additions. Those approaches, treatments, and techniques that are consistent with the Secretary of the Interior's "Standards for Rehabilitation" are listed as "Recommended" in each topic area; those approaches, treatments, and techniques which could adversely affect a building's historic character are listed as "Not Recommended" in each topic area.

When working with historic properties, significant spaces, finishes, and features must be identified and priorities for preservation must be set. This applies to both exteriors and period interiors. The goal is to retain as much of the original historic material and features as possible and to preserve the historic character of the resource.

There may be cases when certain proposed abatement treatments are inconsistent with the Standards for the Treatment of Historic Properties. Removal of historically significant architectural features and finishes that have been previously painted with lead-based paint may result in loss of significant historic materials. Abrasive or chemical paint removal methods may disfigure or destroy evidence of significant craftsmanship. Replacement or enclosure of historic wooden siding with modern cement board, vinyl or aluminum siding may damage historic materials and diminish the architectural integrity of the historic resource. Complete removal of paint from substrates can result in the total loss of paint chronology or important evidence of previous decorative paint finishes and colors for properties of great historic significance.

In historic properties, preservation of the component is preferred and the lead hazard control professional and the construction contractor should strive to find solutions that preserve historical features and control lead hazards. Replacement or alteration of components for the sake of lead hazard control is unnecessary when a less aggressive method of controlling the lead hazard is allowable. While there is no simple method for determining which treatment method may be more or less damaging, the anticipated impact of each lead hazard control method on the hazardous building component should be assessed before a particular approach is selected. (See Sections VI and VII below.)

Factors to be considered when evaluating anticipated impact include: significance of the building component affected; number and thickness of paint layers; physical condition of the component; interior or exterior location on the property; skill level of lead hazard control or historic preservation contractor personnel; and environmental conditions.

In affected properties, if the SHPO requests the exemption, the Lead Safe Housing Rule exempts historic properties (those listed or determined eligible for listing in the National Register or contributing to a National Register Historic District) from normally-required abatement of lead-based paint or lead-based

paint hazards and allows interim controls to be performed (24 CFR 35.115(a)(13)). Normally, this exemption is taken when abatement of hazards is required in historic properties receiving greater than \$25,000 per unit in federal rehabilitation assistance, or when historic conventional public housing is being modernized. (See Appendix 6.)

If interim controls are conducted in housing receiving federal housing or rehabilitation assistance, they must be performed in accordance with the Lead Safe Housing Rule at 24 CFR 35.1330 and Chapter 11. If no such assistance is provided, the guidance in Chapter 11 should be used. Ongoing lead-based paint maintenance is required if there is an ongoing relationship between HUD and the property owner; see 24 CFR 35.1335(a) and Chapter 6. If no such assistance is provided, the guidance in Chapter 6 should be followed. HUD program participants should consult their program's regulations and/or Lead Safe Housing Rule and related technical guidance for more information. (See Appendix 6.)

An additional resource for HUD Community Planning and Development (CPD) field staff, grantees and program participants is the CPD Monitoring Handbook Attachment 24-2, Historic Properties and the Lead Safe Housing Rule (go to the CPD website, <http://www.hud.gov/cpd>, click on the link to the CPD Monitoring Handbook, then the link to chapter 24, Lead Hazards, and then the link to the attachment.)

Although some Public Housing Agencies (PHAs) have historic properties in their inventories, this is not as common as the rehabilitation example. PHAs and contractors / organizations supporting them should use the HUD Office of Public and Indian Housing (PIH) memorandum, "PIH Guidance on the Lead-Safe Housing Rule and Lead Disclosure Rule for Field Office Staff," (<http://www.hud.gov/offices/adm/hudclips/guidebooks/PIH-2007-101/PIH-2007-101GUID.doc>) (February 22, 2008) for general lead safety guidance. They may use the CPD Monitoring Handbook Attachment on Historic Properties, above, as guidance for these properties, adapting its use to the PIH program and regulatory environment.

IV. Property Evaluation

A. Evaluating the Significance of a Property

It is the responsibility of a Federal agency or the recipient of its housing assistance funding to identify the architectural significance of a dwelling *before* undertaking work that might affect the historic resource. The responsible entity may need to enlist an architectural specialist to assist in this effort. (Qualified historical architects and preservation specialists can be found through the State Historic Preservation Office.) The National Park Service's National Register of Historic Places Nomination Forms (<http://www.cr.nps.gov/nr/publications/forms.htm>) or the corresponding State forms are often a tool to use to identify significant character-defining features. (As the National Register webpage notes, individuals should contact their SHPO before downloading or completing the National Register forms. Contact information for the SHPOs is at <http://www.cr.nps.gov/nr/shpolist.htm>.)

If a building is over 50 years old, and not listed or evaluated for listing on the National Register, it must be evaluated (for historic significance as well as potential to cause effect) prior to project implementation. The Section 106 review applies to buildings that are listed on or eligible for the National Register of Historic Places.



FIGURE 18.1 Delicate muntins and multi-pane sash on early 19th century row houses. Photo Courtesy National Park Service.

The quality of a building’s architecture and craftsmanship must be considered when evaluating the significance of a property. Buildings that exhibit distinctive characteristics of architectural design represent work by skilled craftsmen, or have high artistic value may require a greater sensitivity on the part of a responsible entity when undertaking alterations or modifications to that structure (see Figure 18.1). Worker housing in an industrial mill town was often constructed with heavy timber post and beam construction or balloon frame wooden systems, but may have very simple decorative or trim work on the interior. The significance of these properties is more closely tied to social movements within our cultural history than to architectural design. A property designed by a prominent architect using master craftsmen and artistic painters will be noted for its architectural appearance and design.

Responsible entities should identify the character-defining features that render the property eligible for the National Register, in order to prioritize the preservation of significant interior and exterior elements. The exterior may contain significant materials such as painted siding, shutters, decorative cornice brackets, porches, and dormers. While the exterior may contain a building’s most prominent features, the interior may also be important in conveying the building’s history. Important interior architectural features may include window trim, doors and door trim, staircases, fireplace mantels, built-in book cases

and cabinets, decorative radiators, picture and chair rails, crown molding, baseboards, mantels, ceiling medallions and coffers, and wood wainscoting in corridors. Architectural finishes of note may include grained woodwork, marbled columns, and plastered walls.

For each historic property, some elements will be of greater significance than others. As part of a survey of each historic property, the responsible entity should identify the elements that could be altered or removed without harming the integrity of the historic resource (e.g., plain plaster surfaces, simple board trim with no distinctive features, and non-historic intrusions, such as replacement windows). Generally, the front facades of buildings will be more significant than the less visible side and rear elevations. Public spaces on the first floor, such as the entrance area and main staircase, will generally be more significant than private spaces, such as the bedroom, kitchen, and bath. This information will be important when decisions are made about where to perform interim controls and where abatement or encapsulation is appropriate.



FIGURE 18.2 Historic properties should have a window condition assessment preceding work. Photo Courtesy National Park Service.

Identifying, retaining, and preserving windows – and their functional and decorative features – is an important step in preserving the overall historic character of the building. Such features can include frames, sash, muntins, glazing, sills, heads, hoodmolds, paneled or decorated jambs and moldings, and interior and exterior shutters and blinds. An in-depth survey of the interior and exterior features and condition of existing windows will provide the basis for evaluating possible rehabilitation or replacement options to make the windows lead-safe. The exterior portion of a window assessment is shown in Figure 18.2.

B. Risk Assessment/Paint Inspection

As with all lead-based paint evaluations, the responsible entity is also responsible for hiring a certified professional to evaluate lead hazards in the dwelling. Because of the need for special care around historic components, the advice of a risk assessor is very helpful when developing a lead hazard control plan. At the same time, any surfaces of historic significance that have been painted should be tested for the presence of lead as part of the evaluation of the dwelling. Ideally, a combination risk assessment/paint inspection should be conducted in historic buildings. At a minimum, the risk assessor should perform x-ray fluorescence (XRF) tests on significant features so that the integrity of the elements is not damaged. Paint chip samples are discouraged in historic properties. However, when laboratory tests are required as a follow up to XRF testing, paint chips should be collected from inconspicuous locations. For properties of great historical significance, significant surfaces found to contain lead-based paint may benefit from additional laboratory analysis to determine the history of each colored layer (chromochronology). The purpose is to provide information on original colors should the property ever be restored (see Chapter 5 for more detail on risk assessments and Chapter 7 on lead-based paint inspections).

V. Establishing Priorities for Intervention

In the absence of a lead-based paint evaluation, priorities for intervention should focus on areas where lead hazards may exist, such as areas of deteriorated paint and abrading friction surfaces of windows, doors and stairs. **The mere presence of lead paint on a building component does not constitute a hazard.**

The significance of historic elements also affects priorities for intervention. (Figure 18.3.) Historic components should be treated with great care when physical intervention is considered as part of a lead hazard control plan. If the element is extremely significant (e.g., a carved mantel) and is in good condition, it should be disturbed as little as possible while still ensuring that lead hazards will be controlled. In this case interim controls are generally preferred (see Chapter 11). If the element is not particularly significant (e.g., a simple baseboard) and is in poor condition, then it may be acceptable to remove the entire feature and replace it with a duplicate or similar baseboard. If the element is significant, but in deteriorated condition, then preservation measures should ensure that in the process of rebuilding or repairing the element, it is not further damaged. Careful paint removal and thorough cleaning of substrates is very time consuming, but may be appropriate for highly significant elements.

VI. Selecting Interim Controls or Abatement

Interim controls are generally less aggressive than abatement techniques. They include paint stabilization with correction of substrate defects, specialized cleaning, temporary repairs, management and resident education programs, and ongoing LBP maintenance. Paint stabilization, an interim control that



FIGURES 18.3a and 18.3b

Historic property before and after rehabilitation.

allows intact historic paint to remain in place (with topcoat of lead-free paint) is the least damaging treatment to an element. Stabilized surfaces will, however, have to be properly maintained. Records should be kept documenting the presence of lead underneath the new paint so that workers will use the proper protective methods during renovations or repair. Residents should be instructed to notify the owner or property manager whenever paint deterioration is detected.

Because of its finality, some HUD program participants may consider abatement (such as component replacement) as the only acceptable approach to lead hazard reduction. Others view the cost-effectiveness of component replacement as adequate justification for this approach. However, as discussed above, at the SHPO's request, a HUD program participant is allowed to use interim controls instead of abatement on interior and exterior surfaces when abatement is otherwise required by the Lead Safe Housing Rule. In these cases, the use of interim controls with ongoing lead-based paint maintenance rather than abatement should be given serious consideration.

HUD recommends that all lead-based paint professionals and housing agencies should consider interim controls on historic properties instead of abatement if feasible and permissible. For historic properties, interim controls are preferred because they preserve the original structure and are usually less costly. In some cases, however, interim controls are not technically feasible or the condition of the affected building components is poor, which makes interim controls impractical. In all cases, decision-makers should justify and be able to document their position.

Lead hazard control professionals or housing agency personnel who insist on abatement as a lead hazard control strategy should review this position with the SHPO to determine its appropriateness in light of two factors:

- ◆ Costs: The generally higher initial costs of abatement relative to interim controls vs. the lower costs of ongoing maintenance after abatement; and,
- ◆ Permanence: The possible irreparable damage to a historical property caused by building component removal or inappropriate alteration or encapsulation.

VII. Selecting Abatement Methods Other Than Paint Stabilization

A. Paint Removal

Recommended paint removal techniques for historic materials include:

- ◆ Wet sanding of loose paint to bonded paint.
- ◆ Finish sanding using mechanical sanders with high-efficiency particulate air (HEPA) vacuum.
- ◆ Low-heat stripping with heat guns or heat plates (less than 450°F, round-edge scraper).
- ◆ Solvent-based non-toxic, non-caustic stripper in place (e.g., not methylene chloride).

Caution should be used with stripping with heat, chemicals, or cold-tank dipping. Chemical stripping processes may melt glued joints, thus damaging the element or at least requiring further repair.

The following techniques are not recommended for paint removal from building components of historic properties because of possible irreparable damage to the components:

- ◆ Caustic strippers that can raise wood grain (unless supervised by a trained specialist).
- ◆ Power sanding that can abrade wood surfaces.
- ◆ Hot-tank dipping that may loosen glued joints.

On-site: The removal of lead-based paint down to the substrate, if carefully done, is the second least invasive treatment. Chemical stripping, wet sanding, or low-heat removal of paint allows the substrate to stay intact and remain in place (see Figure 18.4). However, these methods are time-consuming, and haphazard wet scraping or sanding may abrade delicate substrate finishes. Sometimes, the removal of paint along friction surfaces is an appropriate interim control when the intent of such work is not lead hazard control but operational repair or rehabilitation. The removal of paint along the friction surfaces of historic wood windows is often combined with installation of jamb liners to reduce abrasion concerns, and metal panning in window wells to create an easily cleanable surface.

Several paint removal techniques are prohibited in HUD-assisted properties, and/or by EPA for renovation (which is broadly defined; see the Glossary) or abatement.

- ◆ Techniques prohibited by HUD and by EPA for renovation and abatement are:
 - Open flame burning or torching.
 - Machine sanding or grinding without a HEPA local exhaust control (containment).
 - Abrasive (e.g., wet grit) blasting or sandblasting without HEPA local exhaust control containment.
 - Heat guns operating at or above 1100 degrees Fahrenheit or charring the paint.
- ◆ Additional paint removal techniques prohibited in HUD-assisted properties, and by EPA for abatement, are:
 - Dry sanding or dry scraping (except dry scraping in conjunction with heat guns or around electrical outlets, or when treating defective paint spots totaling no more than 2 square feet in any one interior room or space, or totaling no more than 20 square feet on exterior surfaces).
- ◆ An additional paint removal technique prohibited in HUD-assisted properties is:
 - Paint stripping in a poorly ventilated space using a volatile stripper that is a hazardous substance in accordance with regulations of the Consumer Product Safety Commission at 16 CFR 1500.3, and/or a hazardous chemical in accordance with the Occupational Safety and Health Administration regulations at 29 CFR 1910.1200 or 1926.59, as applicable to the work. (The most common HUD-prohibited stripper is methylene chloride.)



FIGURE 18.4 Wood features on historic properties. Sometimes they can be stabilized instead of stripped of traditional painted finish as in this photo. Photo courtesy of National Park Service.



FIGURE 18.5a and 18.5b

Doors to historic property before and after off-site stripping.

Off-Site: A potentially more damaging paint removal treatment involves the removal of items for off-site stripping. Only companies experienced in treating historic building parts should be used to conduct paint stripping. If the items are easily removed (e.g., doors, shutters, or windows), they can be carefully treated off-site and then reinstalled. (See Figure 18.5). Caution is advised when considering this method because trim, mantels, banisters, newel posts, or other carved elements constructed in sections may be firmly attached and may be damaged when removed, thus requiring repair or reconstruction. Hardware should be removed and labeled before paint is removed.

Rough treatment by gouging, splitting, nail holes, and crowbar marks take their toll on the materials and are to be avoided. The creation of leaded dust generally accompanies the removal of attached trim work.. It should be

noted that in the process of dipping, glue joints may loosen or come apart and may need repair. Too often, particularly for wooden elements, surfaces are gouged or grain is raised in an overly aggressive approach to paint removal.

However, if care is taken during preparation, removal and reinstallation, damage can be minimized and the benefits of this method may outweigh the alternative loss of historic components. If elements deteriorate during the paint removal process, repairs or replacement of significant components should match the originals in size, material, and configuration. Less significant features should match the visual appearance as closely as possible.

In homes of great historic significance, it may be important to document evidence of initial construction and subsequent alterations that can be found in paint layering on historic substrates (see discussion of chromochronology in Section IV.B, above). Unless paint analysis is performed prior to paint removal, this evidence will be lost. By comparing paint layers from one portion of the housing unit or room to another, a list of dates and known changes can be recorded. The relocation of significant elements, such as mantels, from one room to another can often be detected by comparing paint layers. The original colors of these elements can also be determined by evaluating samples of paint under a microscope with correcting light filters.

B. Component Removal and Replacement

If significant elements are in poor condition and too deteriorated to withstand paint removal, it may be possible to replace these elements with matching new elements without threatening the historic integrity of the element or building. This is particularly applicable to simple double-hung historic wooden window sashes in poor condition. On readily visible building elevations, such as the front and often typically the side, windows usually are identified as significant elements of the building. In such cases, replacement windows should be wood and should match as closely as

possible the size, configuration, sash, mullion and muntin profile, pane configuration, and other visual qualities of the historic windows. Replacement of too many significant features of a building, however, may jeopardize the historic integrity of the resource. For this reason only seriously deteriorated or unsalvageable materials should be replaced.

Complete removal of painted features and the failure to replace or replicate them is extremely damaging to the historic resource. Proper maintenance is especially important in historic properties containing lead-based paint to avoid the creation of new hazards. For example, if bathroom leaks or other moisture sources deteriorate painted surfaces, paint chips or lead-contaminated dust could become a significant hazard. Residents should be advised to clean their dwellings and notify their building managers if deterioration occurs.

C. Encapsulation

Encapsulating coatings, rigid encapsulant claddings, and wall enclosures affect historic resources in different ways. Depending on the overall visual effect of the resource, the long-term objectives of a preservation project, and the environmental climate of the resource, there will be differing degrees of success. For example, the use of an approved wall lining and skimcoating encapsulating system over deteriorated plaster with a finish coat of paint may be appropriate in a simple interior. However, encapsulating paint coatings over decorative moldings would not be appropriate due to the viscous nature of the coating and the loss of the decorative wood detailing. The use of encapsulant coatings on exteriors of historic wooden buildings in moist or humid areas can have damaging long-term effects. Because the thickness of exterior coatings range from 10 to 14 mil, substrates may deteriorate because of moisture trapped behind the coating.



FIGURE 18.6 Enclosure of stairs in this manner is generally not appropriate in a historic property.

D. Enclosures

Enclosing a decorative feature may be appropriate if doing so does not damage the structure beyond a minimal amount (see Figure 18.6). For example, a projecting mantel might be enclosed if the fireplace is not to be used in the interim, and the decorative finishes are to be enclosed behind drywall finishes. While this is a serious loss of historic character, if it is a temporary solution and no harm is done to the feature, it might be an appropriate treatment. The use of artificial siding over painted and otherwise sound historic exteriors often results in a removal of projecting historic elements, such as roof brackets, and conceals the historic trim. The use of these artificial sidings is not recommended.

VIII. Conclusions

There are different levels of historic treatments appropriate to different levels of building significance and condition. Controlling lead hazards in historic

buildings is a balancing act between several important objectives: childhood health, economic feasibility, and historic preservation. For instance, abatement methods that permanently reduce lead hazards may have a more negative effect on the character of a historically significant home than interim controls. For homes of great historic significance, removing historic paint layers and their substrates can result in an irretrievable loss of materials and craftsmanship. Interim controls are more suitable as a long-term solution as long as the historic property is maintained in good condition. As deteriorated elements are repaired or replaced, much of the lead-based paint can be removed with appropriate methods. Retention of the maximum amount of historic material as possible is the goal, while providing a lead-safe housing unit.

IX. Historic Preservation Project Case Study

A group of 1890s row houses is part of a National Register Historic District noted for its Victorian architecture. This group of low-to-moderate income rental units used a variety of Federal and State funding sources, including HUD CDBG Block Grants to the local Housing and Community Development Agency to fund the rehabilitation. The buildings in the group are mostly 3-story brick construction, with side hall plans. There is a Memorandum of Agreement (MOA) among the City, the SHPO, and the ACHP that the rehabilitation of these buildings would conform to the Secretary of the Interior's Standards for the Treatment of Historic Properties (1992). After receiving the evaluation report, the City consulted with the SHPO about the proposed cladding of the windows, and opted for replacing the sash and stabilizing the original frames.

A. Historic Significance:

The significance of each building in the project was established with the assistance of the SHPO. Both the exterior front facade with its distinctive mansard roof, as well as the interior with its traditional plan and period woodwork were significant. Individual features identified for preservation on the interior included an ornate staircase and banister, period woodwork, and trim around windows and doorways, and decorative ceiling medallions. The windows were wooden double-hung units with a curved top with simple large panes of glass in a one over one configuration; the exterior frames had a distinctive bull-nose molding. Roof leaks made many upper floor ceilings structurally unsound. Less architecturally detailed areas were the bathrooms, the kitchen, and rear additions.

B. LBP Evaluation:

- ◆ The City estimated the planned rehabilitation of the properties to average \$11,000 (excluding lead hazard evaluation and control costs) per unit, which was greater than \$5,000 but not more than \$25,000 per unit. As a result, the Lead Safe Housing Rule required a risk assessment and allowed interim controls (rather than abatement) to be conducted.
- ◆ Although the evaluation requirement for this level of rehabilitation assistance in HUD's Lead Safe Housing Rule was a risk assessment, the local Housing and Community Development Agency contracted with a certified lead-based paint inspector/risk assessor to perform a combined lead-based paint inspection and risk assessment in order to scope the project more fully and minimize unnecessary lead hazard control costs. This evaluation contract included preparing the evaluation report for use in scoping the lead hazard control work, and preparing the notice of evaluation to occupants.
- ◆ The property was tested for the presence of both lead-based paint and lead-based paint hazards, including lead-contaminated dust and bare soil. The paint inspection indicated that there was lead-based paint on the painted exterior brick, exterior windows, and all wooden

trim and features inside and on glossy painted wall surfaces inside, such as the kitchen and bathrooms. The overall condition of the paint was deteriorated, and many plaster surfaces were water damaged, but the wooden trim underneath the paint was sound. The windows were in poor condition. Some dust-lead levels were hazardous, including dust underneath the window sills in the kitchen and bathrooms. Soil-lead levels were below the hazard level.

- ◆ The notice of evaluation summarized the nature, dates, scope and results of the inspection and risk assessment; provided a contact name, address and telephone number for more information and for obtaining access to the actual evaluation report; and gave the date of the notice. Three days after receiving the evaluation report and the notice to occupants (well within the 15 days allowed), the Agency notified the families in each row house of the results by distributing the notice to each occupied unit.

C. Lead hazard control:

In consultation with the non-profit organization that was rehabilitating the property, the Housing and Community Development Agency established a lead hazard control plan as part of the building rehabilitation effort. As noted, the Lead Safe Housing Rule required that all lead hazards on the property be controlled by interim controls at a minimum. The basic building plan configuration was retained with an upgrade of mechanical and electrical services. Most of the deteriorated paint was stabilized by wet scraping and careful wet sanding followed by repainting.

- ◆ Exterior: The exterior was stabilized by wet scraping to remove flaking paint and was repainted with a primer and exterior oil/alkyd paint.
- ◆ Wall surfaces: Each room and hallway received new ceilings of drywall to replace water damaged and deteriorated plaster ceilings. Most plaster walls were repaired and repainted, but the kitchen and bathroom walls and ceilings, which contained large amounts of deteriorated lead-based paint on water-damaged plaster, were replaced with new drywall.
- ◆ Interior trim: All historic wooden trim remained in place and was stabilized after wet sanding to remove loose lead-based paint. The ornate banisters and handrails that had potentially chewable surfaces, were stripped off-site, then reinstalled. The ceiling medallions were removed and reinstalled after cleaning.
- ◆ Windows: The window sashes were replaced with new sash matching the visual configuration of the historic sash, which included an arched upper portion. The historic frames remained in place and received vinyl jamb liners to eliminate friction surfaces. The project was scheduled to have the window frames on the exterior boxed out and clad in white aluminum, but this treatment was eliminated after consultation with the SHPO because it would have altered a significant architectural feature on the primary facade. To preserve the distinctive bull-nose moldings of these exterior frames, it was determined that the wood could either be wet sanded or chemically stripped to remove paint and repainted with oil/alkyd paint. Repainting with oil/alkyd after a mild chemical cleaning was selected for the exterior frames.

D. The scope of the work:

- ◆ The scope of rehabilitation work outlined by the Housing and Community Development Agency adhered to the Secretary of the Interior's Standards because it preserved the significant features of the building and provided for replacement in-kind or with compatible materials which

replicated the historic appearance of the deteriorated originals. Had any of the above treatments called for removal or substantial alteration of significant features, the rehabilitation would have resulted in an adverse effect, requiring the city to obtain the Advisory Council's comments.

- ◆ The Agency's contract for the rehabilitation work specified that the firm had to be a certified renovation firm (under EPA authorization, the State operated the certification program) and that the workers and project supervisor had to be certified renovators (as required by HUD's Lead Safe Housing Rule, building on the EPA's Renovation, Repair, and Painting (RRP) Rule).
- ◆ The Agency also contracted with the original lead-based paint inspector/risk assessor to perform the clearance examination after the lead hazard control work was completed. This contract also included preparing the clearance report and the notice of hazard reduction activity to occupants.
- ◆ Because the project was to last longer than 5 days in each building (with the work being conducted, for the sake of efficiency, at the same time in all units and the hallways in a building), the occupants were temporarily relocated to lead-safe housing elsewhere in the Historic District.

E. Project completion:

- ◆ The renovation contractor informed the inspector/risk assessor when the work was to be examined for clearance of each row house, and the inspector/risk assessor conducted the clearance examination in all of the units and the hallways in that building. In some buildings, some units and hallways did not pass clearance the first time, so the contractor re-cleaned the failed components and similar untested components. In those units and hallways, the inspector/risk assessor conducted another clearance examination, and determined that the project passed clearance. (Had any of the re-clearances failed, the failed components and similar untested components in those units would have had to be re-cleaned again and re-cleared, with the cycle repeated until successful. The contractor could have decided to do further lead hazard control work before re-cleaning, in an effort to minimize the number of cleaning / clearance cycles.)
- ◆ Two days after the lead hazard control work was completed (well within the 15 days allowed), the Housing and Community Development Agency provided the notice of hazard reduction activity to the occupants who were returning to each row house. The notice summarized the nature, dates, scope and results (including clearance examination results) of the hazard reduction work; gave a contact name, address, and telephone number for more information; gave the available surface-by-surface information on where the remaining lead-based paint was in units and hallways where lead hazard work had been conducted; and gave the date of the hazard control notice itself.
- ◆ The Agency also provided the returning occupants with instructions on how to maintain a lead-safe home, stressing the importance of using lead-safe methods to keep their housing units free of dust and dirt that might contain lead, with particular information on helping protect the historic character of the housing, and provided contact information if occupants had questions or wanted to report deterioration or damage to the housing.
- ◆ The Agency provided disclosure under the Lead Disclosure Rule to prospective tenants looking to move into units vacated by those occupants who had decided to use the occasion of the project to move elsewhere. Information on the inspection, risk assessment, scope of the project's lead hazard control work, and clearance results were part of the disclosure, along with the Lead Warning Statement and other reports, records and knowledge disclosed, as discussed in Appendix 6.

Glossary

Notes:

- ◆ These definitions are for use within the scope of these *Guidelines*, that is, for lead-based paint hazard evaluation and control, and are not necessarily generic definitions applicable outside of this scope.
- ◆ For Federal regulatory definitions, please see:
 - CPSC’s Lead-Containing Paint regulation (16 CFR 1303);
 - EPA’s Lead-Based Paint Abatement; Renovation, Repair and Painting; and Pre-Renovation Education regulations (40 CFR Part 745);
 - HUD’s Lead Disclosure Rule and Lead Safe Housing Rule (24 CFR Part 35); and
 - OSHA’s Lead in Construction standard (29 CFR 1926.62).

AAALA: American Association for Laboratory Accreditation. Also known as **A2LA**.

Abatement: A measure or set of measures designed to permanently eliminate lead-based paint hazards or lead-based paint. Abatement strategies include the removal of lead-based paint, enclosure, encapsulation, replacement of building components coated with lead-based paint, removal of lead-contaminated dust, and removal of lead-contaminated soil or overlaying of soil with a durable covering such as asphalt (grass and sod are considered interim control measures). All of these strategies require preparation; cleanup; waste disposal; post-abatement clearance testing; recordkeeping; and, if applicable, monitoring. (For full EPA definition, see 40 CFR 745.223). See, also, **Interim controls**.

Abrasion resistance: Resistance of the paint to wear by rubbing or friction; related to both toughness and gloss.

Accreditation: A formal recognition that an organization, such as a training provider, is competent to carry out specific tasks or types of tests.

Accredited training provider: A training provider who meets the standards established by EPA (or an EPA-authorized State or Tribe) for the training of risk assessors, inspectors, abatement supervisors, abatement workers, renovators, and dust sampling technicians.

Accuracy: The degree of agreement between an observed value and an accepted reference value (a “true” value); a data quality indicator. Accuracy includes a combination of random errors (precision) and systematic errors (bias) due to sampling and analysis. See also the related, but different, term **Precision**.

Acrylic: A synthetic resin used in high performance waterborne coatings; a coating whose binder contains acrylic resins.

Adhesion: The ability of dry paint or other coating to attach to a surface and remain fixed on it without blistering, flaking, cracking, or being susceptible to removal by tape.

Administrative removal: The temporary removal of workers from the job to prevent the concentration of lead in their blood from reaching levels requiring medical removal.

AIHA: American Industrial Hygiene Association.

ALC: see **Apparent Lead Concentration**.

Aliquot: see **Subsample**.

Alkali: A chemical, such as lye, soda, lime, etc., that will neutralize an acid. Oil paint films can be destroyed by alkalis. Some paint removal products contain alkaline substances.

Alkyd: Synthetic resin modified with oil; coating that contains alkyd resins in the binder.

Apparent Lead Concentration (ALC): The x-ray fluorescence (XRF) reading or average of more than one reading on a painted surface. See also **XRF analyzer**, **Substrate Equivalent Lead (SEL)**, and **Corrected Lead Concentration (CLC)**.

Arithmetic mean: Average.

Bare soil: Soil not covered with grass, sod, some other similar vegetation, or paving, including the sand in sandboxes.

Bias: A systematic error in the measurement process. For XRF readings, one source of bias is the substrate effect. See also **Substrate effect** and **XRF analyzer**.

Binder: Solid ingredients in a coating that hold the pigment particles in suspension and bind them to the substrate. Binders used in paints and coatings include oil, alkyd, acrylic, latex, and epoxy. The nature and amount of binder determines many of the coating's performance properties – wash ability, toughness, adhesion, gloss, etc. See, also, **Pigment**.

Biological monitoring: The analysis of blood, urine, or both to determine the level of lead contamination in the body. Blood lead levels are expressed in micrograms of lead per deciliter (one-tenth of a liter) of blood, or $\mu\text{g}/\text{dL}$. They are also expressed in micromoles per liter ($\mu\text{mol}/\text{L}$).

Blank: An unexposed sample of the medium being used for testing (i.e., wipe or filter) that is analyzed to determine if the medium has been contaminated with lead (e.g., at the factory or during transport).

Blind sample: A sample submitted for analysis that has a known composition and identity that is not known to the analyst; used to test the analyst's or laboratory's proficiency in conducting measurements. See, also, the related term **Spiked sample**.

Building component: Any element of a building that may be painted or have dust on its surface, e.g., walls, stair treads, floors, railings, doors, windowsills, etc.

Building component replacement: see **Replacement**.

Cementitious material: A material that is mixed with water, either with or without aggregate, to provide the plasticity, cohesion, and adhesion necessary for the placement and formation of a rigid mass (ASTM Standard C 11).

Centimeter: see **cm**.

Certification: The process of testing and evaluating against certain specifications the competence of a person, organization, or other entity in performing a function or service, usually for a specified period of time.

Certified: The designation for contractors who have completed training and other requirements to allow them to safely undertake risk assessments, inspections, abatement or renovation. Risk assessors, inspectors, abatement contractors and renovation contractors should be certified (and licensed, if applicable) by the appropriate local, State or Federal agency.

Certified Industrial Hygienist (CIH): A person who has passed the 2-day certification exam of the American Board of Industrial Hygiene, and who has at least 4 years of experience in industrial hygiene and a graduate degree or a total of 5 years of experience. See, also, **Industrial hygienist**.

Certified reference material (CRM): Reference material that has at least one of its property values established by a technically valid procedure and is accompanied by or traceable to a certificate or other documentation issued by a certifying body. See, also, **Standard reference material**.

Certified Renovator: An individual who has successfully completed a renovator course accredited by EPA or an EPA-authorized State or Tribal program.

CFR: see **Code of Federal Regulations**.

Chalking: The photo-oxidation of paint binders - usually due to weathering - that causes a powder to form on the film surface.

Chewable surface: An interior or exterior surface painted with lead-based paint that a young child can mouth or chew. A chewable surface is the same as an "accessible surface" as defined in 42 U.S.C. 4851b(2). Hard metal substrates and other materials that cannot be dented by the bite of a young child are not considered chewable.

Chewed surface: Any painted surface that shows evidence of having been chewed or mouthed by a young child. A chewed surface is usually a protruding, horizontal part of a building, such as an interior windowsill. See, also, **Chewable surface**.

CLC: see **Corrected Lead Concentration (CLC)**

Cleaning: The process of using a vacuum and wet cleaning agents to remove leaded dust; the process includes the removal of bulk debris from the work area.

Cleaning Verification: The procedure required by EPA under its Renovation, Repair and Painting regulation after most renovations that disturb known or presumed lead-based paint. A certified renovator must perform a visual inspection to determine whether dust, debris or residue is still present. If so, these must be removed by re-cleaning and another visual inspection must be performed. After a successful visual inspection, the certified renovator must verify that each windowsill, uncarpeted floor and countertop in the work area has been adequately cleaned by wiping them with wet disposable cleaning cloths that are damp to the touch. If a cloth matches or is lighter than an EPA cleaning verification card, the surface passes; if not, it has to be recleaned and reverified. For more details, see Appendix 6 and 40 CFR 745.85(b).

Clearance examination: Visual examination and collection of lead dust samples by an inspector or risk assessor, or, in some circumstances, a sampling technician, and analysis by a EPA-recognized laboratory upon completion of an abatement project, interim control intervention, maintenance or renovation job that disturbs lead-based paint (or paint presumed to be lead-based.) For abatement projects, the clearance examination is performed to ensure that lead exposure levels do not exceed clearance standards established by the EPA at 40 CFR 745.227(e) (8)(viii); HUD's dust-lead standards for clearance after interim control projects are found at 24 CFR 35.1320(b)(2)(i).

Clearance examiner: A person who conducts clearance examinations following lead-based paint hazard control and cleanup work, usually a certified risk assessor, certified inspector or sampling technician.

cm: Centimeter; 1/100 of a meter.

Code of Federal Regulations (CFR): The codification of the regulations of Federal agencies. The regulations are published in the *Federal Register*. See, also, **Federal Register (FR)**.

Cohesion: Ability of a substance to adhere to itself; internal adhesion; the force holding a substance together.

Common area: A room or area that is accessible to residents of more than one dwelling unit (e.g., hallways or lobbies); in general, any area not kept locked.

Competent person: As defined in the OSHA Lead Construction Standard (29 CFR 1926.62), a person who is capable of identifying or predicting hazardous working conditions and work areas, and who has authorization to take prompt, corrective measures to eliminate the hazards. A competent person may also be a risk assessor, inspector, abatement project supervisor or certified renovator; however, certification on its own does not give a person the authority to take corrective action, which a competent person must have.

Compliance plan: A document that describes the types of tasks, workers, protective measures, and tools and other materials that may be employed in lead-based paint hazard control to comply with the OSHA Lead Exposure in Construction standard.

Composite sample: A single sample made up of individual subsamples. Analysis of a composite sample produces the arithmetic mean of all subsamples.

Construction and Demolition Landfill (C&D): Landfills that only accept waste from construction and demolition activities. Some states and local governments permit residential LBP waste to be accepted as well.

Containment: A process to protect workers and the environment by controlling exposures to the lead-contaminated dust and debris created during abatement, interim controls or lead-safe renovation. See, also, **Worksite preparation level**.

Contingency plan: A document that describes an organized, planned, and coordinated course of action to be taken during any event that threatens human health or the environment, such as a fire, explosion, or the release of hazardous waste or its constituents from a treatment, storage, or disposal facility.

Corrected Lead Concentration (CLC): The absolute difference between the Apparent Lead Concentration and the Substrate Equivalent Lead. See, also, **Apparent Lead Concentration (ALC)** and **Substrate Equivalent Lead (SEL)**.

Deciliter (dL): one tenth of a liter.

Detection limit: The minimum amount of a substance that can be reliably measured by a particular method.

Deteriorated paint: Any paint coating on a damaged or deteriorated surface or fixture, or any interior or exterior lead-based paint that is peeling, chipping, blistering, flaking, worn, chalking, alligating, cracking, or otherwise becoming separated from the substrate.

Digestion blank: A mixture of the reagents used for digesting of paint, soil, or dust matrixes but without the matrix. The blank undergoes all the steps of the analysis, starting with digestion. The blank is used to evaluate the contamination process from a laboratory.

Direct-reading XRF: An analyzer that provides the operator with a display of lead concentrations calculated from the lead K shell X ray intensity without a graphic of the spectrum usually in mg/cm² (milligrams of lead per square centimeter of painted surface area). See, also, **XRF analyzer**.

Disposal (of waste): The discharge, deposit, injection, dumping, spilling, leaking, or placement of solid or liquid waste on land or in water so that none of its constituents can pollute the environment by being emitted into the air or discharged into a body of water, including groundwater.

Disposal facility: A facility or part of one in which waste is placed on land or in water to remain there after the facility closes.

Doormat: see **Walkoff mat**.

Dripline/foundation area: The area within 3 feet out from the building wall and surrounding the perimeter of a building.

Dust-lead hazard: Surface dust in residences that contains an area or mass concentration of lead equal to or in excess of the standard established by the EPA under Title IV of the Toxic Substances Control Act. EPA standards for dust-lead hazards, which are based on wipe samples, are published at 40 CFR 745.65(b); as of the publication of this edition of these *Guidelines*, these are 40 µg/ft² on floors and 250 µg/ft² on interior windowsills. (As of the publication of this edition of these *Guidelines*, in response to a petition received by the EPA on August 10, 2009, HUD and EPA are collaboratively considering whether to lower the dust-lead hazard thresholds.) Also called **Lead-contaminated dust**.

Notes:

- ◆ These *Guidelines*' related recommended standards for lead hazard screens, for which fewer samples are taken than in a risk assessment, are 25 µg/ft² for floors, and 125 µg/ft² for interior windowsills; if the results equal or exceed these levels, these *Guidelines* recommend that a full risk assessment be performed to determine if and where lead-based paint hazards truly exist). (See Chapter 5, especially Section II.I and V.D.)
- ◆ The EPA's related standards for clearance are 40 µg/ft² on floors, 250 µg/ft² on interior windowsills and 400 µg/ft² on window troughs. (40 CFR 745.227(e)(8) (viii))

Dust removal: A form of interim control that involves initial cleaning followed by periodic monitoring and recleaning, as needed. Depending on the severity of lead-based paint hazards, dust removal may be the primary activity or just one element of a broader control effort.

Dust trap: A surface, component, or furnishing that serves as a reservoir where dust can accumulate.

EBL: Elevated blood lead level as defined by the Centers for Disease Control and Prevention. Local standards may differ. In 2012, the CDC revised its definition to use a "reference value" of the blood lead level at the 97.5th percentile of children aged 1 to 5 years old based on its National Health and Nutrition Examination Survey (NHANES). As of the publication of this edition of these *Guidelines*, the reference level was 5 µg/dL.

EIBLL child: see **Environmental Intervention Blood-Lead Level (EIBLL) child**.

Efflorescence: The salt rising to the surface of a material, such as masonry, plaster, or cement, caused by the movement of water through the material. Paint or encapsulants may not adhere to a surface contaminated with efflorescence.

Elastomeric: A group of pliable, elastic liquid encapsulant coatings. An elastomer is a macromolecular material that, at room temperature, is capable of substantially recovering its size and shape after the force causing its deformation is removed (see ASTM D907, D14).

Environmental Intervention Blood-Lead Level (EIBLL): As defined by HUD in the Lead Safe Housing Rule (24 CFR 35.110) as of the publication of this edition of these *Guidelines*, a blood lead level of a child under age 6 years at or above 20 µg/dL in a single test or at 15-19 µg/dL in two tests taken at least three months apart (). While the term and its definition were based on guidance from the Centers for Disease Control and Prevention, in 2012 CDC revised its guidance, and it is anticipated that those laws and regulations will be reconsidered at some point. See Chapter 16.

Encapsulation: Any covering or coating that acts as a barrier between lead-based paint and the environment, the durability of which relies on adhesion and the integrity of the existing bonds between multiple layers of paint and between the paint and the substrate. See, also, **Enclosure**.

Enclosure: The use of rigid, durable construction materials that are mechanically fastened to the substrate to act as a barrier between the lead-based paint and the environment.

Engineering controls: Measures other than respiratory and other personal protection or administrative controls that are implemented at the worksite to contain, control, and/or otherwise reduce exposure to lead-contaminated dust and debris usually in the occupational health setting. The measures include process and product substitution, isolation, and ventilation. The term may be used in the occupational health setting in regard to preventing workers' exposures to lead; it can also be used in other lead hazard control settings, such as in regard to preventing residents' exposure.

Evaluation: Risk assessment, paint inspection, reevaluation, paint testing, environmental investigation, clearance examination, or risk assessment screen.

Examination: see **Clearance examination**.

Exposure assessment: The employer's sampling and analysis of the air workers breathe to determine the degree of worker exposure to lead by workers in each job classification in each work area. This involves air sampling inside the monitored workers' breathing zones, and comparison of the results to the OSHA Action Level and Permissible Exposure Limit for lead.

Exterior work area: For lead hazard control work, the exterior work area includes any exterior building components, such as roofs, exterior walls, the exterior portions of windows and doors, exterior stairways, fences, and unenclosed porches and patios; the safety perimeter; and access barriers, where work is being done, and the pathways and storage areas used to access those components.

Facility (pertaining to hazardous waste): All buildings, contiguous land, structures, and other appurtenances, as well as any improvements, where lead-based paint or hazardous waste is treated, stored, or disposed. A facility may consist of several different treatment, storage, or disposal units, such as landfills and surface impoundments.

Federal Register (FR): A daily Federal publication that contains proposed and final regulations, rules, and notices.

Field blank: A clean sample of the matrix (e.g., filter, or wipe) that has been exposed to the sampling conditions; returned to the laboratory; and analyzed as an environmental sample. Clean quartz sand, air sampling filters and cassettes, and clean wipes can be used as field blanks. The field blank, which should be treated just like the sample, indicates possible sources of contamination.

FR: see (FR).

Friction surface: Any interior or exterior surface, such as a window or stair tread, subject to abrasion or friction.

Garden area: An area where plants are cultivated for human consumption or for decorative purposes.

Geometric mean: A type of mean or average, which indicates the central tendency or typical value of a set of numbers. It is similar to the arithmetic mean, for which the numbers are added and then one n^{th} (where n is the count of numbers in the set) is found by division, except that, for the geometric mean, the numbers are multiplied and then the n^{th} root (where n is the count of numbers in the set) of the product is taken. For example, for the values 2, 2 and 16, the arithmetic mean is $(2 + 2 + 16) / 3 = 20/3 = 6.6666+$, and the geometric mean is $(2 * 2 * 16)^{1/3} = 64^{1/3} = 4$.

Heat gun: A device capable of heating lead-based paint causing it to separate from the substrate. For lead hazard control work, the heat stream leaving the gun should not exceed 1100°F (some authorities may use a different temperature).

HEPA filter: see **High Efficiency Particulate Air (HEPA) filter**.

High Efficiency Particulate Air (HEPA) filter: A filter capable of removing particles of 0.3 microns or larger from air at 99.97 percent or greater efficiency.

HEPA vacuum: A vacuum cleaner which has been designed with a HEPA filter as the last filtration stage. The vacuum cleaner must be designed so that all the air drawn into the machine is expelled through the HEPA filter with none of the air leaking past it. (Note that HUD's definition in its Lead Safe Housing Rule, with its slightly different wording, is substantively identical.)

Household hazardous waste: Household waste is regular garbage or trash that is disposed of as municipal waste, and managed according to state and local requirements. Waste generated in residential setting. EPA has determined that residents and contractors working in residences are entitled to manage their own LBP waste in this manner.

Impact surface: An interior or exterior surface (such as surfaces on doors) subject to damage by repeated impact or contact.

Incinerator: An enclosed device using controlled flame combustion that neither meets the criteria for classification as a boiler nor is listed as an industrial furnace.

Indian Housing Agency: An agency within an Indian tribal government that receives grants and provides assistance (under the United States Housing Act of 1937) for affordable housing activities for Indians.

Industrial hygienist: A person having a college or university degree in engineering, chemistry, physics, medicine, or a related physical or biological science who, by virtue of special training, is qualified to anticipate, recognize, evaluate, and control environmental and occupational health hazards and the impact of those hazards on the community and workers.

In-place management: see **Interim controls**.

Inspection (of paint): A surface-by-surface investigation to determine the presence of lead-based paint (in some cases including dust and soil sampling) and a report of the results.

Inspector (more formally, Lead-Based Paint Inspector): An individual who has successfully completed training from an accredited program and been licensed or certified by the appropriate State or local agency to:

- (1) perform inspections to determine and report the presence of lead-based paint on a surface-by-surface basis through on-site testing;
- (2) report the findings of such an inspection;
- (3) collect environmental samples for laboratory analysis;
- (4) perform clearance testing; and optionally
- (5) document successful compliance with lead-based paint hazard control requirements or standards.

Interim controls: A set of measures designed to temporarily reduce human exposure or possible exposure to lead-based paint hazards. Such measures include, but are not limited to, specialized cleaning, repairs, maintenance, painting, temporary containment, and the establishment and operation of management and resident education programs. Monitoring, conducted by owners, and reevaluations, conducted by professionals, are integral elements of interim control. Interim controls include dust removal; paint film stabilization; treatment of friction and impact surfaces; installation of soil coverings, such as grass or sod; and land use controls. Interim controls that disturb painted surfaces are renovation activities under EPA's Renovation, Repair and Painting Rule. See, also, **Monitoring, Reevaluation, and Abatement.**

Interior windowsill: The portion of the horizontal window ledge that protrudes into the interior of the room, adjacent to the window sash when the window is closed; often called the window stool.

Investigation (pertaining to EIBLL cases only): The process of determining the source of lead exposure for a child or other resident with an elevated blood lead level. Investigation consists of administration of a questionnaire, comprehensive environmental sampling, case management, and other measures.

Investigator: A person who conducts an investigation of a dwelling where a resident has an environmental intervention blood lead level. The investigator must be proficient in interviewing techniques, environmental sampling, and the interpretation of risk assessment and environmental sampling data.

Laboratory analysis: A determination of a sample by a qualified laboratory using a defined method meeting specified performance and quality criteria. In the case of analysis of samples of lead in paint, dust or soil in target housing or pre-1978 child-occupied facilities, the laboratory must be recognized by NLLAP. Among the methods used by these laboratories for determining lead content are atomic absorption spectroscopy (AAS), inductively coupled plasma emission spectroscopy (ICP), or laboratory-based K or L X-ray fluorescence, or an equivalent method.

Landfill: A State licensed or State permitted disposal facility that meets municipal solid waste standards.

Latex: A waterborne emulsion paint made with synthetic binders, such as 100 percent acrylic, vinyl acrylic, terpolymer, or styrene acrylic; a stable emulsion of polymers and pigment in water.

LBP: Lead-based paint.

Lead: Lead includes metallic lead and inorganic and organic compounds of lead.

Lead-based paint: Any paint, varnish, shellac, or other coating that contains lead equal to or greater than 1.0 mg/cm² as measured by XRF or laboratory analysis, or 0.5 percent by weight (5000 mg/g, 5000 ppm, or 5000 mg/kg) as measured by laboratory analysis. (Local definitions may vary.) (As of the publication of this edition

of these *Guidelines*, in response to a petition received by the EPA on August 10, 2009, HUD and EPA are collaboratively considering whether to lower the threshold levels of lead-based paint.)

Lead-based paint abatement planner/designer: An individual who has completed an accredited training program on planning and designing lead-based paint hazard control projects.

Lead-based paint abatement worker: see **Worker**.

Lead-based paint free: A property where no lead in amounts greater than or equal to 1.0 mg/cm² in paint (or surface coatings) was found on any building components, using the inspection protocol in Chapter 7 of the HUD *Guidelines for the Evaluation and Control of Lead-Based Paint Hazards in Housing* (2012 Revision).

Notes:

- ◆ A lead-based paint-free property may contain lead incorporated into components that are not lead-based painted, such as ceramic tile, or painted components below the standard stated in this definition.
- ◆ Some states and localities have a lower threshold for the definition of lead-based paint.
- ◆ OSHA does not consider whether paint is lead-based paint in its regulations; its regulations focus on whether workers may be exposed to lead whatever the source.

Lead-based paint hazard: A condition in which exposure to lead from lead-contaminated dust, lead-contaminated soil, or deteriorated lead-based paint would have an adverse effect on human health (as established by the EPA at 40 CFR 745.65, under Title IV of the Toxic Substances Control Act). Lead-based paint hazards include, for example, **paint-lead hazards**, **dust-lead hazards**, and **soil-lead hazards**.

Lead-based paint hazard control: Activities intended to control and eliminate lead-based paint hazards, including but not limited to interim controls and abatement.

Lead-based paint inspector or **Lead paint inspector:** see **Inspector**.

Lead-based paint risk assessor: see **Risk Assessor**.

Lead carbonate: A pigment used in some lead-based paints as a hiding agent; also known as white lead.

Lead-contaminated dust: See **Dust-lead hazard**.

Lead-contaminated soil: See **Soil-lead hazard**.

Lead-containing paint: As defined by the Consumer Product Safety Commission, paint or other similar surface coating materials for consumer use that contain lead or lead compounds and in which the lead content (calculated as lead metal) is in excess of 0.009 percent by weight of the total nonvolatile content of the paint or the weight of the dried paint film (see 16 CFR 1303.1(c)).

Lead hazard screen: A method of determining, in buildings in good condition, whether they should have a full risk assessment. The screen uses fewer samples but more stringent evaluation criteria (standards) than regular risk assessments. Also called a **risk assessment screen**.

Lead-poisoned child: A child with an elevated blood level (see **EBL**).

Lead-specific detergent: A cleaning agent manufactured specifically for cleaning and removing leaded dust or other lead contamination.

Leaded dust: see **Lead-contaminated dust**.

Licensed: Holding a valid license or certification issued by EPA or by an EPA-authorized State or Tribal program pursuant to Title IV of the Toxic Substances Control Act. The license is based on certification for lead-based paint hazard evaluation or control work. See, also, **Certified**.

Maintenance: In the context of lead hazard control, work intended to maintain adequate living or occupancy conditions in target housing or a pre-1978 child-occupied facility; it may have the potential to disturb known or presumed lead-based paint.

Mat: See **Walkoff mat**.

Matrix blank: A sample of the matrix (paint chips, soil, or dust) that does not contain the analyte lead. This sample goes through the complete analysis, including digestion.

MDL: see **Method detection limit**.

Mean: The arithmetic average of a series of numerical data values; for example, the algebraic sum of the data values divided by the number of data values. Synonymous with **Arithmetic mean** and **Average**. See, also, the related term **Standard Deviation**.

Medical removal: The temporary removal of an employee from the job because the employee's blood lead level is at or above 50 µg/dL of the occurrence of an adult "elevated blood lead level" as defined in the OSHA Lead Exposure in Construction standard (29 CFR 1926.62(k)(1)(i)).

Method blank: see **Digestion blank**.

Method detection limit (MDL): The minimum concentration of an analyte that, for a given matrix and method, has a 99 percent probability of being identified, qualitatively or quantitatively measured, and reported to be greater than zero.

mg: Milligram; 1/1000 of a gram.

µg (or mcg): Microgram. The prefix micro means 1/1,000,000 (or one-millionth); a microgram is 1/1,000,000 of a gram and 1/1000 of a milligram; equal to about 35/1,000,000,000 (35 billionths) of an ounce (an ounce is equal to 28,400,000 mg).

Microgram: see **µg**.

Mil: 1/1000 of an inch; used to measure thickness.

Milligram: see **mg**.

Monitoring: An organized program of regular surveillance to determine that:

- (1) known or presumed lead-based paint is not deteriorating;
- (2) lead-based paint hazard controls, such as paint stabilization, interim control measures for soil, enclosure, or encapsulation have not failed;
- (3) structural problems do not threaten the integrity of hazard controls or of known or presumed lead-based paint, and
- (4) dust lead levels have not risen above applicable standards.

There are two types of monitoring activities: visual surveys by property owners and reevaluations by certified risk assessors. Visual surveys are generally conducted annually and at rental housing unit turn-over for the purpose of making the first three determinations listed above. Monitoring is not required in properties known to be free of lead-based paint. See also **Reevaluation**.

Note: Worker exposures must be monitored for lead; this is a different sense of “monitoring” than the facility and operational monitoring discussed above. See **Exposure Assessment**, Chapter 9 and Appendix 6.

Mouthable surface: see **Chewable surface**.

Multifamily housing: Housing that contains more than one dwelling unit per location. HUD, the U.S. Department of Agriculture, and other agencies’ programs may use a larger number of units, such as five or ten, to differentiate single family housing from multifamily housing in their regulations.

NLLAP requirements: Requirements specified by the EPA National Lead Laboratory Accreditation Program (NLLAP), for accreditation for the lead analysis of paint, soil, and dust matrixes by an EPA-recognized laboratory accreditation organization.

Offsite paint removal: The process of removing a component from a building and stripping the paint from the component at a paint stripping facility away from the building’s property.

Ongoing monitoring: see **Monitoring**.

Owner: A person, firm, corporation, guardian, conservator, receiver, trustee, executor, government agency or entity, or other judicial officer who, alone or with others, owns, holds, or controls the freehold or leasehold title or part of the title to property, with or without actually possessing it. This definition includes a vendee who possesses the title, but does not include a mortgagee or an owner of a reversionary interest under a ground rent lease.

Oxidation: An example of a chemical reaction that occurs upon exposure to oxygen and other oxidizing substances. Some coatings cure by oxidation; oxygen enters the liquid coating and cross links (attaches) the resin molecules. This film-forming method is also called “air cure” or “air dry.” Oxidation also causes rust to form on metals and paint to chalk.

Paint-lead hazard:

Lead-based paint on a friction surface that is subject to abrasion and where a dust-lead hazard is present on the nearest horizontal surface underneath the friction surface (e.g., the window sill, or floor);

Damaged or otherwise deteriorated lead-based paint on an impact surface that is caused by impact from a related building component;

A chewable lead-based painted surface on which there is evidence of teeth marks; or

Any other deteriorated lead-based paint in any residential building or child-occupied facility or on the exterior of any residential building or child-occupied facility.

Paint stabilization: The process of wet scraping, priming, and repainting surfaces coated with deteriorated lead-based paint. Paint stabilization also includes eliminating the cause(s) of paint deterioration, cleanup and clearance.

Paint removal: The removal of lead-based paint from surfaces; this may be an abatement strategy, or it may occur as a part of a renovation project.

Patch test: A test method or procedure to assess the adhesion of an encapsulant coating to a substrate covered with a layer or layers of lead-based paint.

Personal breathing zone samples: Air samples collected from the breathing zone of a worker (within a 1 foot radius of the worker's mouth) but outside the respirator. With respect to assessing lead exposures, the samples are collected with a personal sampling pump operating at 2 liters per minute, drawing air through a 37 mm mixed cellulose ester filter housed in a closed-face cassette with a pore size of 0.8 micrometers. See **Exposure assessment**.

Personal Protective Equipment (PPE): Equipment for protecting the eyes, face, head, and/or extremities; includes protective clothing, respiratory devices, and protective shields; used when hazards capable of causing bodily injury or impairment are encountered.

PHA: see **Public Housing Agency (PHA)**.

Pigment: Insoluble, finely ground materials that give paint its properties of color and hide.

Plastic: see **Polyethylene plastic**.

Play area: An area of frequent soil contact by children of under age 6 as indicated by, but not limited to, such factors including the following: the presence of outdoor play equipment (e.g., sandboxes, swing sets, and sliding boards), toys, or other children's possessions, observations of play patterns, or information provided by parents, residents, care givers, or property owners.

Polyethylene plastic: Polyethylene plastic or any other thick plastic material shown to demonstrate at least equivalent performance in containing dust and waste, resist tearing, and, after being properly sealed, remain leak tight with no visible signs of discharge during movement or relocation.

Polyurethane: An exceptionally hard and wear-resistant coating created by the reaction of polyols with a multifunctional isocyanate; often used to seal wood floors following lead-based paint hazard control work and cleaning.

Precision: The degree to which a set of observations or measurements of the same property, usually obtained under similar conditions, conform to themselves; a data quality indicator. Precision is usually expressed in either absolute or relative terms as standard deviation, variance, or range. Often known as "reproducibility." See also the related, but different, term **Accuracy**.

Primary prevention: The process of preventing lead hazards from occurring and, when they do occur, controlling lead hazards to prevent exposure *before* a child is poisoned. See, also, **Secondary prevention** and **Tertiary prevention**.

Primary standard: A substance or device with a property or value that is unquestionably accepted, within specified limits, in establishing the value of the same or related property of another substance or device.

Public Housing Agency (PHA): Any State, county, municipality, or other government entity or public body, or agency or instrumentality thereof, authorized to engage or assist in the development or operation of housing for low-income families.

Quality Assurance (QA): An integrated system of activities involving planning, quality control, quality assessment, reporting, and quality improvement to ensure that a product or service meets defined standards of quality within a stated level of confidence.

Quality Control (QC): The overall system of technical activities whose purpose is to measure and control the quality of a product or service so that it meets the needs of users. The aim is to provide a level of quality that is satisfactory, adequate, dependable, and economical.

Random sample: A sample drawn from a population in a way that allows each member of the population to have an equal chance of being selected. Random sampling is a process used to identify locations for the lead-based paint inspections in multifamily dwellings. See, also, **Targeted sample** and **Worst-case sample**.

RCRA: see **Resource Conservation and Recovery Act (RCRA)**.

Recognized laboratory: A laboratory that has been evaluated by the EPA's National Lead Laboratory Accreditation Program (NLLAP), and has demonstrated the capability to accurately analyze paint chip, dust, or soil samples for lead; the recognition for analysis of lead in a particular medium is held for a specified period of time, subject to continued quality control testing under the NLLAP.

Reevaluation: The combination of a visual assessment and collection of dust and, as appropriate, soil samples performed by a certified risk assessor to determine if the housing is free of lead-based paint hazards, and determine whether previously implemented lead-based paint hazard control measures are still effective.

Reference material: A material or substance that has at least one sufficiently well established property that can be used to calibrate an apparatus, assess a measurement method, or assign values to materials.

Removal: see **Paint removal**.

Renovation: According to EPA, the modification of any existing structure, or a portion of it, that results in the disturbance of painted surfaces, unless it is performed as part of an abatement or is a minor repair and maintenance activity, as these terms are defined by 40 CFR 745.223 and 745.83, respectively; see Appendix 6. The term renovation includes (but is not limited to): The removal, modification or repair of painted surfaces or painted components (e.g., modification of painted doors, surface restoration, window repair, surface preparation activity (such as sanding, scraping, or other such activities that may generate paint dust)); the removal of building components (e.g., walls, ceilings, plumbing, windows); weatherization projects (e.g., cutting holes in painted surfaces to install blown-in insulation or to gain access to attics, planing thresholds to install weather-stripping), and interim controls that disturb painted surfaces. A renovation performed for the purpose of converting a building, or part of a building, into target housing or a child-occupied facility is a renovation under this subpart.

Renovator: An individual who either performs or directs workers who perform renovations. Under EPA's Renovation, Repair, and Painting (RRP) Rule, a **Certified Renovator**.

Replacement: A strategy of abatement that involves the removal of building components coated with lead-based paint (such as windows, doors, and trim) and the installation of new components free of lead-based paint.

Reporting Limit: This value describes what a laboratory has determined as the lowest lead value it can report with sufficient confidence (such as 95% confidence) for the amount of the analyte (e.g., lead) in the matrix of interest (e.g., paint, dust, or soil).

Representative sample: A sample of a universe or whole (e.g., bare soil sample, waste sample pile, groundwater, or waste stream) that can be expected to exhibit the average properties of the entire universe or whole.

Resident: A person who regularly lives in a dwelling. A person who is not regularly living in the dwelling unit but is present when lead hazard control work is being done is an occupant of the dwelling who deserves the same level of protection as the residents of the dwelling.

Resource Conservation and Recovery Act (RCRA): The primary Federal statute governing waste management from generation to disposal. RCRA defines the criteria for hazardous and nonhazardous waste.

Risk assessment: An on-site investigation of a residential dwelling to determine the existence, nature, severity, and location of lead-based paint hazards. Risk assessments, which must be conducted by a certified risk assessor, include an investigation of the age, history, management, and maintenance of the dwelling, and the number of children under age 6 and women of childbearing age who are residents; a visual assessment; limited randomized environmental sampling (i.e., collection of dust wipe samples, soil samples, and deteriorated paint samples); and preparation of a report identifying abatement and interim control options based on specific conditions. HUD's Lead Safe Housing Rule requires risk assessments for certain types and amounts of HUD assistance; in these cases, a risk assessment must be no more than 12 months old to be considered current.

Risk assessment screen: See **Lead hazard screen**.

Risk assessor: A certified individual who has successfully completed lead-based paint hazard risk assessment training with an accredited training program and who has been certified to:

- (1) perform risk assessments;
- (2) identify acceptable abatement and interim control strategies for reducing identified lead-based paint hazards;
- (3) perform clearance testing and reevaluations; and
- (4) document the successful completion of lead-based paint hazard control activities.

RL: see **Reporting Limit (RL)**

Room Equivalent: A room equivalent is an identifiable part of a residence (e.g., room, house exterior, foyer, etc.).

Sample site: A specific spot on a surface being tested for lead loading or concentration.

Sampling Technician: A person who has completed a EPA-accredited or EPA-authorized State-accredited training course for sampling technicians and is qualified to perform clearance examinations after certain interim control activities. (Previously known as a clearance technician.)

Saponification: The chemical reaction between alkalis and oil that produces a type of soap. Because of saponification, oil and alkyd coatings will not adhere to masonry substrates, galvanized metals, or zinc-rich primers.

Screen: See **Lead hazard screen**.

Screening: The process of testing children to determine if they have elevated blood lead levels.

Secondary prevention: The process of identifying children who have elevated blood lead levels, and controlling or eliminating the sources of further exposure. See, also, **Primary prevention** and **Tertiary prevention**.

Secondary standard: A reference material with a well-defined, high quality, traceability linkage to existing **primary standards** for the same measurements. **SEL:** see **Substrate Equivalent Lead (SEL)**.

Site: Regarding hazardous waste, the land or body of water where a facility is located or an activity is conducted. The site includes adjacent land used in connection with the facility or activity. (See Chapter 10.)

Small quantity generator: Owners, contractors (generators), or both who produce less than 100 kg of hazardous waste per month and accumulate less than 100 kg of hazardous waste at any one time, or who produce less than 1 kg of *acutely* hazardous waste per month and accumulate less than 1 kg of *acutely* hazardous waste at any one time. (See Chapter 10.)

Soil-lead hazard: Bare soil on residential property that contains lead in excess of the standard established by the EPA under Title IV of the Toxic Substances Control Act. EPA standards for soil-lead hazards, published at 40 CFR 745.65(c), as of the publication of this edition of these *Guidelines*, is 400 µg/g in play areas and 1,200 µg/g in the rest of the yard. Also called **Lead-contaminated soil**.

Spectrum analyzer: A type of XRF analyzer that provides the operator with a plot of the energy and intensity, or counts, of K shell and/or L shell X-ray spectra, as well as a calculated lead concentration. See, also, **XRF analyzer**.

Spiked matrix: See **Spiked sample**.

Spiked sample: A sample prepared by adding a known mass of the target analyte (e.g., lead, as in leaded dust) to a specific amount of matrix sample (e.g., a dust wipe) for which an independent estimate of the target analyte mass is available. Spiked samples are used to determine, for example, the effect of the matrix on a method's recovery efficiency. See, also, the related term **Blind sample**.

Spot prime: To apply a paint primer to localized areas of exposed substrate.

Standard deviation: A measure of the precision of a reading; the spread of the deviation from the mean. The smaller the standard deviation, the more precise the analysis. The standard deviation is calculated by first obtaining the mean, or the arithmetic average, of all of the readings. A formula is then used to calculate how much the individual values vary from the mean – the standard deviation is the square root of the arithmetic average of the squares of the deviation from the mean. Many hand calculators and computer spreadsheets have an automatic standard deviation function. See, also, **Mean**.

Standard reference material (SRM): A certified reference material produced by the National Institute of Standards and Technology (NIST at the U.S. Department of Commerce) and characterized for absolute content independent of analytical method. See, also, **Certified reference material**.

Subsample: A constituent portion of a sample. A subsample may be either a field subsample or a laboratory subsample, depending on where the subsample is created. A subsample may be combined with other subsamples to produce a composite sample. See, also, **Composite sample**.

Substrate: A surface on which paint, varnish, or other coating has been applied or may be applied. Examples of substrates include wood, plaster, metal, and drywall.

Substrate effect: The radiation returned to an XRF analyzer by the paint, substrate, or underlying material, in addition to the radiation returned by any lead present. This radiation, when counted as lead X-rays by an XRF analyzer contributes to substrate equivalent lead (bias). The inspector may have to compensate for this effect when using XRF analyzers. See, also, **XRF analyzer**.

Substrate Equivalent Lead (SEL): The XRF measurement taken on an unpainted surface; used to calculate the corrected lead concentration on a surface by using the following formula: Apparent Lead Concentration - Substrate Equivalent Lead = Corrected Lead Concentration. See, also, **Apparent Lead Concentration (ALC)**, **Corrected Lead Concentration (CLC)**, and **XRF analyzer**.

Target housing: Any housing constructed before 1978 – except dwellings that do not contain bedrooms, or dwellings that are designated specifically for the elderly or persons with disabilities, unless a child younger than 6 resides or is expected to reside in the dwelling. In the case of jurisdictions that banned the sale or use of lead-based paint before 1978, the Secretary of HUD may designate an earlier date for defining target housing.

Targeted sample: A sample of dwelling units selected from an apartment building or housing development using information supplied by the owner, and not by random selection or on the basis of visual evidence obtained by the risk assessor. Based on the owner's information, the units are selected to have the greatest probability of containing lead-based paint hazards. See, also, **Worst-case sample** and **Random sample**.

TCLP: see **Toxicity Characteristic Leaching Procedure (TCLP)**.

Tribally-Designated Housing Entity: A designation by an Indian tribe's authority (i.e., tribal council or like body) of an entity other than the tribal government to receive grants and provide assistance under the Native American Housing Assistance and Self-Determination Act (P.L. 104-330 as amended) for affordable housing activities for Indians.

Tertiary prevention: Providing medical treatment to children with elevated blood lead levels to prevent more serious injury or death.

Testing combination: A unique surface to be tested that is characterized by the room equivalent, component, and substrate.

Test location: A specific area on a testing combination where XRF instruments will test for lead-based paint.

Toxicity Characteristic Leaching Procedure (TCLP): A laboratory test to determine if excessive levels of lead or other hazardous materials could leach from a sample into groundwater; usually used to determine if waste is hazardous based on its toxicity characteristics. (See Chapter 10.)

Trained: Successful completion of a training course in a particular discipline. For lead hazard evaluation or control work, the training course must be accredited by EPA or by an EPA-authorized State or tribal program, pursuant to Title IV of the Toxic Substances Control Act.

Treatment: A method designed to control lead-based paint hazards. Treatment includes interim controls, abatement, and removal.

Trisodium phosphate (TSP) detergent: A detergent that contains trisodium phosphate. These guidelines do not recommend using TSP.

Trough: see **Window trough**.

Truck-mounted vacuum unit: A vacuum system whose components, except for hoses and attachments, are located outside the building undergoing dust removal. The exhaust is vented outside so that the interior dust is not disturbed.

TSD: see **Treatment, Storage, and Disposal (TSD) facility**.

TSP: see **Trisodium phosphate (TSP) detergent**.

Useful life: The life expectancy of a coating before it requires refinishing or some other form of maintenance.

Vacuum/wet cleaning/vacuum cycle: The cleaning cycle that begins with HEPA vacuuming, followed by a wet cleaning with a detergent, followed by a final pass with a HEPA vacuum over the surface.

VOC: see **Volatile Organic Compound (VOC)**.

Volatile Organic Compound (VOC): Organic (carbon-based) substances that evaporate from a coating, such as during the coating or curing process.

Walkoff mat: A washable, fibrous material (preferably with a rubber or vinyl backing) positioned at an entryway to reduce transport of lead dust and/or lead soil into a building, or out of a work area.

White lead: A white pigment, usually lead carbonate. See, also, **Lead carbonate**.

Windowsill: see **Interior windowsill**.

Window stool: see **Interior windowsill**.

Window trough: For a typical double hung window, the portion of the exterior windowsill between the interior windowsill (or stool) and the frame of the storm window. If there is no storm window, the window trough is the area that receives both the upper and lower window sashes when they are both lowered. (Sometimes inaccurately called a window “well.”) See, also, **Window well**.

Window well: The space that provides exterior access and/or light to a window that is below grade, i.e., below the level of the surrounding earth or pavement. See, also, **Window trough**.

Worksite: Any interior or exterior area where lead-based paint hazard control work takes place. There may be more than one worksite in a dwelling unit or at a residential property.

Worksite preparation activities: A set of measures designed to protect residents and the environment from leaded dust, paint chips, or other forms of lead contamination through the erection of barriers and the establishment of access control, resident relocation or movement restrictions, warning signs, ventilation, engineering controls, and other measures.

Worst case sample: A sample of dwelling units having the greatest probability of containing lead-based paint hazards selected by a risk assessor on the basis of the risk assessor’s visual examination of all dwelling units in a housing development or apartment building. See, also, **Targeted sample** and **Random sample**.

XRF analyzer: An instrument that determines lead concentration in milligrams per square centimeter (mg/cm²) using the principle of X-ray fluorescence (XRF). Two types of XRF analyzers are used – direct readers and spectrum analyzers. In these *Guidelines*, the term XRF analyzer generally refers to portable instruments manufactured to analyze paint, and does not refer to laboratory grade units. Some portable instruments can be used to analyze lead in dust or soil.

Appendix 1:

Units of Measure Used in the Lead-Based Paint Field

Many of the units, terms, and concepts used in these *Guidelines* are new to the users. Most of the measures cited are in the Metric System of measure, rather than the English System that most people in the United States use on a daily basis. For this reason, a brief discussion of the most important concepts will be helpful to the user to develop a feeling for the quantities and terms used.

Terms and Definitions

An **atom** is one of the smallest units of matter, identifying a specific **element**. Lead is an element and is composed of atoms of lead; each lead atom behaves the same way when it interacts with other atoms. A **molecule** is a cluster of bound atoms which behave as a unit when interacting with atoms or other molecules. Materials made up of molecules are called compounds. The chemical and physical properties of compounds are unlike those of the elements which are present in them. Lead oxide, lead chromate, and lead acetate are all molecules formed when lead atoms combine with atoms of other elements to form molecules. These molecules are called **lead compounds** or sometimes lead salts. Lead acetate is a lead compound which has a sweet taste and is called "sugar of lead."

An **electron** is a negatively charged particle that orbits the positively charged nucleus of the atom. Every element requires a different number of electrons to neutralize the atom's positive nuclear charge. If an electron is removed from an atom then the atom becomes positively charged and is called an **ion**.

An **X-ray** is a type of high-energy electromagnetic radiation. Heat and light are other forms of electromagnetic radiation. Atoms of a particular element emit a characteristic set of X-rays when excited. No two elements emit identical sets of X-rays. The unit of energy we use in talking about X-rays is the kiloelectron volt (one thousand electron volts), abbreviated **keV**. Lead "K" X-rays have energies between 72 to 87 keV. A gamma ray is electromagnetic radiation which is emitted from the nucleus of a radioactive atom. Most gamma rays emitted by radioactive Cobalt 57 have an energy of 122 keV, more than enough energy to interact with lead atoms in paint and produce lead "K" X-rays. A 122 keV gamma ray will penetrate through many paint layers and into the substrate. Lead "K" X-rays can also penetrate many layers of paint and even through some walls or doors.

Mass Units

Large units of mass and their abbreviations:

Gram (g or gm): A unit of mass in the metric system. A nickel weighs about 1 gram, as does a 1 cube of water 1 centimeter on each side. A gram is equal to about 35/1000 (thirty-five thousandths of an ounce). Another way to think of this is that about 28.4 grams equal 1 ounce.

Kilogram (kg): The prefix "kilo-" means "1000 times". A kilogram is a unit of mass in the metric system that refers to 1000 grams or about 35 ounces. 35 ounces is about 2.2 pounds. About 454 g are equal to 1 pound.

Small units of mass and their abbreviations:

Milligram (mg): The prefix "milli-" means "1/1000 of" (one thousandth of). A milligram is 1/1000 of a gram or about 35/1,000,000 (thirty-five millionths) of an ounce. 28,400 mg are equal to 1 ounce.

Microgram (µg): The prefix "micro-" means "1/1,000,000 of" (one millionth of). A microgram is 1/1,000,000 of a gram or 1/1000 of a milligram. A microgram is equal to about 35/1,000,000,000 (thirty-five billionths) of an ounce. About 28,400,000 µg are equal to 1 ounce.

Length Units**Large units of length and their abbreviations:**

Meter (m): A meter is a metric unit of length equal to about 39.37 inches, which is about 3 and a third inches longer than a yard.

Decimeter (dm): The prefix "deci-" means "1/10 of". A decimeter is 1/10 of a meter. Another way to say this is that one meter will contain 10 decimeters. A decimeter is about 3.937 inches.

Centimeter (cm): The prefix "centi-" means "1/100 of". A centimeter is about 39/100 of one inch. 1 inch contains about 2.54 centimeters.

Small units of length:

Millimeter (mm): The prefix "milli-" means "1/1000 of". There are 1000 mm in 1 m. There are 10 mm in 1 cm. 25.4 mm equals 1 inch.

Micrometer (µm): The prefix "micro-" means "1/1,000,000 of". There are 1,000,000 µm in 1 m. There are 1000 µm in 1 mm and 10,000 µm in 1 cm. The term micron is also used interchangeably for µm. There are 25,400 microns in 1 inch.

Nanometer (nm): The prefix "nano-" means "1/1,000,000,000 of" (one billionth of). A meter can be divided into 1 billion nanometers. The wavelength of the light that is visible to us is in the range from about 350 to 700 nanometers; 450 nm is the wavelength of blue light; 550 nm, green light; 650 nm, red light. X-rays have much shorter wavelengths than visible light because they have more energy.

One other unit encountered in discussing paint films is not a Metric unit but an English unit. The unit that paint film thicknesses are usually (in the United States) measured in is the "mil." A **mil** is equal to 1/1000 of one inch. A 2-mil paint film per coat is considered average, assuming that the paint contains about 50% solids and has a spreading rate of 400 ft²/gallon. This would correspond to a paint film thickness of about 50 µm for a single coat of paint, because 1 mil is equal to about 25.4 microns. The thickness of plastic films is also, in the United States, usually measured in mils, such as "6-mil plastic sheeting."

Conversion to Areas and Volumes

An **area** is, for a square or rectangular surface or object, a measure of its length times its width. The area is expressed as a "square unit" (²). Square feet (ft²) and square inches (in²) are area units in the English System. Similarly, in the metric system we can have square meters (m²) or square centimeters (cm²).

$$1 \text{ ft}^2 = 929 \text{ cm}^2$$

$$1 \text{ square cm} = 1 \text{ cm}^2$$

1 square foot = 1 ft²

1 square inch = 1 in²

The **volume** is, for a cube or a box, a measure of its surface area times its height. The volume is expressed as a "cubic unit" (³), such as a cubic foot (ft³). A liter is a metric unit of volume equivalent to 1000 cm³ or 1000 cubic centimeters, abbreviated cc. A milliliter is 1/1000 of a liter and is abbreviated ml. The terms cm³, cc and ml are used interchangeably to refer to small liquid volumes. In the English System we use quarts, gallons, etc., as volume measures. A liter (L) is equal to 1.057 quarts. For measuring how much lead is in blood, the units of the weight of lead in volume of blood are often used; the volume used is a deciliter (dL), a tenth of a liter. This volume is somewhat less than half a cup.

Concentration Units

Weight per cent or % by weight (%w/w): The weight of lead in some mass unit per 100 weights of the total sample (in the same mass units). For example, if a 1 gram paint sample contains 0.1 g of lead, then the paint is 10.0% lead by weight (w/w). Also, 1 ounce of lead in 10 ounces of paint is 10% w/w lead. All weight percent measurements refer to the **dried** paint film.

Parts per million (ppm): The weight of lead per 1,000,000 weights of the total (including lead) sample. For example, if a paint sample contains 5,000 g of lead in 1 g of paint, then the lead concentration is 5,000 ppm or 0.5% w/w.

Area concentration: A mass of lead per unit area of the total paint sample, sometimes called "loading". This is independent of the volume (or thickness) of the paint sample. This unit is encountered in measuring paint by portable X-ray fluorescence instruments and laboratory techniques. The HUD regulatory level is 1.0 mg/cm² or 1000 µg/cm². Area concentration (loading) is also used to describe settled leaded dust levels in µg/ft² (micrograms of lead per square foot of surface area). 200 µg/ft² equals 1.85 mg/m² (milligrams of lead per square meter).

One **cannot** convert from ppm or % by weight to area concentration (mg/cm²) as measured by an X-ray fluorescence instrument in any predictable way unless the total mass per unit area of the sample is known. One reason is that the dilution factor of adding more non-leaded paint layers over an existing leaded one will not change the area concentration. However, adding additional layers of paint will change the % by weight. The area concentration is independent of the thickness of the paint layers. The XRF determines the lead mass per unit area as measured by X-ray emission from a lead layer (mg/cm²). The weight percent method measures the percent of lead in the bulk paint films by determining the weight of lead in the total paint sample.

Also, one **cannot** convert ppm in leaded dust to loading (µg/ft²) unless the total weight of the dust and the area of the surface from which the dust was collected are known. The total weight of dust cannot be determined by wipe sampling.

Some examples will serve to illustrate the concepts and quantities indicated in the previous discussion.

If we assume that a gallon of paint (12 lbs/gallon) having 50% solids and 12% lead is applied over 400 square feet, the area lead concentration would be:

$$(0.5)(0.12) \times \frac{(12 \text{ pounds/gallon})(1000 \text{ mg/g})}{(400 \text{ ft}^2/\text{gallon})(2.54 \text{ cm/in})^2 (12 \text{ in/ft})^2 (0.0022 \text{ pounds/g})} = 0.88 \text{ mg/cm}^2$$

This example illustrates that, in theory, 1 mg/cm² corresponds to a lot of lead in a single layer of paint (about 12% lead). Because of the presence of many layers of paint in target housing, on average 1 mg/cm² is about equal to 1% lead.

To conceptualize quantities of lead in paint we can make some reasonable assumptions. If one assumes a lead pigment particle size of about 1 mm in diameter, and that the particles are about the size of grains of salt (but heavier) and that one of these pigment grains weighs about 30 µg, only about 30 of these grains distributed in an area of 1 cm² will be required to give an area concentration near 1 mg/cm². The lead pigment particles will actually occupy only a small fraction of the total 1 cm² area. This small amount will usually be visible to the eye, under conditions of good light and contrast, on an abated surface, if present as a post-abatement residue.

Can painting over leaded dust create a lead-based paint? While one could conceivably apply the definition of lead-based paint (5,000 ppm) and assume a certain thickness in the new paint film to calculate the weight concentration of lead in the new paint film from the dust loading in µg/ft², the result is well above the dust clearance standards. Consider the following example: If, after treatment, 34,000 µg/ft² of leaded dust remains on the surface, and it is painted over with a lead-free new paint at a rate of 400 ft²/gallon with a density of 12 lbs/gallon and 50% solids by weight, the total weight of the paint solids per unit area is 7.32 mg/cm². Thus, the weight percent concentration of lead in the new paint film would be about 5,000 ppm:

$$\frac{(12 \text{ pounds/gallon})(0.50 \text{ g/g})(0.488 \text{ g/cm}^2 / \text{pounds/ft}^2)(1000 \text{ mg/g})}{400 \text{ ft}^2/\text{gallon}} = 7.32 \text{ mg/cm}^2$$

$$(34,000 \text{ µg/ft}^2)(0.001 \text{ mg/µg})(1 \text{ ft}/12 \text{ inches})^2 (1 \text{ inch}/2.54 \text{ cm})^2 = 0.0366 \text{ mg/cm}^2$$

$$\text{ppm by weight} = \frac{(0.0366 \text{ mg/cm}^2)(1,000,000)}{7.32 \text{ mg/cm}^2} = 5,000 \text{ ppm}$$

Since the EPA standard for lead-based paint is 5,000 ppm (0.5%), this means that the new lead-free paint would mix with the leaded dust and become lead-based paint. However, it should be noted that it is extremely unlikely that 34,000 µg/ft² would be found on stripped surfaces if the surfaces have been stripped and cleaned adequately.

If one relied on XRF testing to determine lead contamination of surfaces where the lead paint had been removed, it would almost certainly be necessary to correct for substrate effects, since the readings would probably be quite low. If some of the lead did soak into the substrate during the removal process, determination of the true substrate effect would be quite difficult, if not impossible. Current XRF instruments have detection levels well above 0.0366 mg/cm².

The diameter of a lead particle found in paint will be on the order of 0.1 to 10 micrometers (µm). Scraping, sanding, and heating lead-based paint will result in the formation of small particles. These particles are usually much smaller than the salt grain examples used above. These very small particles actually float in the air and can be inhaled as we breathe. Very small particles do not settle very rapidly. For this reason very stringent worker protection and clean-up measures are needed for lead hazard control work in lead-based paint abatement.

Heat gun removal at temperatures below 1,100° F will not melt and vaporize lead into the air. It could, however, produce paint "soot" particles from the paint film which will trap the tiny lead particles and allow them to become airborne. Welding and open flame burning temperatures melt and vaporize lead compounds in paint; these temperatures are much higher than those generated by heat guns.

Biological Quantities of Lead

Blood lead levels are typically expressed in micrograms of lead (μg) per deciliter of blood (dL), that is, $\mu\text{g}/\text{dL}$. Microgram is a millionth of a gram, and a deciliter is one tenth of a liter. A child can eliminate approximately 5 micrograms of lead for each kilogram of body weight in one day. If a 10-kilogram (22 lb) child ingested a paint chip containing 1.0 mg of lead, then, assuming that the digestive system were able to digest the entire paint chip, the child would ingest approximately 20 times more lead than could be eliminated by his or her body in one day. If we say that only 10% of the lead in the paint chip is absorbed into the child's body then the child would still ingest twice as much lead, from one paint chip, as could be eliminated in 24 hours.

Dr. Julian Chisholm, in "Lead Based Paint in Housing," National Institute of Building Sciences LBP Task Force Report, February 20, 1988, pp. 23-24, wrote that:

Experimental and human data indicate that chronic average daily ingestion of lead of 16.8 μg Pb/kg of body weight or 168 μg Pb/day in a 10 kg child from paint could raise blood lead concentrations from 20 to 54 $\mu\text{g}/\text{dL}$.

In May 2012, the Centers for Disease Control and Prevention (CDC) its definition of elevated blood lead level to use a "reference value" of the blood lead level at the 97.5th percentile of children aged 1 to 5 years old as determined based on its National Health and Nutrition Examination Survey (NHANES). As of the publication of this edition of these *Guidelines*, the reference level was 5 $\mu\text{g}/\text{dL}$.

Appendix 2: CDC's Childhood Lead Poisoning Prevention Program

For a current list of CDC-assisted State and local childhood lead poisoning prevention programs, see the CDC website at <http://www.cdc.gov/HealthyHomes/programs.html>. [Accessed 7/27/2012; this site may be moved or deleted later.]

Appendix 3:

U.S. EPA Regional Offices

Each EPA Regional Office is responsible within its states for the execution of the Agency's programs. Go to <http://www.epa.gov/epahome/regions.htm> find your state or region. [Accessed 7/27/2012; this site may be moved or deleted later.]

Appendix 4: OSHA Regional Offices and State Programs

To identify OSHA regional offices, see the OSHA website at www.osha.gov/html/RAmap.html. For a current list of State programs, see the OSHA website at <http://www.osha.gov/dcsp/osp/index.html>. [Accessed 7/27/2012; this site may be moved or deleted later.]

Appendix 5: EPA Training, Certification and Accreditation Programs

For a current list of EPA training and certification programs, see the EPA website at www.epa.gov/oppt/lead/pubs/traincert.htm. [Accessed 7/27/2012; this site may be moved or deleted later.]

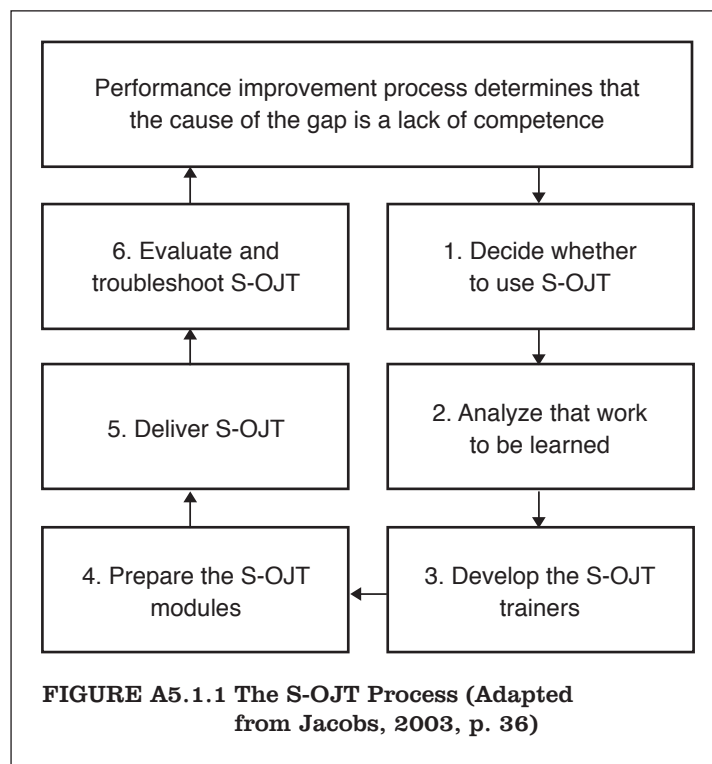
Appendix 5.1:

Structured On-the-Job Training (OJT) vs. Unstructured OJT:

The EPA's Renovation, Repair and Painting (RRP) Rule allows for the certified renovator overseeing a renovation project to conduct on-the-job training (OJT) of workers instead of their becoming certified renovators. OJT is a traditional method of teaching workers how to perform tasks. (Gray, 1998; Campbell, 1990). In recent years, the training and education profession has made significant improvements in instructional design theories and few studies have led to industry acceptance of results that identify two distinct types of OJT, referred to as "structured OJT" (SOJT) and "unstructured OJT" (Levine, 1997). These types of training have different characteristics and levels of effectiveness. See figure A5.1.1, a conceptual flowchart of the SOJT process.

SOJT involves planning in which jobs are analyzed and broken down into their component tasks, and instructors are provided lesson plans and materials. (See Figure A5.1.1.) SOJT requires work up-front, but produces consistent training outcomes of predictable quality. Lacking structure, unstructured OJT produces inconsistent training outcomes, for example (Jacobs, 2003):

- ◆ The desired training outcome is rarely achieved, and when it is, trainees rarely achieve the same outcomes.
- ◆ The training content is often inaccurate or incomplete, and may represent an accumulation of bad habits, misinformation, and possibly unsafe shortcuts on which employees have come to rely over time.
- ◆ Experienced employees are seldom able to communicate what they know in a way that others can understand.
- ◆ Experienced employees use different methods each time they conduct the training, and not all of the methods are equally effective.
- ◆ Many employees fear that sharing their knowledge and skills will reduce their own status as experts and perhaps even threaten their job security, or they may not be given adequate time away from their duties to deliver the training to others.



- ◆ Unstructured OJT leads to increased error rates, lower productivity, and decreased training efficiency, compared to structured OJT, and is less effective at reaching the training objectives.

No regulatory criteria exist for successfully completing OJT in the conduct of renovation or other lead-based paint activities. Regarding the two broad categories of OJT, structured OJT (SOJT) and unstructured OJT, the RRP Rule allows either type. As described below, HUD recommends that OJT be structured.

Improper handling of lead-based painted components during renovation, remodeling or painting has been shown to create dust lead hazards (EPA, 1997). This possibility must be considered in the selection of a training solution. In order to achieve consistent, positive, training outcomes, HUD recommends that structured OJT be used when workers are not trained to become certified, and that all training be performed by qualified and experienced instructors to facilitate quality and consistency of instruction.

Small companies may not be able to offer OJT themselves. Such firms may not be able to develop or implement an OJT program on their own and may choose production over training. HUD recommends partnerships among lead professionals to provide OJT training to small firms and in other OJT settings.

A cost-benefit analysis is helpful when selecting a training method. Although many people believe that classroom training of large groups is very cost-effective because the training costs are spread over the group, this is not always true. If a training decision is made on cost alone, SOJT has been shown to be the preferred training method over unstructured OJT and in some cases, over classroom training (Jacobs, Jones and Neil, 1992; Jacobs, 1994). This is because the structure of the training allowed mastery of skills in one-fifth the time of UOJT; that is, training objectives were achieved five times faster than using UOJT. If they are unpaid during training, employees will lose fewer wages during the training period if SOJT is used.

References

- Campbell, 1990. Campbell, C. An Overview of On-the-Job Training, In Pfau, R.H. (Ed.), *On-the-job Training*. Gaborone, BWA: Macmillan Botswana. 1990.
- EPA, 1997. U.S. Environmental Protection Agency. Draft Final Report on Characterization of Dust Lead Levels After Renovation, Repair and Painting Activities, Prepared by Battelle under EPA Contract No. EP-W-04-021. 1997. <http://www.epa.gov/lead/pubs/duststudy01-23-07.pdf>
- Gray 1998. Gray, K. C., & Herr, E. *Workforce education: The basics*. Allyn and Bacon. Needham Heights, MA. 1998.
- Jacobs, Jones and Neil, 1992. Jacobs, R. L., Jones, M. J., and Neil, S. A Case Study in Forecasting the Financial Benefits of Unstructured On-the-Job Training. *Human Resource Development Quarterly*, 3(2):133–139, Summer 1992.
- Jacobs, 1994. Jacobs, R.L. Case Studies that Compare the Training Efficiency and Product Quality of Unstructured and Structured OJT. In J. Phillips (ed.), *The return on investment in human resource development: cases on the economic benefits of HRD*. Alexandria, VA: American Society for Training and Development, 123-132. 1994.
- Jacobs, 2003. Jacobs, R.L. *Structured On-the-Job Training: Unleashing Employee Expertise in the Workplace*, 2nd ed., Berrett-Koehler Publishers, Inc., San Francisco. 2003. ISBN: 157-675242-9.
- Levine, 1997. Levine, C.I. *On-the-Job Training*. American Society for Training and Development Press. Alexandria, VA. 1997. ISBN 978-156286-215-2. <http://store.astd.org/Default.aspx?tabid=167&ProductId=17106>

Appendix 6:

HUD, EPA, OSHA, CPSC, and NPS Lead Paint Rules¹

EPA-HUD Lead Disclosure Rule

The **Lead Disclosure Rule** (the identical [24 CFR 35, subpart A](#) and [40 CFR 745, subpart F](#)) was jointly issued by HUD and the Environmental Protection Agency (EPA) in 1996 ([61 FR 9063-9088, March 6, 1996](#)) as part of implementing Section 1018 of the Residential Lead-Based Paint Poisoning Lead Hazard Reduction Act of 1992 (commonly referred to as Title X). As of 2011, HUD and EPA had issued three Interpretive Guidance documents about the Lead Disclosure Rule; these are available from both agencies' websites on the Rule. The links from HUD's Lead Disclosure rule web page, http://portal.hud.gov/hudportal/HUD?src=/program_offices/healthy_homes/enforcement/disclosure, are at:

- ◆ [Part I, August 21, 1996](#)
- ◆ [Part II, December 5, 1996](#)
- ◆ [Part III, August 2, 2000](#)

Links to the Interpretive Guidance documents are also available at EPA's Residential Lead-Based Paint Disclosure Program web page, <http://www.epa.gov/lead/pubs/leadbase.htm>.

This section of the statute addresses lead hazard disclosure requirements for almost all target housing built before 1978 that is offered for sale or lease. Since Title X focuses on children and pregnant women, target housing is defined as "any housing constructed prior to 1978, except housing for the elderly or persons with disabilities (unless any child who is less than 6 years of age resides or is expected to reside in such housing) or any 0-bedroom dwelling." The rule identifies four exceptions for which it does not apply to certain real estate transactions of certain target housing:

- 1) sales of target housing at foreclosure;
- 2) leases of target housing that a certified lead-based paint inspector found to be lead-based paint free, with suitable documentation;
- 3) short-term leases of 100 days or less, where no lease renewal or extension can occur; and
- 4) renewals of existing leases in target housing in which the landlord has previously disclosed all required information and where no new information has come into the possession of the landlord.

¹ Appendix 6 of the 1995 Guidelines, which was a list of other organizations providing the EPA lead-based paint abatement supervisor and inspector course curriculum, has been deleted. Training providers for these courses are now accredited by EPA-authorized State lead programs or by EPA-operated lead programs. See the website at www.epa.gov/lead/pubs/traincert.htm for a list of EPA-authorized State lead program offices and EPA regional offices. From these offices you can obtain lists of approved training providers in a particular State. [Accessed 7/27/2012; this site may be moved or deleted later.]

The offeror (owners or their agents) and any real estate agents involved in the transaction have responsibilities under Title X. (Buyer's agents paid entirely by the purchaser are not considered "agents" under this rule.) A summary of Title X is provided at the end of this Appendix.

At a minimum, Title X requires the offeror to provide the potential buyer or tenant the following information before signing a written agreement or making an oral agreement:

- 1) an EPA (or EPA-approved State) brochure on lead hazards for residential properties built before 1978;
- 2) information regarding the presence of lead-based paint and/or lead-based paint hazards, as well as any other available information, including records and reports on the subject; and,
- 3) a certification that all the parties sign and date. The certification must indicate that seller or landlord provided:
 - a) the required Lead Warning Statement;
 - b) disclosure of the information in item 2, above; and
 - c) a list of available records or reports (or a statement that no such documents are available).

The brochure, or pamphlet, in item 1 is available in (as of 2011) six languages; the links to these versions are on the EPA website at <http://www.epa.gov/lead/pubs/leadprot.htm>, and on the HUD website at http://portal.hud.gov/hudportal/HUD?src=/program_offices/healthy_homes/enforcement/disclosure. HUD recommends that the brochure be provided in the language of the sales or least contract, if that language is one of those for which the brochure is available. (If the language of the contract is not one of those listed, check the EPA or HUD websites to see if it has been translated into that language.) The titles, and the links to the individual adaptations on the EPA web page, are:

- ◆ [Protect Your Family From Lead in Your Home \(English\)](#)
- ◆ [Proteja a Su Familia Contra el Plomo en el Hogar \(Spanish\)](#)
- ◆ [Hay Bao Ve Gia Dinh Cua Ban Khoi Bi Nhiem Chi O Trong Nha \(Vietnamese\)](#)
- ◆ [В Вашем доме: защитите свою семью от свинца \(Russian\)](#)
- ◆ [\(Arabic\) كتيبي في دوجومرلا صاصرلا نم كترسأ مرحا](#)
- ◆ [Ka Badbaa di Qoyska Halista Leedhka \(Somali\)](#)

The certification in item 3 must also indicate that the buyer or tenant received the identified materials. In the case of a sales transaction, the certification must also indicate that the offeror provided the buyer the opportunity to conduct a lead-based paint risk assessment or inspection and whether or not that opportunity was taken. Finally the certificate must include a statement by any real estate agent involved with the seller or landlord that the agent: informed the clients of their obligations under 24 CFR 35, Subpart A, or the identical 40 CFR 745, subpart F, and the agent is aware of his/her duty to ensure compliance.

The agent and the client must retain the certification and acknowledgment for at least three years. Agents who fulfill the required duties are not liable where the client fails to comply with these requirements or for the failure of the buyer's or tenant's agent to transmit materials provided in good faith. The agents should educate potential buyers and sellers about lead hazards and should encourage lead risk assessments or lead-based paint inspections of pre-1978 dwellings.

The Lead Disclosure Rule provides additional information on scope, definitions, recordkeeping requirements, and enforcement.

In the case of a **sale**, the Lead Disclosure Rule requires each contract to sell target housing shall include an attachment containing the following elements, in the language of the contract (e.g., English, Spanish):

- 1) a Lead Warning Statement that contains specific wording;
- 2) a statement by the seller disclosing the presence of known lead-based paint and/or lead-based paint hazards in the target housing being sold or indicating no knowledge of the presence of lead-based paint and/or lead-based paint hazards, including any additional known supporting information;
- 3) a list of any records or reports available to the seller pertaining to lead-based paint and/or lead-based paint hazards in the housing that have been provided to the purchaser, or the absence of any information;
- 4) a statement by the purchaser affirming receipt of the information in the previous two items;
- 5) a statement by the purchaser whether or not they availed themselves of the opportunity to conduct the risk assessment or inspection;
- 6) that any real estate agent involved in the transaction has informed the seller of the seller's obligations and agent is aware of his/her duty to ensure compliance with the requirements of the Lead Disclosure Rule; and
- 7) the signatures of the sellers, agents, and purchasers, certifying to the accuracy of their statements, to the best of their knowledge, along with the dates of signature.

In the case of a **lease**, the Lead Disclosure Rule requires that each contract to lease target housing shall include, as an attachment or within the contract, the following elements, in the language of the contract (e.g., English, Spanish):

- 1) a Lead Warning Statement that contains specific wording stated in the Rule;
- 2) a statement by the landlord disclosing the presence of known lead-based paint and/or lead-based paint hazards in the target housing being sold or indicating no knowledge of the presence of lead-based paint and/or lead-based paint hazards, including any additional known supporting information;
- 3) a list of any records or reports available to the landlord pertaining to lead-based paint and/or lead-based paint hazards in the housing that have been provided to the tenant, or the absence of any information;
- 4) a statement by the tenant affirming receipt of the information in the previous two items;
- 5) that any agent involved in the transaction has informed the tenant of the landlord's obligations and agent is aware of his/her duty to ensure compliance with the requirements of the Lead Disclosure Rule; and
- 6) the signatures of the landlords, agents, and tenants, certifying to the accuracy of their statements, to the best of their knowledge, along with the dates of signature.

The [preamble to the Lead Disclosure Rule](#) contains a sample (that is, non-mandatory) one-page disclosure form for sales and one for leases (61 FR 9066, at 9074 and 9075, March 6, 1996); both forms can be downloaded in English or Spanish from the HUD website (http://portal.hud.gov/hudportal/HUD?src=/program_offices/healthy_homes/enforcement/disclosure) or EPA website (<http://www.epa.gov/lead/pubs/leadbase.htm>). The titles, and the links to the individual adaptations on the EPA web page, are:

- ◆ [Sample Form: Lessor's Disclosure of Information on Lead-Based Paint and/or Lead-Based Paint Hazards](#)
- ◆ [Sample Form: Declaracion de Informacion por Arrendadores sobre Pintura a Base de Plomo y/o Peligros de la Pintura a Base de Plomo](#)
- ◆ [Sample Form: Seller's Disclosure of Information on Lead-Based Paint and/or Lead-Based Paint Hazards](#)
- ◆ [Sample Form: Declaracion de Informacion por los Vendedores sobre Pintura a Base de Plomo y/o Peligros de la Pintura a Base de Plomo](#)

The Lead Disclosure Rule requires that the seller, and any agent, shall retain a copy of the required completed documents for at least three years after the agreements are effective. With respect to enforcement, any person who knowingly fails to comply with any provision of this subpart shall be subject to civil monetary penalties or who knowingly violates the provisions of the Lead Disclosure Rule shall be jointly and severally liable to the purchaser or tenant in an amount equal to 3 times the amount of damages incurred by such individual. Failure or refusal to comply with the Lead Disclosure Rule may result in civil and/or criminal sanctions.²

When evaluating hazards as part of a risk assessment, the risk assessor must use either the standards issued by the EPA, as described in Chapter 5, Risk Assessment and Reevaluation, or a state or local standard if it is more protective (e.g., lower). Similarly, when evaluating paint as part of a lead-based paint inspection, the lead-based paint inspector must use either the standards issued by the EPA, as described in Chapter 7, Lead-Based Paint Inspection, or a state or local standard if it is more protective (e.g., lower).

For more information about the Lead Disclosure Rule, other lead safety rules, or general information about lead hazards and lead poisoning prevention, contact the National Lead Information Center at 800-424-LEAD or <http://www.epa.gov/lead/pubs/nlic.htm>. If you are a hearing- or speech-impaired person, you may reach the above telephone number through TTY by calling the toll-free Federal Relay Service at 800-877-8339.

The **Lead Safe Housing Rule** (LSHR) (24 CFR Part 35, subparts B-R) was issued by HUD in 1999 as part of implementing Sections 1012 and 1013 of Title X. Title X holds the federal government to a higher standard of care than it does residential property owners in general by requiring most Federally assisted housing to have some specified type of evaluation for the presence of lead-based paint and/or lead-based paint hazards, and controls based on the findings of the evaluation. HUD published the LSHR in the Federal Register (64 FR 50140-50231, September 15, 1999), and later published technical amendments (69 FR 34262-34276, June 21, 2004). The *LSHR as amended June 21, 2004*, and *highlighted changes to Lead Safe Housing Rule reflecting the technical amendments*, are posted on HUD's *LSHR website*, http://portal.hud.gov/hudportal/HUD?src=/program_offices/healthy_homes/enforcement/lshr. HUD has issued interpretive guidance on the LSHR, and updated it to reflect the 2004 technical amendments; the updated guidance is posted at *Information and Guidance for HUD's Lead Safe Housing Rule* on HUD's *LSHR website*. HUD has also developed a Lead-Based Paint Compliance Advisor, posted at <http://portal.hud.gov/CorvidRpt/HUDDLBP/welcome.html>. This Advisor presents the requirements of the LSHR, and, by analyzing user responses to a short number of questions, generates a report of project-specific requirements that can be downloaded or printed. Remaining questions about the LSHR may be sent to the HUD Lead Regulations hotline at Lead.Regulations@HUD.gov or (202) 402-7698.

² As of November 2011, the civil money penalties for Lead Disclosure Rule violations were up to \$16,000 per violation; each of the 10 elements of a lease transaction, or the 11 elements of a sales transaction may, if violated, result in a penalty being levied up to that dollar amount. In the case of multi-family target housing and/or multiple properties with a single owner or owner's agent, the elements pertain to each real estate transaction on each dwelling unit separately, so the total maximum penalty is multiplied by the number of units and the number of turnovers for which a repeated violation occurred. For example, if a residential property with 9 housing units had each unit rented on two occasions, there were 18 rental transactions. If the property were covered by the rule but there was no compliance with it, there were 18 times 10, or 180 elements of the rule that were violated, and (as of November 2011), the penalty could be as much as 180 times \$16,000, or \$2.88 million.

The LSHR has a specific subpart (a portion of Part 35) on requirements and definitions, several subparts for different types of housing assistance and activities, and a subpart on methods and standards for the evaluation and reduction of lead-based paint.

The LSHR is implemented in conjunction with other applicable Federal, State and local regulations. For example:

- ◆ Lead abatement activities in target housing are conducted using certified lead abatement firms and personnel in accordance with the EPA's lead training and certification rule, 40 CFR 745, subpart L, or with a State or Indian Tribal certification program authorized by the EPA under 40 CFR 745, subpart Q.
- ◆ Renovation, repair, remodeling, weatherization, and painting work in target housing that disturbs more than EPA-specified minimal amounts must be conducted in accordance with the EPA's Renovation, Repair and Painting (RRP) Rule; see the discussion of the RRP Rule below
- ◆ While the LSHR does not require that firms conducting interim controls be certified, the RRP rule does so (for work more extensive than the RRP rule's threshold for minor repair and maintenance activities). On the other hand, the RRP rule provides that its cleaning verification procedure need not be conducted when work is cleared by a clearance examination under the LSHR or contract requirement, although EPA encourages property owners who include clearance in their renovation contracts also to require renovation firms to perform cleaning verification.
- ◆ Lead evaluation and control regulations of States, tribes, or localities that are at least as protective as the LSHR are to be followed (24 CFR 35.150(a)). For instance, some localities use a definition of LBP of 0.7 mg/cm², and some States or localities require abatement of paint below a certain height in housing where a young child resides.
- ◆ The U.S. Department of Labor's Occupational Safety and Health Administration (OSHA) requirements, particularly, its Lead in Construction Rule (29 CFR 1926.1101) and its Lead in General Industry Standard (29 CFR 1910.1025), apply on all projects where employees have the potential for exposure to lead. See the discussion of these standards below.

A summary of the levels of protection under the LSHR, and the basic requirements by subpart follows.

Lead Safe Housing Rule Levels Of Protection

Level of protection	Subpart, section, and type of assistance	Hazard reduction requirements
1	Subpart G, § 35.630, Multi-family mortgage insurance for conversions and major rehabilitations. Subpart L, § 35.1120(a), Public housing being modernized. ^{a *} Subpart L, § 35.1125, Public housing acquisition and development. ^{a *}	Abatement of all lead-based paint, and, for the public housing activities shown with *, all lead-based paint hazards. ^b
2	Subpart J, § 35.930(d), Properties receiving more than \$25,000 per unit per year in rehabilitation assistance. ^c	Abatement of lead-based paint hazards.
3	Subpart G, § 35.620, Multi-family mortgage insurance for properties constructed before 1960, other than for conversions and major rehabilitations. Subpart H, § 35.715, Project-based assistance for multi-family properties receiving more than \$5,000 per unit per year. ^a Subpart I, HUD-owned multi-family property. ^{a c} Subpart J, § 35.930(c), Properties receiving more than \$5,000 and up to \$25,000 per unit per year in rehabilitation assistance. ^c Subpart L, § 35.1120(b), Public housing not yet modernized. ^a	Interim controls of lead-based paint hazards, and ongoing lead-based paint maintenance.
4	Subpart F, HUD-owned single family properties. ^d Subpart H, § 35.720, Project-based assistance for multi-family properties receiving up to \$5,000 per unit per year and single family properties. ^a Subpart K, Acquisition, leasing, support services, or operation. Subpart M, Tenant-based rental assistance.	Paint stabilization, and ongoing lead-based paint maintenance.
5	Subpart G, § 35.625, Multi-family mortgage insurance for properties constructed after 1959.	Ongoing lead-based paint maintenance.
6	Subpart J, § 35.930(b), Properties receiving up to and including \$5,000 in rehabilitation assistance. ^c	Safe work practices during rehabilitation of painted surfaces.

^a Response of risk assessment, interim controls or abatement of any lead-based paint hazards identified, and notification of building residents required for Environmental Intervention Blood Lead Level (EIBLL) case (§ 35.1130).

^b Ongoing LBP maintenance required if the abatement uses encapsulation or enclosure.

^c Ongoing LBP maintenance required for rehabilitation assistance only if HOME funds used for rental unit; ongoing LBP maintenance and reevaluation required for HUD-owned or mortgagee-in-possession multi-family housing only if HUD owns it for over 12 months.

^d Ongoing LBP maintenance not required for a HUD-owned single family housing after disposition, although HUD recommends it unless the housing has been found to be lead-based paint free.

SUMMARY OF LEAD SAFE HOUSING RULE REQUIREMENTS			
Subpart of Rule/ Type Program	Year Built	Owner/Landlord Requirements ^{1, 2, 3}	Participant Monitoring Requirements
A Lead Disclosure Rule	Pre-1978	<ul style="list-style-type: none"> ◆ Provide EPA (or State) lead hazard information pamphlet ◆ Disclose knowledge about LBP and its hazards to potential buyers or tenants and seller's agents. ◆ Complete lead disclosure form ◆ Provide opportunity for buyer to conduct evaluation. 	Have system in place that documents they ensure Owner/Landlord complies with Lead Disclosure Rule
B General Requirements and Definitions	Pre-1978	<ul style="list-style-type: none"> ◆ Definitions. ◆ Exemptions.⁴ ◆ Notice of acceptable evaluation and hazard reduction activities. ◆ Pamphlet. 	
C Disposition by Federal Agency Other Than HUD	Pre-1960	<ul style="list-style-type: none"> ◆ LBP inspection and risk assessment. ◆ Abatement of LBP hazards. ◆ Passing clearance exam. ◆ Notice to occupants of LBP inspection, risk assessment, and clearance results. 	Agency, or its agent, must document compliance with the Lead Safe Housing Rule unless waived due to insufficient resources.
	1960-1977	<ul style="list-style-type: none"> ◆ LBP inspection and risk assessment. ◆ Notice to occupants of results. 	
D Project-Based Assistance by Federal Agency Other Than HUD	Pre-1978	<ul style="list-style-type: none"> ◆ Provision of pamphlet. ◆ Risk assessment. ◆ Interim controls. ◆ Passing clearance exam. ◆ Notice to occupants. ◆ Response to EIBLL child.⁵ 	Have system in place that documents they ensure Owner/Landlord complies with Lead Safe Housing Rule and Lead Disclosure Rule
F HUD-Owned Single Family Sold With a HUD-Insured Mortgage	Pre-1978	<ul style="list-style-type: none"> ◆ Visual assessment. ◆ Paint stabilization. ◆ Passing clearance exam. ◆ Notice to occupants of clearance. 	

SUMMARY OF LEAD SAFE HOUSING RULE REQUIREMENTS			
Subpart of Rule/ Type Program	Year Built	Owner/Landlord Requirements ^{1, 2, 3}	Participant Monitoring Requirements
G Multi-family Mortgage Insurance:			
1. For properties that are currently residential	Pre-1960	<ul style="list-style-type: none"> ◆ Provision of pamphlet. ◆ Risk assessment. ◆ Interim controls. ◆ Passing clearance exam. ◆ Notice to occupants. ◆ Ongoing LBP maintenance. 	Have system in place that documents they ensure Owner/Landlord complies with Lead Safe Housing Rule and Lead Disclosure Rule
	1960-1977	<ul style="list-style-type: none"> ◆ Provision of pamphlet. ◆ Ongoing LBP maintenance. 	
2. For conversions and major renovations.	Pre-1978	<ul style="list-style-type: none"> ◆ Provision of pamphlet. ◆ LBP inspection. ◆ Abatement of LBP. ◆ Passing clearance exam. ◆ Notice to occupants ◆ Ongoing LBP maintenance if abate using encapsulation or enclosure. 	
H HUD Project-Based Assistance:			
For all Multi-family properties	Pre-1978	<ul style="list-style-type: none"> ◆ Provision of pamphlet. ◆ Notice to occupants. ◆ Ongoing LBP maintenance. ◆ Response to EIBLL child.⁵ 	If no bilateral agreement with owner/Landlord, have system in place that documents they or subrecipients ensure Owner/Landlord complies with Lead Safe Housing Rule and Lead Disclosure Rule
1. Property receiving more than \$5,000 per unit per year	Pre-1978	<ul style="list-style-type: none"> ◆ Risk assessment. ◆ Interim controls. ◆ Passing clearance exam. ◆ Reevaluation every two years 	
2. Property receiving less than or equal to \$5,000 per unit per year, and single family properties	Pre-1978	<ul style="list-style-type: none"> ◆ Visual assessment. ◆ Paint stabilization. ◆ Passing clearance exam. ◆ Reevaluation every two years 	

SUMMARY OF LEAD SAFE HOUSING RULE REQUIREMENTS				
Subpart of Rule/ Type Program	Year Built	Owner/Landlord Requirements ^{1, 2, 3}	Participant Monitoring Requirements	
I	HUD-Owned Multi-family Property	Pre-1978	<ul style="list-style-type: none"> ◆ Provision of pamphlet. ◆ LBP inspection and risk assessment. ◆ Interim controls. ◆ Passing clearance exam. ◆ Notice to occupants. ◆ Ongoing LBP maintenance and reevaluation if HUD owns property for over 12 months. ◆ Response to EIBLL child.⁵ 	
J	Rehabilitation Assistance:			
	For all Properties	Pre-1978	<ul style="list-style-type: none"> ◆ Provision of pamphlet. ◆ Paint testing of surfaces to be disturbed, or presume LBP. ◆ Notice to occupants. ◆ Ongoing LBP maintenance if HOME. 	Have system in place that documents they or the subrecipients ensure Owner/Landlord complies with Lead Safe Housing Rule and Lead Disclosure Rule
	1. Property receiving less than or equal to \$5,000 per unit	Pre-1978	<ul style="list-style-type: none"> ◆ Safe work practices in rehab. ◆ Repair disturbed paint. ◆ Passing clearance exam of the worksite. 	
	2. Property receiving more than \$5,000 and up to \$25,000	Pre-1978	<ul style="list-style-type: none"> ◆ Risk assessment. ◆ Interim controls. ◆ Passing clearance exam. 	
	3. Property receiving more than \$25,000 per unit	Pre-1978	<ul style="list-style-type: none"> ◆ Risk assessment. ◆ Abatement of LBP hazards. ◆ Passing clearance exam. 	
K	Acquisition, Leasing, Support Services, or Operation	Pre-1978	<ul style="list-style-type: none"> ◆ Provision of pamphlet. ◆ Visual assessment. ◆ Paint stabilization. ◆ Passing clearance exam. ◆ Notice to occupants. ◆ Ongoing LBP maintenance. 	Have system in place that documents they ensure Owner/Landlord complies with Lead Safe Housing Rule and Lead Disclosure Rule

SUMMARY OF LEAD SAFE HOUSING RULE REQUIREMENTS			
Subpart of Rule/ Type Program	Year Built	Owner/Landlord Requirements ^{1, 2, 3}	Participant Monitoring Requirements
L Public Housing	Pre-1978	<ul style="list-style-type: none"> ◆ Provision of pamphlet. ◆ LBP inspection. ◆ Risk assessment if LBP not yet abated. ◆ Interim controls if LBP not yet abated. ◆ Abatement of LBP and LBP hazards. ◆ Passing clearance exam. ◆ Notice to occupants. ◆ Ongoing LBP maintenance and reevaluation until abatement. ◆ Ongoing LBP maintenance if abate using encapsulation or enclosure ◆ Response to EIBLL child.⁵ 	Have system in place that documents they ensure Owner/Landlord complies with Lead Safe Housing Rule and Lead Disclosure Rule
M Tenant-Based Rental Assistance for units already occupied or to be occupied by children under 6 years of age	Pre-1978	<ul style="list-style-type: none"> ◆ Provision of pamphlet. ◆ Visual assessment. ◆ Paint stabilization. ◆ Passing clearance exam. ◆ Notice to occupants. ◆ Ongoing LBP maintenance. ◆ Response to EIBLL child.⁵ 	Have system in place that documents they ensure Owner/Landlord complies with Lead Safe Housing Rule and Lead Disclosure Rule

- ¹ Perform and document clearance, lead-safe work practices and occupant protection, which are always required after abatement, interim controls, paint stabilization, or standard treatments, except when the amount of deteriorated paint is below the *de minimis* levels specified in Subpart R of the rule.
- ² Provide and document providing notice to occupants that includes results of evaluations (paint testing, inspection, and risk assessment) and clearance, where applicable.
- ³ *Training requirements.* See www.hud.gov/offices/lead for information. See www.epa.gov/lead for information and, in particular certification requirements; note that certification is issued by the EPA, or by the EPA-authorized State or Tribe with the authority to implement the certification for the jurisdiction in which the evaluation or hazard control work is to be conducted):

Evaluation and related activities:

Visual assessment: Online HUD visual assessment course, or risk assessment certification.

Inspection: LBP inspection certification.

Risk assessment, lead hazard screen, or re-evaluation: Risk assessment certification.

Clearance: LBP inspection, or risk assessment certification, or, for clearance after renovation, repair or painting work (but not abatement), sampling technician certification.

Hazard Control (other than small (de minimis) amounts of paint disturbance – see 24 CFR 35.1350(d)):

Repair of paint, paint stabilization, or interim control: Project supervisor being a certified renovator, and all additional workers being either certified renovators or having passed a HUD-approved lead-safe work practices course.

Abatement: Project supervisor being a certified abatement supervisor, and all additional workers being certified abatement workers.

- ⁴ See 24 CFR 35.115 for exemptions.
- ⁵ Environmental Intervention Blood Lead Level: A confirmed concentration of lead in whole blood of a child under age 6 of at least 20 micrograms of lead per deciliter ($\mu\text{g}/\text{dL}$) for a single test, or 15-19 $\mu\text{g}/\text{dL}$ in two tests taken at least 3 months apart. (While the term and its definition were based on guidance from the Centers for Disease Control and Prevention, in 2012 CDC revised its guidance, and it is anticipated that the EIBLL provisions of Lead Safe Housing Rule may be reconsidered at some point. See Chapter 16.)
- ⁶ Field Office monitoring areas of interest: covered program responsibility, partnerships, information management (monitoring, data processing, tracking), reporting and responding, and resources.

EPA's Lead-based Paint Activities Training and Certification Rule (40 CFR 745, subpart L)

On August 29, 1996, the EPA published a rule for the certification and training of lead-based paint professionals (61 FR 45778). Lead-based paint professionals include abatement personnel, project designers, lead-based paint inspectors and lead-based paint risk assessors. Lead-based paint activities include abatement, inspection and risk assessment. This rule contains the requirements for certification of lead-based paint abatement and evaluation firms and individuals, requirements for training providers, and work practice standards. As of July 2012, 39 States, the District of Columbia, Puerto Rico, and three Indian tribes have applied for and received authorization to run their own EPA-approved lead-based paint certification programs that are at least as protective of public health and the environment as the model program that EPA provided and uses for operating its certification program directly.

After the federal program became effective in non-authorized states and tribal areas on August 29, 1998, the rule also provided for an additional phase-in period there for the requirements for training program accreditation, individual and firm certification, and work practice standards. After March 1, 1999, training programs could no longer provide, offer, or claim to provide training or refresher training for lead-based paint activities defined at 40 CFR 745.223 there without being accredited by EPA according to the requirements of section (§) 745.225. In addition, after August 30, 1999, no individuals or firms could perform, offer, or claim to perform lead-based paint activities as defined at § 745.223 there without certification from EPA under § 745.226 to conduct those activities. (More information on training and the certification/accreditation process is available at: <http://www.epa.gov/lead/pubs/traincert.htm>.)

EPA's Lead Renovation, Repair and Painting Rule (40 CFR 745, primarily in Subpart E, Residential Property Renovation, with some provisions in Subparts L and Q)

The Renovation, Repair, and Painting (RRP) Rule was issued by the EPA under sections 402 and 406 of the Toxic Substances Control Act (15 U.S.C. §§ 2682 and 2686). It applies to most renovation, repair and painting projects (for brevity, EPA calls these projects "renovations") performed for compensation that disturb paint that is known or presumed to be lead-based paint in target housing and child-occupied facilities first constructed before 1978. In general, the RRP Rule requires that RRP work in these homes and facilities be conducted by certified renovation firms and supervised by a certified renovator assigned to the project, with occupants (or the families/guardians of children at the child-occupied facilities) being notified of the work, with the certified renovator on the job site at least when specified critical steps are taken, with the work being done using lead-safe work practices, and with the project completion determined by the certified renovator conducting a specific "cleaning verification" protocol that the work area has to pass. The cleaning verification protocol involves a visual inspection for residue, and, if none is observed, wiping the windowsills, countertops, and uncarpeted floors in the work area with disposable cleaning cloths, and comparing color of the wipes to a specified level of grayness on an EPA standard cleaning verification card.

The RRP Rule changed several subparts of 40 CFR 745, especially subpart E, Residential Property Renovation, when it was issued (73 FR 21692-21769, April 22, 2008). The RRP rule has been amended several times since (through the publication of this edition of these *Guidelines*, amendments had been published at 74 FR 34257-34262, July 15, 2009; 75 FR 24802-24819, May 6, 2010; and 76 FR 47918-47946, August 5, 2011). For further details on the RRP Rule's development, see the EPA's Renovation, Repair and Painting page, <http://www.epa.gov/lead/pubs/renovation.htm>. For the annual edition of 40 CFR 745, reflecting all amendments up to the time of publication of the latest edition, see the General Printing Office's Federal Digital System website, <http://www.fdsys.gov> or <http://www.gpo.gov/fdsys/>. (As of 2012, the search involves clicking on the right column's Featured Collection of the Code of Federal Regulations, then, within that collection, searching for the current year, then Title 40, then Chapter 1, then Subchapter R, then Part 745.)

The purpose of the RRP Rule is to ensure the following:

- ◆ Owners and occupants of target housing and child-occupied facilities receive information on lead-based paint hazards before these renovations begin; and
- ◆ Individuals performing renovations regulated in accordance with §745.82 are properly trained; renovators and firms performing these renovations are certified; and the work practices in §745.85 are followed during these renovations.

The RRP Rule requires that contractors performing most renovation, repair or painting projects that disturb paint in target housing of child-occupied facilities that is known or presumed to be lead-based paint provide to owners and occupants of the target housing and child-occupied facilities built before 1978, and to parents and guardians of children under age six that attend these facilities the lead hazard information pamphlet. As of 2011, the pamphlet for renovations is available from EPA and HUD in English, as [Renovate Right: Important Lead Hazard Information for Families, Child Care Providers, and Schools](#), and in Spanish, as [Remodelar Correctamente: Guía de Prácticas Acreditadas Seguras para Trabajar con el Plomo para Remodelar Correctamente](#). The rule affects paid workers who do RRP work in pre-1978 housing and child-occupied facilities, including:

- ◆ Renovation contractors;
- ◆ Maintenance workers in multi-family housing; and
- ◆ Painters and other specialty trades; among others;

and the firms that hire them or otherwise contract or subcontract for their RRP services.

Under the rule, child-occupied facilities are defined as residential, public or commercial buildings where children under age six are present on a regular basis. The requirements apply to renovation, repair or painting activities. The RRP rule does not apply to minor repair and maintenance activities where up to six square feet of lead-based paint is disturbed in a room, or up to 20 square feet of lead-based paint is disturbed on the exterior, where none of the work practices prohibited or restricted by the rule (at 40 CFR 745.85(a)(3)) are used and where the work does not involve window replacement. Property owners and contractors who perform these projects in pre-1978 rental housing or space rented by child-care facilities must be certified and follow the lead-safe work practices required by the RRP Rule. (Property owners who work on the homes in which they reside are exempt from the rule. If this housing in which the owner reside has additional dwelling units the owner rents out, the owners are covered by the rule for work on the rental units or those units' exteriors, to the same extent as contractors they would hire to do that work.) To become certified, property owners and contractors must submit an [application for firm certification](#) and fee payment to EPA or, if the State or Tribe is authorized by EPA to operate the RRP certification program, to the State or Tribe directly. As of July 2012, 12 states had this authority. The EPA or EPA-authorized State or Tribe has up to 90 days after receiving a complete request for certification to approve or disapprove the application.

Differences between HUD's LSHR and EPA's RRP Rule

A description of requirements under HUD's LSHR as it was in place before the EPA RRP Rule went into effect, and the corresponding requirements of EPA's RRP Rule, and the changes for HUD LSHR projects resulting from the implementation of the RRP Rule, are summarized in the following table and explained in the narrative following the table:

Differences between HUD LSHR and EPA RRP regulations

Stage of Job	Requirement	HUD LSHR before EPA RRP Rule went into effect	EPA RRP Rule	Changes to LSHR projects to incorporate RRP Rule.
Planning and Set-Up	Determination that lead-based paint (LBP) is present.	Only a certified LBP inspector or risk assessor may determine whether LBP is present. EPA-recognized test kits cannot be used to determine that paint is not LBP.	Certified renovators use an EPA-recognized test kit, or a certified LBP inspector or risk assessor makes a determination of whether LBP is present.	No change.
	Training	<p>HUD does not certify renovators or firms.</p> <p>HUD generally requires all workers and supervisors to successfully complete a HUD-approved curriculum in lead-safe work practices, such as the EPA/HUD initial RRP curriculum, except that uncertified workers supervised by a certified LBP abatement supervisor need only project-specific on-the-job training. The EPA/HUD initial RRP curriculum is approved by HUD under the LSHR, as are others listed at www.hud.gov/offices/lead/training/hudtraining.pdf.</p>	<p>EPA or EPA-authorized States certify renovation firms and accredit training providers that certify renovators. Only the certified renovator is required to have classroom training. Workers must receive on-the-job training from the certified renovator.</p> <p>Workers who passed one of the lead-safe work practices listed at www.epa.gov/lead/pubs/trainerinstructions.htm (including a certified LBP abatement supervisors) before October 4, 2011 may become certified renovators by taking either the 4-hour RRP refresher or the 8-hour initial RRP course.</p> <p>Certified LBP inspectors and risk assessors may act as certified dust sampling technicians without further training.</p> <p>People who passed an accredited LBP inspector or risk assessor course before October 4, 2011, but are not certified in those disciplines, may become a certified dust sampling technician by taking either the dust sampling technician refresher or the initial training.</p>	Renovation firms must be certified. At least one certified renovator must be at the job or available when work is being done. Not all workers need to be certified renovators.

Stage of Job	Requirement	HUD LSHR before EPA RRP Rule went into effect	EPA RRP Rule	Changes to LSHR projects to incorporate RRP Rule.
Planning and Set-Up (cont.)	Pre-Renovation Education	HUD requires conformance with EPA (and other agencies') regulations, including EPA's Pre-Renovation Education Rule. Before December 22, 2008, EPA and HUD had required renovators to hand out the EPA / HUD / CPSC <i>Protect Your Family from Lead in Your Home</i> (Lead Disclosure Rule) pamphlet.	Renovators must hand out the EPA / HUD <i>Renovate Right: Important Lead Hazard Information for Families, Child Care Providers and Schools</i> pamphlet. (This requirement went into effect on December 22, 2008.)	LSHR requires <i>Renovate Right</i> to be handed out.
During the Job	Treating LBP hazards	Depending on type and amount of HUD assistance, HUD requires that lead hazards be treated using "interim controls," "ongoing lead-based paint maintenance," or abatement.	EPA does not require that LBP hazards be treated, only how they are treated when this is done. In general, EPA requires that renovations in target housing be performed using lead-safe work practices by certified renovation firms and certified renovators (with exceptions, such as for minor repair and maintenance projects [see below] and projects that do not disturb known or presumed LBP). When the intent of work is to eliminate the hazards or the LBP for reasons of lead safety, the work is abatement, and certified abatement contractors, certified supervisors and certified workers must be used.	Certified renovation firms and certified renovators must be used for most interim control and ongoing LBP maintenance projects. (The requirements for abatement projects are unchanged.)

Stage of Job	Requirement	HUD LSHR before EPA RRP Rule went into effect	EPA RRP Rule	Changes to LSHR projects to incorporate RRP Rule.
During the Job (cont.)	Prohibited Work Practices	HUD prohibits 6 work practices. These include EPA's 3 prohibited work practices plus: heat guns that char paint, dry scraping or sanding farther than 1 ft. of electrical outlets, and use of a volatile stripper in poorly ventilated space.	EPA prohibits 3 work practices (open flame burning or torching, heat guns above 1100 degrees F, machine removal without HEPA vacuum attachment).	None.
	Threshold minimum amounts of interior paint disturbance which trigger lead activities.	HUD has a smaller interior " <i>de minimis</i> " threshold (2 sq. ft. per room, or 10% of a small component type) than EPA for lead-safe work practices. HUD also uses this smaller threshold for clearance and occupant notification.	EPA's interior threshold (6 sq. ft. per room) for minor repair and maintenance activities is larger than HUD's <i>de minimis</i> threshold.	None.
End of Job	Confirmatory Testing	HUD requires a clearance examination done by an independent party instead of the certified renovator's cleaning verification procedure.	EPA allows cleaning verification by the renovator or clearance examination if required by regulation or contract. The cleaning verification does not involve sampling and laboratory analysis of the dust.	None.
	Notification to Occupants	HUD requires the designated party to distribute notices to occupants' units or by posting in centrally located common areas, within 15 days after lead hazard evaluation (or presumption) and control activities in their unit or common areas they access).	EPA has no requirement to notify residents after the renovation, unless they contracted for the renovation, in which case they get the clearance results within 30 days after the renovation is completed.	None.

A. Responsibilities Shifted from the Renovator to the Designated Party under HUD's LSHR:

1. Under the LSHR, the designated party is generally responsible to either have the paint tested by a certified lead inspector or risk assessor or presume the presence of lead-based paint. Therefore, when HUD's rule applies, the Certified Renovator may **not** use a paint test kit to determine that the paint is **not** lead-based paint. Note: Some states may have conflict-of-interest regulations prohibiting renovators from testing paint on which they will be working.
2. When the HUD LSHR applies, the designated party must have a qualified person, independent of the renovation firm, conduct a lead clearance examination. The Certified Renovator does not conduct a cleaning verification. See below for more information on clearance testing.

B. Additional HUD Requirements for the Renovator:

1. **Training requirements for workers and supervisors performing interim controls.** To meet the requirements of both rules:
 - a. If the supervisor (in HUD terms) was certified before October 4, 2011 as a lead-based paint abatement supervisor or had successfully completed an accredited abatement supervision or abatement worker course before that date, that person must complete a 4-hour RRP refresher course to become a Certified Renovator.
 - b. For workers who are not themselves supervisors / Certified Renovators:
 - ◆ If their supervisor on this project is a certified lead-based paint abatement supervisor who has completed a 4-hour RRP refresher course, thereby becoming a Certified Renovator, the workers must obtain on-the-job training in lead-safe work practices from the supervisor; unless,
 - ◆ The workers must successfully complete either a one-day RRP course, or another lead-safe work practices course approved by HUD for this purpose after consultation with the EPA. HUD has approved the one-day RRP course, the previously-published HUD/EPA one-day Renovation, Remodeling and Repair course, and other one-day courses listed on HUD's website, at www.hud.gov/offices/lead/training/hudtraining.pdf. Note that if the workers had completed some of these courses, the ones listed at www.epa.gov/lead/pubs/trainerinstructions.htm before October 4, 2011, they may become certified renovators by taking either the 4-hour RRP refresher or the 8-hour initial RRP course.
 - c. Where the work is being done in a State or Tribal jurisdiction that has been authorized by the EPA to operate an RRP training and certification program, the one-day RRP course and half-day RRP refresher course must be accredited by the State or Tribe. HUD will approve all one-day RRP courses accredited by EPA-authorized States or Tribes.
 - d. The 4-hour RRP refresher course is not sufficient on its own to meet either the EPA or HUD training requirements.

2. **The certified renovation firm and the certified renovator must take additional precautions to protect residents from lead poisoning beyond those in EPA's RRP Rule.**
 - a. **Renovators must use lead-safe work practices in work exempt from the RRP Rule that:**
 - ◆ Disturbs between 2 and 6 square feet of paint per room, and so is above the LSHR's *de minimis* threshold but below the RRP's minor repair and maintenance activities threshold.

Note: Window replacement, window sash replacement, and demolition of painted surface areas disturb more paint than the LSHR's de minimis threshold, even without a calculation of the paint area disturbed.
 - ◆ Disturbs more than 10% of a component type with a small surface area (such as window sills, baseboards, and trim).
 - b. **Not using HUD's three additional prohibited work practices**, in addition to not using EPA's three prohibited work practices (open flame burning or torching, heat guns above 1100 degrees F, and machine removal without HEPA vacuum attachment):
 - ◆ Heat guns that char the paint even if operating at below 1100 degrees F.
 - ◆ Dry sanding or dry scraping, except dry scraping in conjunction with heat guns or within 1 ft of electrical outlets.
 - ◆ Paint stripping using a volatile stripper in a poorly ventilated space.
 - c. **Taking additional measures to protect occupants** during longer interior hazard reduction activities: Temporarily relocating the occupants before and during longer interior hazard reduction activities to a suitable, decent, safe, and similarly accessible dwelling unit that does not have lead-based paint hazards. Temporary relocation is not required for shorter projects, where:
 - ◆ The work is contained, completed in one period of 8-daytime hours, and does not create other safety, health or environmental hazards; or
 - ◆ The work is completed within 5 calendar days, after each work day, the worksite and the area within 10 feet of the containment area are cleaned of visible dust and debris, and occupants have safe access to sleeping areas, and bathroom and kitchen facilities.

C. Additional Designated Party Responsibilities that may Affect the Renovator

On jobs covered by the HUD LSHR, the certified renovation firm and the certified renovator should know other requirements for the designated party that may affect their role on the project.

1. **Designated party must provide occupants with two notices, if the amount of work is above HUD's *de minimis* threshold:**
 - a. **NOTICE OF EVALUATION OR PRESUMPTION:** This notice informs the occupants that paint has been evaluated to determine if it is LBP or that paint has been presumed to be LBP. The designated party must notify the occupants within 15 calendar days of receiving the evaluation report or making the presumption. The renovator should ask the

client if he/she has made this notice. The owner may provide a copy of this notice to the renovator so the renovator knows where LBP is located.

- b. **NOTICE OF HAZARD REDUCTION ACTIVITY:** This notice describes the hazard reduction work that was completed, information on the location of any remaining LBP, the date of the notice, and the contact for occupants to get more information. The designated party must notify the occupants within 15 calendar days of completing the hazard reduction work. The renovator may be given a copy of this notice, or may be asked to prepare or distribute the notice for the owner as part of the renovator's work for the owner.

2. Depending on the type and amount of housing assistance provided, HUD generally requires that identified LBP hazards be treated.

Treatments may include LBP hazard abatement, interim controls or ongoing LBP maintenance. Renovators should inquire if their contract with the owner requires them to perform lead hazard treatment tasks listed below. If so, all workers and supervisors must have the proper training and qualifications. Generally, interim controls include the following activities, which are required if the amount of work is above HUD's *de minimis* threshold; for work below the *de minimis* threshold, any deteriorated paint must be repaired, but the work need not be done using lead-safe work practices, although HUD strongly encourages their use:

- a. Deteriorated LBP must be stabilized. This means that physical defects in the substrate of a paint surface or component that is causing the deterioration of the surface or component must also be repaired.
- b. Friction surfaces that are abraded must be treated if there are lead dust hazards nearby.
- c. Friction points must be either eliminated or treated so the LBP is not subject to abrasion.
- d. Impact surfaces must be treated if the paint on an impact surface is damaged or otherwise deteriorated and the damage is caused by impact from a related building component (such as a door knob that knocks the wall or a door that rubs against its door frame).
- e. LBP must be protected from impact.
- f. Chewable LBP surfaces must be made inaccessible for chewing by children of less than six years of age if there is evidence that such a child has chewed on the painted surface.
- g. Horizontal surfaces that are rough, pitted, or porous must be covered with a smooth, cleanable covering or coating.

3. For certain types of HUD assistance, when a child known to have an environmental intervention blood lead level is present, the designated party must take additional steps to assess the situation and respond to potential lead hazards.

An environmental intervention blood lead level (as of the publication of this edition of these *Guidelines*) is a confirmed reading in a child under 6 years old of 20 micrograms per deciliter of blood (20 µg/dL), or two readings of 15 to 19 µg/dL at least 3 months apart. For certain types of HUD assistance (tenant-based rental assistance, project-based rental assistance, public housing, and HUD-owned multi-family housing), the owner or designated party may ask the renovator to perform work in the unit to address specific lead hazards identified by an

environmental investigation risk assessment. All persons participating in such work should have appropriate training and qualifications.

4. The designated party must arrange for someone independent of the renovator to conduct a clearance examination, if the amount of work is above HUD's *de minimis* threshold:

- a. A clearance examination includes a visual assessment at the end of the renovation work for deteriorated paint, dust, debris, paint chips or other residue; sampling of dust on interior floors, window sills and window troughs; submitting the dust samples to a laboratory for analysis for lead; interpreting the lab results, and preparing a clearance report. EPA also allows a clearance examination to be used instead of the post-cleaning verification, if the clearance examination is required by federal, state or local regulations or by the contract. The unit – or, where work is contained, just the work area and an area just outside the containment – must pass clearance, and must not have any remaining lead hazards. If clearance fails at either the visual assessment step or the dust testing step, cleaning has to be redone in the failed part of the work area. The failed part of the work area is the specific area that was tested, as well as any areas that were not tested, and any other areas that are being represented by the sampled area. For example:
 - ◆ Just one bedroom was tested, because it was to represent all bedrooms in the housing unit; it failed. Therefore, all of the bedrooms in the unit have to be re-cleaned and re-cleared.
 - ◆ In a large multi-family apartment building, if a percentage of units are tested in accordance with the HUD Guidelines, if any fail, all of the units except those that passed clearance have to be re-cleaned and re-cleared. (If there are patterns of just certain component types failing, just those component types need to be re-cleaned and re-cleared in the failed and untested units.)
- b. The person conducting the clearance examination must be both:
 - ◆ A certified lead-based paint inspector, risk assessor, clearance examiner, or dust sampling technician, depending on the type of activity being performed. (Either the State or the EPA certifies this person, depending on whether or not the State the housing is in is authorized by EPA to certify people in the lead discipline.)
 - ◆ Independent of the organization performing hazard reduction or maintenance activities. There is one exception, which is that designated party may use a qualified in-house employee to conduct clearance even if other in-house employees did the renovation work, but an in-house employee may not do both renovation and clearance.

D. How to Find Out About Lead-Based Paint Requirements that Apply to Planned Work in Properties Receiving HUD Housing Assistance, such as Rehabilitation or Acquisition Assistance:

Finding out whether the work is receiving federal housing assistance is important because failing to meet lead-based paint requirements could affect the continuation of the assistance. For each job, the renovation firm should find out whether:

- ◆ The housing receives financial assistance; and

- ◆ Any lead-based paint requirements apply to the work because of the assistance provided.

The renovation firm should take the following steps:

1. Ask the property owner if the property or the family receives any type of housing assistance, including low-interest loans, from a local, State, or Federal agency. If so:
 - ◆ Find out the name of the agency, contact person, address and phone number. (See the list of types of agencies below.)
 - ◆ Get a basic description of the type of assistance the property receives.

Note: You should be able to explain to the owner that there will be information about the work that you will need, and that you also need to check if there are any special requirements.

2. If you have any questions about the Federal or State lead-based paint requirements that apply to the work, contact the public agency administering the assistance and discuss the project with the program specialist or rehabilitation specialist working with the property. For example:
 - ◆ Some types of public agencies administering housing assistance, such as rehabilitation or acquisition assistance, include:
 - State Housing Agency, Corporation or Authority
 - State Community Development Agency, Corporation or Authority
 - State Housing Finance Agency
 - City or County Housing Authority, Corporation or Authority
 - City or County Community Development Agency, Corporation or Authority
 - USDA Service Center – Rural Housing Programs
 - ◆ Is the project considered lead abatement?
 - If so, what are the agency's abatement requirements?
 - If the project is not abatement, what are the agency's lead-based paint requirements for the project, and how should they be incorporated into the work write-up?

EPA's Pre-Renovation Education (PRE) Regulation (40 CFR 745, subpart E)

EPA's PRE home page can be accessed at: <http://www.epa.gov/lead/pubs/leadrenf.htm>. Section 406 of TSCA directed EPA to develop requirements for renovators to distribute a lead hazard information pamphlet to housing owners and occupants before conducting renovations in pre-1978 housing. The Lead Renovation, Repair and Painting (RRP) rule amends and supplements the 1999 PRE rule.

Since June 23, 2008, renovators have been required to distribute a lead hazard information pamphlet to the owners and administrators of child-occupied facilities before beginning renovations in these facilities. Renovators must also make renovation information available to the parents or guardians of children under age six that attend these facilities. As defined in the rule, child-occupied facilities are residential, public or

commercial buildings built before 1978 where children under age six are present on a regular basis. Child care facilities and kindergarten and pre-kindergarten classrooms are examples of child-occupied facilities. Since December 22, 2008, contractors have had to use the new renovation-specific lead hazard information pamphlet, entitled *Renovate Right: Important Lead Hazard Information for Families, Child Care Providers and Schools*, to comply with these requirements. For more information, visit EPA's [Renovation, Repair, and Painting web page](#), or contact the [National Lead Information Center \(NLIC\)](#) at 1-800-424-LEAD [5323] to speak with an information specialist. If you are a hearing- or speech-impaired person, you may reach the above telephone number through TTY by calling the toll-free Federal Relay Service at 800-877-8339.

OSHA's Lead Regulations (29 CFR 1910.1025 and 29 CFR 1926.62)

OSHA's lead regulations are described at OSHA's main lead regulation web page at: <http://www.osha.gov/SLTC/lead/>. **Note:** As of July 2012, 25 states, Puerto Rico and the Virgin Islands had [OSHA-approved State Plans](#) and had adopted their own standards and enforcement policies. For the most part, these States adopted standards to Federal OSHA's. However, some States have adopted different standards or have different enforcement policies.

OSHA has two lead standards, one for construction and one for general industry. The two standards complement each other; the first covers construction work (construction, alteration, repair, painting and/or decorating (29 CFR 1926.10, (a))), while the second covers work that is not construction work (such as maintenance work not related to construction) and that is not maritime work (i.e., shipyard, marine terminal, or longshoring work). Employers are responsible for determining which standard applies to their workers on a particular project. See Chapter 9, Worker Protection, for information on how the OSHA standards relate to the HUD and EPA lead regulations, and for HUD's recommendations on worker protection even for activities not covered by HUD or EPA regulations.

OSHA's **Lead in General Industry Standard** (29 CFR 1910.1025) covers the use of lead in general industry. This industry includes non-construction-related maintenance work, as well as lead smelting, manufacturing and the use of lead-based pigments contained in inks, paints and other solvents in addition to the manufacturing and recycling of lead batteries. A compliance advisor is available for the Lead in General Industry Standard at <http://www.osha.gov/dts/osta/oshasoft/gilead.html>.

Maintenance work associated with construction, alteration or repair activities is covered by the Construction Standard (29 CFR 1926.62, subsection (a), as discussed below). Non-construction-related maintenance work (such as maintenance activities associated with operations, or if lead is a component of any product that workers make or use) is covered by the General Industry Standard (29 CFR 1910.1025(e)(3)(ii)(A)). Construction activities do not include routine cleaning and repainting (for example, minor surface preparation and repainting of rental apartments between tenants or at scheduled intervals) where there is insignificant damage, wear, or corrosion of existing lead-containing paint and coating or substrates. Maintenance activities covered by the General Industry Standard are those which involve making or keeping a structure, fixture, or foundation in proper condition in a routine, scheduled, or anticipated fashion.

OSHA's **Lead in Construction Standard** (29 CFR 1926.62) applies to all construction work where an employee may be occupationally exposed to lead. OSHA has published a 332-page booklet on this regulation (OSHA 3142-09R 2003), posted at <http://www.osha.gov/Publications/osha3142.pdf>. OSHA has also posted an on-line interactive expert system (compliance advisor) on the Lead in Construction Standard at <http://www.dol.gov/elaws/oshalead.htm>.

The Lead in Construction Standard applies to any source or concentration of lead to which workers may be exposed as a result of construction work. OSHA standards are not limited to lead-based paint as defined by

HUD or EPA, or lead-containing paint as defined by or the Consumer Product Safety Commission (CPSC). Several letters of interpretation are accessible from OSHA's lead home page (<http://www.osha.gov/SLTC/lead/index.html#standards>) including a letter of interpretation dated July 18, 2003, posted at http://www.osha.gov/pls/oshaweb/owadisp.show_document?p_table=INTERPRETATIONS&p_id=24601, which states that Lead Check and Lead Alert spot test kits are not sufficient for an employer to rule out the possibility of employee exposure to lead.

OSHA's lead in construction standard applies to all construction work where an employee may be exposed to lead. All work related to construction, alteration, or repair, including painting and decorating, is included. Under this standard, construction includes, but is not limited to:

- ◆ Demolition or salvage of structures where lead or materials containing lead are present;
- ◆ Removal or encapsulation of materials containing lead;
- ◆ New construction, alteration, repair, or renovation of structures, substrates, or portions or materials containing lead;
- ◆ Installation of products containing lead;
- ◆ Lead contamination from emergency cleanup;
- ◆ Transportation, disposal, storage, or containment of lead or materials containing lead where construction activities are performed; and
- ◆ Maintenance operations associated with these construction activities.

Construction work is defined as work for construction, alteration and/or repair, including painting and decorating. All construction work with the potential for lead exposures excluded from coverage in the general industry standard for lead by 29 CFR 1910.1025(a)(2) is covered by the lead in construction standard. The construction standard establishes maximum limits of exposure to lead for all workers covered, including a permissible exposure limit (PEL) and action level (AL). The PEL sets the maximum worker exposure to lead: 50 micrograms of lead per cubic meter of air (50 $\mu\text{g}/\text{m}^3$) averaged over an eight-hour period. If employees are exposed to lead for more than eight hours in a workday, their allowable exposure as a TWA for that day must be reduced according to this formula:

Employee exposure (in $\mu\text{g}/\text{m}^3$) = 400 divided by the hours worked in the day.

The Action Level, regardless of respirator use, is an airborne concentration of 30 $\mu\text{g}/\text{m}^3$, averaged over an eight-hour period. The Action Level is the level at which an employer must begin specific compliance activities outlined in the standard. Additional compliance activities are required when the exposure exceeds the PEL.

Employers of construction workers are responsible for developing and implementing a worker protection program. At a minimum, the employer's worker protection program for employees exposed to lead must address those requirements that apply no matter what lead exposure is. As noted by OSHA in its 2003 informational booklet "Lead in Construction" (OSHA Publication 3142-09R; <http://www.osha.gov/Publications/osha3142.html> and <http://www.osha.gov/Publications/osha3142.pdf>.)

- ◆ The employer must maintain any employee exposure and medical records to document ongoing employee exposure, medical monitoring, and medical removal of workers. This data provides a baseline to evaluate the employee's health properly. Employees or former employees, their designated representatives, and OSHA must have access to exposure and medical records in accordance with 29 CFR 1910.1020. Rules of agency

practice and procedure governing OSHA access to employee medical records are found in 29 CFR 1913.10.

- ◆ If the initial assessment indicates that no employee is exposed above the AL, the employer may discontinue monitoring. Further exposure testing is not required unless there is a change in processes or controls that may result in additional employees being exposed to lead at or above the AL, or may result in employees already exposed at or above the AL being exposed above the PEL. The employer must keep a written record of the determination, including the date, location within the work site, and the name and social security number of each monitored employee.

In regard to an employee's exposure to lead in air being at or above the AL, certain compliance activities are required, including:

- ◆ For an employee exposed to lead on the job at or above the AL on any one day per year, the employer must make available, at no cost to the employee, initial medical surveillance.
- ◆ For an employee exposed to lead on the job at or above the AL for more than 30 days in any consecutive 12 months, the employer must make available, at no cost to the employee:
 - A medical surveillance program with biological monitoring and provisions for medical removal:
 - ◆ At least every two months for the first six months and every six months thereafter;
 - ◆ At least every two months for employees whose last blood sampling and analysis indicated a blood lead level (BLL) at or above 40 µg/dL; and
 - ◆ At least monthly while an employee is removed from exposure due an elevated BLL.
 - An immediate medical consultation when the employee notifies the employer that the employee:
 - ◆ Has developed signs or symptoms commonly associated with lead-related disease;
 - ◆ Has demonstrated difficulty in breathing during respirator use or a fit test;
 - ◆ Desires medical advice concerning the effects of past or current lead exposure on the employee's ability to have a healthy child; and
 - ◆ Is under medical removal and has a medically appropriate need.
 - Medical removal from work with an exposure at or above the AL when:
 - ◆ A periodic and a follow-up blood sampling test indicate that the employee's BLL is at or above 50 µg/dL; or
 - ◆ A final medical determination has been made that the employee has a detected medical condition which places the employee at increased risk of material impairment to health from exposure to lead.

The worker protection program must address additional requirements if the lead exposure to lead in air is above the PEL, including:

- ◆ Hazard determination, including exposure assessment, and notifying employees of results.
- ◆ Medical surveillance and provisions for medical removal.
- ◆ Job-specific compliance programs.

- ◆ Engineering and work practice controls.
- ◆ Respiratory protection.
- ◆ Protective clothing and equipment.
- ◆ Housekeeping.
- ◆ Hygiene facilities and practices.
- ◆ Signs.
- ◆ Employee information and training (Note: This training is different than HUD or EPA training. For more information, contact your OSHA regional office (<http://www.osha.gov/html/RAmap.html>)).
- ◆ Recordkeeping.

For each job where employee exposure exceeds the PEL, the employer must establish and implement a written compliance program to reduce employee exposure to the PEL or below. The compliance program must provide for frequent and regular inspections of job sites, materials, and equipment by a competent person. Written programs, which must be reviewed and updated at least every six months, must include:

- ◆ A description of each activity in which lead is emitted (such as equipment used, material involved, controls in place, crew size, employee job responsibilities, operating procedures, and maintenance practices);
- ◆ The means to be used to achieve compliance and engineering plans and studies used to determine the engineering controls selected, where they are required;
- ◆ Information on the technology considered to meet the PEL;
- ◆ Air monitoring data that document the source of lead emissions;
- ◆ A detailed schedule for implementing the program, including copies of documentation (such as purchase orders for equipment, construction contracts);
- ◆ A work practice program;
- ◆ An administrative control schedule, if applicable; and
- ◆ Arrangements made among contractors on multi-contractor sites to inform employees of potential lead exposure.

Consumer Product Safety Commission Ban of Lead-Containing Paint and Lead in Consumer Products Used by Children (16 CFR Part 1303)

In 1978, the U.S. Consumer Product Safety Commission lowered the legal maximum lead content in most kinds of paint to 0.06% of the weight of the total nonvolatile content of the paint or the weight of the dried paint film (which paint and similar surface-coating materials are referred to as "lead-containing paint"). The Commission issued the 1978 ban because it found that there was an unreasonable risk of lead poisoning in children associated with lead content of over 0.06% in paints and coatings to which children have access and that no feasible consumer product safety standard under the Consumer Product Safety Act would adequately protect the public from this risk.

Under section 101(f) of the Consumer Product Safety Improvement Act of 2008 (Pub. L. 110–314; see 15 U.S.C. 2051 note, via the U.S. Code search website, <http://uscode.house.gov/search/criteria.shtml>), this amount was reduced to 0.009% (90 parts per million) in consumer products.

The CPSC also bans:

- ◆ Toys and other articles intended for use by children that bear “lead-containing paint”.
- ◆ Furniture articles for consumer use that bear “lead-containing paint”.

The CPSC lead regulation is posted at: <http://www.gpo.gov/fdsys/pkg/CFR-2011-title16-vol2/xml/CFR-2011-title16-vol2-part1303.xml>.

For additional CPSC lead-related information, use the Find CPSC Product Safety Standards or Guidance search engine at: <http://www.cpsc.gov/cgi-bin/regs.aspx>.

National Park Service’s regulations on Protection of Historic Properties (36 CFR Part 800)

The ***National Historic Preservation Act of 1966 (NHPA)*** requires Federal agencies to take into account the effects of their undertakings on historic properties, and give the ***Advisory Council on Historic Preservation*** a reasonable opportunity to comment. The historic preservation review process mandated by Section 106 of the Act is outlined in regulations issued by ACHP. Revised regulations, “***Protection of Historic Properties***,” became effective January 11, 2001, with amendments effective August 5, 2004; the current regulations, at 36 CFR Part 800, are posted at <http://www.gpo.gov/fdsys/pkg/CFR-2011-title36-vol3/xml/CFR-2011-title36-vol3-part800.xml>, and summarized on the ACHP’s web page at: <http://www.achp.gov/106summary.html>.

See Chapter 18, Lead Hazard and Historic Preservation, of these *Guidelines*, and the National Park Service’s Preservation Brief 37, *Appropriate Methods for Reducing Lead-Paint Hazards in Historic Housing*, posted at <http://www.nps.gov/history/hps/tps/briefs/brief37.htm>, for further information and guidance on lead hazard evaluation and control considerations in historic properties.

Appendix 7.1: (reserved for future use)

Appendix 7.1 of the 1995 *Guidelines*, which was a list of elements of request for proposals (RFPs) for risk-assessment and lead-based paint inspection services, has been deleted. This guidance may be revised and inserted at a later date.

Please note that Appendix 7.3 has links to Department of Defense lead hazard control specifications.

Appendix 7.2:

Types of Lead-Based Paint Enclosure Systems

General Notes

The following notes apply to several of the Enclosure Systems used to seal interior and exterior surfaces of walls, ceilings, floors, doors, windows and trim which contain lead-based paint.

- A. Application of gypsum board, plywood paneling, or solid board paneling directly to existing wall or ceiling surfaces requires anchorage to structural wood or steel joists or ceiling joists or rafters by suitable screws penetrating the structure at least 3/4". Attachment may also employ a combination of screws and construction adhesive. For application directly to masonry surfaces, case-hardened masonry nails, of sufficient length to extend into the masonry, and construction adhesive are required.
- B. Furring may be required to produce a true and even support for panel or board finish materials. Furring may be wood 1" x 2", 2" x 2" strips or metal channels. Resilient metal channels may be used where additional sound attenuation is desired. Furring may be applied vertically or horizontally to accommodate the direction of the finish material. Furring shall be anchored to structural studs, ceiling joists or rafters preferably with bugle-head screws or annular-ringed nails; to steel studs or channel framing, anchorage shall be by bugle-head screws. Anchorage of furring strips to concrete or masonry walls shall be by case-hardened masonry nails, anchors, or toggle bolts. Furring shall not be more than 16" on center of walls or 24" on center for ceilings.
- C. Gypsum, cement, or metal lath shall be anchored to structural wood or steel studs, joints, or rafters, or to wood or metal furring by bugle-head screws. Anchorage of metal lath to concrete or masonry walls shall be by case-hardened masonry nails, power or hand drive.
- D. All enclosure systems (wood panels, boards, plaster and stucco systems, siding and tile) shall include the sealing of all joints, edges and corners with suitable materials. Penetrations of walls and ceilings serving electrical outlets, switches and fixtures, heating and cooling duct registers, plumbing and heating pipes shall be sealed by collars, foam or other approved devices to prevent dust from lead-based painted surfaces escaping enclosed surfaces. All sealing materials shall have an expected service life of a minimum of twenty years.
- E. Enclosing systems shall leave interior space dimensions, areas and ceiling heights sufficient to meet all building codes and minimum property standards. Exterior enclosure systems shall permit structures to meet zoning restriction for setback requirements.
- F. For enclosure systems which do not produce an air-tight enclosure such as plaster and stucco systems with control joints, wood paneling, and aluminum and vinyl siding, the covering of the surface by a breathable wrap such as Tyvek® should be required to prevent lead-containing dust particles from migrating. Where breathable cloth is used to enclose existing wall surfaces, required ventilation strips and openings shall not be covered but shall remain open.

1. Gypsum Board Applied Directly to Existing Walls or Ceiling Surfaces

Enclosure of lead-based paint on gypsum board or plaster surfaces may be achieved by application of 1/2" or 3/8" thick standard gypsum board directly to existing walls and ceilings. Gypsum board with tapered edges shall be attached with drywall screws or a combination of screws and construction adhesive. If quarter inch thick drywall is used, the surface to be enclosed must be essentially free of holes.

Screws shall be of sufficient length to pass through the existing drywall or plaster and intrude into the structural wood studs or ceiling joist 5/8" to 3/4".

Finishing materials including joint tape, corner and edge beading and spackle shall be as approved by gypsum board manufacturers and installed in accordance with their recommendations.

In high moisture areas, such as laundries and baths, moisture-resistant gypsum board shall be used. In bathtub or shower enclosures to be covered by tile, cement board shall be used.

All joints, corners, and edges and all surface penetrations for electrical outlets, switches, light fixtures, pipes and duct grilles and registers shall be sealed by means of collars, foam, or other approved devices to prevent dust from lead-contaminated surfaces from reaching newly enclosed areas.

Gypsum board shall be applied in accordance with the General Notes.

2. Gypsum Board Applied to Furring Strips

Where existing plaster or gypsum board surfaces are not suitable for direct application, a new layer of gypsum board may be applied over furring strips. Furring may be designated where the surface is uneven or has deteriorated or to cover existing surface moldings.

Furring may be wood 1" x 2" strips or metal channels shimmed as required to produce a true and even surface. Resilient metal channels may be used where additional sound attenuation is desired. The thickness of gypsum board shall be a minimum of one-half inch and spacing of furring shall meet industry standards.

Furring shall be anchored to structural studs, ceiling joists or roof rafters not more than 16" on center preferably with annular-ringed nails penetrating the members approximately three-quarters inch.

Gypsum board panels shall be applied to furring strips as described in Section 1 and in accordance with the General Notes.

3. Lath and Plaster Applied Directly to Existing Wall and Ceiling Surfaces

Where existing wall and ceiling surfaces are sound and even, enclosure may be achieved by application of expanded metal lath or gypsum lath and required base and finish plaster coats. Selection of a plaster system depends on the desired surface and finish characteristics such as a smooth, sanded, hard or moisture resistant. Plasters may be job-mixed or ready-mixed systems as needed to satisfy the requirement of the job. Job-mixed plasters include lime plasters, sand gauging plasters, and Keene's cement.

Lath systems include gypsum lath and a variety of metal laths. Gypsum lath is usually available in sheets 16" x 48". Lath shall be applied as described in the General Notes.

4. Lath and Plaster Applied over Furring strips

Where instability or unevenness of the existing surface requires, furring shall be installed prior to application of lath and plaster.

Furring may be 1" x 2" x 2" x 2" wood strips, metal hat-shaped channels, resilient metal channels or plaster lath strips. Anchorage of furring shall be to structural members, studs, joists or rafters by suitable nails, screws or other devices as described in the General Notes.

Lath may be gypsum lath, 16" x 48", or expanded metal or ribbed metal.

As an alternative to a conventional 3-coat plaster system, a veneer system of one or two veneer coats to a thickness of 1/16" to 1/8" may be used. Veneer plaster is applied to a specially prepared gypsum baseboard.

For spaces where high-moisture is expected, such as steam rooms or swimming pool enclosures, Keene's cement lime-sand plaster is recommended. Edges, corners, joints, and spaces around openings for electrical, plumbing and heating devices shall be properly sealed by materials with a life expectancy of not less than 20 years from the passage of dust particles.

Application shall also be in accordance with the General Notes.

5. Stucco and Metal Lath Applied Directly in Wall and Ceiling Surfaces

Where greater surface durability, water resistance, variety of texture or integral color is desired, stucco systems may be used in place of gypsum plaster. When used as a lead-based paint enclosure system, stucco – a wet mixture of Portland cement and lime – is trowel or spray applied to anchored expanded metal lath to produce a complete seal of wall or ceiling surfaces.

Stucco may also be used to enclose lead-based paint surfaces over expanded metal lath or over rigid foam board. The latter systems using polymer-based or polymer-modified plasters are spray or trowel applied to insulation board to which mesh reinforcement has been attached. These systems are known as Exterior Insulation Finish (EIF) and should be installed in accordance with recommendations of the Exterior Insulation Manufacturers Association (EIMA). In order to prevent lead-contaminated dust from leaving the surface and migrating through control joints a breathable wrap material such as Tyvek® may be required.

All stucco systems for interior or exterior lead-based paint enclosures shall provide control joints to prevent surface cracking. Other recommendations in General Notes shall also apply.

6. Stucco Applied to Metal Lath on Furring Strips

Stucco may be used to cover lead-based paint on interior walls and ceilings and exterior surfaces of many construction systems where the condition of the substrate requires furring strips for adequate anchorage of the lath.

Stucco, usually applied to lath in three coats – scratch, brown, and a finish coat – produces a highly water-resistant surface. Finish coats are available in a variety of textures and colors.

Lath for stucco is available in expanded metal, ribbed and self-furring lath. Accessories for control joints, reinforcing and corner beads are available.

Furring may be wood, 1" x 2" or 2" x 2" strips or metal hat-shaped channels. Rigid foam board for EIF systems may also be used.

Recommendations included in General Notes should be followed for stucco systems.

7. Plywood Paneling Applied Directly to Existing Wall and Ceiling Surfaces

Prefinished plywood panels or panels to be finished after installation, usually 1/4" thick, may be installed to walls and possibly to ceiling surfaces where the condition of the surface is suitable for application using annular-ringed nails and construction adhesive.

Care must be exercised in sealing all joints and edges to prevent passage of lead-containing dust particles. Non-hardening sealants such as silicone or urethane having a minimum 20 year life expectancy must be used for this purpose.

Lead-painted exterior surfaces may be enclosed with plywood panels such as Texture 1-11 or other plywood sheets, usually 5/8" to 3/4" thick. Application of these panels directly to existing surfaces requires anchorage to structural members using suitable nails or a combination of nails and construction adhesive. Passage of lead-containing dust must be prevented by sealing all edges and joints by suitable sealants and where necessary a surface wrap with a breathable cloth such as Tyvek®.

Additional recommendations listed under General Notes should also be followed.

8. Plywood Paneling Applied Over Furring Strips

Where plywood is used to enclose lead-based painted surfaces, which are unsuitable for direct attachment of plywood, furring strips, shimmed as required, may be used to provide a sound, level base to which plywood may be secured.

Wood furring, usually 1" x 2" or 2" x 2" strips, 16" to 24" on center is securely anchored using nails or screws to existing structural members or by means of masonry anchors, nails or toggle bolts to brick or masonry block walls.

All edges and corners of plywood panels must be sealed and surfaces wrapped where required to prevent dust migration. Other appropriate recommendations listed under General Notes must also be followed.

9. Solid Board Paneling Applied Directly to Wall or Ceiling Surfaces

Solid board paneling may be used to enclose lead-based painted interior wall and ceiling surfaces and exterior wall surfaces by application directly to suitable substrates.

Interior paneling may be unfinished or prefinished softwoods such as cedar, cypress, redwood, fir, and pine and hardwoods such as oak, elm, ash, fruitwoods, maple and walnut.

Exterior woods are usually the more insect-resistant woods such as cedar, cypress and redwood.

Most solid wood paneling is finished with tongue and groove or ship lapped edges for horizontal or vertical application or with interlocking edges, tapered for horizontal application. Some particle board material for horizontal application is also manufactured. Wood shingles, usually cedar, may also be used for exterior enclosure. Anchoring devices may be suitable nails or staples often used with a construction adhesive.

For most systems a breathable cloth wrap, such as Tyvek® is recommended as are other General Note suggestions.

10. Solid Board Paneling Applied Over Furring Strips

Where the condition of the surface to be enclosed lacks stability or evenness, the solid board paneling materials, minimum thickness of 5/8", as described in Section 9 above, may be installed over furring strips shimmed to produce an even, stable surface.

Furring may be wood 1" x 2" or 2" x 2" strips applied horizontally to accommodate vertical paneling or vertically to accommodate horizontal paneling. A wrap of the lead-based painted surface is usually required prior to installing furring. A breathable plastic cloth such as Tyvek® is used as wrap material to prevent lead-contaminated dust particles from migrating. Application shall also be in accordance with the General Notes.

11. Extruded or Shaped Sheet Metal over Existing Trim

In some construction situations, door and window frames and trim containing lead-based paint may be enclosed by the use of extruded vinyl shapes more cost effectively than removal and replacement of the in-place trim. Enclosure of the existing trim surfaces must completely seal all edges, corners and joints of the new trim covers with sealants such as silicone or urethane having a life expectancy of at least 20 years. Attachment may be accomplished by suitable nails, screws or clips and construction adhesive.

12. Ceramic Tile Applied in "Thin-Set" Mastic Directly to Existing Surfaces

Where condition of existing walls or floors allows, ceramic tile may be applied by "thin-set" method to surfaces containing lead-based paint to be enclosed. Tile should be pressed into a full-covering layer of mastic and allowed to set before applying grout to all surface joints. Sufficient grout shall be used to fill all spaces around and between tiles.

13. Ceramic Tile Applied in Mud Coat to Lath Directly to Existing Surfaces

Where it is desired to set ceramic tile in a mud coat, expanded metal lath or cement board lath is applied to existing lead-based painted surfaces. Tile is then set in a mud coat to the lath, allowed to set and then grouted with full joint grout. General Notes requirements also apply.

14. Ceramic Tile Applied in "Thin-Set" Mastic over Furring

Where the surface of existing lead-based painted walls requires furring to achieve a sound, level support for application of ceramic tile, a cement board panel may be anchored to wood strip, metal channel or cement board strips shimmed as required. Ceramic tile is then set in mastic on the furred cement board base. After the mastic has set up, all edges and joints between the tiles are grouted with grout forming a full joint in all voids. General Notes requirements also apply.

15. Ceramic Tile Applied in "Mud Coat" Over Furring

Ceramic tile to be used for enclosing lead-based painted surfaces may require a "mud coat" setting bed on a furred base. This may be especially true of the less precise hand-formed floor tile which requires a thicker setting bed permitting adjustments to produce an even floor.

On walls, metal lath or cement board lath may be attached to furring as a base for mud-coat setting bed. Furring should be shimmed as required to produce a level base for tile.

On floors, cement board, furred or shimmed as required to produce a true and level surface, is a suitable base for a "mud coat" application. General Note requirements apply.

After the tile has set, joints are grouted with suitable joint materials. Ceramic tile on floors requires a sand-mixed grout to produce a strong joint.

16. Brick Veneer Used to Enclose Lead-Based Painted Surfaces

A single width of brick may be applied as a brick veneer to enclose lead-based painted surfaces on both interior and exterior surfaces.

The first course of brick must be provided with the adequate structural support of a beam or steel shelf angle designed and attached to carry the load of the brick veneer wall without excessive deflection. The brick shall be laid in full beds or mortar, with full head joints attached to existing walls by suitable galvanized or stainless anchors imbedded in masonry joints, 24" on center, vertically and horizontally. All joints shall be tooled to produce a dense mortar joint.

At returns to frames, jambs, heads and sills of window and door openings, provision shall be made to seal existing surfaces from dust migration. A wrap cloth of breathable material such as Tyvek® may be required on exterior walls, especially where weep holes are provided to control moisture which has penetrated brick surfaces.

All building code room size and area requirements and exterior set-back restrictions must not be violated by the addition of the brick veneer.

17. Masonry Block Veneers Used to Enclose Lead-Based Painted Walls

A nominal 4" concrete masonry veneer may be applied to enclose lead-based painted surfaces on both interior and exterior wall surfaces.

All requirements listed above for brick veneer including structural support, anchorage to existing structure, treatment of joints and sealing of voids and joints shall also apply as shall requirements of codes and zoning.

18. Underlayment Grade Plywood, Oriented Strand Board or Particle Board Applied Over Existing Flooring

Underlayment grade plywood, oriented strand board or particle board, nominal thickness of 1/4" may be used to enclose lead-based painted wood floors. The underlayment should be applied just prior to the finish material and should be protected from damage its surface. Panel end joints should be staggered with respect to each other, and all joints should be offset with respect to joints in the subfloor. Panel edges and ends should be butted to a close but not tight fit (1/32" space). Panels should be nailed 6" along edges and 8" on center each way throughout the remainder with 3d annular-ringed nails or 16 gauge staples, 3" on center along edges and 6" on center throughout. End joints shall be filled and thoroughly sanded.

Underlayment is suitable as a base for resilient tile such as rubber, vinyl and cork, sheet flooring and carpeting usually with a pad. It may also be used as a base for think, mastic-set strip or parquet wood finish systems.

19. Vinyl Siding

Prefinished vinyl siding, having a life expectancy of at least 20 years, may be installed over a variety of existing exterior wall surfaces to enclose lead-based paint. Installation of a building wrap system using breathable cloth such as Tyvek® and sealing all joints with silicone or urethane sealers should be used to ensure that dust particles cannot migrate through the vinyl siding system.

All siding panels, components and trim shall be installed in accordance with manufacturer's recommendations using appropriate fastening devices for proper anchorage.

20. Aluminum Siding

Prefinished aluminum siding, having a life expectancy of at least 20 years, may be installed over a variety of existing exterior wall surfaces to enclose lead-based painted surfaces. Siding installation application recommendations are similar to those for vinyl siding in Section 19 above.

Anchorage of all siding panels, trim and components for aluminum siding shall employ the use of aluminum nails. All siding panels, components and trim shall be installed in accordance with manufacturer's recommendations using appropriate fastening devices for proper anchorage.

Appendix 7.3:

Generic Lead-Based Paint Specifications

Guide specifications, designed to be tailored to project and site conditions, are available from several sources, including the U.S. Department of Defense specifications listed below.

1. U.S. Department of Defense

The Unified Facilities Guide Specifications (UFGS) were developed by the Department of Defense for various construction activities. Because all specifications are project- and site-specific, the provisions of these generic specifications for lead-based paint activities in residential housing must be adapted to your specific project. In April 2006, the Unified Facilities Guide Specifications (UFGS) recodified the various guide specifications for the US Army Corps of Engineers (USACE), US Naval Facilities Command (NAVFAC), US Air Force Civil Engineering Support Agency (AFCESA), and National Aeronautics and Space Agency (NASA). Some of the new UFGS Section numbers, titles, and web addresses for lead-based paint related activities are:

Lead Based Paint Hazard Abatement, Target Housing & Child Occupied Facilities

(UFGS-02 83 19.00 10; formerly Section 13281A)

<http://www.wbdg.org/ccb/DOD/UFGS/UFGS%2002%2083%2019.00%2010.pdf>

Safety and Occupational Health Requirements

(UFGS-01 35 29; formerly Section 01525)

<http://www.wbdg.org/ccb/DOD/UFGS/UFGS%2001%2035%2029.13.pdf>

Removal/Control and Disposal of Paint with Lead

(UFGS-02 82 33.13 20; formerly Section 13283N)

<http://www.wbdg.org/ccb/DOD/UFGS/UFGS%2002%2082%2033.13%2020.pdf>

Lead in Construction

(UFGS-02 83 13.00 20; formerly Section 13282N)

<http://www.wbdg.org/ccb/DOD/UFGS/UFGS%2002%2083%2013.00%2020.pdf>

[All links accessed 7/27/2012; the sites may be moved or deleted later.]

Appendix 7.4:

Guidance on Specifications for Interim Control of Soil Lead Hazards¹

Guidance on suggested language that may be helpful in drafting specifications for methods and products used in interim controls of soil lead hazards is provided below, as mentioned in Chapter 11, section VI.E. This language should be adapted as needed to fit each particular site and each plan or design. Landscape contractors may be unfamiliar with the issue of lead in soil. Their standard practices may not be in line with lead-safe treatment methods. It is advisable to work closely with contractors on their first few lead-safe jobs to ensure that they are clear on how to properly implement interim controls. If abatement of soil lead hazards is planned, specifications should be written by a person certified in accordance with regulations of EPA or an EPA-authorized state or tribe.

1. Methods

Edging. Edge with any application of bark mulch, pea gravel, crushed stone, or concrete pavers. Edging type and location should be specified on drawings.

Fencing. Where noted on plans, new stockade fencing shall be spruce stockade fencing or equivalent, 6-8 feet high. Chain link fencing shall be 4 feet high when running adjacent to a driveway and 6 feet high around the remainder of the yard. Height changes are noted on plans. Posts for any type of fence shall be leveled and anchored in a concrete footing at the frost line (4' below grade).

Finish Grading. Do finish grading in conjunction with all surface alteration methods, including grass seeding, sod, mulch, asphalt paving, crushed stone, or pea gravel. Unless drawings show otherwise, spread topsoil on all lawn and planting beds to a 6" minimum (settled) depth and 1/2" below adjacent paved surfaces. Provide positive drainage away from buildings at a slope of not less than 2% (that is, when going a horizontal distance away from the building for some distance, the ground drops by 2% of that distance, for example, a 2½ inch drop over a 10 foot distance). Rototill areas where specified with lead free soil to reduce lead concentration. Add soil as necessary to bring to minimum depth and proper elevation.

Grass Seeding. Prepare seed bed with lime and fertilizer at specified rates. Seed at specified rate and rake lightly. Water thoroughly. Successful growth must be achieved in order to establish the seeded lawn. The owner or other responsible party will monitor and determine when seeded lawns have "taken". Reseed any wash outs or sparse areas larger than one square foot that appear up to the second mowing.

Grass Sodding. Remove old turf and safely discard off site. Remove remaining rocks or debris. If soil is dry, dampen with spray from a garden hose to keep dust down. Establish a rough grade by safely removing leaded soil or add enough lead free soil to bring the soil surface to the height and slope

¹ This specification is adapted from one in general use. It is believed not to be copyrighted; if it is, the copyright owner should contact the HUD Office of Healthy Homes and Lead Hazard Control at Lead.Regulations@HUD.gov.

necessary for proper drainage. Prepare the soil by tilling to a depth of approximately 8 inches. Add 3" lead free soil (or more if required) to bring down the lead level to less than 1,000 parts per million (ppm). Add amendments (including phosphate) and fertilizer according to sod company recommendations. Work in lead free soil, amendments, and fertilizer. Rake, level, and smooth with a roller. Water soil thoroughly 12 to 24 hours before laying sod. String a line and begin laying sod on either side of line. Place each roll tightly against the previous strip. Do not stretch, overlap, or leave voids. Joints in the sod should be staggered. Cut sod around sprinkler heads, trees, and curves. Roll to press roots against soil. Immediately after installation, water thoroughly. Keep the finished lawn moist until the sod knits with the soil beneath.

Lattice. Barricade all exposed soil under a porch or deck using (alkaline copper quaternary) ACQ pressure-treated wood framing, lattice, and pine trim. Prep, prime and paint pine trim or apply two coats of wood sealant. Install framed access door of like material. Include galvanized steel hasps and hinges.

Mulching. Cover bare soil with a water permeable landscape fabric. Apply to a settled depth of 3" in planting beds or 4" in play areas, unless specified otherwise.

Pea Gravel/Crushed Stone. Parking areas are to have a 6"–8" compacted crushed stone base followed by a 1 1/2" to 2" top cover of 3/8"–1/2" crushed stone. Maintain a minimum of 2% pitch across the surface to ensure positive drainage.

In dripline areas, sandwich landscape fabric between a 3"–4" settled depth of clean pea gravel (type should be indicated on plan) and the compacted subgrade. Spread the stone evenly over the landscape fabric. Slope the subgrade away from the foundation (1% minimum, 3% maximum).

In pathway areas, install landscape fabric under a 3"–4" settled depth of 3/8" crushed stone. Spread the stone evenly over the compacted subgrade and fabric. Use edge restraints to contain the stone.

Raised Beds/Planters/Sand Boxes. These products require some carpentry skills. All wood for raised beds, planters and sand boxes must be ACQ pressure-treated wood, sized according to plans and details. All wood should be secured with hot dipped galvanized steel spikes as per drawings. All raised beds, planters, and sand boxes must be lined with water permeable filter fabric. Raised beds and planters shall be filled with clean topsoil only, to the minimum depth specified on the drawings. Sand boxes shall be filled with "play" sand only, to the minimum depth specified on the drawings. If plantings are to be placed in the raised bed, install 4" of rich soil and 2" of mulch over a filter fabric weed barrier. If no plantings are planned, as in the drip zone near the foundation wall, install 3" of soil and 3" of crushed stone over a filter fabric weed barrier (EPA, 2001a).

Additional specifications for consideration by the designer: Joints and corners of the frame should be mechanically fastened with 3" galvanized wood screws to a 1" square stake driven into the ground to a minimum of 12". Corners of the box should be braced with triangular exterior grade plywood mechanically fastened directly to the wood frame with 3" galvanized wood screws

Tilling. For soil with high lead concentrations (noted on plans), wet the existing soil and till it with additional lead free soil to reduce the concentration of lead. Rototill soil to an 8"–10" depth and add phosphate, lime, and other amendments as necessary. Tilling should be done in conjunction with other surface alteration methods.

Tree and Shrub Planting. Set plants to match finished grade or slightly higher after settling. Provide lead free topsoil backfill for new plantings. Settle backfill thoroughly in planting holes by watering, firming, and tamping. Form saucers to retain water by placing ridges of soil around each plant.

Thoroughly water all plants at time of installation and as many times thereafter as conditions warrant to sustain healthy growing conditions. Saturate the soil around each plant thoroughly at each watering. Remove dead or unacceptable plant materials immediately. Cover beds with landscape fabric and top

with 3 to 4 inches (settled depth) of bark mulch. *Guarantee: Plant materials are to be guaranteed to remain in healthy condition for one year. All dead or unsatisfactory plants shall be replaced and replanted by the contractor free of charge. Make any replacements as soon as the planting season permits.*

Asphalt Paving/Concrete Pavers. (Note: This is considered an abatement method but is included here for completeness.) Paving shall be either asphalt or concrete pavers. The location and type of paving should be indicated on the landscape plan.

When using asphalt, excavate areas to be paved and remove excess material. Apply 4"–6" of crushed aggregate to excavated areas and grade to achieve proper pitch for water control. Fine grade and power roll for maximum compaction. Apply 2" of asphalt binder course to newly graded areas and power roll application for maximum compaction. Apply 1 1/2" of asphalt finish course to new binder then power roll entire area for maximum compaction. Emulsify and sand all joints upon completion for proper adhesion. Final grade is to have a minimum pitch of 2% across the surface to ensure that water will not puddle or flow toward the foundation.

For concrete pavers, the subgrade shall consist of a 4" compacted gravel sub base covered by landscape fabric and a 2" setting bed of crushed stone screenings. Install the pavers "hand tight" to achieve uniform joints of approximately 1/8" between pavers. Sweep joints with stone dust. Use edge restraints to prevent lateral creep by sand and pavers. Edge restraints may be plastic, steel, or concrete.

2. Products and Materials

A notice regarding products and materials should be included in a specification in order to ensure that a quality product is received. There is a wide range of quality among landscape materials.

All new soils and other materials incorporated into the work should meet local standards for lead, oil, and other substances. New materials include but are not limited to play sand, topsoil, fills, gravel, wood, safety surfacing, bark mulch, etc. Reserve the right at any time to test for lead and other hazardous substances (such as arsenic and cadmium). Levels of contamination should not exceed acceptable limits for exposure for the different soil categories as outlined by EPA or state regulatory authorities. If levels are found to be unacceptable through testing, the contractor should completely excavate, remove, and dispose of said materials off-site in a safe and legal manner and replace with clean materials at his/her own expense. All related work necessary to restore disturbed areas shall also be at the contractor's expense. This provision should apply to all new soils and other materials trucked to the site from other sources. A sample products and materials list is shown below.

Asphalt. Asphalt shall be comprised of crushed aggregate, asphalt binder, and asphalt finish.

Bark mulch. Bark mulch shall be tree bark from pine, hemlock or equivalent, aged a minimum of 6 months and no more than 18 months. The bark shall be shredded so that the resulting pieces are no more than 1/4" thick and no longer than 2". The mulch shall be free of stringy material and shall not contain an excess of fine particles. The mulch shall be deep brown in color, free of leaves, twigs, sod, weeds, shavings, and other foreign materials injurious to healthy plant growth.

Concrete pavers. Pavers shall be 2" thick concrete pavers. Pavers are available in various sizes (12" x 12", 6" x 9", 6" x 6", etc.), colors and shapes. Plan should specify color, shape, and size.

Edging. The edge restraints used shall be of three types: 1) the rolled plastic type; 2) 1" x 4" ACQ (Alkaline Copper Quaternary) pressure-treated wood furring strips anchored with 18' long stakes secured to the edging with 1 1/4" galvanized exterior wood screws; or 3) a paving edge restraint system installed per manufacturer's specifications.

Fertilizer. Fertilizer shall be complete fertilizer in granular form with 10-20-10 analysis. Apply to grass seeded areas at a rate of 2.5 – 5 pounds per 1000 square feet.

Gravel. Gravel shall be 3/4" crushed stone.

Landscape fabric. Landscape fabric shall be water permeable.

Landscape timbers. Landscape timbers shall be 6" x 6" x 8' or 6" x 8" x 8' pressure-treated ACQ timbers to retention 40/CCA guarantee for 40 years.

Lawn seed. Lawn seed shall be a triplex general or equivalent Kentucky bluegrass, chewings fescue, perennial rye grass mix. Apply at a rate of 5 pounds per 1000 square feet.

Lime. Lime shall consist of dolomitic limestones in granular form. Apply at a rate of 25 pounds per 1000 square feet.

Concrete pavers. Pavers shall be 12" x 12" concrete pavers or equivalent, in brick or tan as per Section I, Paving.

Pea gravel. Pea gravel shall be a combination of salmon, buff, and off white in color and between 3/4" and 3/8" in size. Gravel shall be free of loam, clay, vegetable matter, and elongated pieces of rock.

Plant materials. All plant material shall conform to the current issue of the American Standard for Nursery Stock (as of 2012, this was ANSI Z60.1–2004), published by the American Nursery & Landscape Association (www.anla.org). All plant materials shall be balled and burlapped, container grown, or nursery grown in areas with climatic conditions similar to those in the project area. Consult local garden center or nursery to develop a list of readily available and appropriate plant materials for your area. Include this plant list as part of the specification.

Sod. Sod shall be improved varieties Kentucky bluegrass, red fescue mix. Sod shall be harvested, delivered and installed within 24 hours. Keep cool and moist.

Soil additives. Additives shall consist of rock phosphate 0-4-0 or equivalent at a rate of 2 pounds per 100 square feet, and organic composted cow manure 1-1-1 or equivalent, at a rate of two 40 pounds bags per 100 square feet.

Topsoil (loam). The material to be furnished shall consist of screened loose, friable, fine sandy loam, or sandy loam, and should be free of subsoil, refuse, stumps, roots, rocks, cobbles, stones, brush, noxious weeds, litter, and other materials which are larger than 1" in any dimension. Organic matter shall constitute at least 5 percent and no more than 20 percent of the loam as determined by loss-on-ignition of oven dried samples (unless otherwise specified). The loam's pH range shall be 5.5 to 7.6. All new topsoil shall not exceed 200 ppm for lead.

References

ANSI Z60.1-2004. *American Standard for Nursery Stock*. American Nursery & Landscape Association, Washington, DC. 2004. ISBN 1-890148-06-7. Approved by the American National Standards Institute (<http://www.ansi.org>). <http://www.anla.org/docs/About%20ANLA/Industry%20Resources/ANLAStandard2004.pdf>

EPA, 2001a. U.S. Environmental Protection Agency, *Lead safe Yards: Developing and Implementing a Monitoring, Assessment, and Outreach Program for Your Community*, EPA. National Risk Management Laboratory, Office of Research and Development, Cincinnati, Ohio, January 2001 (EPA/625/R-00/012). <http://www.epa.gov/region1/leadsafe/tool2.html>

Appendix 8.1: Example of a Pre-Rehabilitation Risk Assessment and Limited Paint Testing Report for a Single-Family Dwelling Operated By a Small-Scale Owner

A sample report is attached to demonstrate the various components that should be included in a report.

The original source of this document is "Making it Work: Implementing the Lead Safe Housing Rule in CPD-funded Programs" at http://www.hud.gov/offices/lead/training/training_curricula.cfm, (accessed 7/27/2012) with revisions as appropriate.

Pre-Rehabilitation Lead Hazard Risk Assessment & Limited Lead-Based Paint Testing Report



PERFORMED AT:

Private Residence (William Jones, Occupant)
123 Olympic Street
Coolsville, Anystate 12347-5432

PREPARED FOR:

Mr. Bruce Smith
City of Coolsville
25 Glory Road
Coolsville, Anystate 12344-1111
555-555-0022

PREPARED BY:

ABC Environmental
State Certification #AN00-1234
Susan McGee, AN00-011110
Massachusetts Street Suite #2
Coolsville, Anystate 12346-2868
TEL: 555-555-0020
FAX: 555-555-0021
Project No.: ABC98765

Table of Contents

Executive Summary..... APP 8.1–4

Identifying Information and Purpose of Risk AssessmentAPP 8.1–5

Identified Lead HazardsAPP 8.1–5

Ongoing MonitoringAPP 8.1–6

Disclosure Regulations..... APP 8.1–7

Future Remodeling Precautions..... APP 8.1–7

Conditions & Limitations APP 8.1–7

Site Information and Field Testing APP 8.1–9

Resident Questionnaire APP 8.1–9

Building Conditions SurveyAPP 8.1–10

Paint Condition Survey APP 8.1–10

Paint Sampling and Testing APP 8.1–11

Interior Dust Sampling..... APP 8.1–11

Soil Sampling and Laboratory Information APP 8.1–12

Lead Hazard Control Options and Cost Estimates APP 8.1–13

Appendix A XRF Lead–Based Paint Testing Results APP 8.1–17

Appendix B Dust Wipe Sample Analytical Data APP 8.1–20

Appendix C Soil Sample Analytical Data..... APP 8.1–22

Appendix D Site and Floor Plan..... APP 8.1–24

Appendix E Scope of Renovation Work, As Provided to Assessor..... APP 8.1–24

Appendix F Copy of Risk Assessor’s License/Certification APP 8.1–24

Appendix G Copy of Firm’s Lead Activity License/Certification..... APP 8.1–24

Appendix H Copy of XRF Training Certificate
and LPA–1 Performance Characteristics Sheet..... APP 8.1–24

Appendix I “LEAD SPEAK” – A Brief Glossary APP 8.1–25

Appendix J Additional Lead and Lead Safety Resource Data APP 8.1–28

**Environmental Consultant:
ABC Environmental**

SIGNATURE OF RISK ASSESSOR _____
Name
Date

Executive Summary

As a result of the Lead Hazard Risk Assessment and the limited Lead-Based Paint Testing (Assessment) conducted on 2/14/2012, it was found that lead-based surface coatings (paint) and lead hazards were present on the subject property as of the date of the Assessment. The analytical results from this Assessment effort identified the following lead-based paint (LBP) and Lead hazards, as defined by EPA and/or HUD standards:

LBP

- ◆ Paint on All painted Exterior Components of the house, including the front porch

Existing Lead-Based Paint Hazards and Potential Lead Hazards

The following areas are coated with Lead-Based Paint (LBP) that is *deteriorated* and currently present existing lead-based paint hazards. All component substrates are wood.

- ◆ All exterior windows (windows are in fair condition)
- ◆ Roof fascia of house
- ◆ SW Bedroom door and door casing

A dust hazard was identified on the bathroom floor.

No soil lead hazards were identified.

The following areas are coated with LBP that is *intact* and that do not currently present lead hazards. However, the upcoming renovation plans include work inside the house and scraping and repainting the exterior. If these renovations occur, lead-safe work practices will need to be implemented during the project to ensure that lead hazards are not created.

- ◆ LBP on the exterior siding
- ◆ Front door and casing
- ◆ All exterior roof fascia and trim
 - LBP on all front porch components (floor, columns, frame, railing, door)
 - Bathroom wall
 - Kitchen wall

The planned renovation includes disturbance of the following components that do not contain lead-based paint:

- ◆ Floors that were tested throughout the house
- ◆ Interior doors that were tested (except SW Bedroom)
- ◆ Interior walls in bedrooms and living room

Please remember that all identified LBP and Lead Hazards should always be properly addressed by professionally trained, experienced, and/or licensed lead workers.

Following is a report of the information collected during this Assessment:

Identifying Information and Purpose of Risk Assessment

A Lead Hazard Risk Assessment and Limited LBP Testing (Assessment) was conducted at 123 Olympic Street, in Coolsville, Anystate for Mr. Bruce Smith on 2/14/2012. The Assessment was conducted for ABC Environmental, Coolsville, Anystate 12346-2868, Anystate State Certification #AN00-1234, by Susan McGee, a Certified Risk Assessor (Anystate License # AN00-011110). The purpose of the Assessment was to identify the presence of lead hazards on and/or in a limited number of surfaces inside and outside the residence, as well as to identify the presence of deteriorated lead-based paint (LBP) and LBP that may be disturbed during planned renovations. The City of Coolsville is providing funds from the U.S. Department of Housing and Urban Development to perform a remodeling project at this home. This Assessment was also completed to help the City and the homeowner determine if any of the upcoming HUD-funded renovation activities have the potential to create additional lead hazards. Based upon conversations with the Owner and the City of Coolsville Housing Agency (Client), to the knowledge of this Assessor, there has not been any previous LBP testing at this home.

As part of the Assessment, a visual survey of the property and structure was conducted, dust wipe sampling was performed on a limited number of interior surfaces, and composite soil samples were collected. In addition, limited on-site paint testing using an x-ray fluorescence (XRF) lead-in-paint analyzer was performed.

The Assessment was contracted for by Mr. Bruce Smith, City of Coolsville, Coolsville, Anystate 12344, (555) 555-0022. Further information concerning this project can be obtained from this contracting agency. The results of the limited assessment are summarized below.

Identified Lead Hazards

While the building and its paint was generally in good condition during the Assessment, the XRF results from the deteriorated paint that was tested showed that LBP hazards exist, as defined in the Residential LBP Hazard Reduction Act of 1992 (Title X) and as defined by the Environmental Protection Agency (EPA) regulation published in the January 5, 2001 Federal Register. The XRF results indicate that lead levels above EPA and/or US Department of Housing and Urban Development (HUD) criteria exist in the following locations:

Existing Lead Hazards

The following areas are coated with Lead-Based Paint (LBP) that is *deteriorated* and currently present existing lead-based paint hazards. All component substrates are wood.

1. All exterior windows (windows are in fair condition)
2. Roof fascia of house
3. SW Bedroom door and casing

Potential Lead Hazards

1. LBP is present on the exterior siding
2. LBP is present on the front door and casing

3. LBP is present on all exterior roof fascia and trim.
4. LBP is present on all front porch components.
5. LBP is present on bathroom and kitchen walls

A listing of environmental sampling locations and their associated lead contamination levels can be found in the sections addressing the analytical laboratory results for paint, dust, and soil.

Hazard control options and associated cost estimates for the areas or components identified with LBP or lead hazards are also discussed later in this report. In an effort to aid in the interpretation of the listed findings a glossary of terms and a list of publications and resources addressing lead hazards and their health effects are included at the end of this report.

Ongoing Monitoring

Ongoing monitoring is necessary in all dwellings in which LBP is known or presumed to be present. At these dwellings, the very real potential exists for LBP hazards to develop. Hazards can develop by means such as, but not limited to: the failure of lead hazard control measures; previously intact LBP becoming deteriorated; dangerous levels of lead-in-dust (dust lead) re-accumulating through friction, impact, and deterioration of paint; or, through the introduction of contaminated exterior dust and soil into the interior of the structure. Ongoing monitoring typically includes two different activities: re-evaluation and annual visual assessments. A re-evaluation is a risk assessment that includes limited soil and dust sampling and a visual evaluation of paint films and any existing lead hazard controls. Re-evaluations are supplemented with visual assessments by the Client, which should be conducted at least once a year, when the Client or its management agent (if the housing is rented in the future) receives complaints from residents about deteriorated paint or other potential lead hazards, when the residence (or if, in the future, the house will have more than one dwelling unit, any unit that turns over or becomes vacant), or when significant damage occurs that could affect the integrity of hazard control treatments (e.g., flooding, vandalism, fire). The visual assessment should cover the dwelling unit (if, in the future, the housing will have more than one dwelling unit, each unit and each common area used by residents), exterior painted surfaces, and ground cover (if control of soil-lead hazards is required or recommended). Visual assessments should confirm that all Paint with known or suspected LBP is not deteriorating, that lead hazard control methods have not failed, and that structural problems do not threaten the integrity of any remaining known, presumed or suspected LBP.

The visual assessments do not replace the need for professional re-evaluations by a certified risk assessor. The re-evaluation should include:

1. A review of prior reports to determine where lead-based paint and lead-based paint hazards have been found, what controls were done, and when these findings and controls happened;
2. A visual assessment to identify deteriorated paint, failures of previous hazard controls, visible dust and debris, and bare soil;
3. Environmental testing for lead in dust, newly deteriorated paint, and newly bare soil; and
4. A report describing the findings of the reevaluation, including the location of any lead-based paint hazards, the location of any failures of previous hazard controls, and, as needed, acceptable options for the control of hazards, the repair of previous controls, and modification of monitoring and maintenance practices.

The first reevaluation should be conducted no later than two years after completion of hazard controls, or, if specific controls or treatments are not conducted, two years from the beginning of ongoing lead-based paint monitoring and maintenance activities. Subsequent reevaluations should be conducted at intervals of two years, plus or minus 60 days. If two consecutive reevaluations are conducted two years apart without finding a lead-based paint hazard, reevaluation may be discontinued.

Please refer to your community development agency, housing authority, or other applicable agency for additional local/regional regulations and guidelines governing re-evaluation activities.

Disclosure Regulations

A copy of this complete report must be made available to new lessees (tenants) and/or must be provided to purchasers of this property under Federal law before they become obligated under any future lease or sales contract transactions (Section 1018 of Title X – found in 24 CFR Part 35 and 40 CFR Part 745), until the demolition of this property. Landlords (Lessors) and/or sellers are also required to distribute an educational pamphlet developed by the EPA entitled *“Protect Your Family From Lead in Your Home”* and include standard warning language in their leases or sales contracts to ensure that parents have the information they need to protect their children from LBP hazards.

Future Remodeling Precautions

It should be noted that during this Assessment, a limited number of areas were tested for the presence of LBP. All LBP, dust, and soil hazards that were identified are addressed in this report. However, LBP, dust lead hazards, and/or soil lead hazards may be present at other locations of the property. Additional paint testing should precede any future remodeling activities that occur at any untested areas. Additional dust and/or soil sample collection and analysis should follow any hazard control activity, repair, remodeling, or renovation effort, and any other work efforts that may in any way disturb LBP and/or any lead containing materials. These Assessment activities will help the Client and owner to ensure the health and safety of the occupants and the neighborhood. Details concerning lead-safe work techniques and approved hazard control methods can be found in the HUD publication entitled: *“Guidelines for the Evaluation and Control of LBP Hazards in Housing”* (www.hud.gov/offices/lead). Remodeling, repair, renovation and painting at the residence beyond the scale of minor repair and maintenance activities must be conducted in accordance with the EPA’s Lead Repair, Renovation, and Painting Rule (within 40 CFR part 745); see the EPA’s website on the RRP Rule at <http://www.epa.gov/lead/pubs/renovation.htm> for the scope and requirements of that Rule. Lead-based paint abatement or lead-based paint hazard abatement at the residence must be conducted in accordance with the EPA’s Lead Abatement Rule (also within 40 CFR 745); see the EPA’s website for Lead Abatement Professionals at <http://www.epa.gov/lead/pubs/traincert.htm>.

Conditions & Limitations

Staff of ABC Environmental has performed the tasks listed above requested by the Client in a thorough and professional manner consistent with commonly accepted standard industry practices, using state of the art practices and best available known technology, as of the date of the assessment. ABC Environmental cannot guarantee and does not warrant that this Assessment/Limited LBP Testing has identified all adverse environmental factors and/or conditions affecting the subject property on the date of the Assessment. ABC Environmental cannot and will not warrant that the Assessment/Limited Testing that was requested by the

client will satisfy the dictates of, or provide a legal defense in connection with, any environmental laws or regulations. It is the responsibility of the client to know and abide by all applicable laws, regulations, and standards, including EPA's Renovation, Repair and Painting regulation.

The results reported and conclusions reached by ABC Environmental are solely for the benefit of the client. The results and opinions in this report, based solely upon the conditions found on the property as of the date of the Assessment, will be valid only as of the date of the Assessment. ABC Environmental assumes no obligation to advise the client of any changes in any real or potential lead hazards at this residence that may or may not be later brought to our attention. Further conditions and limitations to this contracted report are included in the general terms and conditions supplied to the client with the contract for services.

Site Information and Field Testing

Resident Questionnaire

A resident questionnaire was completed as part of the Assessment, to help the Client identify particular use patterns, which may be associated with potential LBP hazards, such as opening and closing windows painted with LBP. The answers to the questionnaire were obtained during an interview with the occupants, Mr. and Mrs. Homeowner. Following is a summary of the information obtained during that interview:

Children in the Household:	2 (Ages 1, 3); None visit frequently
Children's bedroom locations:	SW bedroom
Children's eating locations:	Kitchen
Primary interior play area(s):	Living Room
Primary exterior play area(s):	Back Yard; on and near play equipment
Toy Storage:	NA
Pets:	2 cats (indoor)
Children's blood lead testing history:	None
Observed chewed surfaces:	None
Women of child bearing age:	1
Previous lead testing:	None
Most frequently used entrances:	Front door
Most frequently opened windows:	Kitchen and Living Room
Structure cooling method:	Central Air Conditioning
Gardening – type and location(s):	Previous vegetable garden (in back yard)
Plans for landscaping:	None
Cleaning regiment:	Weekly
Cleaning methods:	Mopping, sweeping, dusting, vacuuming
Recently completed renovations:	None recent
Demolition debris on site:	None
Resident(s) with work lead exposure:	None
Planned renovations:	A preliminary Scope of Work document for this residence was supplied prior to the onset of the Assessment. A copy of that document is included in Appendix E of this report. The planned renovation is through the City of Coolsville program. A complete list of pending renovation activities can be obtained from Mr. Bruce Smith, City of Coolsville, Anystate.

Building Conditions Survey

Date of Construction:	1937
Apparent Building Use:	Residential
Setting:	Residential
Front Entry Faces:	East
Design:	Bungalow
Construction Type:	Wood framed, wood shingles
Lot Type:	Slight slope, drains to the east
Roof:	Fair (curled shingles), no apparent roof leaks
Foundation:	Good, no known basement leaks or visible foundation cracks
Front Lawn Condition:	Approx. 10% bare soil
Back Lawn Condition:	Aprox. 20% bare soil; existence of play structure
Drip Line Condition:	Some Paint chips along the driplines
Site Evaluation:	Very good
Exterior Structural Condition:	Exterior structural is good and paint condition is fair
Interior Structural Condition:	Excellent
Overall Building/Site Condition:	Very Good

Paint Condition Survey

Please Note: EPA and HUD have provided a specific definition for the term “deteriorated paint.” Deteriorated paint is defined as “any interior or exterior paint or other coating that is peeling, chipping, chalking or cracking, or any paint or coating located on an interior or exterior surface or fixture that is otherwise damaged or separated from the substrate.” This definition is most typically associated with surface conditions only. Usage of this term in describing conditions other than those associated with surface coatings are not known to be defined by EPA or HUD.

Identified Deteriorated Paint, Paint Conditions, Lead Content, & Most Apparent Cause of Deterioration:

- ◆ Lead-based paint on the exterior windows, portions of porch and fascia are peeling over wood.
- ◆ Paint on one bathroom wall was deteriorated; that wall was painted with lead-based paint.
- ◆ Lead in dust on the bathroom floor was above the dust-lead standard.
- ◆ Moisture and age are the most likely causes of the damage.

The remaining paint exhibited no apparent signs of deterioration, as of the date of the Assessment.

Paint Sampling and Testing

Limited LBP Testing, conforming with HUD regulation 24 CFR 35.930(c), (d) was accomplished at this residence on surfaces found to have deteriorated paint and/or where it was indicated to the Assessor that planned renovation would occur. No paint chip samples were taken. On 2/14/2012, a total of 23 tests (assays) were taken at a limited number of specified surfaces on the inside and outside of the residence using an x-ray fluorescence analyzer. Deteriorated paint and areas that were specified to be disturbed during the planned renovation project were tested. Lead concentrations that meet or exceed the HUD published levels identified as being potentially dangerous (e. g., greater than or equal to 1.0 milligrams per centimeter square [$> 1.0 \text{ mg/cm}^2$]) were encountered on the exterior siding and trim, the exterior window components and trim, and all front porch components.

Some of the remaining test locations exhibited lead-in-paint levels below the HUD levels, but in great enough quantities to be detectable by our XRF analyzer. It should be noted that lead concentrations (in paint) that are less than the levels that identify a surface coating as LBP still have the potential of causing lead poisoning. Should these or any potential LBP painted components and/or surfaces be disturbed in any manner that generates dust, extreme care must be taken to limit its spread. **It should be presumed that any and all painted surfaces, components, or surfaces not requested to be tested as part of this investigation, or any previous investigations, are coated with LBP, and that renovation or repair activities in these areas dictate the use of safe work practices that limit dust generation and area contamination.**

Testing was performed by Susan McGee, a State of Anystate certified Risk Assessor, using the Weluvexraze X-ray Fluorescence analyzer (S/N 1234, State of Anystate license #AN99-4321). Please refer to the appendices for the detailed XRF, dust and soil sampling analytical reports.

Interior Dust Sampling

A total of 6 single surface dust wipe samples were collected in an effort to help to determine the levels of lead-containing dust on the interior window sills and floors. These samples were collected from areas most likely to be lead-contaminated if lead-in-dust is present. These samples were collected in accordance with the requirements of ASTM Standard E-1728, Standard Practice for Field Collection of Settled Dust Samples Using Wipe Sampling Methods for Lead Determination by Atomic Spectrometry Techniques. EPA, HUD and State of Anystate regulations define the following as hazardous levels for lead dust in residences: floors – $\geq 40 \text{ mg/ft}^2$ (micrograms per square foot); interior window sills – $\geq 250 \text{ mg/ft}^2$. There is no EPA dust-lead hazard standard for window troughs. Please refer to **Appendix B – Dust Wipe Analytical Results** for the laboratory reports and to **Appendix I – Lead and Lead Safety Information and Resources** for a list of publications and resources addressing lead hazards and their health effects; both are located at the end of this report. As indicated below, a hazardous level of leaded dust, as defined by EPA and HUD, was detected in one sample. **This sample was obtained from the bathroom floor and constitutes a dust-lead hazard in that room.**

	Type	Location	Component	Sample Size (ft ²)	Sample Location	Test Results (µg/ft ²)
1	Dust Wipe	Bathroom	Floor	1.00	Floor, Center of room.	80.0
2	Dust Wipe	Living Room	Sill	0.66	Wood, Wall A, sill.	41.1
3	Dust Wipe	Kitchen	Floor	1.00	Carpet, Center of room.	<20.0
4	Dust Wipe	Kitchen	Sill	0.50	Wood, Wall D, sill.	<40.0
5	Dust Wipe	Master Bedroom	Floor	1.00	Carpet, Center of room.	<20.0
6	Dust Wipe	Master Bedroom	Sill	0.74	Wood, Wall C, sill	<27.0

Laboratory Information:

Anytown Laboratories

2222 West Street
Anytown, Anystate 12347 (800) 555-0055

Dust Wipe Analysis Protocol:

EPA Method SW846, 7420, implementing a microwave-assisted digestion process.

Dust Wipe medium used:

Lead-Wipes, ASTM # E1792-96aqq

National Lead Laboratory Accreditation Program

Serial number:

#987654

Soil Sampling and Laboratory Information

Two (2) composite soil samples were collected at this residence in accordance with the requirements of ASTM Standard E-1727, Standard Practice for Field Collection of Soil Samples for Lead Determination by Atomic Spectrometry Techniques. A composite sample is a sample containing soil from a stated number of locations mixed together to form a Composite sample. The first sample consisted of soil from four locations in the front yard flower garden at 1’ on center (O.C.). The second sample was collected from four separate locations in the B (south) side yard at 1’ O.C. The samples were collected from bare soil areas only. The analytical results did not identify lead concentrations at or above the levels that EPA and HUD identifies as hazardous. See the following table for a summary of the soil sampling results. Please refer to **Appendix C – Soil Sample Analytical Data** for the detailed analytical reports. Testing data in **bold face** indicates soil lead levels at or above the EPA Hazardous Levels of Lead regulations that were published on January 5, 2001.

	Type	Location	Comments	Test Results (µg/g)
7	Composite	Front flower garden	Bare Soil sample	990
8	Composite	Backyard under play equipment – play area	Bare Soil sample	260

Laboratory Information:

Anytown Laboratories	2222 West Street Anytown, Anystate 12346 (800) 555-0055
Soil Analysis Protocol:	EPA Method SW846, 7420, implementing a microwave-assisted digestion process.
National Lead Laboratory Accreditation Program Serial number:	#987654

Lead Hazard Control Options and Cost Estimates

Lead-safe work practices and worker/occupant protection practices complying with current EPA, HUD and OSHA standards will be necessary to safely complete all work involving the disturbance of LBP coated surfaces and components. In addition, any work considered lead hazard control will enlist the use of interim control (temporary) methods and/or abatement (permanent) methods. It should be noted that all lead hazard control activities have the potential of creating additional hazards or hazards that were not present before.

Details for the listed lead hazard control options and issues surrounding occupant/worker protection practices can be found in the publication entitled: *Guidelines for the Evaluation and Control of LBP Hazards in Housing* published by HUD, the Environmental Protection Agency (EPA) lead-based paint regulations, and the Occupational Safety and Health Administration (OSHA) regulations found in its Lead in Construction Industry Standard.

The associated cost estimates, unless otherwise noted, include the labor and materials to accomplish the stated activity and most additional funds typically found to be necessary to complete worker protection, site containment, and cleanup procedures. These are approximate estimates only and due to a variety of potential factors, may not accurately reflect all local cost factors. A precise estimate must be obtained from a certified LBP abatement contractor or a contractor trained in lead-safe work practices. Properly trained and/or licensed persons, as well as properly licensed firms (as mandated) should accomplish all abatement/interim control activities conducted at this residence.

Interim controls, as defined by HUD, means a set of measures designed to temporarily reduce human exposure to LBP hazards and/or lead containing materials. These activities include, but are not limited to: component and/or substrate repairs; paint and varnish repairs; the removal of dust-lead hazards; renovation; remodeling; maintenance; temporary containment; placement of seed, sod or other forms of vegetation over bare soil areas; the placement of at least 6 inches of an appropriate mulch material over an impervious material, laid on top of bare soil areas; the tilling of bare soil areas; extensive and specialized cleaning; and, ongoing LBP maintenance activities.

Abatement, as defined by HUD, means any set of measures designed to permanently eliminate LBP and/or LBP hazards. The product manufacturer and/or contractor must warrant abatement methods to last a minimum of twenty (20) years, or these methods must have a design life of at least twenty (20) years. These activities include, but are not necessarily limited to: the removal of LBP from substrates and components; the replacement of components or fixtures with lead containing materials and/or lead containing paint; the permanent enclosure of LBP with construction materials; the encapsulation of LBP with approved products; the removal or permanent covering (concrete or asphalt) of soil-lead hazards; and, extensive and specialized cleaning activities. (EPA's definition is substantively the same.)

SPECIFICATION EXCERPTS:

All work shall be done in accordance with the EPA RRP Rule or the EPA Lead Abatement Rule, as applicable, or the corresponding EPA-authorized State or tribal program, based on the control strategy determined by the owner or owner’s representative. These rules incorporate the protocols in the HUD *Guidelines for the Evaluation and Control of LBP Hazards in Housing*.

All firms performing interim control or lead abatement activities must certified by the State of Anystate, which is authorized by EPA to conduct the certification programs. All persons performing interim control or lead abatement activities must have successfully completed a State of Anystate accredited training program in “renovation” (more specifically, renovation, repair and painting); or have successfully completed a State of Anystate accredited training program in lead abatement work or supervision and been certified by the State of Anystate, as applicable, except that, if the housing is not receiving federal housing or rehabilitation assistance, the workers need only on-the-job training from the certified renovator.

SPECIAL CLEANING PRECEDING LEAD HAZARD CONTROL ACTIVITIES

- a) Before any lead hazard control activities begin, the structure and site must be inspected and pre-cleaned. Some of the required steps include removing large debris and paint chips followed by HEPA vacuuming of all horizontal surfaces (floors, window sills, troughs, etc.). (The cleaning protocols described in this publication can assist the contractor in doing a preliminary cleaning and improving the chances of passing clearance inspections after remediation.)

Precleaning \$XX/S.F.

HAZARD 1: Deteriorated LBP on the exterior siding and trim

- a) INTERIM CONTROLS – STABILIZATION: A lead hazard could be created if the exterior siding is improperly prepared for repainting (scraped) during the upcoming renovations. Following preparation work, the lead-based paint coatings on the exterior siding and trim may be addressed by stabilizing the underlying substrate and then repainting. (This activity has the potential to create a high volume of lead-contaminated dust, and extra care must be taken by the contractor to limit and contain the dust generated.)

Stabilization \$XX/S.F.

- b) ABATEMENT – ENCLOSURE: Enclose all exterior siding and trim with vinyl siding and pre-finished aluminum wrap materials. Use caulk to seal the bottom of the siding to the house and prevent leaded dust from falling through to the ground. (This method usually generates smaller amounts of lead-contaminated dust than does scraping and repainting, and would permanently enclose the surfaces, eliminating future hazards. Even though the potential for leaded dust contamination is generally less with this method of remediation, special attention to work practices will be necessary to limit dust generation.)

Siding/Trim Enclosure \$XX/S.F.

HAZARD 2: Deteriorated LBP on all exterior window components and trim

- a) INTERIM CONTROLS – PAINT STABILIZATION: A lead hazard could be created if the exterior window components and trim is prepared for repainting (scraped) during the upcoming renovations. Following preparation work, the lead-based paint coatings on the exterior window components and trim may be addressed by stabilizing the surfaces with new paint. (This activity has the potential to create a high volume of lead-contaminated dust, and extra care must be taken by the contractor to limit and contain the dust generated.)

Stabilization \$XX/S.F.

- b) ABATEMENT – WINDOW REPLACEMENT: This involves removing the exterior window components and installing new replacement windows. All windows must be sealed off from the inside of the house during the duration of the work and extra care must be taken by the contractor to limit and contain the dust generated. (This activity has the potential to create a high volume of lead-contaminated dust.)

Removal of exterior window components
and installation of replacement windows. \$XXX/ea.

HAZARD 3: Deteriorated LBP on all painted front porch components (e.g., floor, columns, frame, door)

- a) INTERIM CONTROLS – PAINT STABILIZATION: Stabilize the underlying substrate and then repaint. (This activity has the potential to create a high volume of lead-contaminated dust, and extra care must be taken by the contractor to limit and contain the dust generated.)

Stabilization \$XXX/S.F.

- b) ABATEMENT – COMPONENT REPLACEMENT: Remove and replace all of the painted porch components (This remediation option has the potential to generate extremely high amounts of lead-contaminated dust and would require extensive containment.)

Replacement of all porch components \$XXX- \$XXX

HAZARD 4: Deteriorated paint on wall and floor dust-lead hazard in bathroom

- a) INTERIM CONTROLS – REMOVAL OF DUST LEAD HAZARD AND STABILIZATION: The existing dust on the bathroom floor must be removed prior to preparing the room for the paint stabilization work, in particular, before the plastic sheeting is laid on the floor. The deteriorated lead-based paint coating and the underlying bathroom wall substrates must be stabilized and then repainted. During the cleaning phase of the project, special care must be taken to ensure that the dust is removed from the floor. (This activity has the potential to create a high volume of lead-contaminated dust, and extra care must be taken by the contractor to limit and contain the dust generated.)

Stabilization of bathroom walls \$XXX/S.F.

- b) ABATEMENT – COMPONENT REPLACEMENT: Remove and replace of all bathroom walls components. The existing dust on the bathroom floor must be removed prior to preparing the room for the paint stabilization work, in particular, before the plastic sheeting is laid on the floor. During the cleaning phase of the project, special care must be taken to ensure that the dust is removed from the floor. (This remediation option has the potential to generate extremely high amounts of lead-contaminated dust and would require extensive containment. Abatement would normally not be the most feasible or cost-effective approach for this room, but remains an option.)

Replacement of painted components in bathroom \$XXXX

SPECIAL CLEANING FOLLOWING LEAD HAZARD CONTROL ACTIVITIES

As part of the end of all lead hazard control activities, the structure and site must be inspected and cleaned in accordance with either the EPA RRP Rule or the EPA Lead Abatement Rule, as applicable.

CLEARANCE FOLLOWING LEAD HAZARD CONTROL ACTIVITIES

Because this housing is receiving federal rehabilitation assistance, and the total amount of painted surfaces to be disturbed in the lead hazard control and rehabilitation work exceed HUD’s *de minimis* amounts, HUD requires a clearance examination following the rehabilitation. Because of this regulatory requirement, cleaning verification as described in EPA’s RRP rule is not allowable on this project and clearance must be performed.

Replacement of painted components in bathroom \$XXXX

Additional Notes:

Accumulation of debris is not permitted, and all plastic drop cloths must be cleaned, folded inward, tied, and disposed of properly each day. All trash must be promptly and properly removed from the site or stored securely prior to removal, and the area must be left clean and as close to original condition as possible, or better. Following the HUD Guidelines will help increase the chances of attaining State of Anystate lead-in-dust clearance levels.

Remember that lead testing occurred at a limited number of locations in the structure; so LBP, lead-based paint hazards (of paint, dust or soil) and/or other lead-containing materials could still be present in the unit at areas not tested as part of this Lead Hazard Risk Assessment. If, at a later date, any repair, maintenance, remodeling or renovation activities disturb any paint where the concentrations of lead are not known, procedures should be used that presume that paint is lead-based paint, or that paint should be tested to determine if it is lead-based paint.

Appendix A

XRF Lead-Based Paint Testing Results

Appendix A – XRF Analytical Sampling Results for 123 Olympic Street, Coolsville, Anystate 12347 2/14/2012									
Reading Number	Location ¹	Side	Structure	Feature	Condition	Substrate	Color	Result	Lead (mg/cm ²)
1	LR	A	Wall	Interior	Good	Drywall	White	NEG	0.5
2	Back Porch	D	Porch Door	Interior side	Good	Wood	White	NEG	0.6
3	Front Porch	A	Column	Exterior	Fair	Wood	Tan	POS	6.7
4	Front Porch	A	Railing		Fair	Wood	Tan	POS	6.7
5	Front Porch	A	Ceiling		Fair	Wood	Tan	POS	6.7
6	Front Porch	A	Wall		Fair	Wood	Tan	POS	6.7
7	Front Porch	A	Posts		Fair	Wood	Tan	POS	6.7
8	Front Porch	A	Stairs	Treads	Fair	Wood	Tan	POS	6.7
9	DR-exterior	A	Window	Sash	Fair	Wood	Tan	POS	11.8
10	Exterior	A	Window	Casing	Fair	Wood	Tan	POS	5.4
11	Exterior	D	Wall	Siding	Good	Wood	Green	POS	8.5
12	Exterior	B	Wall	Siding	Good	Wood	Green	POS	5.3
13	Front Porch	A	Floor		Good	Concrete	Gray	POS	2.6
14	Front Door	A	Exterior side	Door	Poor	Wood	White	POS	1.9
15	Front Door	A	Casing	Casing	Poor	Wood	White	POS	1.9
16	Bathroom	B	Wall		Fair	Drywall	Blue	POS	9.1
17	Bathroom	B	Wall	Baseboard	Good	Wood	Blue	NEG	0.1
18	Bathroom	B	Wall	Shoemolding	Good	Wood	Blue	NEG	0.1
19	Mstr Bdrm	Center	Floor		Good	Wood	Brown	NEG	0.3
20	Mstr Bdrm	Center	Wall		Good	Drywall	White	NEG	0.2

21	Mstr Bdrm	Center	Wall	Baseboard	Good	Wood	White	NEG	0.2
22	Mstr Bdrm	Center	Wall	Top Molding	Good	Wood	White	NEG	0.1
23	Mstr Bdrm	Center	Ceiling		Good	Drywall	White	NEG	0.1
24	Mstr Bdrm	B	Door		Good	Wood	White	NEG	0.1
25	SW Bdrm	A	Door		Good	Wood	White	POS	5.2
26	SW Bdrm	A	Door	Casing	Good	Wood	White	POS	9.5
27	SW Bdrm	B	Wall		Good	Drywall	Blue	NEG	0.8
28	SW Bdrm	B	Trim		Good	Wood	Blue	NEG	0.5
29	Kitchen	C	Exterior Door	Door - interior side	Good	Wood	White	NEG	0.3
30	Kitchen	D	Wall	Interior-next to refrig.	Good	Drywall	Yellow	POS	4.1
31	Back Prch	D	Wall	Interior	Good	Wood	White	NEG	0.7
32	Back Prch	B	Wall	Interior	Good	Drywall	White	NEG	0.3
33	Front Porch	A	Trim	Exterior SE corner	Good	Wood	Tan	POS	4.9
34	Exterior	A	Trim	Fascia-NE edge	Good	Wood	Tan	POS	4.7
35	Exterior	C	Wall	Siding	Good	Wood	Green	POS	2.8
36	DR		Floor		Good	Wood	Brown	NEG	0.3

¹ See Sketch in Appendix A

XRF Calibration Checks

C-1	Calibration Verify	NIST Lead Paint Film Standard, 1.0 + .1, (Red NIST Film)	1.0
C-2	Calibration Verify	NIST Lead Paint Film Standard, 1.0 + .1, (Red NIST Film)	1.1
C-3	Calibration Verify	NIST Lead Paint Film Standard, 1.0 + .1, (Red NIST Film)	0.9

Performed by ABC Environmental, 920 Massachusetts Avenue, Poolsville, Anystate 12346-2868

Appendix B
Dust Wipe Sample Analytical Data

ANYTOWN LABORATORIES

INCORPORATED
 2222 West Street
 Anytown, Anystate 12346 (555) 555-0055 · 800-555-0033 · (Fax) 555-555-0099
Excellence in Customer Service and Technology
 AIHA/ELLAP 100100, NVLAP 0000, CAELAP 1111, RRLAP 1010

LABORATORY ANALYSIS REPORT

Lead Analysis by EPA 3050B/7420 Method

CLIENT #:	ABC-123	DATE COLLECTED:	2/14/2012
CLIENT:	ABC Environmental	DATE RECEIVED:	2/15/2012
ADDRESS:	7941 Westgate Street	DATE ANALYZED:	2/15/2012
	Poolsville, Anystate 12346-2636	DATE REPORTED:	2/15/2012
PO #:	N/A	SAMPLE TYPE:	Wipe
PROJECT NAME:	City of Coolsville		
JOB LOCATION:	123 Olympic Street, Coolsville, Anystate 12347		

ALI Sample No	Client Sample No.	Sample Description	Sample Area (ft ²)	Dilution Factor	Total Lead (µg)*	Lead Concentration (µg/ft ²)
021559	1234-1	Bathroom floor-center	1.0	1	80.0	80.0
021560	1234-2	Living Rm Sill	.66	1	41.1	41.1
021561	1234-3	Kitchen Floor	1.00	1	<20.0	<20.0
021562	1234-4	Kitchen D Sill	1.00	1	<40.0	<40.0
021563	1234-5	Mstr Bdrm Floor	1.00	1	<20.0	<20.0
021564	1234-6	Mstr Bdrm Sill	0.74	1	<27.0	<27.0

QC – 18081	10.0 ppm Calibration Std				1,012.3	101.2%
QC – 18081	200 µg spike				210.7	105.4%
QC – 18081	5.0 ppm Calibration Std				521.7	104.4%
QC – 18081	Blank				<20.0	
QC – 18081	NIST 2710 Standard				569.7	103.0%

JUDITH JUNE

ANALYST: Judith June

Total No. of Pages in Report: 1

Matthew Monday, CIH

REVIEWED BY: Matthew Monday, CIH, Dept. Head

Minimum Reporting Limit: 20 µg Total Lead. Effective 3/6/01, EPA Lead Hazard Standards: 40 µg/ft² for floors and 250 µg/ft² for interior window sills, 400 µg/ft² for window troughs. Industrial projects may have limits established per project. *For true values, assume two (2) significant figures.

Appendix C

Soil Sample Analytical Data

ANYTOWN LABORATORIES INCORPORATED

2222 West Street
 Anytown, Anystate 12346 (555) 555-0055 · 800-555-0033 · (Fax) 555-555-0099
Excellence in Customer Service and Technology
 AIHA/ELLAP 100100, NVLAP 0000, CAELAP 1111, RRLAP 1010

LABORATORY ANALYSIS REPORT

Lead Analysis by EPA 3050B/7420 Method

CLIENT #:	ABC-123	DATE COLLECTED:	2/14/2012
CLIENT:	ABC Environmental	DATE RECEIVED:	2/15/2012
ADDRESS:	7941 Westgate Street	DATE ANALYZED:	2/15/2012
	Poolsville, Anystate 12346-2636	DATE REPORTED:	2/15/2012
PO #:	N/A	SAMPLE TYPE:	Soil

PROJECT NAME: City of Coolsville
 JOB LOCATION: 123 Olympic Street, Coolsville, Anystate 12347

ALI Sample No	Client Sample No.	Sample Description	Sample Wt (mg)	Dilution Factor	Total Lead (μg)*	Lead Concentration (% by wt)	Lead Conc (ppm)
021565	1234-S1	Front Flower Garden	1,580	1	990	.067	670
021566	1234-S2	Backyard-under play equipment	1,275	1	560	.045	450

QC – 14669	10.0 ppm Calibration Std		967.2	96.7%	
QC – 14669	200 μg spike		196.0	98.0%	
QC – 14669	5.0 ppm Calibration Std		503.8	100.8%	
QC – 14669	Blank		>20.0		
QC – 14669	NIST 2710 Standard		541.8	97.9%	

William W. Webster
 ANALYST: William Wilbur Webster
 Total No. of Pages in Report: 1

Matthew M. Monday, CIH
 REVIEWED BY: Matthew Milton Monday, CIH, Dept. Head

*Minimum Reporting Limit: 20 μg Total Lead. Effective 3/6/01, EPA Lead Hazard Standards: 40 $\mu\text{g}/\text{ft}^2$ for floors and 250 $\mu\text{g}/\text{ft}^2$ for interior window sills, 400 $\mu\text{g}/\text{ft}^2$ for window troughs. Industrial projects may have limits established per project. *For true values, assume two (2) significant figures.*

Appendix D

Site and Floor Plan

Insert site and floor plans indicating the locations of XRF testing, soil lead and dust lead sampling performed at this property.

Appendix E

Scope of Renovation Work, As Provided to Assessor

If applicable, insert governing authority's supplied scope of planned renovation work on this page and all additional pages necessary.

Appendix F

Copy of Risk Assessor's License/Certification

NOTE: In this age of electronic alteration and reproduction, HUD encourages all lead-based paint professionals to give serious consideration to the issue of whether they wish to attach photocopies of their certification(s) or license(s).

Insert copy of State/EPA Risk Assessor license/certification.

Appendix G

Copy of Firm's Lead Activity License/Certification

Insert copy of firm's lead activity license/certification.

Appendix H

Copy of XRF Training Certificate and XRF Performance Characteristics Sheet

Insert copy of XRF training certificate.

Insert PCS. (If more than one XRF model was used, insert the PCS for each.)

Appendix I
“LEAD SPEAK” – A Brief Glossary

Abatement: A measure or set of measures designed to permanently eliminate lead-based paint hazards or lead-based paint. Abatement strategies include the removal of lead-based paint, enclosure, encapsulation, replacement of building components coated with lead-based paint, removal of lead-contaminated dust, and removal of lead-contaminated soil or overlaying of soil with a durable covering such as asphalt (grass and sod are considered interim control measures). All of these strategies require preparation; cleanup; waste disposal; post-abatement clearance testing; recordkeeping; and, if applicable, monitoring. (For full EPA definition, see 40 CFR 745.223).

Bare soil: Soil not covered with grass, sod, some other similar vegetation, or paving, including the sand in sandboxes.

Chewable surface: An interior or exterior surface painted with lead-based paint that a young child can mouth or chew. A chewable surface is the same as an “accessible surface” as defined in 42 U.S.C. 4851b(2). Hard metal substrates and other materials that cannot be dented by the bite of a young child are not considered chewable.

Deteriorated paint: Any paint coating on a damaged or deteriorated surface or fixture, or any interior or exterior lead-based paint that is peeling, chipping, blistering, flaking, worn, chalking, alligating, cracking, or otherwise becoming separated from the substrate.

Dripline/foundation area: The area within 3 feet out from the building wall and surrounding the perimeter of a building.

Dust-lead hazard: Surface dust in residences that contains an area or mass concentration of lead equal to or in excess of the standard established by the EPA under Title IV of the Toxic Substances Control Act. EPA standards for dust-lead hazards, which are based on wipe samples, are published at 40 CFR 745.65(b); as of the publication of this edition of these *Guidelines*, these are 40 µg/ft² on floors and 250 µg/ft² on interior windowsills. Also called lead-contaminated dust.

Friction surface: Any interior or exterior surface, such as a window or stair tread, subject to abrasion or friction.

Garden area: An area where plants are cultivated for human consumption or for decorative purposes.

Impact surface: An interior or exterior surface (such as surfaces on doors) subject to damage by repeated impact or contact.

Interim controls: A set of measures designed to temporarily reduce human exposure or possible exposure to lead-based paint hazards. Such measures include, but are not limited to, specialized cleaning, repairs, maintenance, painting, temporary containment, and the establishment and operation of management and resident education programs. Monitoring, conducted by owners, and reevaluations, conducted by professionals, are integral elements of interim control. Interim controls include dust removal; paint film stabilization; treatment of friction and impact surfaces; installation of soil coverings, such as grass or sod; and land use controls. Interim controls that disturb painted surfaces are renovation activities under EPA’s Renovation, Repair and Painting Rule.

Lead-based paint: Any paint, varnish, shellac, or other coating that contains lead equal to or greater than 1.0 mg/cm² as measured by XRF or laboratory analysis, or 0.5 percent by weight (5000 mg/g, 5000 ppm, or 5000 mg/kg) as measured by laboratory analysis. (Local definitions may vary.)

Lead-based paint hazard: A condition in which exposure to lead from lead-contaminated dust, lead-contaminated soil, or deteriorated lead-based paint would have an adverse effect on human health (as established by the EPA at 40 CFR 745.65, under Title IV of the Toxic Substances Control Act). Lead-based paint hazards include, for example, **paint-lead hazards, dust-lead hazards, and soil-lead hazards.**

Paint-lead hazard: Lead-based paint on a friction surface that is subject to abrasion and where a dust-lead hazard is present on the nearest horizontal surface underneath the friction surface (e.g., the window sill, or floor); damaged or otherwise deteriorated lead-based paint on an impact surface that is caused by impact from a related building component; a chewable lead-based painted surface on which there is evidence of teeth marks; or any other deteriorated lead-based paint in any residential building or child-occupied facility or on the exterior of any residential building or child-occupied facility.

Play area: An area of frequent soil contact by children of under age 6 as indicated by, but not limited to, such factors including the following: the presence of outdoor play equipment (e.g., sandboxes, swing sets, and sliding boards), toys, or other children's possessions, observations of play patterns, or information provided by parents, residents, care givers, or property owners.

Soil-lead hazard: Bare soil on residential property that contains lead in excess of the standard established by the EPA under Title IV of the Toxic Substances Control Act. EPA standards for soil-lead hazards, published at 40 CFR 745.65(c), as of the publication of this edition of these *Guidelines*, is 400 µg/g in play areas and 1,200 µg/g in the rest of the yard. Also called lead-contaminated soil.

Appendix J
Additional Lead and Lead Safety Resource Data

Key Units of Measurement

Gram (g or gm): A unit of mass in the metric system. A nickel weighs about 1 gram, as does a 1 cube of water 1 centimeter on each side. A gram is equal to about 35/1000 (thirty-five thousandths of an ounce). Another way to think of this is that about 28.4 grams equal 1 ounce.

µg (microgram): A microgram is 1/1000th of a milligram. To put this into perspective, a penny weighs 2 grams. To get a microgram, you would need to divide the penny into 2 million pieces. A microgram is one of those two million pieces.

µg/dL (microgram per deciliter): used to measure the level of lead in children’s and worker’s blood to establish whether intervention is needed. A deciliter is a little less than a half a cup.

µg/ft² (micrograms per square feet): the unit used to express levels of lead in dust samples. All reports should report levels of lead in dust in µg/ft².

mg/cm² (milligrams per square centimeter): used to report levels of lead in paint thru XRF testing.

ppm (parts per million): Typically used to express the concentrations of lead in soil. Can also be used to express the amount of lead in a surface coating on a mass concentration basis. This measurement can also be shown as: µg/g, mg/kg or mg/l.

ppb (parts per billion): Typically used to express the amount of lead found in drinking water. This measurement is also sometimes expressed as: µg/L (micrograms per liter).

EPA/HUD Lead-Based Paint and Lead-Based Paint Hazard Standards

Lead-Based Paint (may be determined in either of two ways)

- ◆ Surface concentration (mass of lead per area) 1.0 µg/cm²
- ◆ Bulk concentration (mass of lead per volume) 0.5%, 5000 µg/g, or 5000 ppm

Dust-thresholds for Lead-Contamination

- ◆ Floors 40 µg/ft²
- ◆ Interior Window Sills 250 µg/ft²
- ◆ Window Troughs (clearance examination only) 400 µg/ft²

Soil-thresholds for Lead Contamination

- ◆ Play areas used by children under age 6 400 µg/g, or 400 ppm
- ◆ Other areas 1200 µg/g, or 1200 ppm

Resources For Additional Information On Lead-Based Paint And Lead-Based Paint Hazards:

National Lead information Center & Clearinghouse:

1-800-424 LEAD

www.epa.gov/lead/pubs/nlic.htm

Centers for Disease Control and Prevention Lead Program:

www.cdc.gov/lead

Toll-free CDC Contact Center: 800-CDC-INFO; TTY 888-232-6348

Consumer Product Safety Commission

www.cpsc.gov

Toll-free consumer hotline: 1-800-638-2772; TTY 301-595-7054

Environmental Protection Agency Lead Program:

www.epa.gov/lead

202-566-0500

HUD Office of Healthy Homes and Lead Hazard Control:

www.hud.gov/offices/lead

202-402-7698

Anystate Department of Health and Environment, Lead Poisoning Prevention Program

<http://depthealth.state.an/lead/>

Hearing- or speech-challenged individuals may access the federal agency numbers above through TTY by calling the toll-free Federal Relay Service at 800-877-8339; see also <http://www.federalrelay.us/tty>.

Appendix 8.2: Example of a Risk Assessment Report for a Large Multi-family Housing Development

For a recommended format for a risk assessment report, see Chapter 5, Section VI.E, of these *Guidelines*

Appendix 9:

Lead-Based Paint Liability Insurance

I. PURPOSE OF APPENDIX

This appendix provides guidance to property owners on the purchase of liability insurance against claims as a result of:

1. A negligent act, error or omission in professional services related to lead-based paint evaluation work (lead-based paint inspection, lead-based paint risk assessment, lead-based paint testing, and clearance examinations after lead hazard control work) in the owner's housing management program (Professional Liability Coverage), and/or
2. Bodily injury or property damage resulting from the discharge, dispersal, release, or escape of lead-based paint during renovation, remodeling, maintenance, and lead hazard control work by owners as part of their housing management program (Contractor's Pollution Legal Liability Coverage).

The term "lead hazard control" includes both interim controls and abatement.

II. LEAD-BASED PAINT-RELATED WORK AND OVERVIEW OF PUBLIC HOUSING INSURANCE REQUIREMENTS

For several years, lead liability insurance has been readily available for lead-based paint inspection, risk assessment and abatement work. (Firms and individuals conducting lead-based paint inspection and risk assessment work are called consultants in this Appendix. Firms and individuals conducting abatement, interim controls and renovation work are called construction contractors or contractors in this Appendix.) Depending on the type and/or level of HUD assistance, two general categories of lead-based paint work may be performed: 1) Evaluation Work, and 2) Lead Hazard Control Work. These two categories require different insurance coverage.

The broad insurance requirements for these categories of lead-based paint work are described below. Greater detail is provided in Sections III and V of this appendix.

A. Professional Liability Coverage (Errors and Omissions, or "E&O") for Lead-Based Paint Evaluation Work:

Evaluation Work* includes:

- Clearance examinations after lead hazard control work
- Lead-Based Paint Inspection
- Lead-Based Paint Risk Assessment, including Reevaluation
- Lead-Based Paint Testing by certified renovators in unassisted housing

*Note: Proper training is required for all work listed. State or U.S. Environmental Protection Agency (EPA) certification is required for lead-based paint inspections and risk assessments, and clearance examinations after abatement work or after renovation, repair or painting work, or after lead hazard control work, or when certified renovators perform paint testing in unassisted housing, when required by regulatory, grant or contract requirements of the state, tribal or local government or of HUD or another federal agency, including certification of the individuals and the firm (or owner) by whom the certified individuals are employed. See the EPA lead web site at <http://epa.gov/lead/pubs/traincert.htm>.

- B. **Contractor Pollution Liability (“CPL”) Coverage for Lead Hazard Control Work:** HUD also recommends coverage for lead-based paint-related claims for bodily injury or property damage arising from the performance of lead-based paint-related construction or maintenance work. If the owner’s employees perform the work, the work may be covered under the owner’s General (or Umbrella) Liability policy provided that the policy will address such pollution claims, or, the owner may take out a CPL policy (perhaps, if the owner’s broker advises, as an owner-controlled policy or “OCIP”) with the owner as the Named Insured on the CPL policy. If a contractor performs the work, HUD recommends that the contractor list the owner as an Additional Insured on the contractor’s CPL policy.

Lead Hazard Control Work* includes:

Lead-Based Paint Abatement performed by certified abatement contractors working for a certified abatement firm, or by certified abatement supervisor and abatement worker employees working for the owner if the owner is itself a certified abatement firm.

Interim Controls, including Ongoing Lead-Based Paint Maintenance, and Renovation, Repair, and Painting work, performed by the owner’s employees or contractors trained in lead-safe work practices; the project supervisor must be a certified renovator if the work is covered by the EPA’s Renovation, Repair, and Painting (RRP) Rule. If the work is covered by the RRP Rule, the owner (if the work is being done by the owner’s employees) or the contractor (if not) must be a certified renovation firm.

*Note: Proper training is required for all work listed. State or EPA Certification is required for abatement work (see the EPA lead regulations web site, www.epa.gov/opptintr/lead/pubs/regulation.htm) and RRP work (see the EPA RRP Rule web site, www.epa.gov/lead/pubs/renovation.htm for the scope and requirements of that Rule). Some states require certification for some RRP or interim control work; owners should check their state requirements; see the RRP web site, above, for information on whether the state or tribal area in which the work is to be done is operating the certification program instead of EPA. HUD requires that persons performing interim controls in HUD-assisted housing be certified renovators who have been certified by either the EPA or the EPA-authorized state or tribe in which the work is to be done, as applicable, or be certified lead abatement workers. The EPA’s RRP Rule generally applies to interim control work in target housing (generally, pre-1978 housing), but EPA does not allow certified abatement supervisors/workers to do RRP work unless they are also RRP certified. For unassisted housing, the RRP training requirements apply. Owners having RRP work done should check their own insurance policies, or (if applicable) their contractor’s insurance policies to determine if they cover lead hazard control work, and, if they do, what exclusions, deductibles and/or limitations apply. For more regulatory information, see Appendix 6.

In summary, for lead-based paint evaluations or other lead-based paint-related professional services, E&O coverage, which does not exclude lead-based paint activities, is required. For lead hazard control work, CPL coverage is required. Either the “occurrence” or “claims made” form of coverage is acceptable for CPL coverage (see section on Lead Liability Coverage Issues, below). True occurrence coverage is preferable because claims by children could occur years later, perhaps even after the business has ceased operation. Moreover, statutes of limitation may in some states not begin to run against children until they reach their majority.

- C. **In-Place Lead Liability:** Although In-Place Lead Liability coverage (commonly referred to as Pollution Legal Liability, or PLL) is a different coverage than E&O and CPL, the coverage intent can be similar to E&O and CPL.

There are two reasons why property owners may want to purchase this type of policy:

1. To supplement E&O and CPL policies purchased; or
2. To provide coverage for bodily injury or property damage resulting from existing lead or lead-based paint in a property if an owner is unable to procure the required E&O or CPL coverage.

This type of policy may be purchased as a substitute provided that the policy language covers bodily injury and property damage from lead or lead-based paint on or in the owner’s buildings and if E&O and CPL are not available for purchase. These policies are normally sold for a fixed term (three/five years, etc.) on a claims made basis.

III. EXISTING COVERAGE AND POLICY FORMS

A. Existing Coverage

Lead liability coverage is often not provided under existing standard E&O policies for engineering or architectural services because the policy’s definition of “Professional Services” may not be broad enough to cover liability for lead-based paint-related work. Likewise, lead is also typically excluded in standard Commercial General Liability (CGL) coverage. Almost all CGL policies have a “pollution exclusion” provision, which excludes coverage for claims arising from “pollutants,” which can include asbestos, lead, lead-based paint, mold, or other environmental contaminants.

Therefore, the owners’ existing E&O and/or CGL may have a gap in coverage created when performing lead hazard evaluation and control work. Owners may obtain lead liability protection for their own lead-based paint-related work and require their contractors to obtain lead liability coverage for the contractors’ lead-based paint-related work performed on behalf of the owner, as discussed in detail below. Such insurance coverage can be purchased from specialty environmental carriers or risk retention groups. Subcontractors performing non-professional work should be required to present evidence that they have environmental coverage (CPL) that does not exclude coverage for lead-based paint-related claims (“lead exclusion”) and that the contractor and owner are additional insureds on the policy. As discussed above, the policy should be on a true occurrence basis.

B. Professional Liability Errors and Omissions Insurance (E&O) for Lead Evaluation Work by Property Owners' Employees, Consultants and Construction Contractors

Standard E&O insurance is intended to cover any negligent acts, errors, or omissions in rendering or failing to render the Professional Services as defined in the policy. As discussed above, owners' existing standard E&O policies are not designed to provide liability coverage for employees performing lead-based paint evaluations. Owners may purchase additional E&O insurance beyond the standard policy coverage to cover their employees or contractors for lead-based paint-related work conducted on their property. (Depending upon the market, these policies may be referred to as "miscellaneous" E&O coverage.) It is important to note that such policies should afford coverage for lead-based paint-related work in the definition of Professional Services. As of 2012, E&O coverage was available only on a "claims made" basis.

Most major carriers will refuse to add third parties as additional insureds to an E&O policy. This is a material difference between E&O coverage and CPL coverage. If the owner is added to an E&O policy as an "Additional Insured," the owner is expected to be covered for claims brought against the owner that arise directly out of work or projects performed on the owner's behalf. In other words, the "Additional Insured" owner will be protected from indirect liability arising out of the "Named Insured's" work. If this type of policy is not feasible, the owner may be able to purchase an E&O insurance policy in which the owner is the "Named Insured" and the consultant or contractor is an "Additional Insured," but the policy should be limited to lead-based paint evaluation work conducted on behalf of the owner.

Lead Evaluations by Property Owners' Employees: If lead-based paint evaluation work is conducted by employees, the owner should be the "Named Insured" on such a policy. Some insurance carriers require that each individual employee performing lead-based paint evaluation work be named on the policy as an "Additional Insured." As of the publication of this edition of the *Guidelines*, there is a benefit to naming individual employees on the policy in order to broaden the range of protection. Prior to binding coverage, the carrier may require submission of documents proving each individual employee proposed for coverage is properly trained and certified by the state or EPA. Owners should consider retaining copies of past and current employee training certificates related to EPA or State certification or licensure, and any other related documents. Carriers may also request information about the number, type and age of housing units under control of the owner applying for coverage.

Lead Evaluations by Consultants: If lead-based paint evaluation work is conducted by consultants, the consultant obtains the insurance, is the "Named Insured," and should list the owner as an "Additional Insured" on the policy. Most major carriers will refuse to add third parties as additional insureds to an E&O policy. This is a material difference between E&O coverage and CPL coverage. In the uncommon case that the owner is added to a consultant's E&O policy as an "Additional Insured," the owner will be covered for claims brought against the owner that arise directly out of work or projects performed by the consultant on the owner's behalf. In other words, the "Additional Insured" owner will be protected from indirect liability arising out of the "Named Insured's" (i.e., consultant's) work. If this type of policy is not feasible, the owner may be able to purchase an E&O insurance policy in which the owner is the "Named Insured" and the consultant is an "Additional Insured," but the policy should be limited to lead-based paint evaluation work conducted on behalf of the owner.

Lead Evaluations by Construction Contractors: It should be noted that non-professional contractors will normally not have E&O coverage. Certified renovation firms doing paint testing in unassisted housing using certified renovators who are not lead-based paint inspectors or risk assessors should have CPL without a lead exclusion.

Housing Authorities (HAs) and Resident Management Corporations (RMCs): The duties of an RMC hired by an HA are similar to those of a real estate management firm. If the HA has contracted for an RMC to manage a building or project, the owner should purchase an E&O insurance policy in which the HA is the "Named Insured" and the RMC, and its subcontractors, if applicable, are "Additional Insureds." If this type of policy is not available, the RMC should purchase an E&O insurance policy in which the HA is an "Additional Insured." The policy purchased by the RMC would be limited to lead-based paint evaluation work conducted on behalf of the HA, in connection with the HA's contract related to lead-based paint evaluation work. (Note: E&O coverage for non-professionals (HA, RMCs, etc.) may be difficult to obtain or, depending upon the market, may not be available. The default would be to a CPL or PLL type situation; but remember: these coverages are not identical.)

Although the Lead Safe Housing Rule does not categorize visual assessment as a lead-based paint evaluation method, owners may choose to purchase an E&O policy that covers the work of visual assessors, if the owner determines that such coverage is needed and if the coverage is available.

C. **Contractor's Pollution Liability (CPL) Insurance for Lead Hazard Control Work by Property Owners' Employees and Contractors**

Contractors Pollution Liability (CPL) insurance is intended to cover property damage and bodily injury claims resulting from the discharge, dispersal, release, or escape of lead or lead-based paint during lead hazard control work by employees, interim control contractors or abatement contractors. It is important to note that such policies must afford coverage for lead and lead-based paint in the definition of "pollutants."

Lead Hazard Control Work by Owners' Employees: If lead hazard control work is conducted by the owner's employees, the owner should be the "Named Insured" on such a policy. Some insurance carriers require that each individual employee performing lead hazard control work be named on the policy as an "Additional Insured." (See comments above.) Prior to binding coverage, the carrier may require submission of documents proving each individual employee proposed for coverage is properly trained and/or certified, as applicable, by the state or EPA. Owners should retain copies of past and current employee training certificates related to EPA or State certification or licensure, and any other related documents. Carriers may also request information about the number, type and age of housing units under control of the owner applying for coverage.

Lead Hazard Control Work by Contractors: If lead hazard control work is conducted by interim control contractors or abatement contractors separate from the owner, the contractor obtains the insurance, with the contractor being the "Named Insured" and the owner listed as an "Additional Insured" on the policy. Such contractors must be properly trained and/or certified, as applicable. If the owner is added to a contractor's CPL policy as an "Additional Insured," the owner will be covered for claims that arise directly out of work or projects performed by the contractor on the owner's behalf. In other words, the "Additional Insured" owner wants to be protected from indirect liability arising out of the "Named Insured's" (i.e., contractor's) work. If this type of policy is not feasible, the owner can purchase a CPL insurance

policy in which the owner is the “Named Insured” and the interim control (trained in Lead Safe Work Practices) contractor or abatement contractor is an “Additional Insured,” but the policy should be limited to lead hazard control work conducted on behalf of the owner.

Housing Authorities (HAs) and Resident Management Corporations (RMCs): The duties of the RMC hired by an HA are similar to those of a real estate management firm. If the HA has contracted for an RMC to manage a building or project, the HA should purchase a CPL insurance policy in which the HA is the “Named Insured” and the RMC, and its subcontractors, if applicable, are “Additional Insureds.” If this type of policy is not available, the RMC should purchase a CPL insurance policy in which the RMC is the “Named Insured” and the HA is an “Additional Insured.” The policy purchased by the RMC would be limited to lead hazard control work conducted on behalf of the HA, in connection with the HA’s contract related to lead hazard control work.

D. Claims-Made and Occurrence Coverage for Lead Hazard Control Work

These are two types of policy coverage for E&O and CPL policy forms. Each type of policy contains “triggers” that describe when a claim or lawsuit may be covered. A “claim” is a demand for payment under the policy. An “occurrence” is frequently defined as an exposure, event or accident, including continuous or repeated exposure to the same general harmful conditions.

In an “Occurrence” policy, as long as the circumstance resulting in a claim occurs during the policy period, a claim may be covered regardless of when it is made against the insured and reported to the insurer. This is so even if the insured business ceases operations, files for bankruptcy or changes carriers several times over a period of years. Occurrence policies are preferable because they contain an indefinite claim-reporting period. However, as of 2012, occurrence forms are typically difficult to obtain from specialty insurance companies or risk retention groups covering lead-based paint-related work.

“Claims-Made” policies require that the circumstances resulting in a claim must occur after the retroactive date specified in the policy declarations, and the claims must be made against the insured and reported to the insurer within the policy period. “Some “Claims-Made” policies have a reporting period extending after the end of the policy period, during which a claim can be made and reported to the insurer, for a circumstance that occurred during the policy period. An extended reporting period is sometimes referred to as “tail” coverage. Tail coverage is usually expensive and the coverage will still cease in relatively short order. See discussion above concerning children, claims and statutes of limitations. Changing carriers will rapidly end coverage, but the insured must address this through having the new carrier extend the retroactive date to the retroactive date of the expiring/non-renewed policy. The potential issue in such situations is whether or not the new carrier is willing to do so. (see Section V).

Either “Claims-Made” or “Occurrence” coverage for lead hazard control insurance may be suitable. See discussions above, however. HUD strongly recommends that owners and their contractors purchase occurrence-based lead liability coverage, when available, instead of a “claims-made” type of policy with an extended reporting period. Because HUD recognizes that, as of 2012, when this guidance was published, occurrence policies are difficult to obtain, it encourages property owners to engage their insurers on the issue of the availability of occurrence policies. If a “Claims-Made” policy is purchased, the policy should provide an automatic extended reporting period of at least thirty days for no additional premium. It would be in the best interest of the owner if the policy should also allow for the purchase of an optional extended reporting period of at least one year. Because the occurrence type of coverage may not be available for certain types of work and operations,

either type of coverage will suffice. The lead liability coverage must remain in effect during the entire period of the lead-based paint evaluation and control work. The insurance certificate evidencing the claims made coverage should show the policy inception and expiration date, and should contain a provision requiring the broker to notify the additional insured of any cancellation, early termination or material alteration in the policy (such as a claim eroding limits available under the policy.)

Completed Operations Coverage.

CPL coverage should include “completed operations” coverage (see Section V). Even though the operations are deemed to be “completed” by the contractor, the loss or injury is deemed to be as a result of those operations. This type of coverage is often covered under general liability insurance, but sometimes is purchased by a contractor/manufacturer over and above general liability to cover loss or injury that occurs off the insured’s property.

E. Proof of Contractor Coverage and Recordkeeping

Whenever an owner requires a contractor to purchase E&O or CPL insurance, proof of the insurance should be provided to the owner prior to the commencement of work. A copy of a Certificate of Insurance identifying the owner as an “Additional Insured” should be submitted and retained by the owner as an important record associated with the lead-based paint work being performed. Owners must retain a current certificate of insurance as long as the owner performs or contracts for lead-based paint-related work. Owners should keep lead-based paint-related records for ongoing lead-based paint maintenance work in public housing for at least three years and, preferably, for as long as the owner controls the property.

The certificate should show the insurance policy period corresponding to the date(s) of work performed by the insured contractor. Certificates should also state the carrier, type of insurance, policy number, policy effective date and expiration date, and limits of liability. The certificate should also include a minimum 30-day notice of cancellation requirement to the owner.

F. Explanation of Policy Limits and Aggregates

Most E&O and CPL policies have two stated limits of liability:

1. The “per occurrence” or “per claim” limit. As discussed above, a “claim” is a demand for payment under the terms of the policy. An “occurrence” is frequently defined as an exposure, event or accident, including continuous or repeated exposure to the same general harmful conditions. The “per occurrence” or “per claim” limit is the maximum amount the insurer will pay for a single covered claim or occurrence.
2. The “aggregate limit.” This is the maximum overall limit of liability for a policy period. The aggregate policy limit is intended to be the maximum amount paid out for claims arising out of all occurrences that take place during the policy period. For example, if the contractor’s liability policy has a \$1,000,000 “aggregate” policy limit and other unrelated claims totaling \$600,000 have already been made against the policy, only \$400,000 is potentially available to cover additional claims arising out of the owner’s lead-based paint-related work.

IV. REQUIRED POLICY LIMITS AND DEDUCTIBLES

- A. **Lead-Based Paint Evaluations and Other Professional Services:** Whether the owner's employees or its contractor physically performs the evaluation work (lead-based paint inspections, lead-based paint risk assessments, lead-based paint testing, and clearance examinations after lead hazard control work), HUD recommends that any policy insuring for evaluation work comply with the minimum requirements below. (See discussion above for the source of the insurance requirement.)
1. **Form:** The policy form used to cover evaluation work should be an E&O form, which includes lead-based paint evaluation work in the definition of "Professional Services" (or similar). If a "Claims-Made" E&O policy is purchased, the policy should provide an automatic extended reporting period of at least thirty days for no additional premium. The policy should also allow for the purchase of an optional extended reporting period of at least one year. (Note: Occurrence E&O is not readily available in the marketplace as of the time of publication of this edition of the *Guidelines*)
 2. **Limits of Liability for Evaluation Work:** The limits of liability should be a minimum of \$1,000,000 per claim or per occurrence. If the policy contains an aggregate limit, the minimum limit should be \$1,000,000. The owner may choose higher limits of liability based on claims history in its area or its own claims experience.
 3. **Deductible:** If a deductible is applicable, it should not exceed \$5,000 per claim or per occurrence. Deductibles of less than \$5,000 may be elected if the owner chooses, although this may cause an increase in premium which may be passed through in some form to the owner.
 4. **Cancellation:** The insurance company should provide the owner (as the "Named Insured or "Additional Insured") with a notice of policy cancellation for any reason; a minimum of 10 days advance notice before cancellation for non-payment of premium; and a minimum of 30 days advance notice before cancellation is effective for any reason other than non-payment of premium. The broker's certificate should confer upon the broker the duty to also notify the owner of these developments – as well as any material change in policy limits or coverages.
- B. **Lead Hazard Reduction Work:** Whether the owner or its contractor physically performs the lead hazard control work (abatement or interim controls, including on-going lead-based paint maintenance), the owner should consider the recommendations below for any policy insuring owners for lead hazard control work.
1. **Form:** The policy form used to cover lead hazard control work should be a Contractor Pollution Liability (CPL) policy form that includes lead and lead-based paint in the definition of "pollutants" (or similar characterization). If a "Claims-Made" CPL policy is purchased, the policy should provide an automatic extended reporting period of at least thirty days for no additional premium. The policy should also allow for the purchase of an optional extended reporting period of at least one year.
 2. **Limits of Liability for Lead Hazard Control Work:** The limits of liability should be a minimum of \$1,000,000 per claim or per occurrence. If the policy contains an aggregate limit, the minimum acceptable limit should be \$1,000,000. The owner may choose higher limits of liability based on claims history in its area or its own claims experience.
 3. **Deductible:** If a deductible is applicable, it should not exceed \$5,000 per claim or per occurrence. Deductibles of less than \$5,000 may be elected if the owner chooses, although this may cause an increase in premium which may be passed through in some form to the owner.

4. **Cancellation:** The insurance company should provide the owner (as the “Named Insured or “Additional Insured”) notice of policy cancellation for any reason; a minimum of 10 days advance notice before cancellation for non-payment of premium; and a minimum of 30 days advance notice before cancellation is effective for any reason other than non-payment of premium. The broker’s certificate should confer upon the broker the duty to also notify the owner of these developments – as well as any material change in policy limits or coverages.

C. **Recommended Minimum Characteristics for Insuring Entities**

The insurer should be approved to issue insurance policies in the State, District or territory in which the owner is domiciled. Alternatively, the insuring entity can be a domestic risk retention group operating under the Federal Liability Risk Retention Act. It should be understood that pollution E&O policies, PLL policies and other policies may be issued on a “surplus lines” basis (also called by the industry term “non-admitted paper”), which may have flexible language but does not require the state insurance commission’s approval, and, as a result, is generally not able to access state funds in the event of the insolvency of the carrier or if the carrier goes out of business.

The insurer should have a minimum A.M. Best Financial Strength Rating of at least A (the highest rating is A++), and an A.M. Best Financial Size Category of at least VII (out of XV). The ratings and categories are defined by A.M. Best Company, a credit rating agency serving insurance sectors. For more information, see its website at <http://ambest.com>.

V. DEFINITIONS

For the purpose of this Appendix, definitions are provided for the terms below. For regulatory definitions, please see the applicable regulations.

Clearance examinations after lead hazard control work: Visual examination and collection of lead dust samples by an inspector or risk assessor, or, in some circumstances, a sampling technician, and analysis by a EPA-recognized laboratory upon completion of an abatement project, interim control intervention, maintenance or renovation job that disturbs lead-based paint (or paint presumed to be lead-based.) For abatement projects, the clearance examination is performed to ensure that lead exposure levels do not exceed clearance standards established by the EPA at 40 CFR 745.227(e)(8)(viii); HUD’s dust-lead standards for clearance after interim control projects are found at 24 CFR 35.1320(b)(2)(i).

Completed Operations coverage: An insurance product that covers the liability incurred by a contractor for property damage or injuries that may happen to a third party once contracted operations have ceased or been abandoned. Even though the operations are deemed to be “completed” by the contractor, the loss or injury is deemed to be as a result of those operations. Completed operations insurance contracts are applied to construction products or the manufacturing of consumer goods and medicines.

Lead-Based Paint Inspection: A surface-by-surface investigation to determine the presence of lead-based paint (in some cases including dust and soil sampling) and a report of the results.

Lead-Based Paint Risk Assessment: An on-site investigation of a residential dwelling to determine the existence, nature, severity, and location of lead-based paint hazards. Risk assessments, which must be conducted by a certified risk assessor, include an investigation of the age, history, management, and maintenance of the dwelling, and the number of children under age 6 and women of childbearing age who are residents; a visual assessment; limited randomized environmental

sampling (i.e., collection of dust wipe samples, soil samples, and deteriorated paint samples); and preparation of a report identifying abatement and interim control options based on specific conditions. HUD's Lead Safe Housing Rule requires risk assessments for certain types and amounts of HUD assistance; in these cases, a risk assessment must be no more than 12 months old to be considered current.

Lead-Based Paint Testing: The process of determining, by a certified lead-based paint inspector or risk assessor, or by a certified renovator in unassisted housing, the presence or absence of lead-based paint on deteriorated paint surfaces or painted surfaces to be disturbed or replaced.

Reevaluation: The combination of a visual assessment and collection of dust and, as appropriate, soil samples performed by a certified risk assessor to determine if the housing is free of lead-based paint hazards, and determine whether previously implemented lead-based paint hazard control measures are still effective.

Retroactive Date: A provision found in many claims-made policies that eliminates coverage for injuries or damage that occurred prior to a specified date even if the claim is first made during the policy period. A retroactive date is not required. If one is shown on the policy, any claim made during the policy period on a loss that occurred before the retroactive date will not be covered.

VI. COORDINATION WITH COUNSEL ON INDEMNITY/HOLD HARMLESS LANGUAGE

It is important that insurance provisions be coordinated with the indemnity/hold harmless/defense provisions in the services or work agreement. The owner should retain experienced contract and insurance counsel to make sure that, to the extent reasonably possible, the risks shifted under the indemnity provisions are (A) enforceable under applicable state law and do not run afoul of "anti-indemnity" laws or cases; and (B) are funded as "insured contracts" under the relevant policies. Overextended indemnities create uninsurable risks which, in turn, raise questions about the ability of the claimant to collect.

Appendix 10: (Reserved for future use)

Appendix 10 of the 1995 *Guidelines*, which was a list of questions and answers on sampling lead-based paint hazardous waste, has been deleted because EPA now includes waste from lead hazard reduction work under the household exemption for hazardous waste disposal requirements. See Chapter 10 for guidance on handling such waste.

Appendix 10.1: State and Territorial Hazardous Waste Management Agencies

EPA now includes waste from lead hazard reduction work under the household exemption for hazardous waste disposal requirements. Therefore, Appendix 10.1, a list of hazardous waste management agencies, has been deleted. See Chapter 10 for guidance on handling waste. For a current list of State and territorial waste management agencies, see the EPA website at <http://www.epa.gov/osw/wyl/stateprograms.htm>. [Accessed 7/28/2012; this site may be moved or deleted later.]

Appendix 11:

One-Hour Waiting Period

Rationale for Clearance Sampling

For research supporting the one-hour waiting period, see Choe, 2000, in the list of references in Chapter 15, Clearance.

Appendix 12:

Statistical Rationale for Sample Sizes and Percentages Used in Guidance for Inspecting in Multi-Family Housing

This appendix presents the statistical rationale and calculations used to develop sample sizes (number of units to be tested) in multi-family housing. (See Note 1, below.) The samples sizes apply both to inspections for lead-based paint and to post-abatement dust clearance testing in multi-family housing. The appendix also presents the detection capability of the sampling scheme, that is, the probability that the scheme will successfully detect various levels of contamination in the housing development tested.

12A.1 Sample Size Calculations

To determine the applicable sample size using the methods of this appendix, the housing units must first be properly grouped. For lead-based paint inspections, similar units and buildings should be grouped based on common construction, floor plans, and painting history. This type of grouping will make it less likely that lead-based paint will be missed in the testing. Likewise, for dust clearance testing, units and buildings that have similar construction and were cleaned in the same manner should be grouped for sampling purposes.

Because the sampling scheme applies to both testing for lead-based paint inspections and dust clearance testing, the term “the HUD standard” will be used to mean either 1.0 mg/cm² for lead-based paint inspections or the applicable clearance standard for dust testing. The term “component” means a floor, windowsill or window well for dust clearance testing, and means any painted building component for lead-based paint inspections.

The basic specification for the sampling scheme is that it achieves 95% confidence that at least 95% of the units meet the HUD standard. This means that, if all units sampled meet the HUD standard for all components tested, there is 95% confidence that fewer than 5% of the units in the development have one or more components in violation of the HUD standard, assuming no with-in unit sampling error and no measurement error. An alternate interpretation is that up to a 5% chance of missing some lead in up to 5% of the units is allowed. In a large development, 5% of the units might be a large absolute number, however, so the total number of leaded units that might escape detection has been limited to 50. This leads to the following quantitative prescription for the sampling plan:

TEST THE SMALLEST NUMBER OF UNITS WITH THE PROPERTY THAT, IF ALL TESTED UNITS ARE AT OR BELOW THE HUD STANDARD FOR ALL COMPONENTS, THERE IS 95% CONFIDENCE THAT THE NUMBER OF UNITS WITH AT LEAST ONE COMPONENT AT OR ABOVE THE HUD STANDARD IS LESS THAN 50 UNITS OR 5%, WHICHEVER IS SMALLER.

As an example, 56 units should be tested in a 600-unit development. Sample sizes were taken from Table 7.3 of Chapter 7 (or Table IV in this appendix). If no lead (above the HUD standard) is found in any of the 56 tested units, the owner of the development can be 95% confident that less than 30 units (the lesser of 50 and 5% of 600) have lead above the HUD standard. As a second example, 232 units should be tested in a 4000 unit development. If all are below the dust clearance HUD standard for all tested floors, windowsills and window troughs, there is 95% confidence that less than 50 of the 4000 units (the lesser of 50 and 5% of 4000) have any lead dust levels at or above the applicable HUD standard. Note that developments with 20 or fewer units, all units should be tested and the classification rules for single-family housing apply.

The statistical calculations required to determine the number of units to be tested, based on the criterion above, are fairly straightforward. For the sake of brevity, call a unit with one or more components with lead-based paint (or dust lead, as the case may be) at or above the HUD standard a "leaded unit." Make the following definitions:

N = Total number of units in the development;

k = Maximum allowable number of leaded units;

n = Smallest number of units which must be tested to provide 95% confidence that the total number of leaded units is "k" or less, based on finding no leaded units in the sample tested.

For example, if 95% confidence is required that less than 5% of 300 units have lead, then k = 14.

If 95% confidence is required that fewer than 50 units have lead out of 4000 units is required, then k = 49.

In the usual statistical convention, "n" is defined as the smallest integer for which the probability of obtaining no positive results in a simple random sample of size "n" from a population of size "N", of which k+1 are positive, is less than 0.05. (See Note 2, below.) When k+1 of "N" total are positive, the probability of observing no positive results in a simple random sample of size "n" is given by the hypergeometric formula¹:

$$\frac{[(N-k-1)...(N-k-n)]}{[(N)(N-1)...(N-n+1)]}$$

The required value of "n" is obtained by successively evaluating this expression for n = 1, 2, 3,..., until its value first drops below 0.05. The calculations were performed in SAS[2], using the hypergeometric distribution function[1]. Table I shows the exact values of "k" and "n" for selected values of "N".

In developing the sample sizes for Table 7.3 of Chapter 7, two refinements to the calculations were made. First, because of the discrete nature of the problem, it is possible for the sample size to decrease when the total number of units increases. To see how this happens, suppose that a building has 40 units. Since 5% of 40 is two, the maximum number of leaded units allowed is 1. However, if the building has 41 units, 5% of 41 is 2.05, so the maximum number of leaded units is 2. Since it is obviously easier to detect 2 units out of 41 than 1 out of 40, the minimum sample size for a building with 41 units is smaller than the minimum sample

size for a building with 40 units. Specifically, the exact sample size for 40 units is 31, while the exact sample size for 41 units is 26. The same problem occurs every time the number of units is a multiple of 20. Since it is extremely counter-intuitive for the sample size to decrease when the number of units increases, the additional requirement that the sample size never decrease was imposed. The result of this requirement, which can be observed clearly in Table 7.3, is that the sample size remains constant for some time beginning at each multiple of 20.

The second refinement to the calculation was to calculate a percentage of units to be sampled when the total number of units is very large. When the total number of units is 1,000 or greater, the maximum acceptable number of leaded units is 49. Suppose that a proportion "P" of the N units is to be tested when N is large. Then, when the number of leaded units is 50, the minimum unacceptable number, the probability that zero leaded units will be found in the sample can be approximated by $(1-P)^50 = 0.05$ if $P=0.058$. (The ratio of n to N in Table I is approximately 0.058 for N greater than 1000). Thus, the limiting percentage for the sample size is 5.8%. In Table 7.3, the sample size is taken as 5.8% of the number of units, rounded to the nearest whole number, when N is 1,040 or larger.

12A.2 Detection Capability of the Sampling Scheme

By the detection capability of the sampling scheme is meant the probability that the sample contains at least one leaded unit when leaded units are present. Thus, the detection capability is the probability that a problem (lead-based paint or dust above the applicable HUD standard) will be detected in the development, in the sense of showing up in at least one of the units in the sample.

The detection capability of the sampling scheme depends on the total number of leaded units in the development as a whole. Clearly, the more leaded units there are, the better the chance that they will appear in the sample. When the number of leaded units is $k+1$ (in Table I), the detection capability is, by definition, (slightly) greater than 95%. In general, when the number of leaded units is "L", the detection capability is calculated from the formula

$$1 - \frac{[(N-L)(N-L-1)\dots(N-L-n+1)]}{[(N)(N-1)\dots(N-n+1)]}$$

where "N" and "n" are, respectively, the total number of units in the development, and the sample size. Table II shows the number of leaded units that must be present in the development as a whole for the detection capability to be 50%, 75%, 90%, 95%, 97.5%, or 99%.

Table I. Calculation of Number of Units to Be Tested In Multi-family Developments.

Calculation of the Number of Units to be Tested		
N ^a	k ^b	n ^c
20	0	20
40	1	31
60	2	38
80	3	42
100	4	45
200	9	51
300	14	54
400	19	55
600	29	56
1,000	49	57
1,500	49	86
2,000	49	115
2,500	49	144
3,000	49	174
3,500	49	203
4,000	49	232
4,500	49	261
5,000	49	290

^aN = Number of Units in the Development;

^bk = Maximum Allowable Number of Leaded Units;

^cn = Number of Units to be Tested

Tables II and III give probabilities of finding at least one lead unit in the tested sample. This does not mean that all, or even most, of the lead units will be sampled. To achieve this would require virtually 100% sampling. The expected percentage of the lead units that will be sampled is equivalent to the sampling percentage, i.e., the sample size as a percentage of the number of units in the development. For example, in a 100-unit development, 45 units are sampled (highlighted in yellow in Table I). Thus, 45% of the lead units would also be expected to be sampled, on average. In a 1,000-unit development, an average of 5.7% of the lead units would be sampled.

Table II. Calculation of Number of Lead Units Which Must Be Present in the Development as a Whole for Various Levels of Detection Capability.

Na	nb	Detection Capability					
		50%	75%	90%	95%	97.5%	99%
20	20	1	1	1	1	1	1
40	31	1	1	2	2	3	3
60	38	1	2	3	3	4	5
80	42	1	2	3	4	5	6
100	45	2	3	4	5	6	8
200	51	3	5	8	10	12	15
300	54	4	7	12	15	18	23
400	55	5	10	16	20	25	30
600	56	7	14	23	30	37	45
1,000	57	12	24	39	50	61	75
1,500	86	12	24	39	50	61	76
2,000	115	12	24	39	50	61	76
2,500	144	12	24	39	50	62	76
3,000	174	12	24	39	50	62	76
3,500	203	12	24	39	50	62	76
4,000	232	12	24	39	50	62	76
4,500	261	12	24	39	50	62	76
5,000	290	12	24	39	50	62	76

^aN = Number of Units in the Development;

^bn = Number of Units Tested

As an example, the detection capability of the scheme in a 600-unit development is 99% when the development contains 45 leaded units (highlighted in yellow in Table II). This means that the sample of 56 units in a 600-unit development is 99% certain to include at least one of the 45 leaded units. Notice that the numbers are almost exactly the same for all developments with 1,000 units or more. This reflects the design decision that the number of leaded units which may be missed completely (with 5% probability) must be less than 50. Of course, the fixed numbers in the table reflect a decreasing percentage of the total number of units in the development. Table III shows the percentage of leaded units that must be present to achieve the various detection capabilities.

Table III. Calculation of Percentage of Leaded Units Which Must Be Present to Achieve the Various Detection Capabilities.

N ^a	n ^b	Detection Capability					
		50%	75%	90%	95%	97.5%	99%
20	20	5.0%	5.0%	5.0%	5.0%	5.0%	5.0%
40	31	2.5%	2.5%	5.0%	5.0%	7.5%	7.5%
60	38	1.7%	3.3%	5.0%	5.0%	6.7%	8.3%
80	42	1.3%	2.5%	3.8%	5.0%	6.3%	7.5%
100	45	2.0%	3.0%	4.0%	5.0%	6.0%	8.0%
200	51	1.5%	2.5%	4.0%	5.0%	6.0%	7.5%
300	54	1.3%	2.3%	4.0%	5.0%	6.0%	7.7%
400	55	1.3%	2.5%	4.0%	5.0%	6.3%	7.5%
600	56	1.2%	2.3%	3.8%	5.0%	6.2%	7.5%
1,000	57	1.2%	2.4%	3.9%	5.0%	6.1%	7.5%
1,500	86	0.8%	1.6%	2.6%	3.3%	4.1%	5.1%
2,000	115	0.6%	1.2%	2.0%	2.5%	3.1%	3.8%
2,500	144	0.5%	1.0%	1.6%	2.0%	2.5%	3.0%
3,000	174	0.4%	0.8%	1.3%	1.7%	2.1%	2.5%
3,500	203	0.3%	0.7%	1.1%	1.4%	1.8%	2.2%
4,000	232	0.3%	0.6%	1.0%	1.3%	1.6%	1.9%
4,500	261	0.3%	0.5%	0.9%	1.1%	1.4%	1.7%
5,000	290	0.2%	0.5%	0.8%	1.0%	1.2%	1.5%

a^N = Number of Units in the Development;
 bⁿ = Number of Units Tested

For buildings or groups of similar buildings with 1,040 units or more, test 5.8 percent of the number of units, rounded to the nearest unit. EXAMPLE: If there are 2,170 units, 5.8 percent times the number of units is 125.86 units, so 126 units should be tested.

For example, in a 1,000-unit development, the detection capability of the scheme is 75% when 2.4% of the units are leaded (highlighted in yellow in Table III). That is, the sample of 57 units tested is 75% sure to contain at least one of the 2.4% of units that are leaded. Put another way, although 97.6% of the units have no lead above the HUD standard, a random sample of only 5.7% of the units has a 75% chance of finding one of the leaded units. The percentages in Table III are fixed (except for round off) for developments with 200–1,000 units, and then decline for larger developments. Again, this is the result of the design decision to fix the percentage of leaded units that may be missed (with 5% probability), for developments with 1,000 units or less. For larger developments, the number of such units is fixed, but the percentage is declining.

12A.3 Sample Size and Decision Percentages in the Multi-family Decision Flowchart

To obtain 99% confidence on conclusions made about a component type using the multi-family decision flowchart in Chapter 7, XRF readings must be taken on at least 40 components of the given type. A sample size of 40 was chosen as a minimum sample size that could be achieved in almost all cases given that at least 20 units would be tested in a multi-family housing development.

For simplicity, a single percentage was desired for declaring a component type either positive or negative in multi-family housing. The decision rule in the flowchart to declare a component type positive is based on the percentage of XRF readings classified as positive relative to the HUD standard and the decision rule to declare a component type negative is based on the percentage of XRF readings less than the HUD 1.0 mg/cm² standard, assuming a 5% false positive rate and a sample size of at least 40. Parameters provided in the *XRF Performance Characteristics Sheet* for each specific XRF instrument were developed so that the false positive rate would be 5%. Thus, for sample sizes of 40 or greater and when operating an XRF instrument as specified in the *XRF Performance Characteristics Sheet*, 99% confidence may be obtained for the following:

- ◆ At least one component of a given type has lead in paint equal or greater than the HUD standard if 15% of the components are classified as positive relative to the HUD standard.
- ◆ None of the components of a given type have lead in paint greater than the HUD standard if 100% of the XRF readings taken on the components of a given type are less than 1.0 mg/cm².

The statistical rationale for the percentages used in the decision rules of the flowchart is given below.

Positive Percentage in Multi-family Decision Flowchart

The Multi-family Decision Flowchart (Figure 7.1 of Chapter 7) gives the following rule: based on XRF readings, if 15% or more components of a given type are classified as positive relative to the HUD standard, then the inspector concludes that lead is present at 1.0 mg/cm² or greater on at least one of the components of the type tested. Assuming a true false positive rate of 5%, the 99th percentiles of the observed number and percentage of false positive classifications for several sample sizes are shown below in Table IV.

With a sample size of at least 40 for a component type and if the components all have true lead levels less than the HUD standard (1.0 mg/cm²), there is only a 1% probability of observing 15% or more positive results. In other words, if 15% or more results are actually observed on a component type, one can be 99% confident that lead is present on at least one of the components of a given type. Since 15% is the percentage that corresponds with a sample size of 40, 15% was adopted as the cutoff percentage for declaring a component type positive relative to the HUD standard in Chapter 7.

Table IV. Number and Percentage of False Positive Classifications for Several Sample Sizes Assuming True False Positive Rate of 5%

Sample Size	Number of False Positive Results	Percentage of False Positive Results
20	4	20
40	6	15
60	7	12
80	9	11
100	11	11

Negative Percentage in Multi-family Decision Flowchart

The flowchart specifies that if 100% of the XRF readings taken on components of a given type are less than 1.0 mg/cm², the conclusion is that no lead is present at or above the 1.0 mg/cm² HUD standard on the component type.

Given that the sample size must be at least 40 (as described above), suppose that exactly 1 of the 40 components tested has true lead level of 1.0 mg/cm² or greater. Then, the probability of obtaining an XRF reading less than 1.0 mg/cm² on all (100%) of the components of the given type is:

$$\Pr(\text{All XRF readings} < 1.0 \text{ mg/cm}^2) =$$

$$\Pr(1 \text{ true lead level} \geq 1.0 \text{ mg/cm}^2 \text{ has XRF reading} < 1.0 \text{ mg/cm}^2)$$

$$\text{times } \Pr(39 \text{ true lead levels} < 1.0 \text{ mg/cm}^2 \text{ have XRF readings} < 1.0 \text{ mg/cm}^2) = p_1 \times p_2^{39},$$

where

$$p_1 = \text{probability a true lead} \geq 1.0 \text{ mg/cm}^2 \text{ has XRF reading} < 1.0 \text{ mg/cm}^2$$

$$p_2 = \text{probability a true lead} < 1.0 \text{ mg/cm}^2 \text{ has XRF reading} < 1.0 \text{ mg/cm}^2$$

The maximum value of this expression using results from XRF instruments examined by EPA in a large field study [3a, 3b] was 0.017. Thus, if one or more of the 40 components is truly positive (lead level 1.0 mg/cm² or greater) relative to the HUD standard, there is less than a 2% chance of obtaining XRF readings less than 1.0 mg/cm² on all (100%) components of the component types. This means that, whenever all XRF readings on a component of a given type are less than 1.0 mg/cm², there is at least 98% confidence that none of the 40 components have true lead above 1.0 mg/cm².

With the application of the flowchart and with a sample size of 40, there is a very high probability (at least 98 percent) that a tested component type will be correctly classified. Combined with the 95 percent probability that at least one leaded component will be selected for inspection by the sampling scheme described above when 5 percent or more of the components have lead-based paint at or above 1.0 mg/cm², the procedure provides an overall confidence level of between 93 percent and 95 percent.

12A.4 Sample Size as a Function of Multifamily Development Size for 1960-1977 Developments

For 1960-1977 building developments, a similar procedure is followed except the quantitative prescription would be to: Test the smallest number of units with the property that, if all tested units are at or below the HUD standard for all components, there is 95% confidence that the number of units with at least one component at or above the HUD standard is less than 100 units or 10%, whichever is smaller. The SAS^[2] program used to perform this calculation for pre-1960 and 1960-1977 multi-family buildings with 10 to 1040 units is below.

For 1960-1977 building developments, when the total number of dwelling units is 1,000 or greater, the maximum acceptable number of leaded units is 99. Suppose that a proportion "P" of the units is to be tested when "N" is large. Then, when the number of leaded units is 100, the minimum unacceptable number, the probability that zero leaded units will be found in the sample can be approximated by $(1-P)^{100} = 0.05$ if $P = 0.029$. (The ratio of n to N in Table 7.3 is approximately 2.9%. In Table 7.3, the sample size is taken as 2.9% of the number of units, rounded to the nearest whole number, when N is 1,040 or larger.)

```
*****;
**Sample Size as a Function of Multi-family Development Size ***,
**[SAS Program]*****;
*****;
title 'Basis For Table 7.3 of the HUD Guidelines';
*****;
*****;
**Output Variables: ***,
** capn = # units in building ***,
** k1= Pre 1960 Max Allowable # leaded units ***,
** k2= 1960-1977 Max # Allowable leaded units ; ***,
** nc05=Pre 1960 # units to test in a building of size "capn"***,
** nc10=1960-77 # units to test in a building of size "capn" ***,
*****;
**Other (working) Variables: ***,
** n = # units tested in a building of size "capn" ***,
```

```

** r1=probability of obtaining no positive results in a ***;
** sample of size "n" from a population of size "capn" ***;
** of which "k1+1" are positive ***;
** r2=probability of obtaining no positive results in a ***;
** sample of size "n" from a population of size "capn" ***;
** of which "k2+1" are positive ***;
*****;
data set1;
**loop over all possible size buildings*****;
do capn=10 to 1040;
label capn='# units in building';
**determine the maximum allowable # of leaded units*****;
k1=ceil(capn*0.05)-1;
if k1>49 then k1=49;
label k1='Pre 1960 Max # leaded units';
k2=ceil(capn*0.10)-1;
if k2>99 then k2=99;
label k2='1960-1977 Max # leaded units';
**determine the # of units to sample for pre 1960 units*****;
n=1; r1=1;
****loop through until r1 falls below 0.05 *****;
* do while (round(r1,.00000001)>=.0500 and n<=capn);
do while (r1>=.0500 and n<=capn);
if (capn-(k1+1)>=n) then r1=probhypr(capn,(k1+1),n,0);
nc05=n;
n=n+1;
end;
**determine the # of units to sample for 1960-1977 units*****;
n=1; r2=1;
****loop through until r2 falls below 0.05 *****;
* do while (round(r2,.0001)>=.0500 and n<=capn);
do while (r2>=.0500 and n<=capn);
if (capn-(k2+1)>=n) then r2=probhypr(capn,(k2+1),n,0);
nc10=n;
n=n+1;
end;
output;
end;
label nc05='Pre 1960 # units to test';

```

```

label nc10='1960-1977 # units to test';
run;
title2 'Estimates Based on the Hypergeometric Distribution';
proc print label noobs;
  var capn k1 nc05 k2 nc10;
run;
****Add the non-decreasing sample-size requirement*****;
data set2;
  set set1;
  if _N_=1 then do;
    q05=nc05;
    q10=nc10;
  end;
  else do;
    q05=max(nc05,q05);
    q10=max(nc10,q10);
  end;
  retain q05 q10;
run;
proc sort data=set2;
  by q05 q10;
run;
proc means noprint;
  var capn;
  by q05 q10;
  output out=out2 min=min5 max=max5;
run;
data out2;
  set out2;
  if min5^=max5 then range5=compress(min5||"-"||max5); else range5=put(min5,5.);
run;
title2 'Estimates for Table 7.3 (adjusted to be non-decreasing)';
proc print label noobs;
  var range5 q05 q10;
label q05='Pre 1960 # units to test';
label q10='1960-1977 # units to test';
label range5='# units in building';
run;

```

NOTES:

1. The primary contributor to the programming, data analyses and preliminary drafting of this Appendix 12 was Sherry L. Dixon, Ph.D., of the National Center for Healthy Housing, whose work on this statistical rationale is appreciated.
2. $k+1$ is used to determine the probability for at most k positive values. This assures that the occurrence of k positive values will have probability less than 0.05.

References

- ¹ W. Feller (1968). *An Introduction to Probability Theory and its Applications, Volume I*, Third Edition, Wiley, New York. ISBN: 978-0-471-25708-0. <http://www.wiley.com/WileyCDA/WileyTitle/productCd-0471257087.html>
- ² SAS Institute Inc., SAS Campus Drive, Building T, Cary, NC 27513-8617. <http://www.sas institute.org/index.shtml>
- ^{3a} D. C. Cox, F. G. Dewalt, M. M. Haugen, R. A. Koyak, R. L. Schmehl. A field test of lead-based paint testing technologies: Summary report (May 1995). U.S. Environmental Protection Agency contract EPA-68-CO-0137. <http://www.epa.gov/lead/pubs/summary.txt>
- ^{3b} D. C. Cox, F. G. Dewalt, M. M. Haugen, R. A. Koyak, R. L. Schmehl. A field test of lead-based paint testing technologies: Technical report (May 1995). U.S. Environmental Protection Agency contract EPA-68-CO-0137. Available at cost from the National Technical Information Service, <http://www.ntis.gov/>, document number PB96125026.

[The websites were accessed 7/28/2012; they may be moved or deleted later.]

Appendix 13.1:

Wipe Sampling of Settled Dust for Lead Determination

Wipe samples for settled leaded dust can be collected from floors (both carpeted and uncarpeted), interior window sills, window troughs and other similar surfaces.

1. Wipe Sampling Materials and Supplies

- A. **Disposable, moistened towelettes or baby wipes.** Wipe material should meet the performance criteria found in ASTM E 1792, "Standard Specification for Wipe Sampling Materials for Lead in Surface Dust," or equivalent, as required by 40 CFR 745.63.
- B. **Non-sterilized, non-powdered disposable gloves.** Disposable gloves are required to prevent cross-sample contamination from hands. Use non-powdered gloves to preclude contamination of the wipe surface with powder from the gloves.
- C. **Hard-shell, non-sterilized resealable containers.** Use containers (such as screw-top, plastic centrifuge tubes), for storage and transporting wipe samples (interior must be capable of being rinsed in the laboratory to recover all the lead on the sample). Do not use plastic baggies to transport or temporarily hold wipe samples unless the laboratory agrees to accept samples in them beforehand.
- D. **Dust sample collection forms contained in these *Guidelines* or equivalent.** (See Forms 5.4 and 15.2.)
- E. **Masking tape, at least one inch wide, to demarcate wipe areas and/or to tape down templates.** Tape is required when templates are not available for a given wipe area, especially for narrow, confined areas, such as interior window sills and window troughs.
- F. **Labels for resealable containers and permanent marker.**
- G. **Trash bags or other receptacles (do not use trash containers at the residence).**
- H. **Measuring ruler or tape.** The measuring tool should be cleanable and capable of measuring to the nearest 1/16-inch or 1 mm.
- I. **Templates (optional).** Hard, smooth and cleanable, rectangular or square templates are recommended as a method of defining the area to be wiped on floors. (Masking tape is usually a more practical method for defining the wipe area on narrow interior window sills and window troughs.) Use either non-reusable laminated paper or cardboard, or reusable metal or plastic. Non-reusable, disposable templates are permitted so long as they are not used for more than a single surface. Templates help to assure an accurate measurement of the wipe area, can save time, and, for composite samples, help to assure uniformity of subsample areas. Templates must be larger than 0.1 sq. ft. (approximately 4 in. x 4 in. or 10 cm x 10 cm), but smaller than 2 sq. ft. (approximately 17 in. x 17 in. or 40 cm x 40 cm). Templates for floors are typically 1 sq. ft. or 900 sq. cm which is large enough to provide sufficient dust for analysis. Templates are usually not used for windows due to the variability in size and shape (use masking tape instead).

- J. **Rack, bag, or box to carry tubes (optional).**
- K. **Disposable shoe coverings (optional).** Wearing disposable shoe covers when walking from one sampling site (e.g., a building) to another helps minimize transfer of dust. Shoe covers should not be worn in vehicles. Never walk on the surface to be wiped.
- L. **Still or Video Camera (film, digital, or web) to record exact locations as well as sampling methods (optional).**

2. Single Surface Wipe Sampling Procedure

A. Outline the sample area.

1. The area to be sampled (i.e., the area to be wiped) must be a rectangle or square with measurable dimensions, so the area can be easily calculated.
2. If there is no visible dust on the surface, it is recommended that the wipe area be at least 1 sq. ft. (approximately 900 sq. cm) to obtain enough dust for analysis. If this amount of area is not available on an interior window sill or trough, make the wipe area as large as possible.

The size of the area wiped must be at least 0.1 sq. ft. (approximately 4 in. x 4 in. or 10 cm x 10 cm) in order to obtain an adequate limit of quantitation. This is because 20 µg/wipe is a typical reporting limit of laboratories using routine analytical methods, and 20 µg/0.10 square feet = 200 µg/ft², which is close to the EPA-HUD clearance criterion for interior window sills.

3. For floors and other large flat surfaces: Identify the sample area (the area to be wiped). The sample area for floor samples should be about 1 square foot (or approximately 900 sq. cm). Do not walk on or touch the sample area. It is recommended that reusable or disposable templates be used to define sample areas on large flat areas such as floors. If using a reusable template, clean it before use with one or more new wipes. Carefully place the clean template on the sample area and, to keep it from moving while wiping, tape the outside edges to the floor or weight down the template. Minimize disturbance of dust in the sample area.

If a template is not available, apply masking tape at least 1/2 inches wide to the perimeter of the sample area to form a square or rectangle. No measurement is required at this time. The tape should be positioned in a straight line and corners should be nominally at right angles.

4. For interior window sills, window troughs, and other narrow or confined rectangular surfaces: Identify the area to be wiped. If there is only one window in the room, select only half of a sill or trough, leaving the other half for a side-by-side sample if needed. Do not touch the area to be sampled. Apply two strips of adhesive tape across the sill to define a wipe area at least 0.1 square foot in size (approx. 4 inches x 4 inches or 10 cm x 10 cm), larger if possible. Templates are not recommended for window sills or troughs.

B. Inspect disposable wipes.

Inspect the wipes to determine if they are moist. If they have dried out, do not use them. When using a container that dispenses wipes through a “pop-up” lid, the first three wipes in the dispenser at the beginning of the day should be thrown away. The first wipes may be contaminated by the lid and are likely to have dried to some extent. Rotate the container before starting to ensure liquid inside the container contacts the wipes.

C. Prepare resealable containers.

Examine the hard-shell, resealable containers and make sure that they match the containers used for blind spiked wipe samples, if such samples are to be submitted to the laboratory. Partially unscrew the cap on an unused container to be sure that it can be opened.

D. Don gloves.

Don a new pair of disposable gloves. Use new gloves for each sample collected. It is not necessary to wipe gloved hands before sampling. Some people who are experienced in wipe sampling prefer to operate with just one gloved hand; some prefer a two-handed method. The single-gloved method is acceptable provided the ungloved hand does not touch the gloved hand, the wipe, the face of the template or tape that demarcates the wipe area, or the surface area to be wiped.

E. Sample floors and other large surfaces.

- ◆ Place container of wipes in the sample area.
- ◆ Select a wipe from its package and inspect it to make sure it is moist, clean, and free of fungus or other material. If it is acceptable, place the wipe at one corner of the area to be sampled with the wipe fully opened and flat on the surface.
- ◆ Make the first wipe pass, side-to-side.
- ◆ With the fingers together, grasp the wipe between the thumb and the palm. Press down firmly, but not excessively with the fingers and, if the wipe is large enough, the palm. If the sample area is a square or nearly a square, as should be the case with floor sampling, proceed to wipe side-to-side with as many “S”-like motions as are necessary to completely cover the entire sample area. (See Step 2F, below, for narrow, rectangular areas.) Exerting excessive pressure on the wipe will cause it to curl. Exerting too little pressure will result in poor collection of dust. Do not use only the fingertips to hold down the wipe, because there will not be complete contact with the surface and some dust may be missed. Attempt to pick up all dust from the sample area.
- ◆ Do not cross the template or the tape, but be sure to wipe the entire sample area. It is permissible to touch the template or tape with the wipe, but not the surface beyond.
- ◆ Make the second wipe pass, top-to-bottom.

- ◆ Fold the wipe in half with the contaminated side facing inward. (You may straighten the wipe by laying it on the sample area, contaminated side up, and folding it over.) Take care not to spill dust when folding. Once folded, place the wipe in the top corner of the sample area and press down firmly with the fingers (and the palm if the folded wipe is large enough). Repeat wiping the area with “S”-like or “Z”-like motions, but on the second pass, move in a top-to-bottom direction. Attempt to pick up all dust. Do not touch the contaminated side of the wipe with the hand or fingers. Do not shake the wipe in an attempt to straighten it out, since dust may be lost during shaking.
- ◆ Make the third wipe pass around the perimeter of the sampled area.
- ◆ Fold the wipe in half again with the dust collection side inward and repeat the wiping motion, pressing with the fingers and concentrating on collecting any remaining dust in the corners of the wipe area. If any visible dust remains, use a second wipe to collect the remaining dust, and clearly note the need to composite the wipes for analysis.
- ◆ Include spike samples in accordance with your quality assurance plan.

F. Sample interior window sills, window troughs, and other narrow rectangular areas.

If the surface is a narrow rectangle, two side-to-side passes must be made over the sample area, the second pass with the wipe folded so that the contaminated side faces inward. For an interior window sill or window trough, do not attempt to wipe the irregular edges presented by the contour of the window trough or the rounded inside edge of the interior sill. Avoid touching other portions of the window with the wipe. If there are paint chips or gross debris in the window trough, attempt to include as much of it as possible on the wipe. If it is apparent that all of the material cannot be picked up with one wipe, consider sampling only a part of the surface. Alternatively, field personnel may use a second wipe and insert it in the same container, but it is necessary first to consult with the analytical laboratory to determine if they can perform analysis of two wipes as a single sample. When performing single-surface sampling, do not use more than two single-surface wipes for each container. If heavily dust-laden, the wipe area should be smaller than if there is little or no visible dust.

G. Package the wipe sample.

After collecting as much dust as possible with the wipe, fold the wipe with the contaminated side facing inward again, and insert aseptically (without touching anything else) into the centrifuge tube or other hard-shelled container. If gross debris is present, such as paint chips in a window well, make every attempt to include as much of the debris as possible in the wipe.

H. Label the container.

Seal the centrifuge tube (or other equivalent rigid walled container) and label with the appropriate identifier. Record the laboratory submittal sample number on the field sampling form (see chapters 5 and 15). To avoid confusion, it is recommended that there be only one identifier for both the field and the laboratory.

I. Measure and record dimensions of wipe area.

After the sampling of an area has been completed, measure the dimensions of the surface area wiped to the nearest eighth of an inch using a tape measure or a ruler. Record specific measurements for each area wiped on the field sampling form. Do not estimate the surface area; measure it.

J. Prepare field blank.

Don new gloves. After collecting the last wipe sample in a dwelling unit (or in common areas within a building) but before decontamination (see Step 4, below), prepare a field blank sample. Remove a wipe from the package with a new glove, shake the wipe open, refold it in a manner similar to that used during the actual wipe sampling procedure, and then insert it into a centrifuge tube (or equivalent container used for the wipe samples) without touching any other surface or object. One blank wipe is collected for each dwelling unit or set of common areas sampled or, if more than one dwelling unit is sampled per day, one blank for every 20 field samples, whichever is less. Also, collect one blank for every lot of wipes used. Record the lot number, if available.

Analysis of the field blanks determines if the sample media is contaminated. Each field blank should be labeled with a unique identifier similar to the wipe samples so that the laboratory does not know which sample is the blank (i.e., the laboratory should be “blind” to the blank sample). A laboratory blank may also be submitted if the laboratory requests such a blank sample.

K. Complete form.

Fill out the appropriate field sampling forms (see form 5.4 or form 15.2 in these *Guidelines*) completely. Collect and maintain any field notes regarding type of wipe used, specific surface areas wiped, lot number, collection protocol, etc.

L. Dispose of Trash.

After sampling, remove all masking tape and put it in a trash bag. Before removing the last pair of disposable gloves, put all other contaminated gloves and other sampling debris used for the sampling period into a trash bag. Then remove the last pair of gloves and put them in the trash bag. Remove the trash bag when leaving the dwelling. Do not throw away gloves, wipes, etc. inside the dwelling unit where they could be accessible to young children. Besides being lead-contaminated, the plastic bag and gloves may be a suffocation hazard.

3. Composite Wipe Sampling

Whenever composite sampling is contemplated, consult with the analytical laboratory to determine if the laboratory is capable of analyzing composite samples and, if so, what wipes should be used and what annotation they add to analysis reports of composite samples. NLLAP accredited labs are required to note on the report that composite wipe analyses are not covered by their accreditation. This may cause problems with the admissibility of the data in any subsequent legal action. When conducting composite wipe sampling, the procedure stated above should be used with the following modifications:

- A. When outlining the sample areas (step 2.a, above), set up all of these areas before sampling. For each component type (i.e., floor, sill or trough), the size of the subsample areas should be equivalent, so that one room is not over-sampled.
- B. After preparing the centrifuge tube, complete the wiping procedure for each subsample (steps 2.d – 2.g, above). A separate wipe must be used for each subsample area sampled. After wiping each subsample area, carefully insert the wipe sample into the same centrifuge tube (no more than 4 wipes per tube).
- C. Once all subsamples are in the tube, label the tube. Record a separate measurement for each area that is subsampled on the field collection form (see form 5.4a or form 14.2a for a sample form). Finally, complete trash collection and disposal (step 2.p, above), making sure that no masking tape or other debris is left behind.

In addition to these procedural modifications, only composite samples from similar components. The following rules for compositing should be observed:

- ◆ Composite samples from carpeted and hard surfaces separately (e.g., a single composite sample should not be collected from both carpeted and bare floors).
- ◆ Composite samples from each different component separately (e.g., bare floors go with bare floors, carpeted floors go with carpeted floors, troughs go with troughs, etc.).
- ◆ Composite samples within a single dwelling and for from common areas within a single building.

4. Decontamination

After sampling, wash hands thoroughly with plenty of soap and water before getting into car. A bathroom in the dwelling unit may be used for this purpose, with the owner's or resident's permission. If there is no running water in the dwelling unit, wet wipes may be used to clean hands. Tools, such as reusable templates and measuring devices, should be wiped clean. During sampling, inspectors must not eat, drink, smoke, or otherwise cause hand-to-mouth contact.

5. Spiked Samples

Unless required, it is not necessary to submit spiked samples in normal practice, because laboratories certified under the National Lead Laboratory Accreditation Program (NLLAP) must participate in a proficiency testing program. However, if additional confidence in the laboratory's reliability is desired, samples spiked with a known amount of leaded dust may be inserted into the sample stream randomly by the person conducting field sampling to determine if there is adequate quality control of the digestion process at the laboratory. Dust-spiked wipe samples should be submitted blindly to the laboratory at the rate of no less than one for every fifty field samples. Any laboratory can spike wipes. The laboratory performing the analysis of the field samples can also prepare the spike sample as long as the person performing the field sampling makes the spike sample indistinguishable from the field samples. The person conducting the field sampling should take the spike sample prepared in the laboratory and re-label the container with an identifier similar to the other field samples. The spike sample wipe should not be put into another container. Spike samples should be made using the same lot as that used in the field, if convenient. You should consider preparing field spikes in addition to the spikes that are part of the laboratory quality assurance protocol.

6. Quality Assurance/Quality Control

A. Blank Samples

If more than 5 µg/wipe is detected for a blank sample collected in a specific housing development, discuss the situation with the laboratory before deciding whether to resample the site. Blank correction of wipe samples is not recommended.

B. Spiked Samples

Blind analysis of spiked samples must fall within 80 and 120 percent of the true value. If the laboratory fails to obtain readings within the QA/QC error limits:

1. Two more spikes should be sent immediately to the lab for analysis.
2. If the two additional spike samples fail, the analyses of all samples in the batch associated with the spike should be considered invalid.

A full review of laboratory procedures may be necessary. Additional samples may need to be collected from the dwelling units from locations equivalent to the locations previously sampled.

7. Other Information and Standards

See chapter 5 and chapter 15 for additional information on dust wipe sampling in practice. Additional standards for wipe sampling can be found by consulting:

- ◆ ASTM E 1728, "Standard Practice for Field Collection of Settled Dust Samples Using Wipe Sampling Methods for Subsequent Lead Determination," (<http://www.astm.org/Standards/E1728.htm>);
- ◆ ASTM E 1792, "Standard Specification of Wipe Sampling Materials for Lead in Surface Dust," (<http://www.astm.org/Standards/E1792.htm>); and
- ◆ the EPA report, "Residential Sampling for Lead: Protocols for Dust and Soil Sampling," March 1995, (EPA 747-R-95-001), which is available from the National Lead Information Center (<http://www.epa.gov/lead/pubs/nlicdocs.htm>; document number 440) or EPA's National Environmental Publication Information System (<http://nepis.epa.gov> at <http://nepis.epa.gov/Exe/ZyPURL.cgi?Dockey=20012QUZ.txt>).

[Sites accessed 7/28/2012; these sites may be moved or deleted later.]

Appendix 13.2:

Paint Chip Sampling

Dust sampling must always be done **before** paint chip sampling in order to minimize the prospect of cross-sample contamination. Paint chip sampling is a destructive method that may release a small quantity of lead dust. Although it is preferable to collect paint chip samples from inconspicuous areas, the occupant must always be notified that paint chip sampling may be necessary. This is particularly necessary in some risk assessments.

1. Paint Chip Sampling Tools and Materials

- A. Sharp stainless steel paint scraper.
- B. Disposable wipes for cleaning paint scraper.
- C. Non-sterilized non-powdered disposable gloves.
- D. Hard-shelled containers (such as non-sterilized 50-ml polypropylene centrifuge tubes) that can be rinsed quantitatively for paint chip samples if results are to be reported in mg/cm². Zip-type sealable baggies can be used only if results are to be reported in µg/g or percent by weight.
- E. Collection device (clean creased piece of paper or cleanable tray).
- F. Field sampling and laboratory submittal forms.
- G. Tape measure or ruler (if results are reported in mg/cm²).
- H. Ladder.
- I. Plastic trash bags.
- J. Flashlight.
- K. Adhesive tape.
- l. Heat gun or other heat source operating below 1100° F to soften the paint before removal.

2. Containment

- A. Method One: Plastic Sheeting Underneath Sampling Area

A clean sheet of plastic measuring four feet by four feet should be placed under the area to be sampled to capture any paint chips that are not captured by the collection device or creased piece of paper. Any visible paint chips falling to the plastic should be included in the sample. Dispose of the plastic after each sample is collected by placing the sheeting in a trash bag. Do not throw away the plastic at the dwelling. Wet wipes may be used to clean the area.

- B. Method Two: "Glovebag" Approach. If further containment is deemed necessary, a "glovebag" approach may be used. A durable sheet of plastic is loosely taped to the surface to be sampled, with a paint scraper, collection device, and shipment container housed inside the plastic. There should be enough "play" in the plastic to permit a scraping motion without dislodging the tape holding the

plastic to the surface. Large plastic baggies can be used in lieu of the sheet of plastic if paint chips are to be shipped to the lab in plastic baggies. Properly conducted, this method completely seals the surface during the actual scraping operation. A four by four foot sheet of plastic is still required under the glove bag to capture any debris that falls to the ground during the glove bag removal. The tape should be slowly removed from the surface to avoid lifting any additional paint off of the surface.

3. Paint Sample Collection

The paint chip sample need not be more than 2-4 square inches in size (consult with the laboratory for the optional size). Persons collecting paint chips should wear new disposable gloves for each sample.

The most common paint sampling method is to scrape paint directly off the substrate. The goal is to remove all layers of paint equally, but none of the substrate. A heat gun should be used to soften the paint before removal to reduce the chances of including substrate with the sample and to help prevent sample loss. Including substrate in the sample will dilute the lead content if results are reported in $\mu\text{g/g}$ or weight percent. Hold the heat gun no closer than six inches from the surface. Do not scorch the paint. Discontinue heating as soon as softening or blistering is observed. If you are only interested in layers that are not in good condition, you would only sample the damaged layers.

Use a razor-sharp scraper to remove paint from the substrate. Paint samples collected in this fashion are usually reported as a mass concentration in $\mu\text{g/g}$ or % lead only. The sample may be placed in a baggie or a hard-shelled container for shipment to the laboratory.

If the area sampled is measured exactly, and all the paint within that area can be removed and collected, it is possible to also report the results as the area concentration in mg/cm^2 , also known as the loading. All of the sample must be placed in a hard-shelled container for shipment to the laboratory. The hard-shelled container is used since the laboratory will analyze the entire sample submitted. The exact dimensions of the area sampled must be recorded on the field sampling form. If you will report the sample results as a loading, in mg/cm^2 , you must tell the laboratory in advance and have it report the weight of the whole sample, the mass concentration and the loading; in this case, including a small amount of substrate in the sample is permitted.

4. Composite Paint Chip Sample Collection

Whenever composite sampling is contemplated, consult with the analytical laboratory to determine if the laboratory is capable of analyzing composite samples and, if so, what wipes should be used and what annotation they add to analysis reports of composite samples. NLLAP accredited labs are required to note on the report that composite wipe analyses are not covered by their accreditation. This may cause problems with the admissibility of the data in any subsequent legal action.

Paint chip samples may be composited by collecting individual subsamples from different surfaces that are kept in separate sample containers, with appropriate directions to the laboratory concerning which samples are to be composited. Each subsample should contain enough material to perform a second individual analysis if needed.

No more than 5 subsamples should be included in the same sample container or zip-type sealable baggie. If both single-surface and composite samples are collected side-by-side, the individual samples can be submitted for analysis without returning to the dwelling if the composite result is above the composite standard. If the laboratory does not analyze the entire composite sample, it must use a validated homogenizing technique to ensure that all sub-samples are completely mixed together.

If results are reported as a loading in mg/cm², each subsample should be exactly the same size in surface area. If results are reported in weight percent or µg/g, the laboratory should ensure equal weights of each subsample is composited (weighing is done in a laboratory).

The result is then compared to the standard for lead-based paint divided by the number of sub-samples (the composite standard). If the result is above this number, one or more of the samples may be above the standard. Each sub-sample should be reanalyzed individually in this case. If the result is below this number, none of the sub-samples can contain lead above the standard.

5. Cleanup and Repair

- A. All settled dust generated must be cleaned up using wet wipes.
- B. The surface can be resealed with new paint if necessary. If desired, apply spackling and/or new paint to repair the area where paint was removed.
- C. Personnel conducting paint sampling should avoid hand-to-mouth contact (specifically, smoking, eating, drinking, and applying cosmetics) and should wash their hands with running water immediately after sampling. The inspector should ask to use the resident's bathroom for this purpose. Wet wipes may be used if no running water is available or if the bathroom is not available.

6. Laboratory Submittal

The samples should be submitted to a laboratory recognized by the EPA National Lead Laboratory Accreditation Program. See the NLLAP web site at <http://www.epa.gov/lead/pubs/nllap.htm>; it has a link to the current "monthly NLLAP list," at <http://www.epa.gov/lead/pubs/nllaplist.pdf>, of NLLAP-recognized laboratories. The list can also be obtained from the National Lead Information Center at 1-800-424-LEAD (5323); persons who have hearing or speech challenges may call this number using the Federal Relay Service at 1-800-877-8339 or by other of FedRelay's services listed at <http://www.gsa.gov/fedrelay>. Appropriate sample submittal forms should be used. The field sample number should appear on the field sampling form, the laboratory submittal form, and the container label. The name of the laboratory, the date the samples were sent to the laboratory, and all personnel handling the sample from the time of collection to the time of arrival at the laboratory should be recorded on a chain of custody form, if appropriate.

See Appendix 14 for the laboratory analytical procedures to be used.

7. Qualifications of Paint Sampling Technicians

All individuals performing paint sampling should be certified as lead-based paint inspectors or risk assessors. Where possible, field experience in environmental sampling is preferable.

8. Other Information

See ASTM E1729 on collecting paint chip samples (<http://www.astm.org/Standards/E1729.htm>) and E 1645 on laboratory preparation of paint-chip samples (<http://www.astm.org/Standards/E1645.htm>). [Accessed 7/28/2012; these sites may be moved or deleted later.]

Appendix 13.3:

Collecting Soil Samples for Lead Determination

1. Definitions

- A. *Bare soil* means soil or sand not covered by grass, sod, other live ground covers, wood chips, gravel, artificial turf, or similar covering.
- B. *Dripline/foundation area* means the area within 3 feet of the building wall surrounding the perimeter of a building.
- C. *Play area* means an area of frequent soil contact by children of less than 6 years of age as indicated by, but not limited to, such factors as the following: the presence of outdoor play equipment (e.g., sandboxes, swing sets, and sliding boards), toys, or other children's possessions, observations of play patterns, or information provided by parents, residents, care givers, or property owners.

2. Selecting Sampling Locations

A. Locations for composite samples.

Collect composite soil samples from bare soil in three locations, if bare soil is present in these locations: (1) play areas, (2) non-play areas in the dripline/foundation area, and (3) non-play areas in other parts of the yard. The number of samples to be collected depends on the size and characteristics of the property. See section II.G.3 of chapter 5 for recommendations.

B. Subsample locations.

The number of subsamples in a composite soil sample should be no more than ten. Generally, subsamples should be no closer to each other than 1 ft. (0.3 m) and no farther apart than 3 ft. (1.0 m), but exceptions to this general rule are not infrequent, due to wide variations in the pattern and extent of bare soil. The location and number of subsamples depends on the pattern and extent of bare soil in the area being sampled. In a relatively small contiguous area of, say, 10 sq. ft. (1.0 sq. m), a risk assessor might take one subsample from the center and one subsample from each of two different directions from the center for a total of three. If the area is larger, however, it would be reasonable to take more subsamples, more or less evenly spaced to represent the area. Or, if there is quite a bit of bare soil scattered in a linear pattern along the dripline/foundation area and extending all around the building, the risk assessor would most likely take 10 subsamples, more or less evenly spaced.

3. Alternative Collection Methods, General

Soil samples are collected with either a coring tool or a scooping technique. A coring tool is generally a tube of one-half to one inch in diameter that can be forced into the ground, with a plunger that, after the tube is removed from the ground, can push out all but the desired amount of soil. That which remains in the tube is then pushed out into a sample container. The coring method is the preferred method if soil characteristics allow, because it provides subsamples of uniform and reproducible size. It is not workable, however, if the soil is loose or sandy.

The scooping method employs a spoon or small scoop or centrifuge tube with which one collects a small amount of surface soil. Compared to the use of a coring tool, the scooping method may result in bias toward collecting greater amounts of soil close to the surface relative to below the surface because of the curvature of the scooping device. This method must be used, however, if the soil is loose or sandy, but extra care must be taken to assure that the subsamples are of uniform size.

Neither coring nor scooping may be feasible if the soil is frozen or very hard packed. In such cases efforts must be made to defrost or loosen the soil.

4. Equipment, Materials and Supplies

- A. *Coring tool.* There are several devices that may be used as a coring tool. Whatever is used, it must be strong enough to be pushed into the soil at hand, it should have a plunger to push out all soil in the tube but the desired sample and another plunger (or other mechanism) to push out the sample itself, and it must be cleanable. Coring tools often come with a "T" handle that can be attached to the tool or probe and used to push it into the ground, twisting if necessary to cut through roots or packed earth. A hammer attachment is also available on some coring tools to drive the probe into the ground. Professional coring tools come with disposable plastic liners. In soft soils, a disposable new plastic syringe at least one-half inch in diameter, with the end cut off, can be used for each composite sample.
- B. *Spoons, or plastic centrifuge tubes (50 mL),* for scooping.
- C. *Non-sterilized, non-powdered, disposable gloves.* Gloves should be non-powdered, because powder may contaminate the sample.
- D. *Wipes.* Wet wipes, such as baby wipes, with insignificant background levels of lead should be used to clean sampling equipment.
- E. *Plastic zip-type resealable bags that do not leak,* for soil sample containers. The bags should be between 1 quart to 1 gallon (or 1 to 4 liters), depending on amount of soil in the sample. Plastic centrifuge tubes with tight fitting caps may also be used as sample containers.
- F. *Measuring tape or ruler* (cleanable, and of adequate length to determine subsample locations).
- G. *Permanent ink marker.*
- H. *Pre-printed labels.*
- I. *Sample collection form.*
- J. *Laboratory submittal form.* This should be provided by the laboratory. Most laboratory submittal forms are also requests for analysis (an agreement between the submitter and the laboratory) and constitute a chain of custody record.
- K. *Trash bags or other receptacle* (do not use pockets or trash containers at the residence).
- L. *Site plan sketch* on which to indicate location of samples.

5. Core Sampling Procedure for Collecting a Composite Soil Sample

- A. Decide where the composite sample will be taken and identify the location on the site plan sketch.
- B. Decide where subsamples will be collected and mark the approximate locations.
- C. Don a new pair of clean, disposable, non-powdered gloves. A new pair of gloves should be put on before collecting each composite sample.
- D. Select a soil sample container (a plastic zip-type resealable bag, a centrifuge tube with a tightly fitting cap, or similar container) and affix a label with a pre-printed sample number on the container, or write the number on the container with the permanent ink marker. The date of sample collection should also be on the sample container. Write the sample number on the site plan sketch next to the location of the composite sample.
- E. Clean the coring tool, the plungers, and the end of the measuring tape if they have not been cleaned since the last sample collection. Clean with wet wipes.
- F. Check that one plunger of the coring tool is set correctly with a stop to remove all soil from the core except a sample from the top 1/2 inch (1.3 cm) of surface soil. Another plunger, without a stop, should be available to remove the sample.
- G. Drive the coring tool into the soil surface to a depth of approximately 2 inches (5 cm). No special effort should be made to collect visible paint chips. If paint chips are present, they should not be avoided and should be included in the sample. When sampling play areas, avoid including grass, twigs, stones, and other debris in the sample.
- H. Twist and remove the coring tool from the soil, retaining the soil in the tool.
- I. Using the plunger with the stop, push out all the soil except the top 1/2 inch (1.3 cm). Wipe off any excess soil from the probe, using a gloved finger.
- J. Using the plunger without the stop, push the soil sample out of the core into the labeled soil sample container.
- K. Collect the other subsamples, using steps "F" through "J," depositing all the subsamples into the same container.
- L. Tightly close the container, using the zip-type resealable bag or twist-cap as applicable.
- M. Check to make sure the container is correctly labeled and that the sample number appears correctly on the site plan sketch.
- N. Don a new pair of clean, disposable, non-powdered gloves and clean the coring tool and plungers with wet wipes. Discard the wipes and gloves in the trash bag for proper disposal away from the site.

6. Scooping Procedure for Collecting a Composite Soil Sample

A. Scoop sampling using a spoon:

1. Don a new pair of clean, disposable, non-powdered gloves.
2. Select a soil sample container (a plastic zip-type resealable bag, a centrifuge tube with a tightly fitting cap, or similar container) and affix a label with a pre-printed sample number on the container, or write the number on the container with the permanent ink marker. The date of sample collection should also be on the sample container. Write the sample number on the site plan sketch next to the location of the composite sample.
3. Clean the spoon, if it hasn't been cleaned since the last composite sampling. Use wet wipes to clean.
4. Using the clean spoon and the measuring tape, dig a small test hole near the subsample location to a depth of 1/2 inches (1.3 cm). Use this hole as a visual aid in collecting subsamples to the correct depth of 1/2 inches (1.3 cm).
5. Collect soil into the sample container by scooping soil out of a hole 1/2 inches (1.3 cm) deep and approximately 2 inches (5 cm) in diameter.
6. Collect all subsamples in like manner, compositing all subsamples into the same container.
7. Tightly close the soil sample container, using the zip-type resealable bag or twist-cap as applicable.
8. Check to make sure the container is correctly labeled and that the sample number appears correctly on the site plan sketch.
9. Don a new pair of clean, disposable, non-powdered gloves and clean the spoon with wet wipes. Collect the wipes and gloves in the trash bag for proper disposal away from the site.

B. Scoop sampling using a plastic centrifuge tube:

1. Don a new pair of clean, disposable, non-powdered gloves.
2. Select a soil sample container (a plastic zip-type resealable bag, a centrifuge tube with a tightly fitting cap, or similar container) and affix a label with a pre-printed sample number on the container, or write the number on the container with the permanent ink marker. The date of sample collection should also be on the sample container. Write the sample number on the site plan sketch next to the location of the composite sample.
3. Using the measuring tape and an unlabeled closed centrifuge tube, determine how deep to place the tube on its side in order to collect a sample that includes soil at a depth of 1/2 inches (1.3 cm). Mark the sides of the tube when it is at the correct depth. This centrifuge tube is the collection tube for the composite sample.
4. Remove the cap of the collection tube and insert its open end into the soil at the location of the subsample to the desired depth, as indicated by the mark on the side of the tube. Push or pull the tube through the soil, maintaining the desired depth, for approximately 4 to 5 inches (10 to 13 cm).

5. Remove the collection tube from the soil and pour the soil subsample into the labeled soil sample container. Alternatively, use the tube as the subsample container. Most laboratories accept a number of subsamples in tubes that they then composite into the sample that is prepared for extraction and analysis.
6. Using the collection tube, collect other subsamples, following steps 4 and 5.
7. Tightly close the soil sample container, using the zip-type resealable bag or twist-cap as applicable.
8. Check to make sure the container is correctly labeled and that the sample number appears correctly on the site plan sketch.

7. Reporting and Laboratory Submittal

- A. Complete the sample collection form, such as Form 5.5, in chapter 5. The form should include the client name and address, an explanation of the sample collection method used, an individual and unique sample number and date of collection for each composite sample, and the name of the person who collected each sample.
- B. Attach the site plan sketch to the sample collection form.
- C. Complete the laboratory submittal form, making sure that the sample numbers match those on the sample containers.
- D. Submit the samples with the laboratory submittal form.

8. Additional Information

Additional information on soil sampling methods can be found in E1727 Standard Practice for Field Collection of Soil Samples for Subsequent Lead Determination (<http://www.astm.org/Standards/E1727.htm>), and in the EPA report, *Residential Sampling for Lead: Protocols for Dust and Soil Sampling*, March 1995 (EPA 747-R-95-001) available from the National Lead Information Center (<http://www.epa.gov/lead/pubs/nlicdocs.htm>; document number 440) or EPA's National Environmental Publication Information System (<http://nepis.epa.gov>) at <http://nepis.epa.gov/Exe/ZyPURL.cgi?Dockey=20012QUZ.txt>. [Accessed 7/28/2012; these sites may be moved or deleted later.]

Appendix 13.4: (Reserved for Future Use)

Appendix 13.4 of the 1995 *Guidelines* was a procedure for sampling airborne particulate for lead has been deleted because it is considered outside of the scope of these *Guidelines*.

Refer to NIOSH Analytical Method 7082, at <http://www.cdc.gov/niosh/docs/2003-154/pdfs/7082.pdf>.
[Accessed 7/28/2012; this site may be moved or deleted later.]

Appendix 13.5: EPA Information on Drinking Water

The EPA two page pamphlet on lead is attached. It is available on the web at http://www.epa.gov/safewater/lead/pdfs/fs_leadindrinkingwater_2005.pdf.

For additional information, visit EPA's Ground Water and Drinking Water home page, <http://www.epa.gov/safewater/>.

[Both pages accessed 7/28/2012; these sites may be moved or deleted later.]

WHAT IS LEAD?

- Lead is a toxic metal that is harmful if inhaled or swallowed.
- Lead can be found in air, soil, dust, food, and water.

HOW CAN I BE EXPOSED TO LEAD?

- The greatest exposure to lead is swallowing or breathing in lead paint chips and dust.
- Lead also can be found in some household plumbing materials and water service lines.

WHO IS AT RISK?

- Children ages 6 and under are at the greatest risk. Pregnant women and nursing mothers should avoid exposure to lead to protect their children.
- Exposure to lead can result in delays in physical and mental development. Your child is also at risk if:
 - your home or a home that your child spends a lot of time in was built before lead paint was banned in 1978.
 - renovation work is being done in such a home.
 - the adults in the home work with lead.

HOTLINES & INFORMATION

EPA Safe Drinking Water Hotline:
800-426-4791

National Lead Information Center:
800-424-LEAD
www.epa.gov/lead

NSF International:
www.nsf.org

Lead in Drinking Water Web Site:
www.epa.gov/safewater/lead

Additional Information:

Read the annual report you get from your water utility to find out about how they are working to reduce levels of lead in drinking water and other information about your drinking water. Call them if you have any questions.

Contact your local public health department or talk to your doctor about reducing your family's exposure to lead.

Office of Water (4606 M)
EPA 816-F-05-001
February 2005

Printed on Recycled Paper



IS THERE LEAD IN MY DRINKING WATER?

You can reduce the risk of lead exposure from drinking water in your home.



Tips For Protecting Your Family's Health

HOW DOES LEAD GET INTO WATER?

Lead enters the water ("leaches") through contact with the plumbing.

Lead leaches into water through:

- Corrosion* of
 - Pipes
 - Solder
 - Fixtures and Faucets (brass)
 - Fittings

*Corrosion is a dissolving or wearing away of metal caused by a chemical reaction between water and your plumbing.

The amount of lead in your water also depends on the types and amounts of minerals in the water, how long the water stays in the pipes, the amount of wear in the pipes, the water's acidity and its temperature.

HEALTH TIP

To help block the storage of lead in your child's body, serve your family meals that are low in fat and high in calcium and iron, including dairy products and green vegetables.



What should I do if I suspect that my water contains high lead levels?

- If you want to know if your home's drinking water contains unsafe levels of lead, have your water tested.
- Testing is the only way to confirm if lead is present or absent.
- Most water systems test for lead as a regular part of water monitoring. These tests give a system-wide picture and do not reflect conditions at a specific drinking water outlet.
- For more information on testing your water, call EPA's Safe Drinking Water Hotline at 800-426-4791.

Should I test my children for exposure to lead?

- Children at risk of exposure to lead should be tested.
- Your doctor or local health center can perform a simple blood test to determine your child's blood-lead level.
- If your child has a blood lead level at or above 10ug/dl, should take preventive measures.

QUICK TIPS TO REDUCE YOUR FAMILY'S EXPOSURE TO LEAD



Boiling your water will not get rid of lead.

- Use cold water for drinking or cooking. Never cook or mix infant formula using hot water from the tap.
- Make it a practice to **run the water at each tap** before use.
- Do not consume water that has sat in your home's plumbing for more than six hours. First, make sure to **run the water** until you feel the temperature change before cooking, drinking, or brushing your teeth, unless otherwise instructed by your utility.
- Some faucet and pitcher filters can remove lead from drinking water. If you use a filter, be sure you get one that is certified to remove lead by the NSF International.

Appendix 14.1: EPA-Recognized Laboratories for Analysis of Lead in Paint, Dust, and Soil

For an explanation of the National Lead Laboratory Accreditation Program (NLLAP) and a list of NLLAP-recognized laboratories, see the EPA website at <http://www.epa.gov/lead/pubs/nllap.htm>. The monthly updated list of NLLAP-recognized laboratories is at <http://www.epa.gov/lead/pubs/nllaplist.pdf>. [Accessed 7/28/2012; these sites may be moved or deleted later.]

Appendix 14.2: **(Reserved for future use)**

Appendix 14.2 of the 1995 *Guidelines*, which was a procedure for the digestion of wipe samples using diaper wipes, has been deleted. For information on analytical procedures, refer to ASTM, NIOSH and EPA methods and standards.

Appendix 14.3:

Procedure for the Preparation of Field Spiked Wipe Samples

On a routine basis, lead risk assessors should randomly insert spiked samples (samples with known amounts of the analyte(s) of interest) into their submissions for laboratory analysis. Spiked samples help show to what extent the laboratory's analytical method is working, and help assess the accuracy of the method and/or the analyst. Submission of the spiked samples is recommended to determine if the laboratory digestion procedure is capable of achieving recovery rates between 80 and 120% for the specific brand of wipe used in the field. Some reports indicate that recovery rates can be as low as 40% using certain types of wipes. These field spiked samples are in addition to those the laboratory prepares for laboratory's own internal QA/QC program. The samples are not actually prepared in the field, but are manufactured under laboratory conditions. They are then relabeled in the field and inserted into the sample stream in a random and blind fashion. The spikes should be prepared using wipes from the same lot as that used in the field, since recoveries can vary by lot. The lot should be analyzed before use to ensure that there is not background contamination.

As of July 2012, spiked wipe samples using wipe sampling media that meet ASTM E 1792 specifications are available for a price from American Industrial Hygiene Association (AIHA) Proficiency Analytical Testing Programs, LLC: go to <http://admin.aihaaccreditedlabs.org/AccredPrograms/ELLAP/Pages/default.aspx> for further information.

An alternate source of samples available for a price is the National Institute of Standards and Technology (NIST) Standard Reference Materials (SRM) Catalog (<http://www.nist.gov/ts/msd/srm/index.cfm>; search for "Lead in Paint").

The NIST web page, Lead in Paint, Dust, and Soil (powder and sheet forms), "Table 105.13" (<https://www-s.nist.gov/srmors/viewTable.cfm?tableid=55>), describes NIST lead SRMs for these three media. As of July 2012, the catalog said that, "These SRMs and RM have been developed in conjunction with the U.S. EPA to monitor paint, soil, and dust sources of lead." It further describes the lead in dust SRMs as follows: "SRMs 2580, 2581, 2582, and 2589 consist of paint that has been ground and homogenized into a powder, 99+% of which passes a 100mm sieve. SRM 2583 and SRM 2584 consist of dust, 99+% of which passes a 100mm sieve, that was collected in vacuum cleaner bags during cleaning of dwelling interiors. SRM 2583 and SRM 2584 are certified for arsenic, chromium, cadmium, lead, and mercury. SRMs 2584, 2586, and 2587 are dust or soil matrices containing lead from paint." **The list of lead in dust SRMs described under Table 105.13, as of 7/28/2012, some of which may not be available subsequently, is:**

SRM Description

2580	<i>Powdered Paint Nominal 4% Lead</i>
2581	<i>Powdered Paint Nominal 0.5 % Lead</i>
2582	<i>Powdered Paint Nominal 200mg/kg Lead</i>
2583	<i>Trace Elements in Indoor Dust</i>
2584	<i>Trace Elements in Indoor Dust</i>
2589	<i>Powdered Paint Nominal 10% Lead</i>

You may search for individual SRMs at <http://www-s.nist.gov/srmors/>, searching for dust, lead, soil, trace elements, etc. [Accessed 7/28/2012; the sites above may be moved or deleted later.]

The following procedure may be used to prepare spiked wipe samples.

1. If it is necessary to prepare spiked wipe samples, use the same brand of wet wipes that will actually be used in the field.
2. Obtain a NIST Standard Reference Material containing a certified concentration of lead, or a traceable secondary standard with a known amount of lead in dust.
3. Weigh out between 50 and 500 μg of lead (not total dust) to the nearest microgram.
4. Don a new disposable glove to handle each new wipe sample.
5. If tared weighing boats are used, quantitatively transfer all of the material from the boat to the wipe by wiping the boat thoroughly.
6. If glassine paper is used, be certain that the dust transfer was complete.
7. Do not let the wipe touch any other surface. Fold the wipe with the spiked side inward and carefully insert it into a non-sterilized 50 ml centrifuge tube or other hard-shelled container that is identical to the containers that will hold the field samples. The containers holding the spiked samples should be indistinguishable from those holding the field samples so that the analysis can be performed blindly. This means the same container or tube should be used to hold field samples and wipe samples.
8. Have the spiked sample inserted into the sample stream randomly, with at least one spiked sample for each 50 field samples analyzed and one blank for each sample batch.

Appendix 15:

OSHA Lead in Construction Guidance

Because OSHA standards, interpretations, and enforcement policy may change over time, users are encouraged to: read the full text of the OSHA Lead in Construction standard (29 CFR 1926.62) in the latest edition of the code of federal regulations (CFR); periodically consult OSHA's website at <http://www.osha.gov>, such as for the documents below (or their successors); and, seek appropriate legal counsel.

1. The fact sheet taken from the Occupational Safety and Health Administration (OSHA) web site at <http://www.osha.gov/Publications/osha3142.html>.
2. OSHA's compliance guide, OSHA Instruction CPL 02-02-058 (old directive number CPL 2-2.58) - 29 CFR 1926.62, Lead Exposure in Construction; Interim Final Rule – Inspection and Compliance Procedures, at http://www.osha.gov/pls/oshaweb/owadisp.show_document?p_table=DIRECTIVES&p_id=1570.
3. OSHA's Letter regarding Showers and the Lead in Construction Standard, at http://www.osha.gov/pls/oshaweb/owadisp.show_document?p_table=INTERPRETATIONS&p_id=21914.
4. Additional information from a search of the OSHA website (<http://www.osha.gov/>) using the phrase "lead in construction" (including the quotation marks), at: http://www.osha.gov/pls/oshaweb/searchresults.relevance?p_text=%22lead%20in%20construction%22&p_start=0&p_finish=15&p_direction=Next.

[All sites accessed 7/28/2012; the sites may be moved or deleted later.]

Appendix 16: CDC Guidance on Lead Poisoning Prevention

For information on the CDC Childhood Lead Poisoning Prevention Program, see the CDC lead homepage at <http://www.cdc.gov/nceh/lead/>

As of July 27, 2012, the website included links to:

- ◆ Prevention Tips (<http://www.cdc.gov/nceh/lead/tips.htm>)
- ◆ Policy Resources (<http://www.cdc.gov/nceh/lead/policy.htm>)
- ◆ Calendar (<http://www.cdc.gov/nceh/lead/calendar.htm>)
- ◆ CDC's Childhood Lead Poisoning Prevention Program (<http://www.cdc.gov/nceh/lead/about/program.htm>)
- ◆ Data, Statistics, and Surveillance (<http://www.cdc.gov/nceh/lead/data/index.htm>)
- ◆ Publications (<http://www.cdc.gov/nceh/lead/publications>)
- ◆ Tools and Training (<http://www.cdc.gov/nceh/lead/toolstraining.htm>)
- ◆ Partners (<http://www.cdc.gov/nceh/lead/partners.htm>)

as well as links for:

- ◆ Lead in the workplace: CDC *National Institute for Occupational Safety and Health* page on the *Adult Blood Lead Epidemiology Surveillance Program/ National Institute for Occupational Safety and Health (ABLES/ NIOSH)* (<http://www.cdc.gov/niosh/topics/ABLES/ables.html>)
- ◆ Lead in the environment: CDC *Agency for Toxic Substances and Disease Registry (ATSDR)* lead page (<http://www.atsdr.cdc.gov/substances/toxsubstance.asp?toxid=22>)
- ◆ *HUD's* lead and healthy homes homepage (<http://www.hud.gov/offices/lead/>)
- ◆ *EPA's* lead homepage (<http://www.epa.gov/opptintr/lead/index.html>)

and additional information.

[These sites were accessed 7/28/2012; they may be moved or deleted later.]